



BOSCH

Building Integration System

en

Configuration Guide

Table of contents

1	Using Help	7
2	Short Information	9
2.1	Intended audience	9
3	System Overview	10
3.1	BIS single server systems	10
3.2	BIS multi-server systems	11
4	Overview of the Configuration Browser UI	14
4.1	Basic layout of the Configuration Browser	14
4.2	The menu structure of the Configuration Browser	15
4.3	Working with lists and large numbers of data	18
4.4	Customizing BIS Configurator Outlook buttons	19
4.5	Symbols used in the BIS Configuration Browser	20
5	General configuration concepts and activities	22
5.1	Overview of BIS configuration	22
5.2	Prerequisites of configuration	25
5.3	Licensing the BIS server	25
5.4	Starting and stopping the BIS server	26
5.5	Starting and stopping the BIS Configuration Browser	29
5.6	Setting up an initial BIS configuration	30
5.7	Creating a new configuration	35
5.8	Opening (loading), saving and copying configurations	35
5.9	Configuration printouts	40
5.10	System operators	40
5.10.1	Operators with authorizations on all or on IP-filtered workstations	41
5.10.2	Operators with authorizations on selected workstations	42
5.10.3	Setting up an Active Directory user as an operator	44
5.11	OPC classic connections	45
5.12	OPC UA connections	48
5.12.1	Adding an OPC UA server using the Local Discovery Server	48
5.12.2	Adding an OPC UA server manually (without the Local Discovery Server)	48
5.12.3	Browsing OPC UA items into the BIS configuration	49
5.13	Exporting detector data	51
5.14	Diagnostic tools and event simulation	51
5.15	Structure and organization of the configurations	52
6	OPC: BIS Connector	54
6.1	Introduction and overview	54
6.2	Installation and configuration	55
6.2.1	TransformationTypes.xml	55
6.2.2	OPCConnector.xml	59
6.3	Invocation from BIS	63
7	Common configuration recipes	66
7.1	Configuration A: A basic BIS configuration	66
7.2	Configuration B: Includes enhancements from the basic package.	67
7.3	Configuration C: Adds active location plans (floor plans) to configuration B.	68
7.4	Configuration D: Adds dynamic html pages (e.g. action plans) to configuration C.	69
8	Template jobs	70
8.1	Introduction and overview	70
8.2	Prerequisite software	70

8.3	Creating a connection to the Template Job OPC server	70
8.4	Using placeholders for addresses and states in a job	71
8.5	Marking a job as a Template Job	72
8.6	Exporting placeholder data to an Excel file	72
8.7	Entering real addresses and states in the Excel file	74
8.8	Checking the consistency of the Excel file	75
8.9	Importing addresses and states from an Excel file	75
8.10	Notes and Limitations	76
9	Customizing BIS operator interfaces	77
9.1	Authentication	77
9.2	Configuring location plans (floor plans)	77
9.2.1	Creating location plans	77
9.2.2	Best practices for creating location plans	78
9.2.3	Defining named sections	78
9.2.4	Anchoring detectors in graphics using hyperlinks	78
9.2.5	Saving the floor plan for use in the BIS client	79
9.3	Creating/Editing Action Plans and Action Buttons	80
9.4	Setting up Workflows	84
9.5	Creating/Modifying Workstation-Specific Interfaces	84
9.6	Advanced BIS scripting options	87
9.6.1	Subscribe to Address States Using JavaScript	87
9.6.2	Change Location Tree Selection Using JavaScript	87
9.7	Displaying raw OPC data	88
9.8	HTML5	90
10	BIS multi-server systems	92
10.1	Providing information to other BIS single server systems	92
10.2	Consuming information from other BIS single server systems	95
10.3	Current limitations	96
10.4	Upgrading a BIS 4.0 multi-server system	97
11	Optional BIS configuration tools	99
11.1	NetLimiter Tool	99
11.2	ClientInfo Tool	100
11.3	Using the ChangePassword tool	100
11.4	Microsoft SQL Server Report Builder 3.0	102
11.5	.NET Framework 2.0	102
12	BIS Manager tabs	103
12.1	The BIS Manager	103
12.2	The System Start/Stop tab	103
12.3	The Transmit Message tab	105
12.4	The Event log tab	105
12.4.1	Updating the Event log database (Database migration)	107
12.4.2	Event log Administrator Settings	110
12.5	The Backup/Restore Configuration tab	112
12.6	The Load-Save Configuration tab	113
12.7	The License tab	113
12.8	The Error Log tab	113
12.9	The Version tab	114
13	Configuration Browser tabs	115
13.1	License	115





13.2	Server structure	116
13.3	Information	118
13.4	Authorizations	118
13.4.1	Setting Authorizations for location nodes	121
13.5	Operators	124
13.6	Audit trail	125
13.6.1	Enabling HTTPS for Audit trail (optional)	126
13.6.2	Configuring the Audit trail feature	126
13.6.3	Using the Audit trail feature	127
13.6.4	Audit trail performance	129
13.7	Divisions	129
13.8	Tree structure	130
13.8.1	Building the Location Tree	132
13.8.2	Assigning graphic files and their layers to nodes in the location tree	132
13.8.3	Assigning action plans and miscellaneous documents to nodes in the location tree	133
13.8.4	Assigning automatic alarm printouts to nodes in the location tree	134
13.9	Connections and Addresses	135
13.9.1	Addresses	135
13.9.2	Creating connections and addresses by browsing	136
13.9.3	Disabling / Enabling connections	139
13.9.4	Reloading OPC connections	139
13.10	Detector placement	141
13.10.1	Controlling layer visibility through states	144
13.11	States	145
13.12	Detector type	149
13.13	Symbols and symbol-blinking	157
13.14	Application Launcher	159
13.15	Virtual device	160
13.15.1	Example: Configuration of a Virtual Device	162
13.16	Address lists	167
13.17	Timer	170
13.18	Associations (Jobs) - an overview	173
13.18.1	Elements of Associations	175
13.19	General procedure for configuring Associations	178
13.20	Message timeouts, distribution and escalation	179
13.21	Examples of Associations	180
13.21.1	Example of tracking totals using Associations	180
13.21.2	Example of configuring a security system using Associations	182
13.21.3	Example of automatic backup of the event log using Associations	183
13.21.4	Example of an Association using “monitored by camera”	184
13.22	Backing up the configuration	187
13.23	Device state/condition counters	192
13.24	Event log	194
13.25	Alarm print	196
13.26	Protocol print	198
13.27	Tools	199
13.27.1	Engine-specific tools	200
13.27.2	Remote site configuration	201
13.27.3	Distributed reports configuration	201

Glossary	205
Index	207

1 Using Help



How to use this help file.

Tool bar buttons

Button	Function	Description
	Hide	Click this button to hide the navigation pane (Contents, Index and Search tabs), leaving only the help pane visible.
	Show	When the Hide button is clicked it is replaced by the Show button. Click this button to reopen the Navigation pane.
	Back	Click this button to move back through the chain of topics most recently viewed.
	Forward	Click this button to move forward again through the same chain of topics
	Print	Click this button to print. Choose between "Print the selected topic," and "Print the selected heading and all subtopics".

Tabs

Contents

This tab displays a hierarchical table-of-contents. Click a book icon  to open it  and then click on a topic icon  to view the topic.

Index

This tab displays an index of terms in alphabetical order. Select a topic from the list or type in a word to find the topic(s) containing it.

Search

Use this tab to find any text. Enter text in the field and then click button: **List Topics** to find topics that contain all the words entered.

Resizing the help window

Drag the corner or edge of the window to the desired size.

Further conventions used in this documentation

- Literal text (labels) from the UI appears in **bold**.
E.g. **Tools, File, Save As...**
- Sequences of clicks are concatenated using the > character (the greater-than sign).
E.g. **File > New > Folder**
- Changes of control-type (e.g. menu, radio-button, check box, tab) within a sequence are indicated just before the label of the control.
E.g. Click menu: **Extra > Options > tab: View**
- Key combinations are written in two ways:

- Ctrl+Z means hold down the first key while pressing the second
- Alt, C means press and release the first key, then press the second
- The functions of icon buttons are added in square brackets after the icon itself.
E.g. [Save]

2 Short Information

This document is the BIS Configuration guide. It describes the **configuration** of the Building Integration System (BIS) from Bosch Security Systems.

For a BIS user guide (information about operating BIS) please consult the separate BIS Operation guide.

2.1 Intended audience

Configurators and administrators of BIS systems. As as BIS administrator you should already understand the following topics:

- The local security requirements of your site, and how these are to be mapped onto the BIS system infrastructure.
- The OPC systems that deliver the data which BIS is to manage.
- System management including network and OPC data communications.

3 System Overview

Building Integration System (BIS) is a comprehensive browser-based building management solution. It combines access control, building safety (fire, intrusion) and site-monitoring (CCTV) systems in a single user interface. Developed according to OPC (Open Platform Communications*) standards, BIS easily integrates OPC-compliant systems.

***) Note:** This is the new definition of the OPC acronym by the OPC foundation, as of November 2011.

System topologies: single vs. multi-server

- A **BIS single server system** contains one computer called the BIS Login Server, also known simply as the BIS server.
 - Each BIS server can act as a communications hub for zero or more connection servers and database servers, which are separate computers.
 - Either the BIS server runs OPC and database server software by itself, or this software runs on separate connection and database server computers. **Note:** As long as there is only one BIS server, the system is known as a single server system.
- A **BIS multi-server system** is where two or more BIS single-server systems cooperate in a network
 - The individual BIS servers in the network can be providers or consumers of each other's data, or both provider and consumer simultaneously.
 - Thus a multi-server system can be hierarchical or peer-to-peer in its structure.

3.1 BIS single server systems

Definition

A single server BIS system contains only one BIS login server (also known as the BIS server). It may run OPC servers itself, and it may contain zero or more Connection servers and Database server computers.

Illustration

BIS installations vary enormously in size and complexity. The following illustrates a small and a complex BIS single-server installation.



Figure 3.1: A small single server BIS system

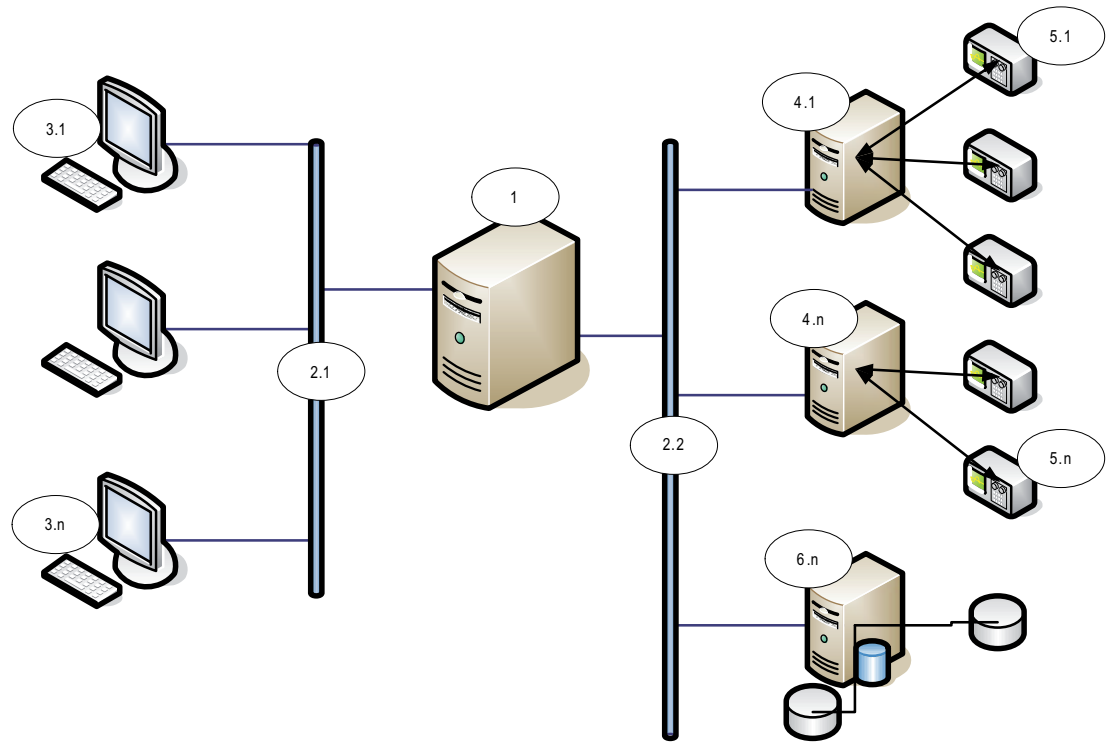

Figure 3.2: A complex single server BIS system

No.	Name	Function
1	BIS (Login) server	Runs the BIS application. The BIS server functions as an OPC client
2.1 to 2.n	Network(s)	Carries signals
3.1 to 3.n	BIS Client Workstation(s)	Runs the BIS user interface
4.1 to 4.n	Connection server(s)	Runs OPC server processes
5.1 to 5.n	OPC device(s)	Interacts with the outside world
6.1 to 6.n	Database server	Hosts BIS data for event log and engines

3.2 BIS multi-server systems

Definition

A multi-server BIS system is one in which two or more BIS single server systems share information. BIS multi-server systems can be organized as hierarchical or peer-to-peer networks.

Implementation overview

Participating BIS single-server systems can be providers of information, consumers of information, or both simultaneously.

- The Provider server creates a configuration file that details exactly which information it should share with others.

- The Consumer server configures and browses the provider server as a remote OPC server.

Any or all of the information monitored by the provider can be passed to the consumer or consumers. Typically the information consists of OPC addresses, state-changes, commands and alarms.

Illustration

For simplicity, the following illustrates the interaction of one provider and one consumer server. The size and complexity of the multi-server BIS system is limited by the network traffic and the capacity of the consumer servers to process incoming data.

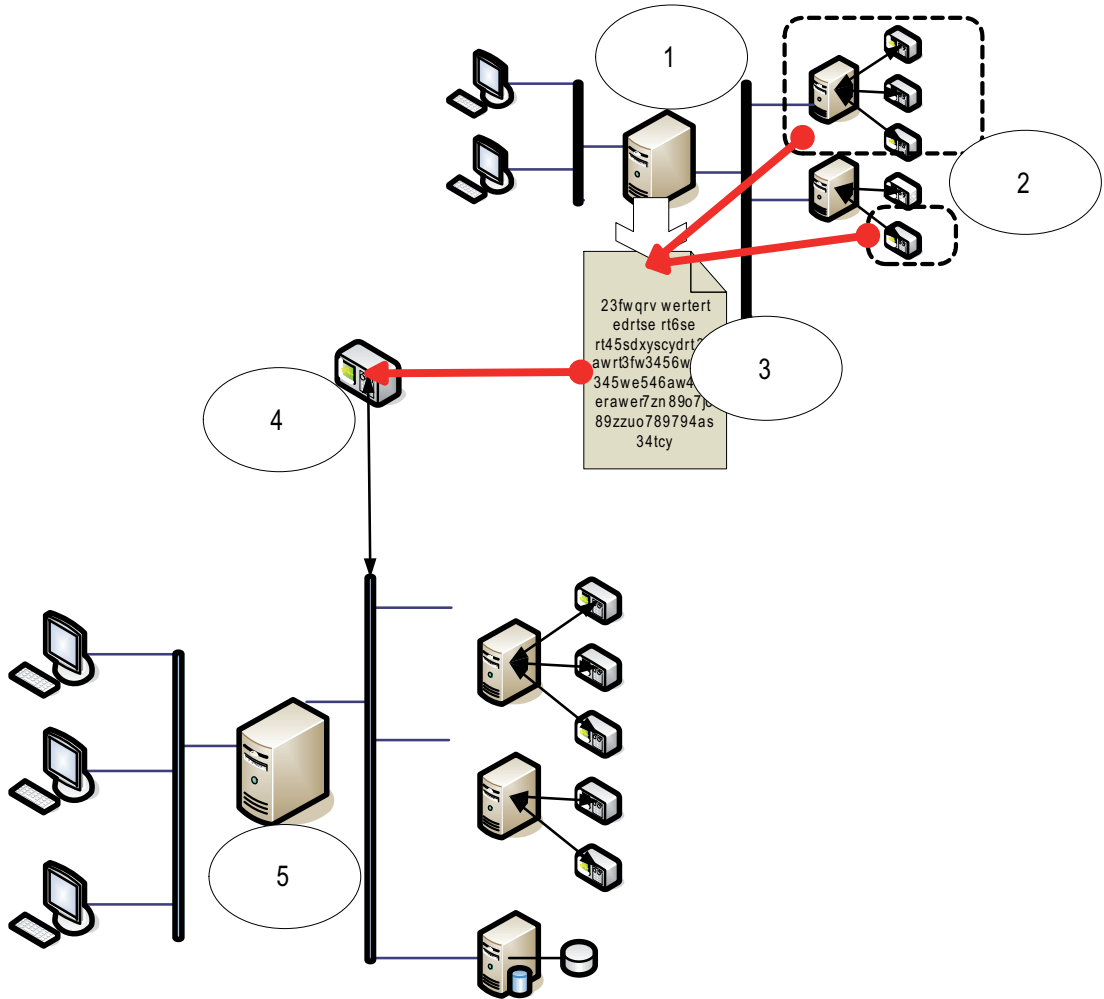

No.	Name	Function
1	The provider server	A kind of BIS server that provides information to other BIS single server systems
2	The subset of the addresses that the provider server should share	
3	The encrypted configuration file generated by the provider server	Describes the subset of information that the provider server should share

No.	Name	Function
4	An OPC server of type BIS Remote System	Acts as an interface between the provider server and the consumer server. It is configured on the consumer server using the encrypted configuration file, and then browsed like any other connection server.
5	The consumer server	This BIS server receives and processes information from its own devices, and those of connected provider servers

4 Overview of the Configuration Browser UI

4.1 Basic layout of the Configuration Browser

The various parts of the Configuration Browser user interface are referred to as follows.

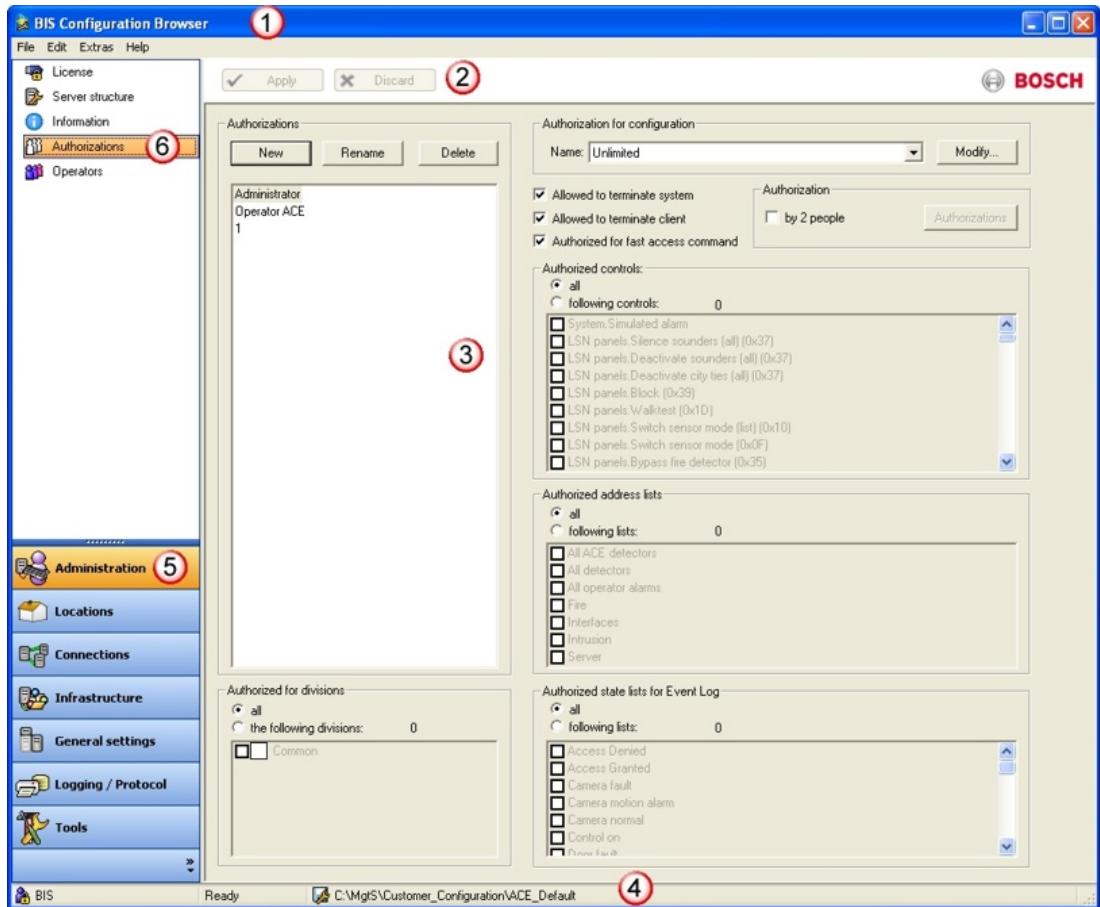

Overview of Configuration Browser menus.

Label	Description
(1)	The Title bar contains the name of the application plus windows controls to minimize, maximize and close it.
(2)	The Tool bar contains the buttons Apply and Discard , which do not become active until settings have been changed in the Dialog field (3). Before another dialog can be opened the changes must be either committed or discarded.
(3)	The main Dialog field which changes its layout depending on which dialog is selected in the Dialog bar (6)
(4)	The Status bar displays information about the currently loaded configuration.
(5)	The lower left section of the BIS Configuration Browser window contains the Outlook bar : a set of tabs, arranged vertically as in Microsoft Outlook, which can be opened by single-clicking.
(6)	The various dialogs belonging to these tabs are then displayed in the Dialog bar .

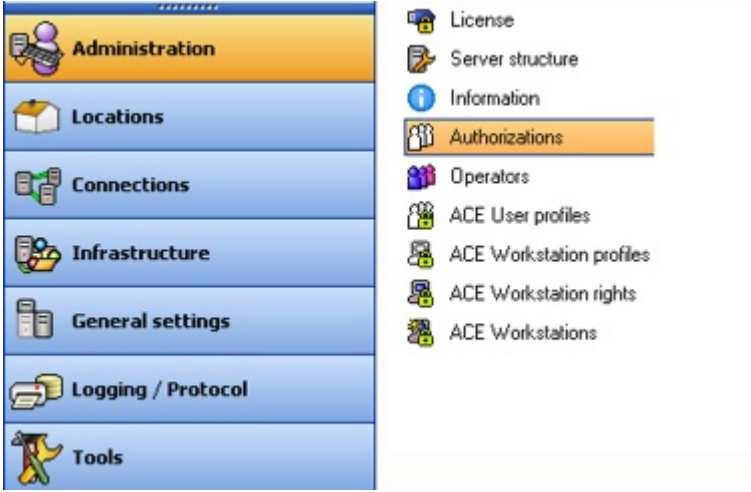
Label	Description
	A single click on one of these dialogs will bring its contents up in the Dialog field (3).
(5) & (6)	<p>The currently active Outlook tab (5) and its associated dialog (6) are highlighted in color.</p> 

4.2 The menu structure of the Configuration Browser

The table below gives an overview of which activities can be carried out in which menus:

Tab	Application/ Dialog	Description	Notes
Administration	License	Reads and displays the contents of a license file.	
	Server structure	Configures and administers rights on the system server.	
	Information	Contains program and configuration versions plus customer data if applicable.	
	Authorizations	Configures bundles of user-rights, known as Authorizations. These can be assigned to BIS operators in the Operators dialog.	
	Operators	Assigns Authorizations to BIS and Access Engine users.	
	Active directory configuration	Maps an Active directory server and active directory groups to BIS Authorizations	

	Audit trail configuration	Starts and stops a protocol of all changes to the BIS configuration, and manages how its storage space is used.	
	Audit trail reporting	Displays and searches the Audit trail.	
	ACE User profiles	Defines user profiles based on job functions	Special dialogs for Access Engine.
	ACE Workstation profiles	Sets up workstation profiles based job functions and user profiles	
	ACE Workstation rights	Defines dialog views per workstation	
	ACE Workstations	Creates and configures new workstations for Access Engine	
Locations	Divisions	Creates and edits divisions within the access-controlled area.	
	Tree structure	Configures the device hierarchy and assigns of location plans to it.	
	Detector placement	Maps detectors to locations	
	ACE Areas	Configures Areas and parking lots	Special dialog for Access Engine.
Connections	Connection Servers	Topmost node of the server structure. OPC servers are displayed below their respective connection servers. For example Access Engine is the connection server for access control functionality.	
Infrastructure	Detector types	Defines and configures detector types	
	States	Configures and assigns detector states	
	ACE PIN Codes	Defines PIN code parameters (e.g. retry limit, length)	Special dialogs for Access Engine.
	ACE Card coding config.	Defines standard values for card data	
	ACE Card reader	Creates and configures card readers	

	ACE Card definition	Creates and configures card data encodings	
	ACE Custom fields	Creates and configures additional data fields for the ACE dialog Persons .	
General Settings	Virtual Device	Groups multiple detectors to one virtual device.	
	Address lists	Groups multiple addresses together into lists so that they can be controlled together.	
	Timer	Creates time schedules so that controls can be executed automatically at certain times on certain days.	
	Associations	Associates messages and state-changes with responses.	
	Counters	Display summaries of device states	
Logging/ Protocol	Event log	Collects all system events and provides a means of finding and filtering them.	
	Alarm print	Defines printers and print-templates for workstations	
	Protocol print	Defines the contents of protocols.	
Tools	ACE Badge Designer	Creates badge layouts for access control. This program has its own online help.	Special dialog for Access Engine. These applications have their own on line helps.
	ACE Configuration import/export	Configures import and export data This program has its own online help.	
	ACE System parameter editor	Displays and Edits system parameters for access control.	
	ACE Configuration Card Personalization	Configures the badge creation program for access control.	

ACE Configuration AMC IP addresses	Configures IP-Addresses for AMCs [access control data].	
VIE Configuration	Configures the Video Engine.	Special dialog for Video Engine. Described in the Video Engine help file that is linked to this help file if VIE is installed..
Remote site configuration	Creates the encrypted configuration files for Provider servers, that is, servers which make some or all of their addresses visible to Consumer servers	
Distributed report configuration	Configures a special event log report that contains events from multiple networked BIS servers	

4.3 Working with lists and large numbers of data

Many of the dialogs in the Configuration Browser contain lists with potentially high numbers of elements.

In order to work more effectively with such lists BIS supports, where appropriate, the common MS Windows idioms for the selection of list elements.

- **Single selection**
Click once on a list element
- **Multiple selection...**
 - ...of contiguous elements
Click once on a list element then click another element in the same list whilst holding the **Shift** key. Both elements and all intervening elements will be selected.
 - ...of discontinuous elements
Hold the **Ctrl** key and click to select or deselect multiple discontinuous elements in a list.
- **Complete selection**
Press **Ctrl + A** within the list
- **Activation / Deactivation of list elements**
If list elements contain additional check boxes for activation/deactivation then multiple selection of those check boxes is achieved as follows:
 - Multiply select the desired list elements as described above
 - Press the **Space bar**. This toggles the selection of all the check boxes whose list elements have been selected.

4.4 Customizing BIS Configurator Outlook buttons

The standard settings show the Outlook buttons in the left column of the configuration browser, complete with icon and title.

There are two ways to fold these buttons into a compact form (miniature icons) and back:

- By mouse.
- By button



Fold/Unfold by mouse

Move the mouse to the upper edge of the Administration button until its cursor changes to a double-headed arrow. Then left-click and drag the edge downwards.



The visible buttons are removed one-by-one, and the last button compensates by displaying a miniature icon for each button removed.



Conversely, by pulling the edge upwards, the outlook buttons reappear and their miniature icons disappear.



Notice!

The currently active outlook button is marked only by a yellow background. Click other icons to activate other functions.

Fold/Unfold by button

Click on the button marked >> on the right hand side of the icon button.



Click **Show More Buttons** in the menu to replace a miniature icon with its Outlook button.

















Click **Show Fewer Buttons** in the menu to replace an Outlook button with its miniature icon.



4.5 Symbols used in the BIS Configuration Browser

The following symbols are used in the BIS Configuration Browser.

- | | | | |
|---|----------------|---|---------------------|
|  | Hardlock | | |
|  | Protocol print |  | Alarm print |
|  | Operators |  | Authorizations |
|  | Tree structure |  | Information |
|  | Event log |  | Detector placements |
|  | Divisions |  | Detector types |
|  | Time schedules |  | Server structure |
|  | States |  | Virtual devices |



Address lists



Associations



Device condition counters



Administration



Location



Logging / Protocol



Connections



Infrastructure



Accessories



Tools

5 General configuration concepts and activities

This section gives an overview of configuration concepts, prerequisites and structure. It also introduces those activities which are common to all BIS configurations.



Notice!

Avoid special characters

Use no special or non-Latin characters in BIS (e.g. Chinese, Russian, ä, é, ô, /, #, %, \$, |, !, ~, '). Use only non-diacritic (7-bit ASCII), alphanumeric characters [A-z] [0-9] plus underscore.

This applies to any characters typed into the BIS installation wizard or configuration browser, including passwords.

5.1 Overview of BIS configuration

BIS is a system which potentially integrates all the monitoring systems of its installation site. In order to do this the system must internalize a model of all the objects to be monitored and controlled. The creation of this model is the BIS configuration process. Any number of models, known as **configurations**, may be created, reflecting refinements or variants, but only one configuration can be loaded into BIS at a time. If a new configuration is loaded, then all operators are required to restart their clients, either immediately or after a set grace period.

- Configurations are stored as mnemonically named directory trees of files below the BIS server's main directory **MgtS**. For more details see *Structure and organization of the configurations, page 52*
- Configurations are edited largely using a tool known as the **Configuration Browser** (the only exception being those html files that are displayed in the BIS client application - these are typically edited in WYSIWYG html editors.)

The following illustration and table give an overview of configuration steps.

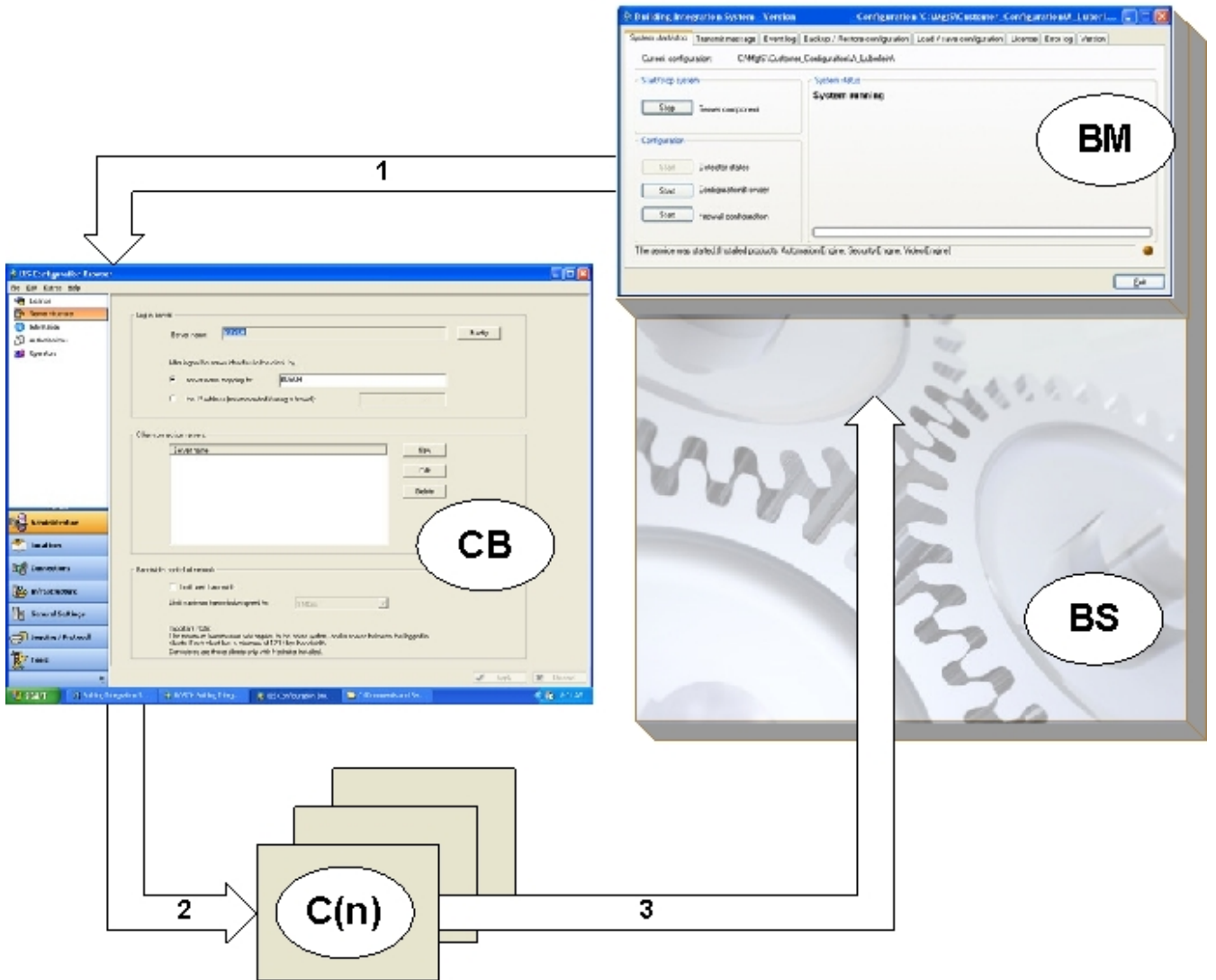

Figure 5.1: Overview of configuration steps

Object	Description
BM	The BIS Manager application - acts as a dashboard for the BIS server
CB	The Configuration Browser application - the editor for BIS configurations
BS	The BIS Server application, which runs the configuration in background processes, and which can be controlled through the BIS Manager.
C(1) to C(n)	The configurations residing in the file system of the BIS Server computer. Only one configuration is loaded at any one time.
Process	Description

Object	Description
1	The BIS Manager starts the Configuration Browser
2	The Configuration Browser creates and edits configurations
3	The BIS Manager controls the BIS server process: It loads a new, existing template or edited configuration and then starts the BIS server process with that configuration.

The following illustration and table show the main elements which make up a configuration. For clarity of overview it is not a complete list.

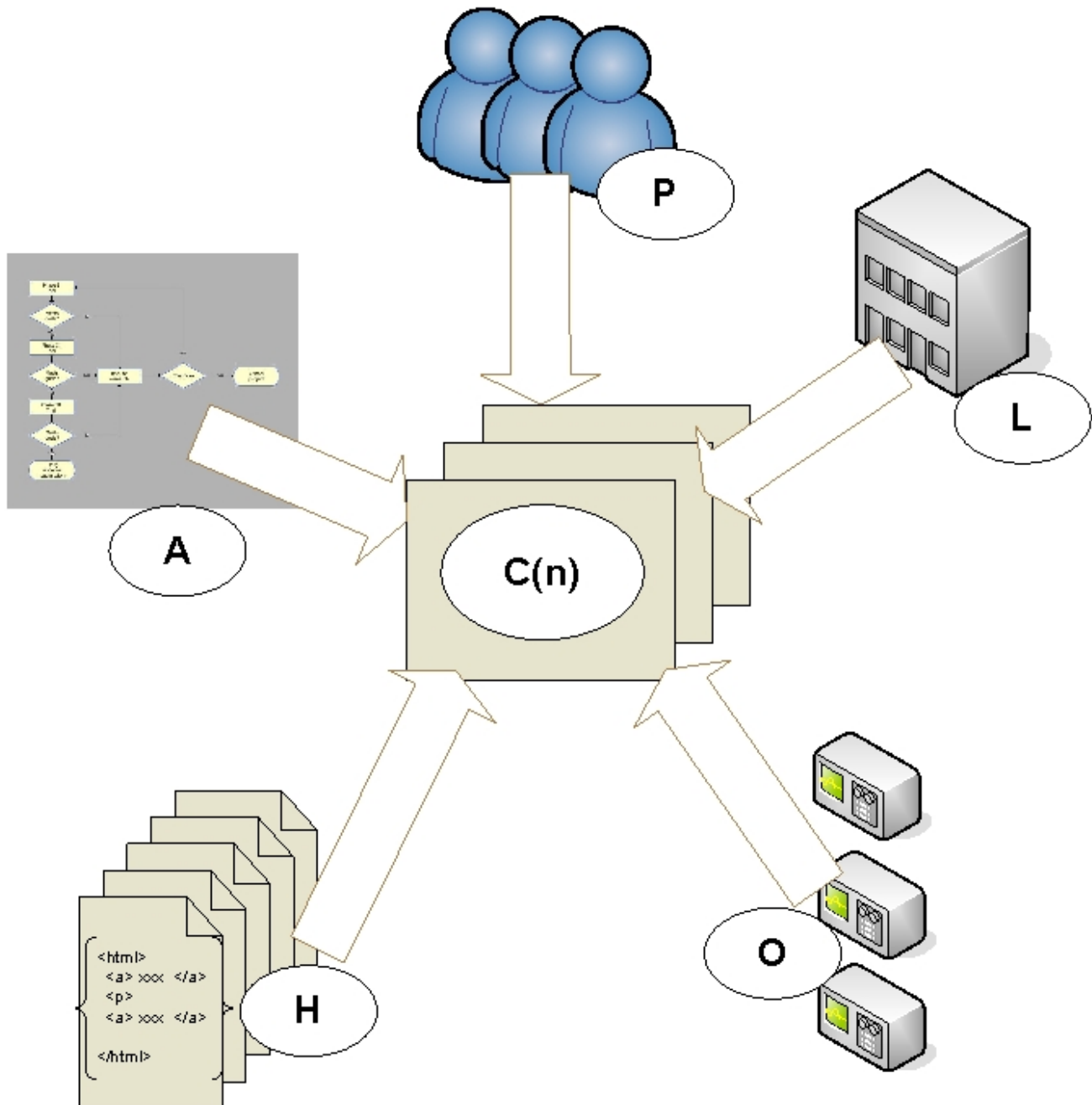

Figure 5.2: Elements of a typical configuration

Object	Description
C(1) to C(n)	The configurations residing in the file system of the BIS Server computer.
P	Persons , particularly operators defined within the system
L	Locations . The areas within the installation site
O	OPC devices
A	Associations : Rules that govern how changes in states should be handled
H	Html files which are displayed in the BIS Client user interface

5.2 Prerequisites of configuration

Before BIS can be configured it must be successfully installed as described in the **BIS Installation manual**. This means setting up the following, as described in that manual:

- The BIS software on the login server (either by first-time or upgrade installation).
- Licensing the software.
- (If used) DCOM and OPC Servers.
- The configuration of the internet browser for the BIS user interface, both on the BIS login server and on any client workstations.
- (If used) Optional BIS tools,

5.3 Licensing the BIS server

Licenses for BIS 4.0 and above are ordered online and delivered electronically. They function on two levels:

- You can purchase and activate licenses for a particular BIS server computer. See *Activating licenses for a BIS server.*, page 25 for details.
- You can import some or all of these licenses into each configuration that exists on that same BIS login server. See *Activating licenses for a configuration*, page 115 for details.

Activating licenses for a BIS server.

Prerequisites: You have purchased licenses for your BIS installation and received an email containing an authorization number.

1. Start the BIS Manager
2. On the **License** tab, click the **Start License Manager** button.
 - **Effect:** The License Manager dialog box is displayed.
3. Select the check boxes for the software package, the features, and the expansions that you have ordered. For the expansions, enter also the number of units required.
4. Click the **Activate...** button.
 - **Effect:** The **License Activation** dialog box is displayed containing your computer signature.
5. Write down the computer signature or copy and paste it into a text file.
6. On a computer with Internet access, enter the following URL into your browser:

<https://activation.boschsecurity.com>

 If you do not have an account to access the Bosch License Activation Center, either create a new account and log on (recommended), or click the link to activate a new

license without logging on. Note that for SMA (software maintenance agreement) licenses an account is always required. An account has the further advantage of keeping track of all your activations for future reference.

Follow the instructions on the website to obtain the License Activation Key.

7. Return to the software. In the **License Activation** dialog box, type or paste in the License Activation Key obtained from the Bosch License Activation Center and click the **Activate** button.
 - **Effect:** The software packages are activated for the computer.
8. Click the **Refresh** button to view the modified set of activated licenses



Notice!

Effects of hardware and software changes

Changes to the hardware of the BIS login server may invalidate your license and cause BIS to stop functioning. Please check with technical support before making changes to the BIS login server.

Import buttons

The button **Import Bundle Info** is not currently used in BIS.

The button **Import License** may be used in rare cases to import special license files, for example from technical support.

Demo Mode for developing and testing new configurations.

The BIS Configuration Browser, as opposed to the BIS application, can create and edit any configuration even beyond the scope of your license. Such configurations can be run and tested however only in **Demo Mode**. See *License, page 115* for more information on demo mode.

Demo Mode for Access Engine (ACE)

Note that, if installed, the BIS Access Engine (ACE) uses its own form of **Demo Mode**. This can be activated for ACE configurations in the Configuration Browser by clicking **Administration > ACE Licenses > button: Activate Demo Mode**.

5.4 Starting and stopping the BIS server

The BIS server software can be configured so that it is started automatically whenever the BIS server computer is booted.

(Click here for additional information: *The System Start/Stop tab, page 103*)

Otherwise the server must be started and stopped manually as described below:

Open the BIS Manager and perform the following steps on the **System start/-stop** tab:

Task and status information

Description

Click **“StartServer component”**
 Status LED: orange

During the startup process the BIS Manager displays by name the steps involved (1) and indicates overall progress with a progress bar (2)

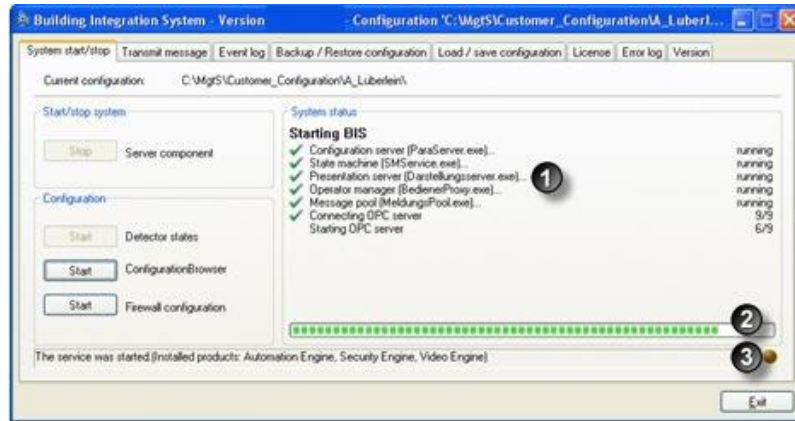

For as long the Status LED (3) glows orange the system is waiting for the execution of program components. Mouse over the LED to display the names of components not yet started. To the left of the LED BIS displays the names of the BIS products installed.

Display of the operators logged on.
 Status LED: green

If the startup process completes successfully then the Status LED (3) glows green and the BIS Manager switches to a tabular display of the operators logged on (4).

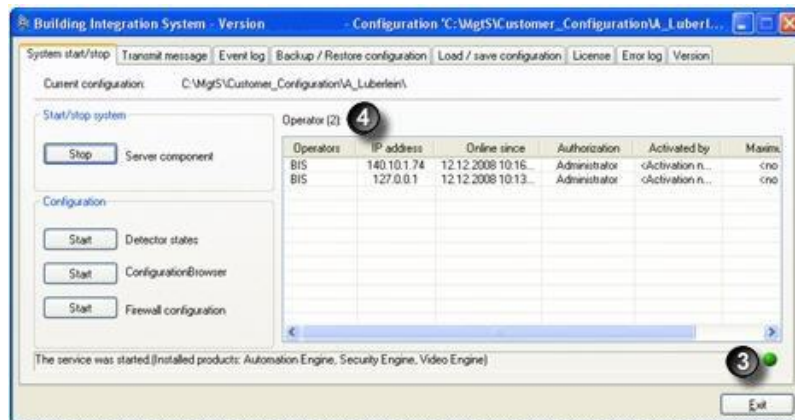

- The display contains the following information:
- Operator name
- IP address
- Online since
- Authorization
- Activated by
- Maximum bandwidth

“Stop” Server component

This is necessary, for example, to carry out a software update on the server.

During the shutdown process BIS displays the steps involved. To stop processing pending data from the OPC servers, and thereby speed up the shutdown process, click the X button (5).

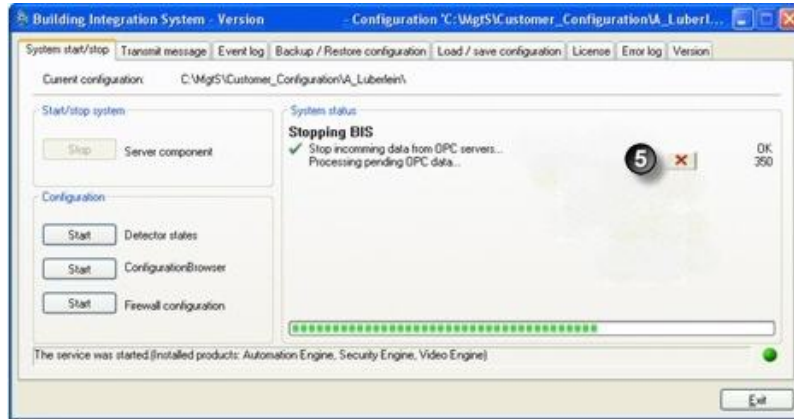

You will need to confirm this decision (6).

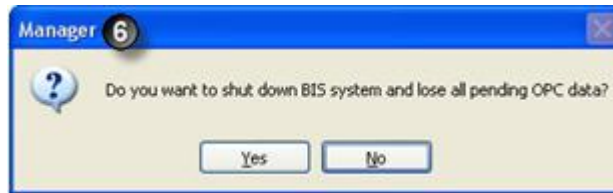

After confirming, the cancelled step will be marked with a red X (7).

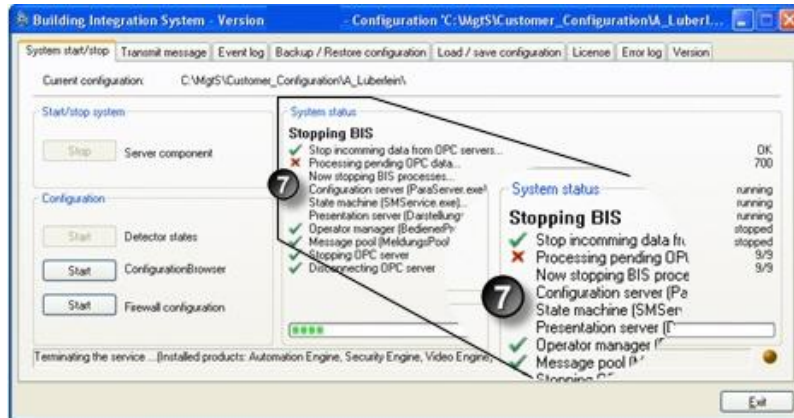

Stop the system server
Status LED: red

After a successfully shutting down the server, the Status LED (3) will be red and all steps carried out normally will be marked with a green tick (8).

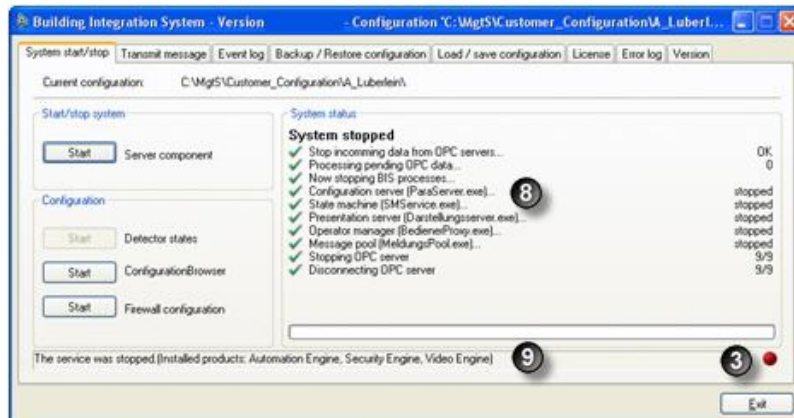

The message below the progress bar confirms that the services have been stopped, and continues to list the installed BIS products. (9).



Notice!

To inform logged-in operators of an impending shutdown of the BIS server, use **Transmit message** tab in the BIS Manager. Whenever the BIS server process is stopped all such operators will automatically be logged off.

5.5 Starting and stopping the BIS Configuration Browser

Perform the following procedure to start the BIS Configuration Browser:

1. From the BIS Manager's **System start/stop** tab, click the **Start** button next to the **Configuration Browser** label.

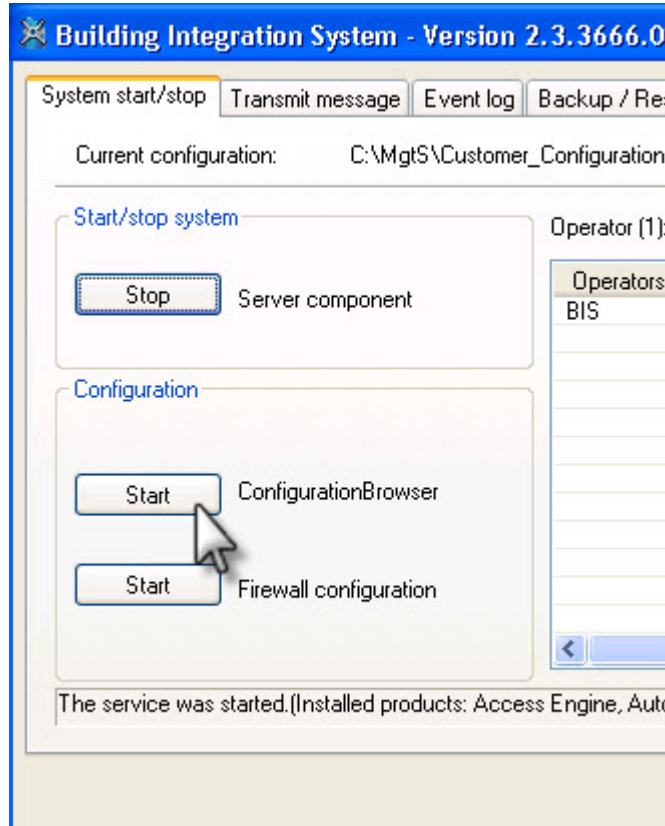

2. The initial Configuration Browser window appears.

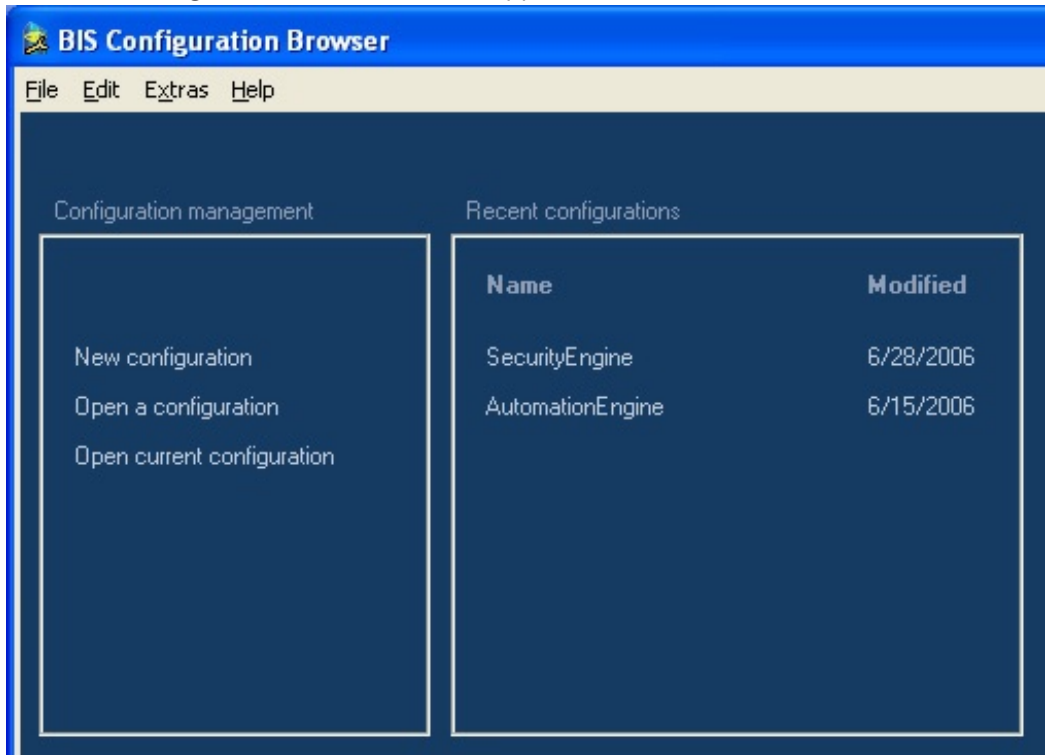

3. If your configuration already exists it can be selected here. Click the configuration name to start the Configuration Browser with that configuration. If you are configuring BIS for the first time, please continue with the next section *Setting up an initial BIS configuration*, page 30.
4. Once started, the Configuration Browser can be stopped in the Windows fashion by clicking **Menu: File > Exit** or the **Close** (“x”) button in the title bar.

**Notice!**

If you load a configuration created with an earlier version of BIS, you may be prompted to update the configuration file. This process will not change the configuration contents, only the file format.

5.6 Setting up an initial BIS configuration

Perform the following steps to set up a required initial configuration for the BIS server:

1. From the BIS Manager main screen, click **Start** Configuration program. The initial Configuration Browser window appears.

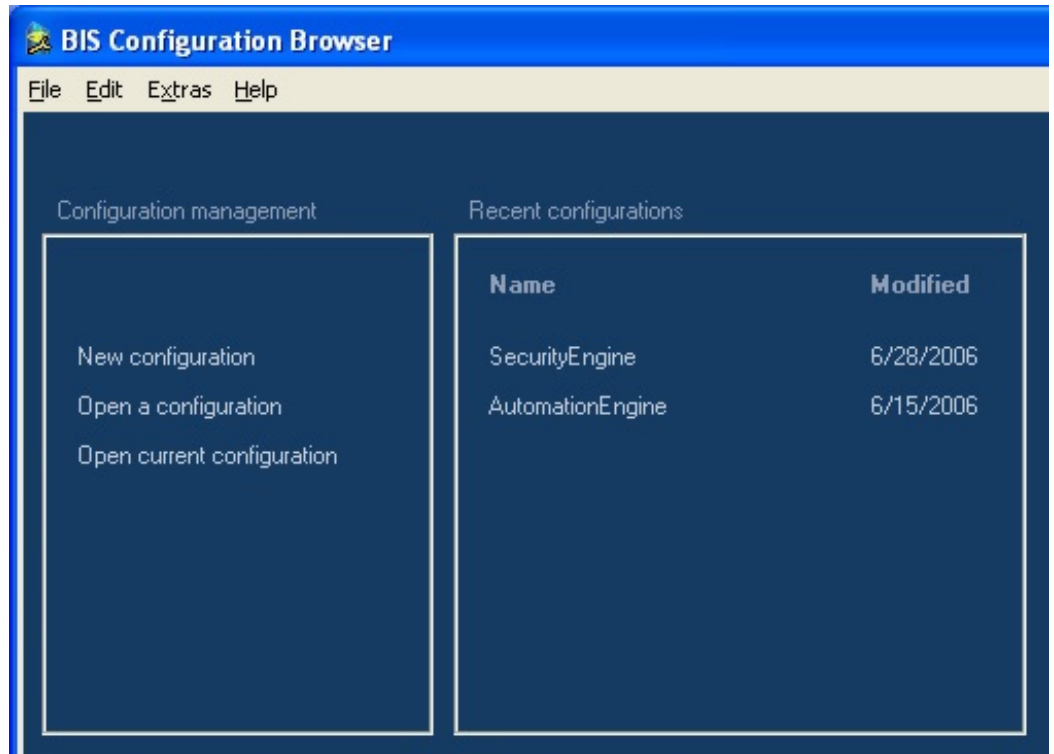

- Click **New configuration**, then select the template which meets your needs in the **Group** and **Name** fields. There are template configurations for each of the BIS engines. Click the **OK** button to create the new configuration based on that template.

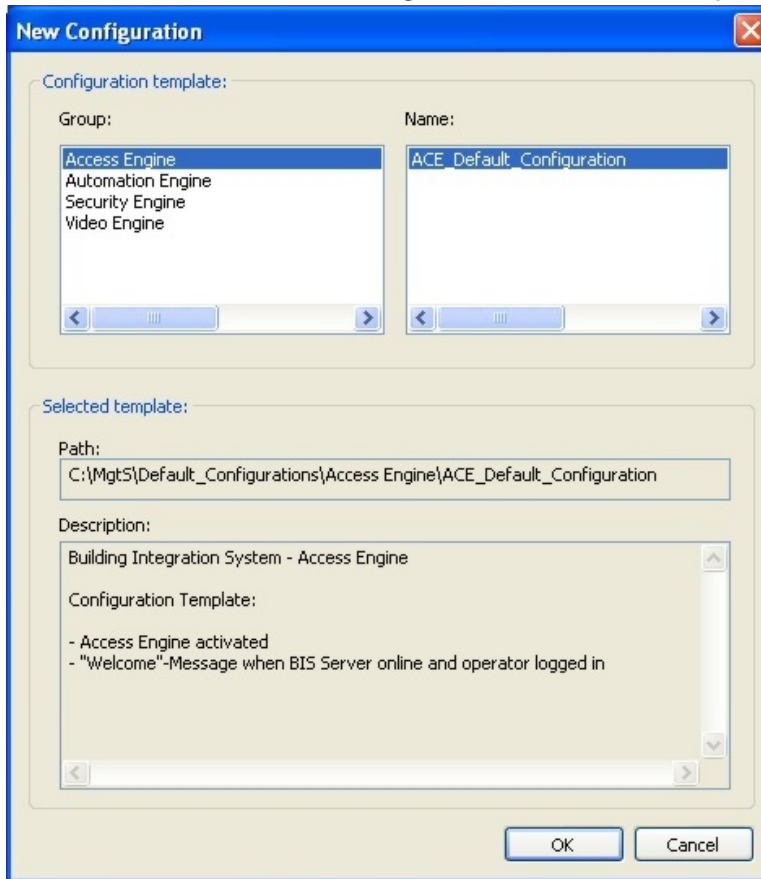

- Confirm the name of the directory where your configuration is to reside. The default is **C:\MgtS\Customer_Configuration**. Enter a mnemonic name for your configuration as the name of the folder where it will reside. Click **OK**.
- Enter the **Login name** and **Password**, then click **OK**.



Notice!

The default Operator name is **Administrator**, and the default Password is also **Administrator**. The login name is not case sensitive, but the password is. See *Operators*, page 124 for more information on Operators. See Change Password Tool for more information on changing passwords.

The Configuration Browser main window displays.

1. Click **Administration**, then select **Server structure**. The **Server structure screen** displays.

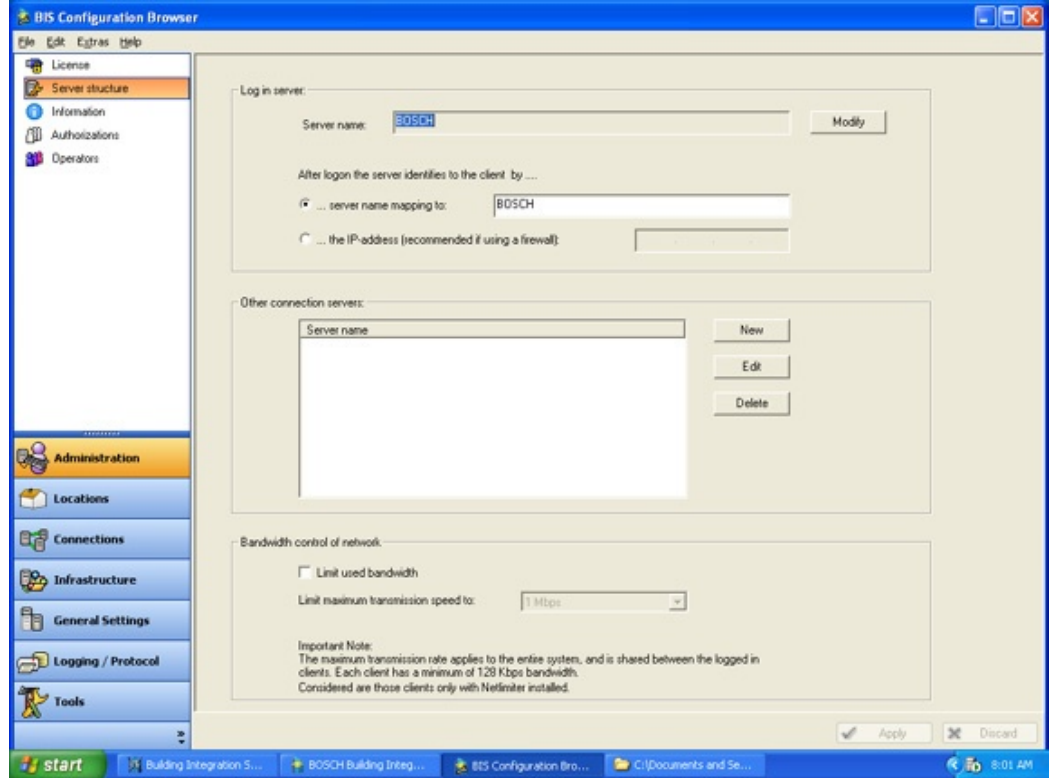

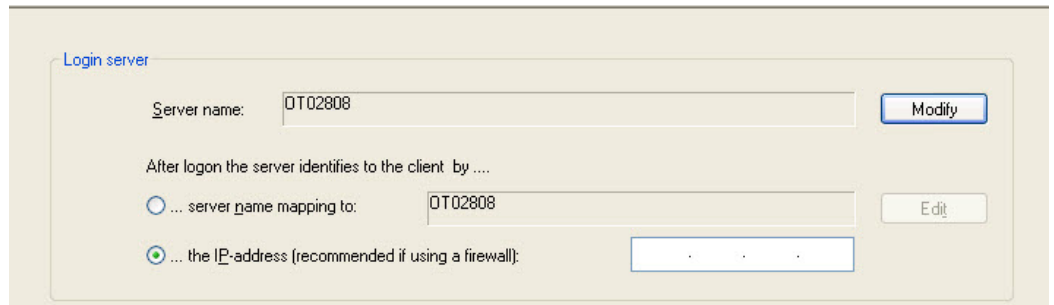

2. If the suggested name is not correct, click **Modify** and edit the **Server name** field so that it matches the server's net BIOS **Computer Name**.
3. If a firewall prevents network name resolution, enter the server's IP address, making sure the server has a static IP address (not DHCP). Otherwise leave the default selection **...server name mapping to:**

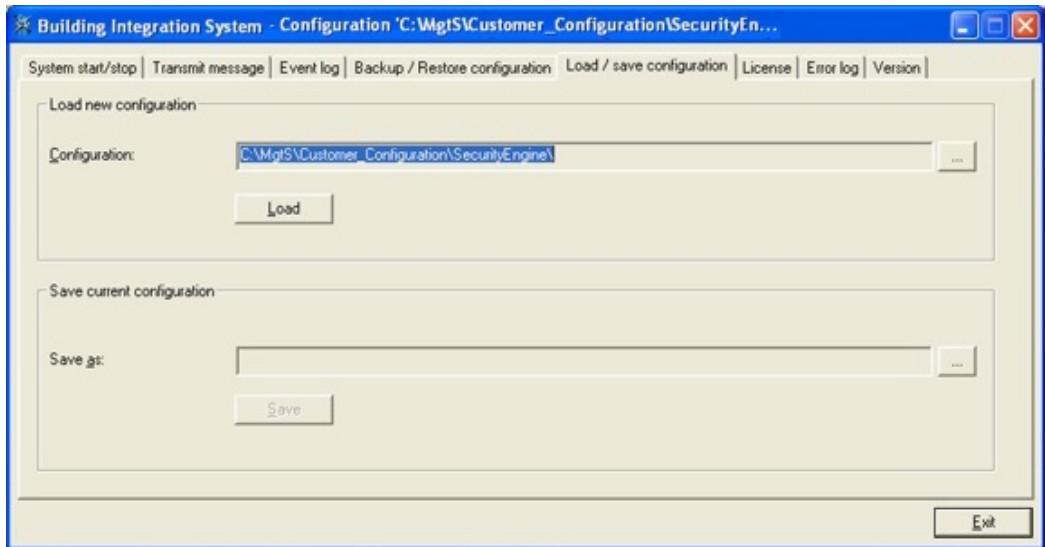

4. Click **Apply**.
5. Close the Configuration Browser window.

- In the BIS Manager window, select the **Load/save configuration** tab. It contains two panes: **Load new configuration** and **Save current configuration**.



- In the **Load new configuration** pane, click the ellipsis button  to browse.
- Select the directory containing the configuration to load, then click **OK**.

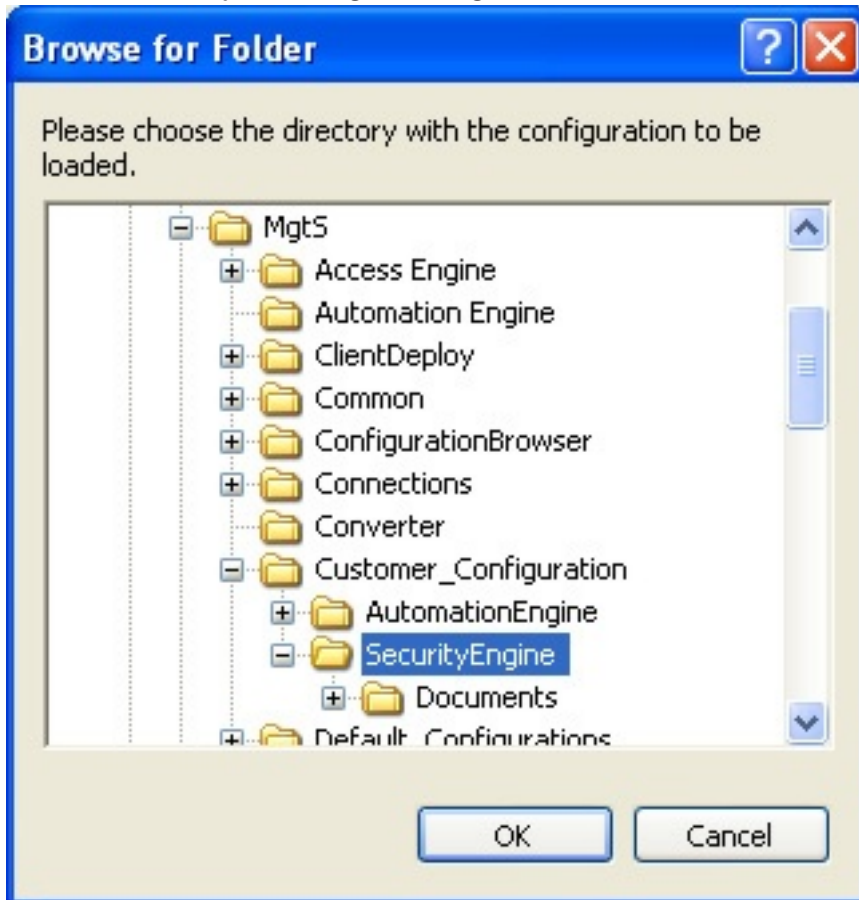

- In the **Load new configuration** pane, click the **Load**, button then confirm by clicking **Yes**.
- Click **Close**.
- From the **System start/stop** tab of the BIS Manager main screen you will see the server start. See *Starting and stopping the BIS server*, page 26 for more details.

You have now created and loaded a valid initial server configuration. However it does not yet contain any the functional elements of a working configuration.

5.7 Creating a new configuration

To create a new BIS configuration, follow the procedure outlined in *Setting up an initial BIS configuration*, page 30:

5.8 Opening (loading), saving and copying configurations

Opening a configuration

In the BIS Manager click the **Start** button next to the **Configuration Browser** label. A dialog appears in which you can create new or open existing configurations:

Loading a named configuration

From the BIS Manager's **Load/save configuration** tab, click the "...“ button and navigate to the desired configuration file, then click the **Load** button.

How BIS saves and loads configuration data

- Changes made to a configuration in the Configuration Browser are saved to the named directory of that configuration (under **<INST_DIR>\Customer_Configuration**) every time you change from one main menu to another.
- Whenever you click the **Start** or **Load** button in the BIS Manager BIS compares the named configuration it last used with the configuration in **<INST_DIR>\Runtime_Config**. It then copies any modified files to **<INST_DIR>\Runtime_Config** and then loads that configuration.
- To run a different named configuration from the one loaded last time, click BIS Manager tab: **Load/save configuration** , enter or browse the location of the desired configuration in the **Configuration** text field and click button: **Load**.
- To save the current configuration for later use or modification, click BIS Manager tab: **Load/save configuration** , enter or browse the desired location in the **Save as** text field and click button: **Save**.



Notice!

Saving configuration data from non-Bosch OPC servers and remote computers
Configuration data of non-Bosch OPC servers and connection servers on other computers must be backed up separately when saving the configuration.

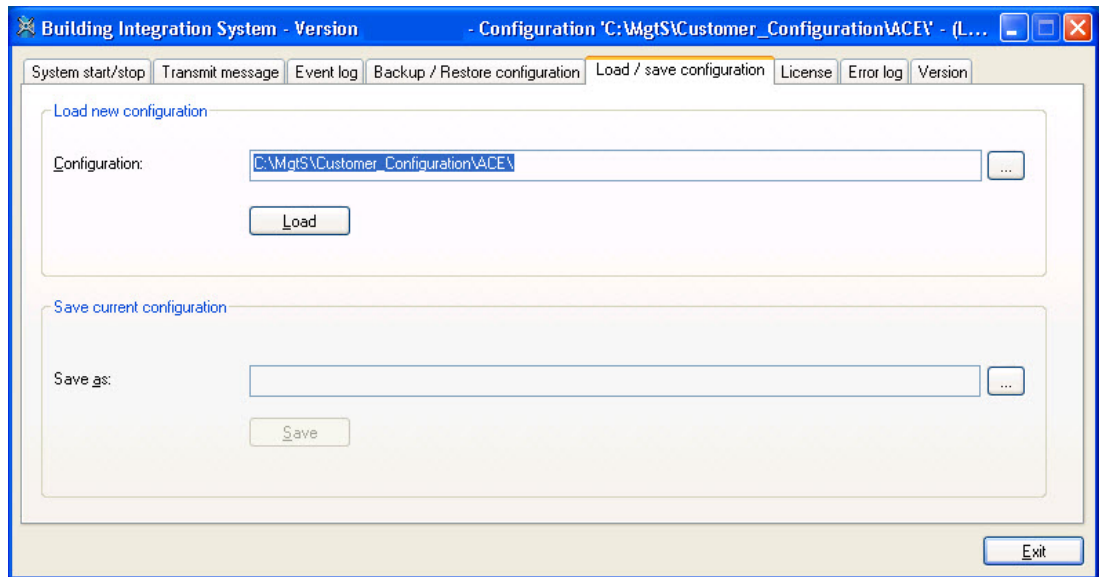

Reloading a modified running configuration

If the running configuration is changed by an administrator it must be reloaded for the changes to take effect. There are two options:

- Reload the configuration with immediate effect, disconnecting all operators at once.
- Reload the configuration with delayed effect (10 minutes by default). This allows the operators a grace period in which to finish what they are doing and restart their clients manually.

Note: a major benefit of this option is that, in the case of two or more operators, at least one operator may be logged on at all times. That is, there is no longer any time in which the BIS Messages are not being monitored.

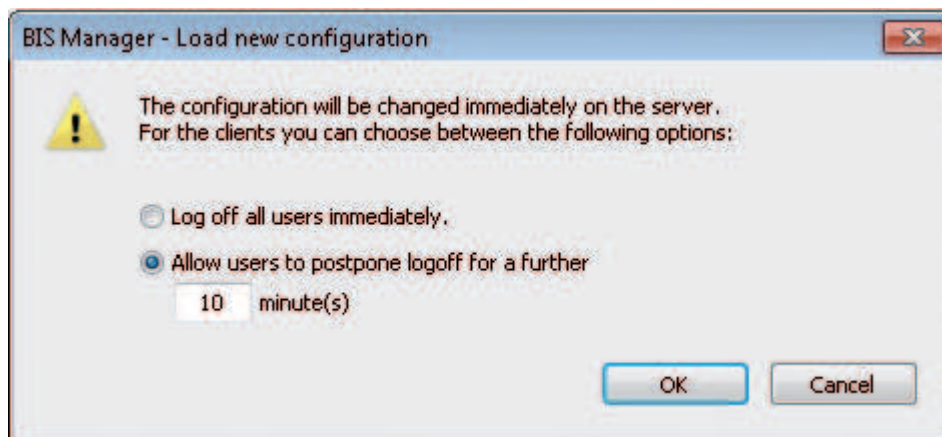

Figure 5.3:

Reloading a modified configuration with immediate effect

This option is recommended where it is not imperative that at least one operator be logged on to BIS at all times. It is also recommended whenever changes have been made to operator authorizations.

Prerequisite: You are on the BIS Manager tab: **Load/save configuration**

1. Click button: **Load**

- Result:** The **Load new configuration** dialog appears
- 2. Select the radio button **Log off all users immediately**
- 3. Click button: **OK**
- ✓ **Result:** The configuration is reloaded immediately, the clients are restarted and their operators left at the BIS login prompt.

Reloading a modified configuration with delayed effect

This option is recommended where it is imperative that at least one operator be logged on to BIS at all times. However if changes have been made to operator authorizations then an immediate logoff is recommended instead.

Prerequisite: You are on the BIS Manager tab: **Load/save configuration**

- 1. Click button: **Load**
Result: The **Load new configuration** dialog appears
- 2. Select the radio button **Allow users to postpone logoff for a further ___ minute(s)**.
- 3. Set a new value for the number of minutes, or leave the default in the text box.
- 4. Click button: **OK**
- ✓ **Result:** All operators on connected clients are shown a dialog box inviting them to restart their clients as soon as possible, but displaying a timer counting down from number of minutes set above. When the timer reaches zero the configuration is reloaded immediately, the clients are restarted and their operators automatically logged on again.

Availability of some configuration changes during the grace period

Purpose of the grace period is to ensure that a configuration change does not incapacitate all operators simultaneously, even for a short time. Operators can stagger their restarts to ensure that at least one is monitoring the system at all times.

To ensure the greatest possible system integrity the client restart should be performed as soon as possible after notification, and no mission-critical operations should be performed during the grace period.

Nevertheless the following table lists the main configuration additions, modifications and deletions that will be available to operators during the grace period, under the restrictions there described.

Changed object	Add	Modify	Delete
BIS operator	Visible in the client after clicking the Refresh button or folding/unfolding the relevant part of the device tree.	Property "Allowed to terminate client" is propagated to the client on the fly. All other properties visible in the client after clicking the Refresh button or folding/unfolding the relevant part of the device tree. If modified in the configuration the operator is	If deleted from the configuration the operator is immediately logged off the client.

Changed object	Add	Modify	Delete
		immediately logged off without reloading the configuration.	
Device / Groups / Detectors and other BIS addresses	Visible in the client after clicking the Refresh button or folding/unfolding the relevant part of the device tree.	Changes of address are visible in the client after clicking the Refresh button or folding/unfolding the relevant part of the device tree. A client restart is required to display changed names reliably.	A client restart is required to remove deleted devices from the GUI. Until restart the deleted objects are marked with a # character.
Address lists	Visible in the client after clicking the Refresh button or folding/unfolding the relevant part of the device tree.	Changes of address are available. Note: Change of address list name requires client restart	Until restart the deleted objects are marked with a # character.
Graphic files / Named views / Layers	Detector mappings available. State changes are highlighted with the colors of the new states.	Not available. The old graphic file and layer information are not updated until after client restart	Not available. The old graphic file and layer information are not updated until after client restart
Action plan and Misc. documents	Newly created links to Action Plans and Misc. Documents are available.	If an Action Plan or Misc. Document is in use when its link is changed or deleted, then the old document persists until the operator has finished in it. The newly linked document will not appear until the next invocation.	If an Action Plan or Misc. Document is in use when its link is changed or deleted, then the old document persists until the operator has finished in it. A document that has been unlinked will not appear again.
Timer settings NB: <i>General settings >Timer (not the timer within jobs)</i>	Available	Available	Available

Changed object	Add	Modify	Delete
Counters and groups	Not available	Changes in participating address lists and state lists available. Changes in name and/or color require restart.	Counter remains visible but ceases to count
Associations (Jobs)	Available	Available	Available
BIS operator authorizations	(not directly visible in the client)	The following modifications available: <ul style="list-style-type: none"> – The property "Allowed to terminate client" – Modifications to addresses and address lists 	Authorization can only be deleted if no operator has it.
ACE user profiles	Available	Available	Available
ACE workstation profiles	Available	Available	Available
ACE areas	Available upon Refresh	Available upon Refresh	Available upon Refresh
ACE reader types, card configurations, PIN code configurations	Available	Available	Available
ACE divisions	Requires client restart	Requires client restart	Requires client restart
Index page	Requires client restart	Requires client restart	Requires client restart
Virtual devices	Available	Requires client restart	Requires client restart
Alarm print	Print template, state mapping, printer and layer information is updated for automatic alarm printing. All other features require client restart	Print template, state mapping, printer and layer information is updated for automatic alarm printing. Modified layer information is not available for manual printing.	Print template, state mapping, printer and layer information is updated for automatic alarm printing. All other features require client restart
Event log	Available	Available	Available

Changed object	Add	Modify	Delete
OPC and connection servers	Available upon Refresh	Requires client restart	Requires client restart

Copying a configuration

When you save a configuration under a new name (in the configuration client, select **Load/save configuration**, then click **Save As...**), all configuration files are saved in a new directory. This allows you to create variants of a configuration without changing the original configuration.

Saving your configuration work



Notice!

Recommended practice

All modifications made in the Configuration Browser are saved when you select the **Load/save configuration** tab, then click **Save**.

Remember to save your configuration work periodically.

5.9

Configuration printouts

To print a summary of the entire configuration click menu: **File > Print** in the Configuration Browser.

5.10

System operators

Introduction

There are two kinds of system operators:

- **System-defined** operators such as BIS, Administrator.
- **User-defined** operators,
 - whereby user-defined operators can be either:
 - BIS operators defined only within BIS
 - or
 - BIS operators based on Active Directory users.

The following sections describe how to set up both kinds of user-defined operators in the system.

Special predefined authorizations

All user-defined operators require an **Authorization**, which is a set of permissions to access, to control and to modify parts of the system.

- The authorization **No authorization** is automatically assigned to every newly created operator. This means that all operators are initially disabled by default. You must always assign a different authorization manually to enable the new operator to log on to the system.
- The authorization **Administrator**, which has all permissions, always exists, and can be used initially to set up any operator. For security reasons Bosch urgently recommends that you create and assign a less powerful authorization to new operators.

Note that the predefined authorization **Operator ACE** only exists if Access Engine is installed and licensed.

Prerequisites**Authorizations**

If the new operator is to have less than total Administrator control of the system, then create a restricted authorization for them.

For instructions on creating a new customized authorization see section *Authorizations*, page 118

Profiles

The new operator will also require a **User profile**, which determines the layout and screen resolution of their BIS logon screen.

For instructions on creating a new customized User profile see section *Operators*, page 124

Workstations

Security-critical operator tasks will need to be performed on workstations in secure areas.

Less critical tasks may be performed, for example, on workstations at the reception desk.

BIS provides different ways of mapping operators' authorizations to workstations:

- **Apply to all workstations:** An operator's authorization can be used at all workstations without restriction.
- **IP-filtered:** An operator's authorization can only be performed at a workstation with a particular IP address, or at an address within a specified subnet.
Note only IP version 4 is currently supported.
- **Workstation specific:** An operator's authorization can be assigned to one or more workstations selected from the list of all configured workstations.

For instructions on the different mappings, see the following sections.

**Notice!**

Operator names are limited to **50 characters**.



The following characters are not allowed: # < > ' " & * ? .

The password is case sensitive but the name itself is not.

See also

- *Authorizations*, page 118

5.10.1**Operators with authorizations on all or on IP-filtered workstations****Procedure**

1. In the Configuration Browser, navigate to **Administration > Operators**
The main **Operators** dialog appears
2. Click the  icon to add a new Operator to the list, or  to edit an existing Operator.
Adhere to naming restrictions above.
3. From the list labeled **Authorization:** select a suitable authorization for the operator. See **Prerequisites** above.
4. From the list labeled **Use profile:** select a suitable operator profile. See **Prerequisites** above.
5. Ensure that the check box **Apply to all workstations** is selected (default)
6. (Optional) If the new operator is to work only from a particular workstation, enter the IP address of the workstation in the text box **IP address**.
7. (Optional) If the new operator is to work only from a particular subnet, enter an IP filter additionally in the text box **IP filter**. For instructions on creating an IP filter see *Operators*, page 124
8. Click **Apply** to save the changes.

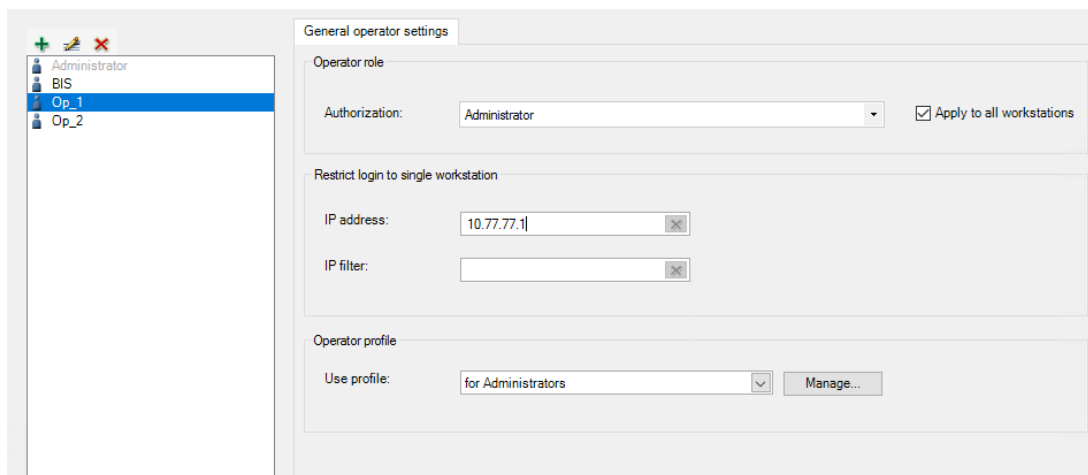

See also

- *Operators, page 124*



5.10.2

Operators with authorizations on selected workstations

Prerequisites

You are logged on to the BIS configuration browser as a normal BIS operator, not as an Active Directory user.

Procedure

1. In the Configuration Browser, navigate to **Administration > Operators**
The main **Operators** dialog appears
2. Click the  icon to add a new Operator to the list, or  to edit an existing Operator. Adhere to naming restrictions above.
3. From the list labeled **Authorization:** select a suitable Authorization for the operator. See **Prerequisites** above.
4. From the list labeled **Use profile:** select a suitable operator profile. See **Prerequisites** above.
5. Ensure that the check box **Apply to all workstations** is cleared.
 - The **Workstation specific authorization** pane appears with 2 columns: **Workstation** and **Authorization**.
 - All the workstations that are defined within the current configuration are listed in the pane.
 - If an authorization was already in the **Authorization** pull-down list when you cleared the **Apply to all workstations** check box, then that authorization is copied to the **Authorization** column for all workstations.
6. To set an authorization for a particular workstation, click in the **Authorization** column and select one of the defined authorizations from the cell's pull-down list. Repeat this step for all workstations in the list.
7. Alternatively, to copy the same assignment to all the other workstations listed, click the  button at the end of the row.
8. Click the **Apply** button to save the changes.

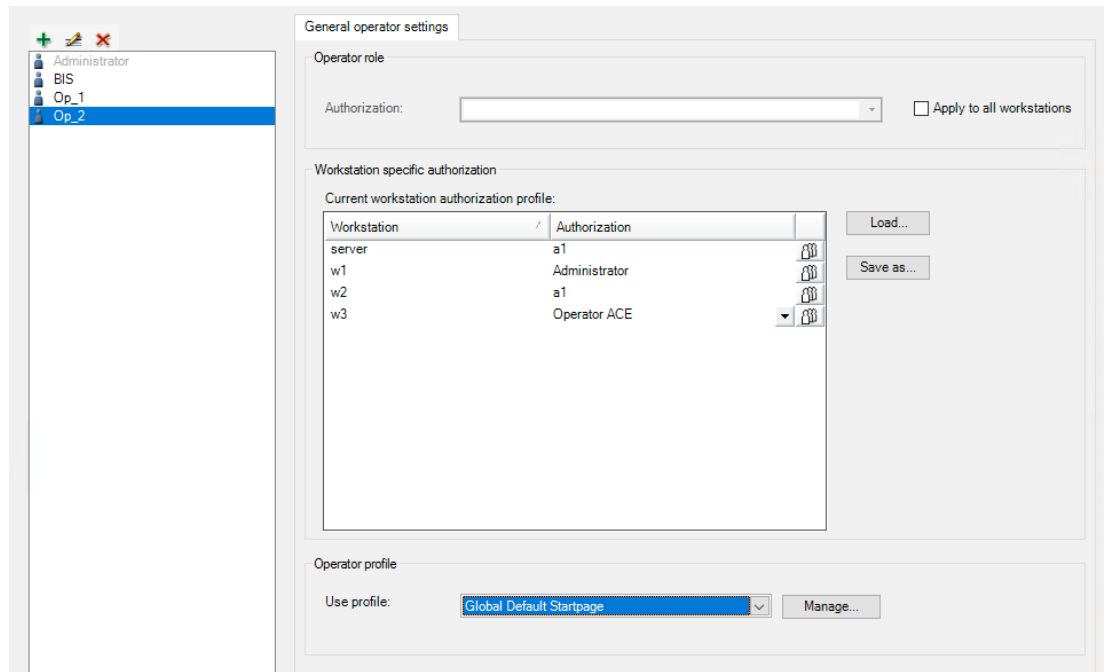

Additional remarks on mapping authorizations to selected workstations

This method of mapping is completely explicit, without exceptions. It follows that: Operators whose authorizations are workstation specific can only log on to workstations that are explicitly defined, and for which they have a non-void authorization (i.e. not **No authorization**).

Hence, if such operators need to log on to the BIS server, then the BIS server must be explicitly defined as a workstation in the configuration.

Saving and reloading authorization / workstation mappings.

- Click **Save as...** to save the current authorization / workstation mapping to the BIS configuration. Give it a mnemonic name.
- Click **Load...** to load a saved mapping by name, and so apply it to a different operator if desired.

Conflict resolution where workstations are multiply defined

The same workstation may be defined twice in the list, namely by:

1. IP address
2. Hostname

The BIS server itself may be defined as many as 4 times, namely by:

1. Local IP address (127.0.0.1)
2. localhost
3. IP address
4. Hostname

In such cases, when searching for an authorization for an operator, the system searches the workstation definitions in the order 1..2 or 1..4 as stated above, and assigns the authorization that is mapped to the first workstation definition that it finds.

Passwords for operators that are set up in BIS

When a new operator is set up its password is the same as the operator name.

The operators themselves can change their passwords when logging on to the BIS client. For security reasons it is important to change the default password as soon as possible.

An operator with sufficient authorization can set or reset an operator password in the Configuration Browser.

1. In the Configuration Browser main window menu, click: **Extras > Change password...**
2. Enter the operator user name, old password, new password (twice).

5.10.3

Setting up an Active Directory user as an operator

Prerequisites

An Active Directory server is available on your network, and the usernames of potential operators are registered on it.

Procedure

1. In the Configuration Browser, navigate to **Administration > Active Directory config**
2. Next to the text field **Server Information:** click the **Modify...** button
The dialog **Active Directory server information** appears
3. Enter values for the following parameters:
 - **Server name:** The name or IP address of the active directory server on your network
 - **Protocol:** Use the default `LDAP`
 - **Port:** Use the default `389`
 - **Proxy user name:** The username of an account with administrator privileges on the Active Directory server
 - **Proxy user password:** the password for that account.
4. Click the button **Test connection** to test the connection to the Active Directory server
Ensure that the connectivity is confirmed on the button before proceeding. In the case of failure, revise the server information in the dialog.
5. Click the **OK** button
The dialog **Active Directory server information** closes
6. Back on the main dialog **Active Directory config** click the **Modify filter groups...** button
The dialog **Active Directory group filter** appears
7. Click the button **List groups**
The Active Directory groups are listed in the list window.
8. Click **OK**
The dialog **Active Directory group filter** closes
9. Back on the main dialog **Active Directory config** click the list **Active Directory groups** and select an Active Directory group from which to add a BIS operator.
10. Click the list **BIS authorization** and select a BIS Authorization to be associated with that Active Directory group
11. Click the list **BIS user profile** and select a BIS user profile to be associated with the Active Directory group and BIS authorization
12. Click the **Add** button
A mapping between an Active Directory group and the BIS Authorization appears in the list labeled **Existing mappings:**
13. Repeat the steps 6 to 12 above to create more mappings.
14. To delete or change the order of mappings in the list, select lines in the list and use the buttons (move up, move down, delete) next to the list.

**Notice!**

Note that when assigning an Active Directory user to a BIS Authorization, the system reads this list **from top to bottom**, and assigns the BIS Authorization that is mapped to the **first** Active Directory group to which that user belongs.

Communicating Active Directory changes to BIS

If Active Directory groups are subsequently renamed or deleted you must communicate these changes to BIS. Proceed as follows:

1. In the Configuration Browser, navigate to **Administration > Active Directory config**
2. Click the **Sync groups** button
3. Respond with **OK** to any ensuing warnings about deletions or renamings.
The changes will be reflected in the **Existing mappings** list.

**Notice!**

Active Directory users whose groups are no longer mapped to BIS Authorizations will no longer be able to log into BIS.

Instructing an Active Directory user to log on to the system

When you have created a mapping between an Active Directory group and a BIS Authorization, any member of that group can log on to BIS, and work with that BIS Authorization. Instruct the new user as per the following example.

If the Active Directory domain is called `MYDOMAIN` and the username `Miller` then the user logs on to the system with:

- Username: `MYDOMAIN\Miller` (note the backslash between domain and username)
- Password: <Active Directory domain password for `MYDOMAIN\Miller`>

5.11

OPC classic connections

Introduction

OPC servers are the means by which BIS interacts with the outside world. As a BIS configurator you should already have a good understanding of OPC technology. BIS works with different kinds of OPC server:

- AE (Access Event): Green icons.
- DA (Data Access): Blue icons.
- AEDA (Combined Access Event / Data Access): Pink icons.
- UA (Unified Architecture). BIS 4.6 and later. See specialized chapter *OPC UA connections, page 48*

Adding a classic OPC connection

To add a new OPC classic connection, follow the procedure described in *Creating connections and addresses by browsing, page 136*.

DA Groups

DA servers (DA or AEDA types) must have at least one Group. DA Groups can be edited in the lower right pane when the respective root node is selected in the BIS-address tree (upper right pane).

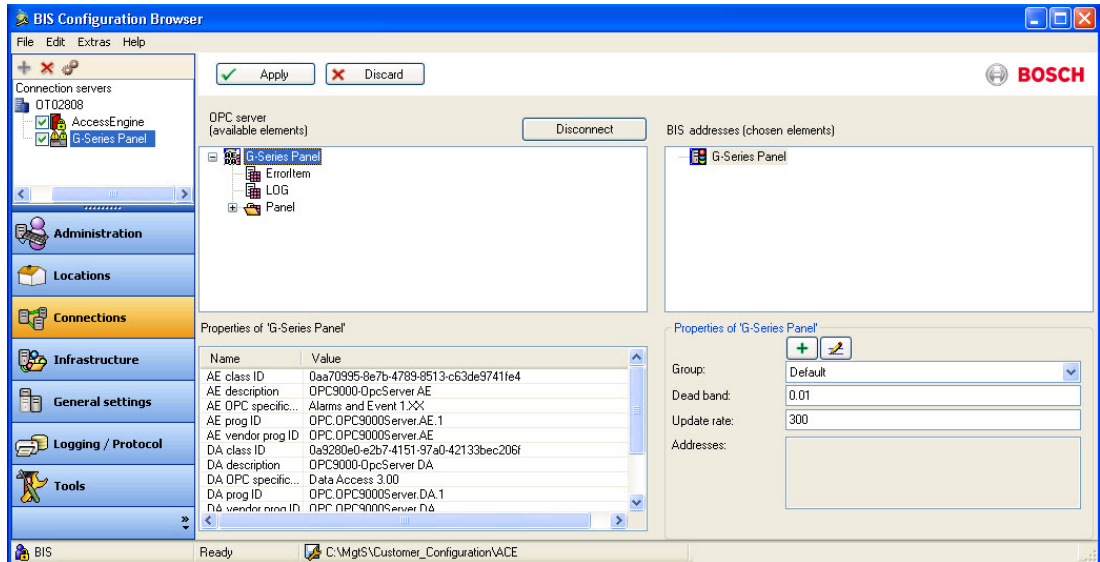

- The Default group always exists
 - Add a new group with the + button
 - Selected DA items can be assigned to any existing DA Group
 - When a group is deleted, all items in this group become members of the Default group
 - The text box shows all addresses assigned to a DA Group
- (For more information on Update Rate and Dead Band, refer to the OPC DA specification.)

Detector Types for non Common Requirements OPC server

Every BIS address must receive a detector type. “Common Requirements” detectors receive their detector types from the OPC server at run-time.



For other OPC servers, the detector types are defined according to the following rules:















- AE or combination (AEDA) server: the detector type becomes “**R_Event**”
- DA: The detector type has the form **<AccessRights>_<OPC-Type>** where
 - **<AccessRights>** can be on of: **R** (Readable), **W** (Writable), **RW** (Readable and Writable), or **XX** (unknown)
 - **<OPC-Type>** is the OPC item type

Detector types listed according to their respective BIS engines.

The following table lists the common detector types according to the BIS engines where they may be used. The abbreviations for the BIS engines are as follows:

- ACE - Access Engine
- AUE - Automation Engine
- SEE - Security Engine
- VIE - Video Engine

Icon	Name	Engine
	Access Engine	ACE
	Allegiant Matrix	AUE, VIE

	AMC2-IO-NET	AUE
	Application Launcher	ACE, AUE, SEE, VIE
	Beckhoff (serial)	AUE
	D6600 Receiver	AUE, SEE
	Dibos DVR	VIE
	Divar DVR	VIE
	FAT	AUE, SEE
	G-Series Panels	SEE
	Generic OPC server (Third party)	AUE
	LSN / Trend DA	AUE
	OPC Adapter	AUE
	Praesidio PA	AUE
	Printer SNMP	ACE, AUE, SEE, VIE
	PS-MANSYS / Alphadesk	AUE
	VDS	AUE
	VideoJet IP Video (VCS)	VIE

5.12 OPC UA connections

Purpose

This module describes how to add an OPC UA server to your BIS configuration, and browse the items that you wish to monitor in BIS.

Introduction

Definition: OPC Unified Architecture (OPC UA) is an enhanced OPC protocol from the OPC Foundation. It provides better platform independence, scalability and data security than its predecessors.

Products concerned

Building Integration System (BIS) 4.6 and later

Intended audience

System administrator

Context

Configuration

5.12.1 Adding an OPC UA server using the Local Discovery Server

Prerequisites

- BIS has been successfully installed.
- Your BIS system has access to at least one OPC-UA server on the network.
- The Windows service OPC UA Local Discovery Server is running on your BIS login server.

If the Local Discovery Server is not running then start the service in the Windows **Services** application, or proceed to the section *Adding an OPC UA server manually (without the Local Discovery Server)*, page 48

Procedure

1. In the BIS Configuration Browser navigate to **Connections > Connection servers**
2. Right-click the connection server that is to connect to the OPC UA server and select **Add subsystem...**
The **Select new subsystem** dialog opens.
3. From the list labeled **Configurable OPC Servers** click **OPC UA Servers > Generic OPC UA Server**
The main pane of the dialog is populated with controls.
4. Ensure that the Local Discovery Server is running (see Prerequisites above): the light bulb icon labeled **Local Discovery Server** must be appear lit (yellow) and the subsystems that it has detected are displayed in a list in the center of the dialog.
Selecting any server from the list will display its subsystem name, subsystem type and URL in their respective text fields.
5. Select the desired OPC UA server and click the **OK** button.
The selected subsystem is added below the connection server that you selected above.

See also

- *Adding an OPC UA server manually (without the Local Discovery Server)*, page 48

5.12.2 Adding an OPC UA server manually (without the Local Discovery Server)

Prerequisites

- BIS has been successfully installed.

- Your BIS system has access to at least one OPC-UA server on the network.

Procedure

1. In the BIS Configuration Browser navigate to **Connections > Connection servers**
2. Right-click the connection server that is to connect to the OPC UA server and select **Add subsystem...**
The **Select new subsystem** dialog opens.
3. From the list labeled **Configurable OPC Servers** click **OPC UA Servers > Generic OPC UA Server**
The main pane of the dialog is populated with controls.
4. In the text box labeled **Server url:** Enter the URL of the OPC UA server, without the security mode and security policy, for example `opc.tcp://<nodename>:<portnumber>`
5. Click the **Validate and Add** button, with its check mark, to the right of the text box.
If the URL is valid, the corresponding OPC UA server will be displayed in the list in the center of the dialog. Select that server in the list to display its subsystem name, subsystem type and URL in their respective text fields.
6. Select the desired OPC UA server and click **OK**.
The selected subsystem is added below the connection server that you selected above.

5.12.3

Browsing OPC UA items into the BIS configuration

Introduction

When an OPC UA server has been added you need to specify which of its items should be included in the BIS configuration for monitoring in the BIS application.
The enhanced security options offered by OPC UA need to be configured before the individual items can be browsed. Unlike classic OPC servers, with OPC UA it is not possible to browse the items by clicking the **Connect** button immediately.

Certificates

Certificates are an important means of authentication between the OPC UA client (BIS) and the OPC UA server.
The certificates that are automatically created by BIS are stored on the installation drive under `\MgtS\pki\own\certs\`. Copy these certificates manually to the standard location for certificates on the OPC UA server, for example `<OPC UA server certificate folder>\pki\trusted\certs\`
BIS will prompt for OPC UA server certificates while validating or connecting. If BIS accepts a certificate then it will be stored under `MgtS\pki\trusted\certs\`



Notice!

No automatic backup of certificates
BIS's own certificates, and the certificates it has accepted, are not backed up automatically. Back them up manually in order to restore and reuse the configuration.

Procedure

1. In the BIS Configuration Browser navigate to **Connections > Connection servers**
2. Right-click the OPC UA subsystem that you wish to browse and select **Properties...**
The **Subsystem properties** dialog opens

3. In the **Endpoint selection** drop-down list, select one of the options, depending on your security requirements and the capabilities of the OPC UA server itself.
Depending on the Endpoint selection, the fields **Endpoint URL**, **Security Mode**, **Security Policy** and **Message Encoding** will be populated.

Endpoint	Security mode	Security policy	Message encoding	Notes
opc.tcp SignAndEncrypt Basic128RSA15 uatcp-uasc- uabinary	Sign And Encrypt	Basic 128RSA15	Binary	opc.tcp is the preferred option for performance. All messages are transferred in binary format via TCP protocol. Sign and encrypt is the preferred option for security. All the messages are signed and encrypted using security policy Basic128RSA15
opc.tcp Sign - Basic 256 uatcp-uasc- uabinary	Sign	Basic Sha256	Binary	All messages are signed but not encrypted, The security policy is Basic256.
opc.tcp None- None uatcp-uasc- uabinary	None	None	Binary	No additional security is applied to the messages transferred.
https None None https uabinary	None	None	Binary	If using https, ensure that the TLS encryption used is the same at both endpoints. See Internet Explorer > Settings > Internet options > Advanced tab > Security
				Note that HTTP is deprecated by the OPC UA foundation and is not supported by BIS.

4. In the **Authentication Settings** pane > **User identity** drop-down list, select one of the following options:
- **Anonymous** - The client has no user name or password
 - **User Name** and **Password** (on the computer where the OPC UA server is running).
 - **Certificate** - a **Browse** button appears to enable you to pick a certificate file from your filesystem, and a text box in which to enter the certificate's password.
5. To verify that the credentials are correct before saving the subsystem properties, click the **Validate Connection** button.
6. Click **OK** to save the subsystem properties.
The dialog closes and you are returned to the Configuration browser main window.
7. With the desired OPC UA server selected, in the OPC server (available elements) pane, click the **Connect** button.
The OPC UA server appears in the left pane.

8. Select the OPC UA server in the left pane and expand the tree and locate the items that you wish to monitor.
9. Right-click each and select **Add node**
10. Click the **Disconnect** button.
11. Click the **Apply** button to save your changes to the configuration.

5.13 Exporting detector data

Detector data can be exported for further processing in a format (.CSV) editable in MS Excel

1. In the **File** menu of the Configuration Browser select **Export Detector Configuration...**
2. A windows dialog window opens for specifying the target directory for the export.
 - The default directory is **<Installation drive>:\MgtS\Export\Customer_Configuration \<Name of the configuration directory>** and the default filename is **AddressExport.csv**.
 - Change the path and filename if desired
 - Confirm your input with **OK**.
3. Answer the question dialog, whether you wish to write a header line containing column names to the file
4. The progress bar shows the number of exported detectors and the total number.

The Export contains the following data columns:

- Location
- Address
- Detector type
- Description



Notice!

Message pool, event log, protocol print, server, timers, operators and application launcher items are **NOT exported**.

The resulting file can be edited by columns in MS Excel or as a text file in a normal text editor.



Notice!

It is **not** possible to import detector data.

5.14 Diagnostic tools and event simulation

BIS offers several diagnostic tools and methods. In addition to reviewing the error and event logs (see *BIS Manager tabs, page 103*), the following functions are available:

- *Simulated alarms, page 51*
- *Operator alarms, page 52*

Simulated alarms

Simulated alarms are useful for testing the Associations (If-Then rules) in a BIS configuration, to test the display of message documents, or to train operators in message processing. The simulated alarm command in fact simulates only a state. Whether a simulated alarm is in fact generated depends on whether an Association exists that is triggered by the simulated state. For more details please consult the BIS Operation online help.

Operator alarms

An operator alarm is an alarm that is triggered manually by the operator in response to external information (e.g. a threat by telephone, or something the operator witnesses personally), and not automatically detected through a subsystem. For more details please consult the BIS Operation online help.

5.15 Structure and organization of the configurations

All files are installed in an installation directory (<INST DIR>). The default installation directory is C:\MgtS.

Runtime configuration

Directory	Description
<INST DIR>\Runtime_Config	The directory containing the currently loaded configuration. The contents of this directory change when the system loads a different configuration. NOTICE! Do not change the data in this directory. Your changes will be overwritten the next time the system is started or the configuration changed.

Configuration location

Directory	Description
<INST DIR>\Customer_Configuration*	After creating a configuration, the configuration data is saved in a separate sub-directory, which is created when the new configuration is made. The sub-directory can be given any name. The location of this sub-directory is <INST_DIR>\Customer_Configuration*. NOTICE! When entering the path, remember that the path name is case-sensitive.

Configuration content

Every configuration includes the following content:

File/Directory	Description
Configuration.crp	The configuration file. This file is stored in the root directory of the configuration. It is automatically encoded after every save, then decoded every time it is opened.
...\Documents	This directory contains the start pages. There are several sub-directories for location plans, detector icons, help documents, templates for action plans, event log displays, and the alarm printouts.
...\Documents\Action plans	This directory contains the action plan templates.
...\Documents\Floor plans	This directory contains the floor plans.

<INST DIR>\LogbookDB	This directory contains the files for displaying the event log content.
...\Documents\ MessageDetails	This directory contains the documents for displaying the messages in the message detail control: MessageDetails.htm: This document displays the message details for the selected message. EmptyDetails.htm: This document is displayed when no message is selected.
...\Documents\ Misc	This directory contains the miscellaneous document templates.
...\Documents\ Printouts	This directory contains the printout templates.
...\Documents\ Symbols	This directory contains the detector symbols for displaying in floor plans.

6 OPC: BIS Connector

6.1 Introduction and overview

The OPC Connector is a tool to facilitate the integration of any 3rd-party OPC server into BIS. It can perform arbitrary alphanumeric transformations of item values, and arbitrary topological transformations of namespace hierarchies. Thus it can make any Data-Access (DA) OPC server compatible with BIS, even those that use, for example, very deep namespaces, long node names or non-numerical leaf values.

The OPC Connector is bi-directional, enabling BIS both to read values from, and give commands to, the 3rd-party device.

Assumptions

As the goal is the connection of a BIS installation with a 3rd-party OPC Server this document assumes that both have already been installed on their respective computers.

Installers are assumed to have a basic knowledge of OPC and enough knowledge of XML that they can edit an XML file without invalidating its structure.

Scope of this document

- Functionality overview
- Installation and configuration of OPC-Connector
- Invocation from BIS

Functionality overview

The OPC Connector makes incompatible OPC servers BIS-compatible, even if the namespaces are very deep, the nodes have very long names or the leaves have non-numerical values. It functions as an intermediary or “wrapper” for the incompatible server: BIS sees only the OPC Connector, and the OPC-Connector translates for BIS all communication, read and write, with the incompatible server.

The OPC Connector also augments BIS functionality: it can read, analyze or resolve string values and bit vectors from otherwise incompatible OPC servers; it can parse these and create multiple item values from one. Conversely it can combine multiple item values on the OPC server into one numerical value for BIS.

The following graphic illustrates the overall architecture of a BIS installation with OPC Connector. Although illustrated separately here, the three main elements (1), (3) and (5) may all be installed on a single computer, if required.

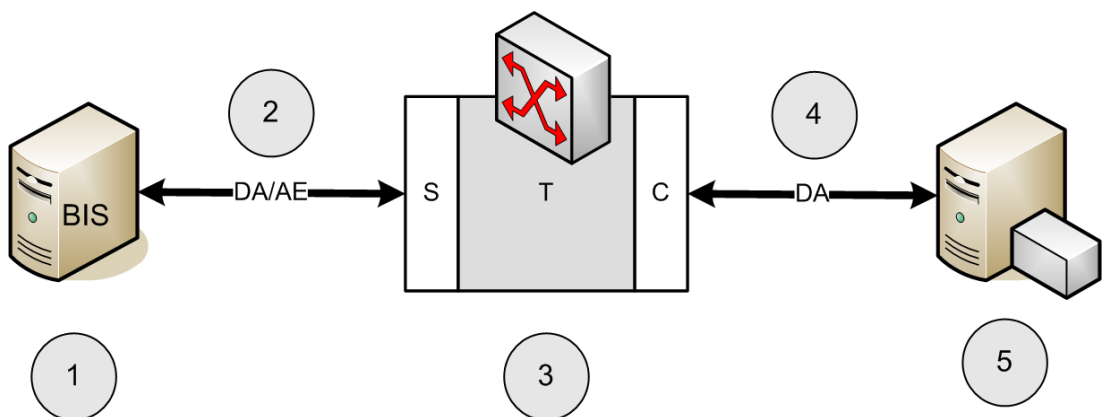

Figure 6.1: OPC Connector overview

1	The BIS server	4	DA(*) communication with 3rd-party OPC server
---	----------------	---	---

2	Combined DA/AE(*) communication as per the OPC common requirements specification	5	3rd-party OPC server with devices.
3	OPC Connector. – S = OPC server part – T = Transformer - a DLL (library of executable code) that performs the required transformations – C = OPC Client part		(*) DA = “Data Access” AE = “Alarms and Events”

6.2 Installation and configuration

OPC Connector is installed as an option within the main BIS installation. It requires no separate installation.

The **first** step in configuration is to **analyze** the namespace and the leaf node values of the 3rd-party OPC. Ascertain:

- which branches of the namespace can be ignored?
- where in the namespace the information is that interests you? What are the paths to this information?
- in what form(s) are the data in the leaf nodes that interest you? decimal numbers? binary numbers (bit fields)?, alphanumeric strings?
 - If strings or binary numbers, how should they be transformed in order to render them as decimal numbers for processing by BIS?
 - If decimal numbers, it may be that no transformation of leaf values is required. **Note:** in this case the editing of the `TransformationTypes.xml` file described below will not be required.

The **second** step is to edit the XML configuration files to the requirements of your 3rd-party OPC server. Two files are provided, and these contain code examples that cover all the commonest use-cases.

- `OPCConnector.xml`
- `TransformationTypes.xml`

The example code works with an example OPC Server `DemoOpcServer` that is also installed if the OPC Connector option is chosen during the BIS installation. For more details on starting the demo OPC server, see the final section of the OPC: BIS Connector chapter.

6.2.1 TransformationTypes.xml

This XML file is required if leaf values need to be transformed into decimal values for use by BIS. It contains XML descriptions of all the transformation types that the OPC Connector needs to perform. The `Name` attribute provides the link back to the `<Transformations>` section in `OPCConnector.xml`.

Currently 3 types of transformation are available:

- `NodeToLeaf` type, that is either
 - **BitFieldToLeaf** or
 - **RegExToLeaf**
- **LeafToNode**

Details on these transformation types are provided in the following sections.

Transformation type BitFieldToLeaf:

The OPC Connector converts a decimal number to a binary and then parses it to provide values for leaves in the BIS namespace. For instance, a decimal value of 11 is converted to a bit field of [1011], which in turn is interpreted to mean that the battery is on-line (1), the fuel level is not OK (0), the motor is on (1) and oil level is OK (1).

The first attributes of the description are

- Name of the transformation. The Name attribute is crucial, as it is referenced by the other XML file, `OPCConnector.xml`
- `ActivationState` : the default numerical state for the BIS leaf node associated with any bit in the bit field if that bit gets set to 1, either by a BIS Command (e.g. Set Value) or by the OPC server.
- `DeactivationState` : the default numerical state for the BIS leaf node associated with any bit in the bit field if that bit gets set to 0, either by a BIS Command (e.g. Set Value) or by the OPC server.

Note that these default states will be overridden by any `ActivationState` or `DeactivationState` present in the `<Transformation>` elements of individual bits (see below).

Thus the first lines of the `BitFieldToLeafTransformation` element might look like the following:

```
<BitFieldToLeafTransformation
  Name="BitFieldSmall"
  ActivationState="126"
  DeactivationState="125">
  ...
```

There follow a number of `<Transformation>` elements, a maximum of one for each of the bits in the bit field. Bits that have no `<Transformation>` element will be ignored by BIS.

Each bit with a `<Transformation>` element will become a leaf in the corresponding BIS namespace, and so is given a `LeafName` attribute that reappears as a leaf node in BIS.

Next comes a `<BitItem>` element containing a zero-based index, plus two possible numerical values (`ActivationState` and `DeactivationState`) for the associated BIS leaf node (`LeafName`), depending on whether this bit is activated (1) or deactivated (0). Note that `ActivationState` and `DeactivationState`, if present in the `<Transformation>` element, will override the same attributes in the parent element `<BitFieldToLeafTransformation>`.

For example, the following `<Transformation>` elements refer to the first and second bits in a bit field (bit 0 and bit 1).

```
<Transformation LeafName="Battery">
  <BitItem Bit="0"
    ActivationState="111"
    DeactivationState="118"/>
</Transformation>

<Transformation LeafName="Fuel">
  <BitItem Bit="1"
    ActivationState="113"
    DeactivationState="119"/>
</Transformation>
```

Transformation type RegExToLeaf:

An alphanumeric string is parsed to provide values for leaves in the BIS namespace. For instance, different strings containing the substring “Battery Voltage” could be transformed into the numeric values for corresponding BIS battery states.

```
<Transformation LeafName="Battery">
  <RegExItem RegExPattern="Battery Voltage low" ActivationState="111"/>
  <RegExItem RegExPattern="Battery Voltage high" ActivationState="112"/>
  <RegExItem RegExPattern="Battery Voltage OK" ActivationState="118"/>
</Transformation>
```

Use regular expressions (regexps) to parse strings and translate them into different BIS states. **Note** that the escape sequence `\b` (word boundary) is required, before and after, to delimit individual expressions containing digits. Failure to do this may result in unexpected matches, for example pattern `123` matching `12345`.

```
<RegExToLeafTransformation Name="RegExWithNumbers" ActivationState="133"
DeactivationState="134">
  <Transformation LeafName="6 or 13 or 123 or 4711">
    <RegExItem RegExPattern="\b6\b|\b13\b|\b123\b|\b4711\b"/>
  </Transformation>
  <Transformation LeafName="between 0 and 9">
    <RegExItem RegExPattern="\b[0-9]\b"/>
  </Transformation>
...

```

BIS commands for nodes transformed by NodeToLeaf transformations

For the BIS leaf nodes created by NodeToLeaf type transformations, commands are provided in BIS, and are invoked from the context menu by right-clicking the node. The commands are:

- **Set Value** (only for bit field transformations): Prompts for the value in BIS. OPC Connector writes the given value, as a decimal integer, back to the original OPC DA item of the 3rd party OPC server.
- **Activate** (only for bit field transformations): Sets the corresponding bit to “1”
- **Deactivate** (only for bit field transformations): Sets the corresponding bit to “0”
- **Set String Value** (only for RegEx transformations): Prompts for the value in BIS. OPC Connector writes the given value back to the original OPC DA item of the 3rd party OPC server.

Note that the setting of a leaf value on the 3rd party OPC server may of course trigger an immediate reaction from OPC Connector, depending on how often the leaf values are polled for changes.

Transformation type LeafToNode:

An arbitrary number of leaves is read and their values summarized (concentrated) to provide the value for a superordinate node in the BIS namespace. The structure of such a transformation is as follows:

- The top-level node <LeafToNodeTransformation> has an attribute for the transformation name (which is referenced from OPCConnector.xml) and an optional default value, which is a BIS state to be set if none of its conditions (<StateMapping> elements) are met.
It contains elements <StateMappings> and <CommandMappings>.
- <StateMappings> is a collection of <StateMapping> elements
- Each <StateMapping> element has a numeric TargetState for BIS, that is the value of the superordinate BIS node if the whole <StateMapping> returns TRUE.
It also has a rule for combining its subordinate <StateMappingItem> elements, (logical AND or OR).
- Each <StateMappingItem> element names its corresponding leaf in the 3rd-party OPC namespace and contains <StateRange> elements.
- Each <StateRange> contains any number of <State> elements, which are combined by a logical OR regardless of the combining rule given under <StateMapping>. In other words, in order for the <StateRange> to return TRUE it is only necessary for one of the <State> elements in the <StateRange> to correspond to the current values on the OPC server.
- Each <State> contains a regex pattern (with or without metacharacters). If RegExPattern contains no metacharacters then the match succeeds if it is a substring of the value on the 3rd-party OPC server.

An example of a <StateMappings> element:

```
<StateMappings>
  <StateMapping TargetState="130" CombiningRule="LogicalAnd">
    <StateMappingItem LeafName="Battery">
      <StateRange>
        <State RegExPattern="Battery Voltage OK"/>
      </StateRange>
    </StateMappingItem>
    <StateMappingItem LeafName="Fuel">
      <StateRange>
        <State RegExPattern="Fuel sufficient"/>
      </StateRange>
    </StateMappingItem>
    <StateMappingItem LeafName="Motor">
      <StateRange>
        <State RegExPattern="Motor Temperature OK"/>
        <State RegExPattern="Motor Speed OK"/>
      </StateRange>
    </StateMappingItem>
    <StateMappingItem LeafName="Oil">
      <StateRange>
        <State RegExPattern="Oil Pressure OK"/>
      </StateRange>
    </StateMappingItem>
  </StateMapping>
</StateMappings>
```

BIS commands for nodes transformed by LeafToNode transformations

As with the NodeToLeaf transformations, BIS OPC Connector can receive BIS control commands and write strings to the DA items of the 3rd party OPC server. With LeafToNode transformations however there exists an additional `<CommandMappings>` section in the transformation description, where new BIS control commands can be defined. This is structured as follows:

- The `<CommandMappings>` collection contains `<CommandMapping>` elements
- Each `<CommandMapping>` element names its command and contains `<CommandMappingItem>` elements.
- Each `<CommandMappingItem>` element names the target leaf node on the 3rd-party OPC server (`LeafName`), and the value (`State`) to which the leaf should be set.

An example of a `<CommandMappings>` element follows. The command “Reset fuel and oil” will become available in BIS as a command that can be invoked by right-click and writes to the respective OPC server.

```
<CommandMappings>
  <CommandMapping CommandName="Reset fuel and oil">
    <CommandMappingItem LeafName="Fuel" State="Fuel sufficient"/>
    <CommandMappingItem LeafName="Oil" State="Oil Pressure OK"/>
  </CommandMapping>
</CommandMappings>
```

6.2.2

OPCConnector.xml

This XML file contains a single element `<OpcConnector>` two sub-elements:

`<SourceOPCServer>` and `<Transformations>`.

`<OpcConnector>` has a single attribute `LowestHierarchyLevel`, which tells BIS whether the OPC Connector namespace terminates in groups, detectors, or in the individual sensors in those detectors. For instance, a fire detector can belong to a group of peers, and can contain 3 different sensors, which sense temperature, light and chemical changes respectively.

The `<SourceOPCServer>` element tells OPC Connector where to find the 3rd party OPC server, either on LOCALHOST or on a named computer. It also contains GUIDs (global unique identifiers) for the DA (data access) and AE (alarm and event) parts of the 3rd party OPC servers.

Thus the first few lines of `OPCConnector.xml` will look similar to the following:

```
<?xml version="1.0" encoding="UTF-8"?>
  <OpcConnector LowestHierarchyLevel="Detector">
    <SourceOPCServer ComputerName="LOCALHOST"
      DaGuid="{A49A67C1-9CA2-4503-A220-A07F2A1DAFFE}"
      AeGuid="{E8BBA3A4-16F0-4AC1-9FA2-A30771B2AFFE}"/>
```

The `<Transformations>` element contains all the transformations that the OPC Connector is to perform. Each of its `<Transformation>` sub-elements describes one of these transformations, using up to three attributes. These attributes are:

- `OPCItemPathSource`: The path, within the 3rd party OPC server’s namespace, of the node to be transformed
- `OPCItemPathTarget`: The path, within the BIS namespace, of the corresponding BIS node.

- TransformationTypeName: The name of the transformation as defined in the TransformationTypes.xml file.

The combination and the contents of these three attributes determine what kinds of transformations are possible. The following tables show which combination of parameters is required for which kinds of transformation. Eight transformation types are shown, **A-H** and described in detail below the table.

OPCItemPathSource			
OPCItemPathTarget			
TransformationTypeName			
Possible goal>	A) Ignore items on the OPC server.	B) Pass item values unchanged	C) Transform namespace but not leaf values

OPCItemPathSource			
OPCItemPathTarget			
TransformationTypeName		 (Bitfield)	 (RegEx)
Possible goals>	D) Transform leaf values but not namespace. (RegExToLeaf without subleaves)	E) "Bitfield parsing": Turn a decimal leaf value into a bit field, parse it and transform it into a set of decimal BIS subleaf values. (BitFieldToLeaf)	G) "String Differentiation": Parse a string value into a set of numeric BIS subleaf values. (RegExToLeaf)
		F) "Concentration": Use combining-rules to transform multiple leaf values into a single BIS (numeric) leaf value. (LeafToNode)	
			H) "String Analysis": Parse and analyse a string value, and write the result to a single BIS numeric leaf value (RegExToLeaf without subleaves)

Table 6.1: (table continues...)

A) Ignore items on the OPC server

In the simplest case, all that is required to filter out or ignore an item on the 3rd party OPC server is to leave it out of `OPCConnector.xml` entirely. These items will not be visible to BIS.

B) Pass item values unchanged

If an item on the party OPC server is mentioned in the first parameter attribute (`OPCItemPathSource`) but not in the other two, then it will appear in the namespaces of OPC connector and BIS, but will not be transformed or the namespace re-mapped in any way. Nevertheless the current value, and any changes, will be reported to BIS, and the BIS user may change the value of the item on the OPC server by right-clicking the item in the device hierarchy in BIS and selecting the command **Set value**.

This kind of transformation mapping is roughly equivalent to the functionality of the BIS State-forwarding OPC server.

The following is an example of this transformation type from `OPCConnector.xml` Note that the third parameter `TransformationTypeName` is absent:

```
<Transformation
  OPCItemPathSource="Source.Sample0.NoTransformation"
  OPCItemPathTarget=""/>
```

C) Transform namespace but not leaf values

If the first two parameter attributes (`OPCItemPathSource`, `OPCItemPathTarget`) are given namespace paths, but the third parameter is absent, then OPC Connector performs a mapping of paths, but does not transform the values at the leaf nodes.

This transformation type is useful for simplifying overly complex namespaces within BIS, or for shortening long item names.

The following is an example of this transformation type from `OPCConnector.xml` Note that the third parameter `TransformationTypeName` is absent:

```
<Transformation
  OPCItemPathSource="Source.Sample1.NamespaceTransformation.This.Is.A.Source.Path.String.With.A.Lot.Of.Hierarchy.Levels"
  OPCItemPathTarget="Target.Sample1.Short.Hierarchy"/>
```

D) Transform leaf values but not namespace

If the first and third parameter attributes are given values, but `OPCItemPathTarget` left empty, then the OPC server's namespace is mirrored in BIS, and the leaf value subjected to the transformation named in the third parameter (and defined in `TransformationTypes.xml`).

Example:

```
<Transformation
  OPCItemPathSource="Source.Sample0.Lighting"
  OPCItemPathTarget=""
  TransformationTypeName="BitFieldSmall"/>
```

E) "Bit field parsing": Turn a decimal leaf value into a bit field, parse it and transform it into a set of decimal BIS subleaf values (BitFieldToLeaf)

If all three parameters are set, and the transformation named under `TransformationTypeName` is defined in `TransformationTypes.xml`, then an integer on an OPC server's leaf item, can be turned into a bit field, and the bit field parsed into values for multiple BIS leaf items. There are two examples given in the `TransformationTypes.xml` in the BIS installation kit, namely `BitFieldBig` and `BitFieldSmall`.

```
<Transformation
  OPCItemPathSource="Source.Sample2.BitFieldToLeafTransformation.Building
"
  OPCItemPathTarget="Target.Sample2.Building"
  TransformationTypeName="BitFieldBig"/>
```

F) "Concentration": Use combining-rules to transform multiple leaf values into a single BIS (numeric) leaf value. (LeafToNode)

All three parameters are set. The transformation named under `TransformationTypeName` is defined in `TransformationTypes.xml`, It contains one or more `<StateMapping>` elements that are each complex patterns to be compared with the current leaf values on the 3rd party OPC server. If a `<StateMapping>` matches then the numeric value of its `TargetState` attribute is set in BIS.

```
<Transformation
  OPCItemPathSource="Source.Sample4.LeafToNode.Car"
  OPCItemPathTarget="Target.Sample4.Car Summary"
  TransformationTypeName="LeafToNode"/>
```

G) "String Differentiation": Parse a string value into a set of numeric BIS subleaf values. (RegExToLeaf)

If all three parameters are set, and the transformation named under `TransformationTypeName` is defined in `TransformationTypes.xml`, then a string on an OPC server's leaf item can be parsed using regular expressions, and any number of BIS leaf item states set as a result.

In `OPCConnector.xml` such a transformation will look similar to the following:

```
<Transformation
  OPCItemPathSource="Source.Sample3.RegExWithLeafs.Car"
  OPCItemPathTarget="Target.Sample3.Car"
  TransformationTypeName="RegExWithLeafs"/>
```

In `TransformationTypes.xml` there are examples, namely `RegExWithLeafs` and `RegExWithNumbers`.

In `RegExWithLeafs`, for example, the OPC Connector browses specific leaves (as specified by the attribute `LeafName`) on the 3rd party OPC server and sets different BIS states depending on what `RegExPattern` elements match the strings it finds there.

```
<Transformation LeafName="Battery">
  <RegExItem RegExPattern="Battery Voltage low" ActivationState="111"/>
  <RegExItem RegExPattern="Battery Voltage high" ActivationState="112"/>
  <RegExItem RegExPattern="Battery Voltage OK" ActivationState="118"/>
```

```

</Transformation>
<Transformation LeafName="Fuel">
  <RegexItem RegExPattern="Low on Fuel" ActivationState="113"/>
  <RegexItem RegExPattern="Fuel sufficient" ActivationState="119"/>
</Transformation>

```



Notice!

Cause of Hazard

Note that there is, by design, no “catch-all” or “else” clause. If none of the regex patterns match then no actions are undertaken

H) "String Analysis": Parse and analyse a string value, and write the result to a single BIS numeric leaf value (RegExToLeaf without subleaves)

```

<Transformation
  OPCItemPathSource="Source.Sample3.RegExWithoutLeafs.PLZ"
  OPCItemPathTarget="Target.Sample3.PLZ"
  TransformationTypeName="RegExWithoutLeafs"/>

```

In `RegExWithoutLeafs` the attribute `LeafName` is left empty in `TransformationTypes.xml`, so the OPC Connector instead parses the value of the single node it finds in the Transformation's `OPCItemPathTarget` attribute. Based on the regex parse of the string value, it sets BIS states to the integer given in the attribute `ActivationState`.

```

<RegExToLeafTransformation Name="RegExWithoutLeafs" ActivationState="148"
  DeactivationState="149">
  <Transformation LeafName="">
    <RegexItem RegExPattern="D-[8-9]\d{4}$" ActivationState="140"/>
    <RegexItem RegExPattern="D-7\d{4}$" ActivationState="141"/>
    <RegexItem RegExPattern="D-6\d{4}$" ActivationState="142"/>
  ...

```

6.3 Invocation from BIS

Adding OPC connector to a BIS configuration

BIS OPC Connector can be “browsed” in the same way as other OPC servers. This is not strictly necessary but has the advantage that BIS automatically starts the server for you when the configuration is loaded. If you choose not to add OPC Connector as a subsystem it will need to be started manually, as described below:

If you are unfamiliar with the procedure to browse a subsystem, follow the steps below:

Prerequisite: A BIS version 3.0 or greater has been installed, whereby the option to install the BIS OPC connector was confirmed during the installation.

1. In the BIS configuration browser select the Outlook button **Connections**
2. In the upper-left dialog pane, under **Connection servers**, right-click the server where OPC Connector resides, and select **Add subsystem...**
3. From the popup dialog's list of configurable OPC servers select **OPCConnector**
4. Click **OK**
Result: **OPCConnector** has appeared under the selected connection server
5. Click the **OPCConnector** icon

Result: Two dialog panes appear: **OPC server (available elements)** and **BIS addresses (chosen elements)**

6. Click the **Connect** button to “browse” the server.
Result: **OPCConnector** appears in the left pane.
7. Right click **OPCConnector** in the first pane and select **Expand all (browse all if not already browsed)**
Result: The entire namespace of OpcConnector as defined in `OPCConnector.xml` and `TransformationTypes.xml` is displayed in the left pane.
8. Right click **OPCConnector** in the first pane and select **Add all items**. Confirm your selection in the popup dialog.
Result: The entire namespace of **OPCConnector** is copied to the right-hand pane
9. Click the **Apply** button to commit the addresses to BIS.
10. Click the **Disconnect** button to stop browsing the server.
11. In the BIS Manager load this modified configuration

Monitoring OPC Connector from the BIS client.

Prerequisite: The BIS server is running the configuration that has been modified as per the previous section.

- ▶ In the BIS client, open the **Location overview** tab and select **Detectors without location** in the left pane.
Result: The devices, groups and detectors of the OPC Connector are listed in the main pane. Sort the **Address** column alphabetically, and look for addresses starting with OPCConnector

Familiarizing yourself with OPC connector using the “demo” OPC server

This BIS installation includes a “demo” OPC server that demonstrates the main features of BIS OPC Connector.

If OPCConnector has been added as a subsystem in your configuration, then the demo OPC server will be started by BIS when the configuration is loaded.

If OPCConnector has not been added by browsing, it may be started manually as follows:

The files can be found on the BIS installation drive under `MgtS\Connections`
`\DemoOpcServer\`

1. Back up the file `DemoOpcServer.xml` under an appropriate name, e.g. `DemoOpcServer_ORIGINAL.xml`
2. Copy the file `DemoOpcServer_OPCCConnector.xml` onto the file `DemoOpcServer.xml`, thus overwriting it.
3. Double-click `DemoOpcServer.exe` in the same directory. It will now set its DA item values according to the code in `DemoOpcServer.xml`

Using the continuous loop in the demo OPC server

DA item values can be set by a continuous loop defined in `DemoOpcServer.xml` or manually using the Softing OPC Client.

The Demo OPC server defines a namespace hierarchy and a loop in which DA values are written to the leaves of that namespace. The attribute `Delay` defines the period of the loop in milliseconds. If `Delay` is set to “0” or `Loop` set to “false”, then the leaf item values remain static unless set manually.

```
<DaItemValues Delay="1000" Loop="true">
```



```
<DaItemValue Path="Source.BitFieldToLeafSmall.Car" Value="1"/>
<DaItemValue Path="Source.BitFieldToLeafSmall.Car" Value="2"/>
<DaItemValue Path="Source.BitFieldToLeafSmall.Car" Value="4"/>
...
</DaItemValues>
```

Setting values manually using the Softing OPC client.

This BIS installation includes the Softing OPC client that can be used to set leaf values on an OPC server, and so to test BIS OPC Connector.

The Softing client, `SOClient.exe`, can be found on the BIS installation drive under `MgtS\Tools\Softing`

Prerequisite: A BIS version 3.0 or greater has been installed, whereby the option to install the BIS OPC connector was confirmed during the installation.

Prerequisite: The OPC Connector is running, either started by BIS (because it has been browsed into your configuration), or started manually. The continuous loop can but need not be in operation.

1. Start the Softing Client `SOClient.exe`.
2. In the main pane, **OPC Servers** tab, click **Local > Data Access V3**
3. Double-click **DemoOpcConnector DA**
Result: DemoOpcServer DA appears in the left pane with green icons showing that this OPC server is running
4. In the main pane, **DA Browse** tab, right-click **DemoOpcServer DA** and select **Add Items for all Tags**
Result: The various DA Items are listed on the **DA Items** tab
5. In the main pane, **DA Items** tab you may now write a value to one of the DA Items by left-clicking it, then entering a value in the text entry box upper-right corner, then clicking the **Write** button.

7 Common configuration recipes

BIS is a large and highly configurable integration platform in its own right. In this section we outline the steps for a small number of common configuration types. Your own configuration may require steps from more than one of these configuration types.

A A basic BIS configuration containing the essential features.

Configuration A: A basic BIS configuration, page 66

C A configuration which adds active location plans (floor plans) to configuration B.

The ability to deploy location plans is licensed separately. With it operators navigate within and control devices from a graphical map representation of the installation site.

Configuration C: Adds active location plans (floor plans) to configuration B., page 68

B A configuration with the following enhancements:

- Address lists: useful for manipulating logical groups of detectors and other devices.
- Symbols: useful for making devices more conspicuous and easily identifiable on user interface pages
- State/condition counters: useful for summarizing the overall status of many devices of the same type.

Configuration B: Includes enhancements from the basic package., page 67

D A configuration which adds dynamic html pages to configuration C.

The ability to deploy dynamic html pages in the BIS UI, e.g. “action plans”, is licensed separately. With it operators can be given prompt, clear instructions for dealing with rare, complex or dangerous emergency situations.

Configuration D: Adds dynamic html pages (e.g. action plans) to configuration C., page 69

7.1 Configuration A. A basic BIS configuration

The following procedure describes a basic BIS configuration which contains none of the optional BIS features that are licensed separately. It can be regarded as a common denominator for most BIS configurations.

Step#	Example configuration #1: Step descriptions
1	Verify that the prerequisites have been fulfilled: <i>Prerequisites of configuration, page 25</i>
2	Configure the event log size and backup options in the BIS Manager: <i>The Event log tab, page 105</i> and <i>Event log Administrator Settings, page 110</i>
3	Create an initial empty configuration: <i>Setting up an initial BIS configuration, page 30</i>
4	Import and activate any additional license features: <i>Licensing the BIS server, page 25</i>

Step#	Example configuration #1: Step descriptions
5	Configure the server structure, that is, the network of connection servers and others which are to participate in this BIS installation: <i>Server structure, page 116</i>
6	Define connections and assign addresses: <i>Connections and Addresses, page 135</i> and <i>OPC classic connections, page 45</i>
7	Define address lists: <i>Address lists, page 167</i>
8	Define detector types: <i>Detector type, page 149</i>
9	Define states: <i>States, page 145</i>
10	Define associations: <i>Associations (Jobs) - an overview, page 173</i> <i>General procedure for configuring Associations, page 178</i> For reference: <i>Example of tracking totals using Associations, page 180</i> <i>Example of configuring a security system using Associations, page 182</i>
11	Define operators and authorizations: <i>Operators, page 124</i> <i>Authorizations, page 118</i>
12	Configure event log entries and permissions: <i>Event log, page 194</i>

7.2 Configuration B: Includes enhancements from the basic package.

The following procedure describes a BIS configuration which refines addresses, detector types, states and associations with

- Address lists: useful for manipulating logical groups of detectors and other devices.
- Symbols: useful for making devices more conspicuous and easily identifiable on user interface pages
- State/condition counters: useful for summarizing the overall status of multiple devices of the same type.

The above enhancements belong to the BIS basic package and do not need to be purchased in addition.

Step#	Example configuration #2: Step descriptions
1	Verify that the prerequisites have been fulfilled: <i>Prerequisites of configuration, page 25</i>
2	Configure the event log size and backup options in the BIS Manager: <i>The Event log tab, page 105</i> and <i>Event log Administrator Settings, page 110</i>
3	Create an initial empty configuration: <i>Setting up an initial BIS configuration, page 30</i>
4	Import and activate any additional license features: <i>Licensing the BIS server, page 25</i>
5	Configure the server structure, that is, the network of connection servers and others which are to participate in this BIS installation: <i>Server structure, page 116</i>

Step#	Example configuration #2: Step descriptions
6	Define connections and assign addresses: <i>Connections and Addresses, page 135</i> and <i>OPC classic connections, page 45</i>
7	Define address lists: <i>Address lists, page 167</i>
8	Define detector types: <i>Detector type, page 149</i> and Define symbols: <i>Symbols and symbol-blinking, page 157</i>
9	Define states: <i>States, page 145</i> and Define state/condition counters: <i>Device state/condition counters, page 192</i>
10	Define associations: <i>Associations (Jobs) - an overview, page 173</i> <i>General procedure for configuring Associations, page 178</i> For reference: <i>Example of tracking totals using Associations, page 180</i> <i>Example of configuring a security system using Associations, page 182</i>
11	Define operators and authorizations: <i>Operators, page 124</i> and <i>Authorizations, page 118</i>
12	Configure event log entries and permissions: <i>Event log, page 194</i>

7.3

Configuration C: Adds active location plans (floor plans) to configuration B.

The following describes how to add active location plans to configuration B.

The above enhancements do not belong to the BIS basic package and need to be purchased in addition.

Step#	Example configuration #3: Step descriptions
1 - 12	Use the same steps as in <i>Configuration B: Includes enhancements from the basic package., page 67</i>
13	Define location tree structure; <i>Tree structure, page 130</i> Develop floor plans with their detector positions: <i>Configuring location plans (floor plans), page 77</i>
14	Map the detector positions in the floor plans to the detector addresses in the location tree structure. <i>Assigning graphic files and their layers to nodes in the location tree, page 132</i> <i>Detector placement, page 141</i>

7.4 Configuration D: Adds dynamic html pages (e.g. action plans) to configuration C.

The following describes how to add active location plans to configuration B. These enhancements do not belong to the BIS basic package, and need to be purchased in addition.

Step#	Example configuration #4: Step descriptions
1 - 14	Use the same steps as in <i>Configuration B: Includes enhancements from the basic package., page 67</i> and then <i>Configuration C: Adds active location plans (floor plans) to configuration B., page 68</i>
15	Create action plans and miscellaneous documents <i>Creating/Editing Action Plans and Action Buttons, page 80</i>
16	Map the action plans and the miscellaneous documents to locations. <i>Assigning action plans and miscellaneous documents to nodes in the location tree, page 133</i> <i>Detector placement, page 141</i>
17	Configure print options. <i>Alarm print, page 196</i> <i>Protocol print, page 198</i> <i>Assigning automatic alarm printouts to nodes in the location tree, page 134</i>

8 Template jobs

Description of the prerequisites and the configuration of **Template jobs** in the BIS system.

8.1 Introduction and overview

A **Job** in BIS is a kind of **Association**. A **Job** is a collection of IF-THEN rules which respond in real time to events and state-changes in the BIS system. Each of these rules must have a prerequisite “Meta-IF” condition called a **Trigger**. For this reason the rules themselves are often referred to as Triggers. Optionally each rule may contain IF, THEN and ELSE clauses, though of course without a THEN clause the rule can have no effect.

The Template job feature is a powerful way to create large numbers of related rules which differ only in their addresses and/or parameters e.g. rules for hundreds of hotel rooms or fire detectors.

The overall process for defining and using template jobs is as follows:

1. Template jobs are defined in the BIS Configuration Browser like conventional jobs, but using generic placeholders in place of narrowly defined parameters.
2. The template job is then exported to an Excel file, where each row can represent a rule and the respective columns can hold values for all the parameters required.
3. The rules are edited in Excel where it is relatively easy to create large tables of sequentially numbered items, e.g. `camera_1`, `camera_2`, `camera_n` or IP addresses `x.y.z.1`, `x.y.z.2` etc.
4. When the template job table is complete, BIS first checks it for consistency, and then it is re-imported into the Configuration Browser.
5. BIS then creates a virtual rule for each row in template job table, i.e. for each of the related doors, cameras etc.

8.2 Prerequisite software

Bosch Building Integration System (BIS)

BIS version 2.2 or higher.

Microsoft Excel

To use this feature Microsoft Excel (versions 2007 and later are recommended) must be installed on the machine where the BIS Configuration Browser is started. If not, then the BIS Configuration Browser will not allow jobs to be made into template jobs.



Notice!

A separate installation of the Template Job OPC server is no longer necessary as it is included in BIS versions 2.2 and higher.

8.3 Creating a connection to the Template Job OPC server

1. Start the BIS Configuration Browser
2. Select **Connections** in the left-hand Outlook bar.
3. Right-click the connection server name in the upper left server tree or click the **[+]** button to create a connection (i.e. an OPC Subsystem) for the Template Job OPC server.
4. In the **Select new subsystem** dialog select **Generic OPC Server**.
5. In the **Data Access** pane select **Bosch.TemplateJob.DA**

6. Click **OK** to close the dialog box.

Effect: The **Bosch.TemplateJobDA OPC** server is added below the Connection server that you selected.

Note: This OPC server is only needed for the creation of template jobs, and so only during configuration, not during runtime. Therefore its check box is automatically cleared to prevent it from starting automatically when the BIS application starts.



Notice!

Do not change the predefined subsystem name **BoschTemplateJobDA**

1. In the **Connection servers** tree (upper left pane), click **BoschTemplateJobDA**.
2. Press the **Connect** button above the middle pane, then right-click **BoschTemplateJobDA** server in the middle pane and select **Add all items** from its context menu.
3. **Effect:** The template parameter **Parameter** appears as an item within **BoschTemplateJobDA** in the middle pane. This parameter can be used as a placeholder within Associations in later steps.
4. Press the **Disconnect** button above the middle pane before proceeding to define template jobs.

8.4

Using placeholders for addresses and states in a job

Create a new job in the Configuration Browser as follows:

1. Select Configuration Browser Outlook bar > **General settings** > **Associations** in the upper left pane.
2. Click the **New** button next to **Job**, and give the job a new and unique name for better orientation in the Excel tables to be generated later.
3. Similarly click the **New** button next to **Trigger**, select **Type: Address** from the pull down menu, and give it a new and unique name in the **Comment** field of the pop-up window. Click **OK**.
Effect: The **Address selection** dialog appears.
4. In the **Devices** pane select `BoschTemplateJobDA`, and in the **Groups** pane select `Parameter`
5. Click **OK**
Effect: a dialog box appears where you can define the state transition (**From** <state-1>; **to** <state-2>) that will act as trigger for the current job.
6. If you wish these transition states (**From** and **to**) to be read from the Excel file, select **998-Template state** from the respective pull-down menus.

7. **Effect:** the following example shows a trigger with a template address (**BoschTemplateJobDA.Parameter**) to be triggered by a transition from any state (wildcard *) to **998-Template state** which will later be instantiated from the Excel table.

Trigger of type: 'Address' - Name: 'Set LSN'

Address

BoschTemplateJobDA.Parameter

All detectors of this group

group included

All sensors of this group

Transition of state

from * to 998 - Template state

8. Click the **Apply** button to save the trigger
9. Right-click the trigger and add any further IF, THEN and ELSE clauses you require.



Notice!

Ensure that all trigger names for template jobs are unique.

8.5

Marking a job as a Template Job

To turn a job into a template job, right-click the job's icon and select **Select template** from its context menu.

Effect: The job's icon will be overlaid by a red letter **T**. While a job is marked as a template job it can not be modified.

Enabling the modification of a template job

To enable the modification of a template job's parameters, IF-conditions, and THEN/ELSE controls, first reverse the above procedure by right-clicking and selecting **Unselect template** from its context menu.

Effect: Any imported template data for this job is removed from the configuration and the job can be modified. The letter **T** disappears from the icon.

8.6

Exporting placeholder data to an Excel file

When a job is thus marked as a Template job, with a letter **T**, the placeholder data can be exported to Excel. Proceed as follows:

1. Click the **Job** icon to invoke the dialog.

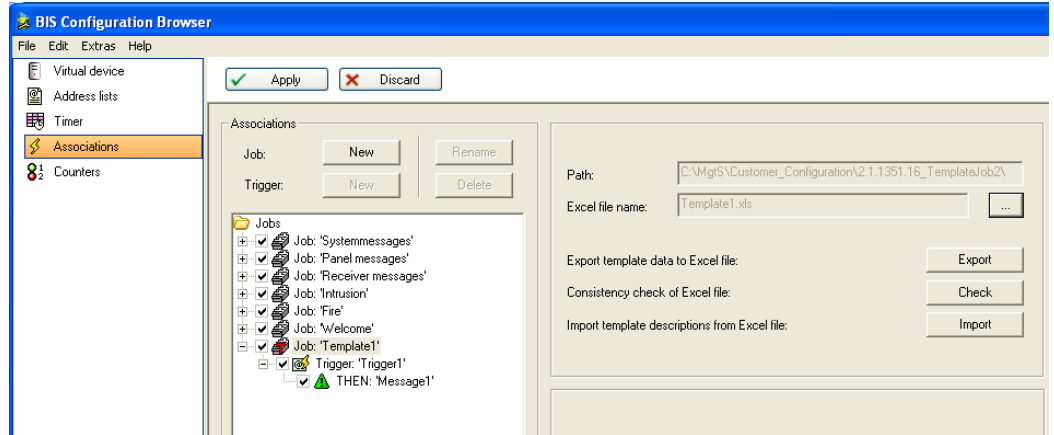

2. Click the [...] button and enter an appropriate path and filename. **Note:** The Excel file can only be used by the configuration if its path is within that of the configuration itself
3. Click the **Export** button to create the specially formatted Excel file, including named columns for placeholder data

The first two lines of the Excel file describe the data to be entered. The first line names the types, and the second line names the objects. The first column, marked Trigger actually contains the address of the trigger.



Notice!

The first two rows are created by the system automatically. Do not modify or overwrite them because this will invalidate the data structure and prevent BIS from using the jobs



Notice!

If a column is marked with (*empty column*) in the second row, do not enter any data in it, because here BIS is using only the column header in order to structure data for export or import.

	A	B	C
1	Trigger	To	
2	Trigger1	Trigger1	
3			
4			
5			
6			
7			
8			
9			
10			
11			
12			
13			
14			
15			
16			
17			
18			
19			
20			
21			
22			

In this example above we have one column for a trigger address called **Trigger** with the name **Trigger1**, and one column for a state **To** with the trigger name **Trigger1**. This corresponds to the screenshot below where both the trigger address and the **To** state have placeholders, but the **From** state has a wildcard asterisk.

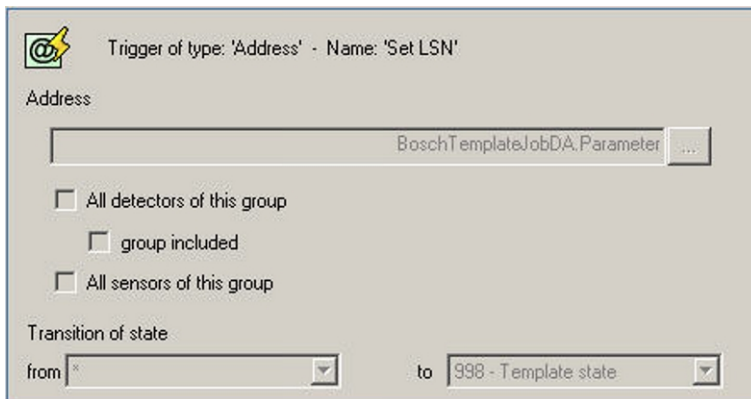

8.7 Entering real addresses and states in the Excel file

Now real addresses and states can be entered in the Excel file. All addresses and states must exist in the configuration and must be typed in as complete address strings. In the following example we have a LSN connection with the address strings “LSN.1.1” to “LSN.5.5” and use the state values from 11 to 55.

	A	B	C
1	Trigger	To	
2	Trigger1	Trigger1	
3	LSN.1.1	11	
4	LSN.1.2	12	
5	LSN.1.3	13	
6	LSN.1.4	14	
7	LSN.1.5	15	
8	LSN.2.1	21	
9	LSN.2.2	22	
10	LSN.2.3	23	
11	LSN.2.4	24	
12	LSN.2.5	25	
13	LSN.3.1	31	
14	LSN.3.2	32	
15	LSN.3.3	33	
16	LSN.3.4	34	
17	LSN.3.5	35	
18	LSN.4.1	41	
19	LSN.4.2	42	
20	LSN.4.3	43	
21	LSN.4.4	44	
22	LSN.4.5	45	
23	LSN.5.1	51	
24	LSN.5.2	52	
25	LSN.5.3	53	
26	LSN.5.4	54	
27	LSN.5.5	55	
28			

8.8 Checking the consistency of the Excel file

Before importing the data from the Excel file to the BIS configuration, a consistency check is necessary to ensure that all addresses and states are part of the BIS configuration.

Click the button **Check**

Effect: Inconsistencies will be signaled by a message box and logged to a text file that has the same name as the job and the extension `.TXT`

This file lists bad data, including the cells in the Excel file which contain addresses and states that do not exist in the BIS configuration.

8.9 Importing addresses and states from an Excel file



Notice!

Click Check before clicking Import

Although the Import button invokes a consistency check on the Excel file it is strongly recommended that you use the **Check** button first, to avoid any risk of corrupting the BIS configuration with inconsistent data.

Click the button **Import**

Effect: BIS generates one job for each line in the body of the Excel file. The configuration of the template job is complete, and the configuration can be used by the system. The icon of the job is overlaid with a green letter **T**.

The template job is set unmodifiable. To reverse this, see *Marking a job as a Template Job*, page 72

8.10 Notes and Limitations

Upper limit for Jobs, Triggers

The number of jobs and triggers which can be created by this feature is limited. The highest number that has been tested is currently 150,000 triggers.



Notice!

In order to reach this upper limit it may be necessary to install RAM in excess of 1 GB, depending also on the needs of other installed software.

Do not change the BIS configuration while a template job .XLS file is open

Close any .XLS files pertaining to template jobs before saving and reloading a BIS configuration. Having an open.XLS file in the configuration can prevent reloading.

Deleting addresses

If you delete addresses in the Configuration Browser it is necessary to check whether they are contained in the imported Excel files of your template jobs.

If this is the case then unselect the template job, remove the addresses from the Excel file, select the job again as template job and re-import the Excel file.

Use the **Check** button to produce a list of states and addresses missing from BIS. See *Checking the consistency of the Excel file*, page 75

Deactivating template jobs

A template job currently can not be deactivated by clearing its check box under **Associations > Jobs**. To deactivate the template job it is necessary to delete it.

Changing “monitored by camera” documents

A **monitored by camera** document cannot be changed while still associated with a camera. First delete the associated camera and then reconfigure the job with a different camera and the appropriate html document.

9 Customizing BIS operator interfaces

9.1 Authentication

In the Configuration Browser select Outlook bar: **Administration** > **Server Structure** to set the client authentication parameters.

In order to authenticate a user BIS first examines its own user data. If the user exists in the BIS user data, BIS will run a user authentication on the **login server**.

For this reason, if a user has different passwords on the login server and on the client workstation, it is his password for the login server which is required for logging into BIS.

Configuring a Windows Authentication Scenario with local users

When using Windows Authentication with a BIS login dialog, users must always enter the username / password combination they have on the **BISlogin server**. There is no need, as far as BIS is concerned, for the user account to exist on the client. For **domain users** e.g. "myDomain\johnsmith" the same rule applies: The login server tries to authenticate locally, which will work as long as these users are known to the **login server**.

Windows Authentication without password dialog

The **dialogless login** takes the credentials of the user logged in to the current **client** and sends them to the **server** (credentials can be considered as username and password for present purposes). The client verifies only that it knows the password, and does not transmit it to the server. Hence it is impossible to capture the user's password from this credential sending process.

When the **BIS server** receives these credentials, it looks into its BIS user database and tries to use the transferred credentials to authenticate the user locally on the server.

To Windows Authentication with a BIS dialogless login page, the user's name and password need to be identical on the login server and the client. To ensure this, we recommend the use of **domain users**.

Setting up a special Authentication method

To configure a BIS system to one of the three possible authentication methods (BIS authentication, Windows Authentication, Dialogless Authentication), the BIS login HTML file must be adapted. The file **Login.htm** is located in MgtS\HTML-Login and provides the functionality for BIS authentication. Please overwrite **Login.htm** with one of the alternatives provided: **Login_WindowsAuthentication.html** or

Login_AutomaticallyLogonCurrentUser.htm .

9.2 Configuring location plans (floor plans)

9.2.1 Creating location plans

Location plans (floor plans) are a substantial enhancement to any BIS installation. With them an operator understands much faster the location and potential consequences of an alarm state.

It is usually the site architect, and not the BIS configurator, who produces location plans and defines the names and position of detectors. It is then the job of the BIS configurator to map the sub-areas and device positions in the graphics to the locations and devices within the BIS configuration, see *Detector placement, page 141*. Therefore below we provide only a brief summary of the two important aspects of location plans for the BIS configurator:

- *Best practices for creating location plans, page 78*
- *Defining named sections, page 78*
- *Anchoring detectors in graphics using hyperlinks, page 78*
- *Saving the floor plan for use in the BIS client, page 79*

9.2.2

Best practices for creating location plans

Regarding the use of AutoCAD graphics we recommend the following practices to optimize ease of use and performance.

Ease of use

- Place information that is relevant to different purposes or persons on separate layers. A layer can then be displayed or hidden depending on the person viewing it. Fire detectors, and burglar alarms, for example, are usually best placed on separate layers.
- Give each layer a unique name according to a consistent, agreed nomenclature. For example, use a numbering scheme to reflect floors, areas and sub-areas.
- For consistency of zoom factors and other settings use plot templates.

Performance

- Keep the number of layers and objects as small as possible. For example, document only features that are essential for orientation, such as walls, doors, windows, and staircases.
- Likewise remove unessential legend tables, headers, external references (xrefs) and other hyperlinks.
- In any drawing file the number of 3D hyperlink symbols should not exceed 300. The number of 2D hyperlink symbols should not exceed 500.
- Use only standard fonts and only colors defined by the respective layer.
- The size of a drawing file should not exceed 1MB.

9.2.3

Defining named sections

In the floor plans, **named sections** can be defined which you can assign like an independent graphic to a location in the location structure (for example, the individual rooms of a floor can be created as named sections).

1. Open AutoCAD and create a .dwg file.
2. Draw the desired floor plan.
3. From the main menu, select **View**, then **Named Views...**
4. Click Button: **New**, then in the **New View** dialog box select **Define window**.
5. Click the arrow icon. Drag a rectangle around the named section, then click once to complete the rectangle.
6. Right-click to return to the **New View** dialog box.
7. In the **View Name** field, enter a name for the named section. Close the dialog boxes by clicking OK.



Notice!

Do not use the period (.), asterisk (*), or question mark (?) symbols in the names of named sections.

9.2.4

Anchoring detectors in graphics using hyperlinks

If displaying detectors on the floor plans, anchor them in the graphics using AutoCAD's hyperlink function.

1. Open AutoCAD and create a .dwg file.
2. Draw the desired floor plan.
3. To anchor a detector in the graphic, draw a square of the size of the future detector icon. Position the square where the detector graphic is to appear.

4. On the **Insert** menu, select **Hyperlink**. The mouse cursor changes to a small rectangle. Click the square you drew in the previous step to select it. Press Enter to confirm the selection. The **Insert hyperlink** dialog opens.
5. Enter a name for the hyperlink in the **Type filename or name of website** field by concatenating the connection and detector point names using a period character “.” as separator. See the examples below. This reduces configuration effort because BIS is then able to assign the detector names automatically.
Examples of well-formed BIS detector names:
 - **UGM.27** = UGM connection, Group 27
 - **UGM.UEZ2.35.2** = UGM connection, subsystem UEZ2, group 35, detector 2
6. Remove any text from the **Text to display** box if you do not wish text to appear in the location plan.
7. Select the **Use relative path for hyperlink** check box.
8. Click OK to close the **Insert hyperlink** dialog.



Notice!

Do not use the **asterik (*)** or **question mark (?)** symbols in the names of named sections. Only use the **period (.)** as a separator.

9.2.5

Saving the floor plan for use in the BIS client

To become viewable in the BIS client an AutoCAD source file, in DWG format, must be “plotted” to a viewable format e.g. DWF. Note however that the plotting process is not reversible. Hence you should always back up both the source files and the viewable/plotted files.

Perform the following procedure in AutoCAD to generate the .dwf viewable format:

1. Click menu: **File > Plot...** to open the **Plot** dialog box.
2. Depending on the version of AutoCAD you are using, select the appropriate plotter name in the **Plot - Model** dialog. If the required plotter name is not in the list it may need to be installed. In this case please consult a knowledgeable AutoCAD user. The table below gives recommendations for plotter names.

AutoCAD version	Recommended plotter name
AutoCAD-LT 2000 to 2006	Whip 3.1 compatible
AutoCAD-LT 2007	Standard R14
AutoCAD-LT 2008 and later	DWF-eView (optimized for view) or DWF-ePlot (optimized for plot)

- ▶ Make the necessary entries, e.g. for paper size and click OK. When plotted the filename is automatically given the **.DWF** suffix.



Notice!

DWF files created with plotter name **DWF6-ePlot** are currently not displayable in the BIS location overview.

HSF format

The viewer in the BIS client can display location plans in either **.DWF** or **.HSF** formats, but **.HSF** format gives better performance. The BIS Configuration Browser provides tools for converting files, or folders of files, to **.hsf** format.

- Menu: File > **Convert DWF to HSF** > **Convert DWF files to HSF**
- Menu: File > **Convert DWF to HSF** > **Convert DWF folder to HSF**

9.3**Creating/Editing Action Plans and Action Buttons****Differences between Miscellaneous Documents and Action Plans**

An action plan defines the steps to be performed when processing a message. It may also contain macros, which are dynamic data (for example, the date) that are placed in the message whenever the action plan belonging to a message is displayed.

As opposed to miscellaneous documents, an action plan can affect the message handling process. There can only be one action plan per message, but any number of miscellaneous documents.

After processing the respective message its action plan is stored as a graphic file in the database. A miscellaneous document is stored as an HTML file including all its original functions.

Creating Action Plans

An action plan is always associated with a Location. To help you get started there are numerous templates (htm files) available, which can be adapted to your needs. The templates are stored in the directory: <Installation_Drive>:\MgtS\Customer_Configuration\<Configuration_name>\Documents\Action plans. It is advisable to copy one of these to a different filename in advance, or as described in step 4 below.

1. In the Configuration Browser click **Locations** > **Tree Structure** and select the desired location in the location tree.
2. Then in the documents pane click button: **Modify...** .
The **Selection of documents** window opens.
3. In the Documents pane of that window, click button : **New** and select **Action plan** from the **Document type** popup.
4. Right-click and drag one of the action plan templates to create a copy of it in the same window. Select it (or one of your own previously created htm files) and click **Open**. The file name is entered in the **File name** text box in the **Selection of documents** window.
5. Click in the Selection of documents window and **Apply** in the tree structure dialog.

Editing an Action Plan

Bosch recommends you adapt a template action plan to your needs. Most HTML editors can be used, from Microsoft Expression Blend down to Microsoft Front Page 2002. Examples in this document refer to Microsoft Front Page.

- Frames are not recommended when used for printouts because the frame contents may not print completely.
- On larger action plans, use navigation links to jump between sections of the action plan page. Script languages supported by Internet Explorer can be used to create dynamic effects on the page.
- (Optional) To organize and locate your files more easily, add the prefix **A-** to all action plan filenames.

NOTE: Only one action plan can be used at each location for each status. For example, for one location you can have one action plan for access denied messages and one for intrusion messages, but not two actions plans for access denied messages. Use miscellaneous documents for this purpose, if required.

Using Images in Action Plans

If an action plan contains images (.jpg or .gif images, for example), you must store the images in the **/Documents/Action plans** directory of the selected configuration. Bosch recommends that the action plan contain a relative link to the image (**/Documents/Action plans/image_name.gif**, for example).

Using Macros

Macros are placeholders in action plans, documents, or templates which are replaced with the relevant information at runtime (for example, the date).



Notice!

Of the following macros, (A), (B), and (C) can be used in action plans, documents, and templates. Macro (D) can only be used in templates.

(A) Information in the Message

Information in the Message	Example	Macro/Function
Complete address	LSN.UGM2.44.5	@Address#
Complete location path	BIS/North-Site/Building 6/ Main office	@LocationPath#
Name of location node	Main office	@Location#
Alarm time	13:51:55	@AlarmTime#
Alarm time in GMT	13:51:55	@AlarmTimeGMT#
Alarm date	13.02.2002	@AlarmDate#
Name of the line status	External fire	@State#
Number of the line status (decimal)	16	@NumState(Dec)#
Number of the line status (hexadecimal)	0x10	0x@NumState(Hex)#
Short information of the address	Detector gate 4	@PointText#
Detector type	Optical smoke detector	@DetectorType#
Triggering device	LSN.UGM2	@Device#
Detector group	44	@Zone#
Detector	5	@Point#
Sensor	2	@Sensor#

(B) Optional Information in the Message

The system can also interpret OPC attributes of a message using macros. Whether a particular attribute is present, though, depends on the reporting OPC server. If a macro is triggered at run time, but the OPC server has not sent the attribute with the message, the macro is removed from the action plan, document, or template.

**Notice!**

Macro notation:@OPCAAttribute(Name)#, where “Name” is the name of the OPC attribute. For example, display the cardholder number, cardholder name, or video archive name. OPC servers usually transmit these values as attributes.

Every OPC server sends the following OPC attribute with every message:

Information in the Message	Example	Macro/Function
The currently reported value (Current Value = CV), before it was mapped to a line status. In the case of a temperature sensor, for example, it is the measured temperature (61 degrees).	61	@OPCAAttribute(CV)#

The LSN-OPC server sends the following OPC attribute with every message:

Information in the Message	Example	Macro/Function
Number of sub-addresses	5	@OPCAAttribute(AnzahlUA)#

Attributes of other OPC servers can be found in each server’s own documentation.

(C) Other System Information

For project-specific solutions, additional scripting options are available using the BIS client object model. Contact Bosch Technical Support for more information.

Requirements for Inserting Action Buttons

You can insert an action button on the user interface, or inside of an action plan or miscellaneous document. Action buttons can perform various control commands to simplify usability at the client workstation. You can also access action buttons by using scripting languages. For example, an operator can open a barrier by clicking on a button or graphic.

You must have already dialed into BIS once from a client PC, so that the action button control element is installed on the system.

**Notice!**

The ActiveX controls are only visible i.e. can only be used if the BIS client was started (installed) in the machine, where FrontPage is running.

Inserting an Action Button with FrontPage

Perform the following procedure to insert an action button:

1. Open the document. Move the cursor to the position in the action plan where the action button will appear. On the toolbar, select **Insert -> Web Component**.
2. In the **Component Type** field, select **Extended control elements**.
3. In the **Control Element** field, select **ActiveX control element** and click **Next**.

- From the list of available control elements, choose **A1_Actionbutton**. A successfully inserted action button appears:



If the list of control elements does not include the entry **A1_Actionbutton**, click the **Edit** button and select the appropriate check box in the list. Click **OK** to confirm. The entry appears in the list of control elements.

- Right-click or double-click the button icon. Select the submenu **Properties: ActiveX control element..**, to define the action button more precisely.
- On the **General** tab, select the system authorizations that define who may use the action button. The assigned authorizations appear in the left field underneath **Button authorizations**.

When you open the Properties dialog for the first time, the system asks you to identify the configuration folder so that the configured associations are loaded.

- Choose the system commands that the user can perform from the action button. You can assign multiple commands to one action button, which will be executed in the assigned order. The commands appear in the left field underneath **Button commands**.

When you select a system command, a new dialog asks you to set the command parameters (for example, if the command is “Control Door”, the parameter could be “open” or “close”). If you would like to do this, de-select the **Keep macro** check box and make your entries. If the check box remains selected, the user is asked to enter the command parameters when he clicks the action button.

The same applies to the address entry. If you do not wish to enter an address, close the dialog by pressing **OK** (without address). The user will be asked for the address when he clicks the action button. If **Cancel** is selected the chosen command is not taken.

- Choose how the action button should behave by selecting the appropriate check boxes. The check boxes have the following meanings:

Check Box	Meaning
Mandatory	If this option is selected, a message cannot be deleted until the user has operated the action button.
Repeatedly clickable	If you select this check box, the user can operate the action button repeatedly. Otherwise it will be disabled immediately after the first click.
Parameters from message	If a message is displayed upon pressing the action button, the “line status” and “address” parameters are copied from the displayed message (e.g. in the case of an action button for manual reset of a detector). Action buttons have a “hidden” property. Operators cannot click on hidden buttons because they are invisible. Hidden buttons can, however, be called using a script.

- ▶ In the **Button Text** field, enter the text to appear on the action button, then close the dialog box by clicking **OK**.

9.4 Setting up Workflows

Introduction

If a message requires the attention of multiple BIS operators with different responsibilities, the operator who receives the message may pass it to another Authorization group by right-clicking the message and selecting **Workflow** from its context menu. He then chooses a recipient from a list of available authorizations.

Messages may also be passed to the same Authorization group if a peer operator is to process it, or the same operator at a later time. An operator can not log off BIS if he still has unaccepted (New) messages, but can circumvent this restriction by putting the message in Workflow.

Setting up a Workflow

For a Workflow to function as described the following elements need to be configured.

Element	How to configure
A message	Messages are typically generated by Associations, which in turn are triggered by a state-change at an address. See <i>General procedure for configuring Associations, page 178</i>
One or more Authorization groups	See <i>Authorizations, page 118</i> Note: The default authorization groups, e.g. Administrators, can of course also participate in workflows.
(Optional but useful) An Action plan associated with the location of the detector that generates the message.	See <i>Creating/Editing Action Plans and Action Buttons, page 80</i> As described in the same section, some buttons in action plans may be restricted to certain Authorization groups, so that the passing of a message by Workflow becomes necessary for the resolution of the message.

9.5 Creating/Modifying Workstation-Specific Interfaces

What are Workstation-Specific Interfaces?

Because operators can log onto BIS from different locations, their workstations can, for example, have a different screen resolutions. In addition, different user authorizations may also require interfaces with extended or limited functions. For example, you can design a user interface with 1024 by 768 pixels resolution differently than a 1600 by 1200 pixels resolution interface so that the screen elements display properly in both resolutions. See the following list “Available controls” for more details on the standard elements of BIS.

You can create user interface “packages” containing the same or different pages. Packages are sets of pages with different screen resolutions. When an operator logs in, BIS checks the allocation and directs the operator to the appropriate home page.

Tips for creating pages

- Bosch recommends you adapt a template action plan to your needs. Most HTML editors can be used, from Microsoft Expression Blend down to Microsoft Front Page 2002. Examples in this document refer to Microsoft Front Page
- When designing the HTML interface page, work in design mode. This means that the controls you put in place are only displayed through a bitmap representation. Their functioning cannot be tested in this mode because there is no contact with the running BIS server.

- It is best to place the display controls (ActiveX control elements) in absolute positions (select **Format > Position > Positioning method > Absolute**). You can resize all BIS controls.
- If necessary, place action buttons on the interface pages.
Click here for more information on: *Creating/Editing Action Plans and Action Buttons, page 80*
- Operator interface pages are stored on the server in the directory **<INST_DIR> \Customer_Configuration\<Config_Name>** . Select an operator interface page with the Configuration Browser.

Available ActiveX Controls

Add these ActiveX controls to your HTML page using an ActiveX capable HTML editor such as FrontPage.

To edit the properties of the elements after positioning, right-click on the element.



Notice!

The A1 ActiveX controls are not fully installed until the first invocation of the BIS Client. Start the BIS Client with the current BIS version to ensure that these controls are installed.

Control	Function	Repeatedly Placeable
A1_ActionButton Control	Button to which control operations are assigned.	Yes
A1_Buzzer Control	Button for turning off buzzer or sounds.	Yes
A1_Counter Control	Displays sum counters.	Yes
A1_Device View Control	Displays device overview	No
A1_Display Container Control	Document display which can contain four different elements: <ul style="list-style-type: none"> - Equipment overview - Location graphic - Action plans - Other documents 	Yes
A1_Document Select Control	To select the displayed miscellaneous documents.	Yes
A1_Exit Control	Button for exit the frame	Yes
A1_Floor Plan Control	Displays floor plan frames	Yes
A1_Frame Control	Button for operators	Yes
A1_Help Control	Opens the online help.	Yes

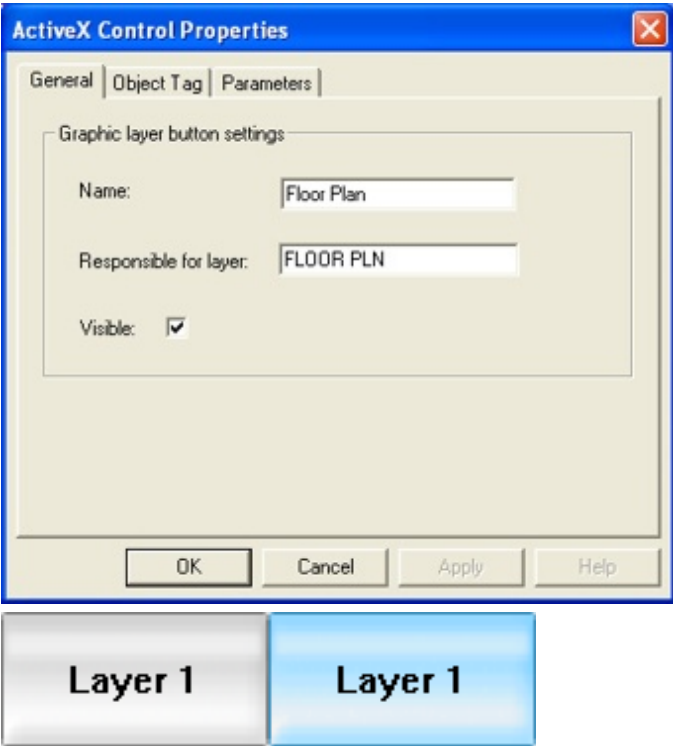
<p>A1_HtmlClient Control</p>	<p>This control shows additional message details to the selected message. Two HTML pages are used, which are stored in <code><INST_DIR>\Customer_Configuration\MyConfig\Documents\MessageDetails:</code> MessageDetails.htm: This document displays the message details of the selected message. EmptyDetails.htm: This document is displayed if no message is selected. NOTICE!</p> <ul style="list-style-type: none"> - In the control's properties, it is necessary to select View of message details. - It is possible to customize these HTML pages. This is a very flexible control that requires advanced knowledge. A further description of this control is beyond the scope of this online help document. For information and assistance with Subscription Controls, please contact Bosch Security Systems. 	<p>Yes</p>
<p>A1_LayerButton Control</p>	<p>Allows you to create a button that switches the visibility of a location overview map layer on or off. The properties are:</p> <ul style="list-style-type: none"> - Name of the button (text that shown on the button) - Name of the controller layer - Initial visibility state (on or off)  <p>Example: Layer 1 is visible, if the button is active (right).</p>	<p>Yes</p>
<p>A1_Loader Class</p>	<p>Loading of components</p>	<p>Yes</p>

<p>Controls: A1_Message (old), A1_MessageList (default)</p>	<p>Displays messages. NOTICE! The message controls A1_Message and A1_MessageList can not be used together on the same HTML index page. A1_MessageList is included by default in the index pages for every screen resolution.</p>	<p>No</p>
<p>A1_MessageList Control</p>	<p>Displays messages in a list. (This is the standard control.)</p>	<p>No</p>
<p>A1_Subscription Control</p>	<p>Subscribes the current line condition of one or more addresses. You can access this information using Java Script to display the addresses' line condition changes within action plans or any other HTML operator interface page (Workstation Interface, miscellaneous documents, and so on). This allows you to provide the operator with visibility to the line condition of any device without relying on the Location overview or the Device overview. NOTICE! The A1_Subscription control can only be used on the same page as the A1_Message control or the A1_MessageList Control. Position the message control above the A1_Subscription control to avoid errors. Examples for the usage of the Subscription Control can be found in <INST_DIR>\Customer_Configuration\MyConfig\ Documents\Action_plans\Subscription_Sample.htm. NOTICE! This is a very flexible control that requires advanced knowledge of Java Script that is beyond the scope of this online help document.</p>	<p>Yes</p>

9.6 Advanced BIS scripting options

Beyond the scope of this document are certain advanced options for interacting with BIS via JavaScript embedded in HTML-based UI customizations. The following are brief summaries. If you require this kind of functionality please consult Bosch Technical Support.

9.6.1 Subscribe to Address States Using JavaScript

It is possible to subscribe to one or more addresses using JavaScript. If any of the subscribed addresses changes state, a predefined event handler is called. For more information, consult Bosch Technical Support.

9.6.2 Change Location Tree Selection Using JavaScript

An automation object model is included with Internet Explorer on the client workstation PCs. The user interface HTML pages can access this object model, making it possible for the operator to easily navigate to favorite locations in the location tree. For more information, consult Bosch Technical Support.

9.7 Displaying raw OPC data

Introduction

“Raw” fluctuating analog data (integers, floating-point and text) can be displayed in real time in the BIS operator interface using JavaScript. The BIS installation provides two resources to help you in implementing this feature in your own operator interfaces:

- an example index page containing JavaScript and graphical display widgets from the public domain.
- a demo OPC server to feed values to this index page.

This section describes how to set up and run BIS with these resources.

Assigning the example index page to an operator.

In order to be used at all, the example index page needs to be assigned to an operator.

Prerequisite: A configuration of BIS version 3.0 or higher loaded in the BIS Configuration Browser.

1. To create a new BIS operator account click **Administration > Operators**, and click the **+** button above the list of current operators. Give the new operator an appropriate name. If a suitable operator already exists, skip to step 4.
2. Click the new operator in the list of operators
Result: The **General operator settings** dialog appears.
3. In this dialog, assign authorization and user profile from the pull-down menus.
4. Click the button **Manage**
Result: The **Manage operator profiles** dialog appears.
5. Set the following value for **Default page** using the file browser at the end of its input field.

```
<installation drive>:\MgtS\Customer_Configuration\  
<configuration name>\Documents\index_SampleAnalogValues.htm
```



Notice!

index_SampleAnalogValues.htm

This .HTM file contains not only the BIS UI layout with and the example JavaScript code, but also brief instructions on how to set up this demo.

Setting up the Demo OPC Server to supply analog values

In <Installation Drive>:\MgtS\Connections\DemoOPCServer\ do the following:

1. Back up your original DemoOpcServer.xml to a different name e.g.
DemoOpcServer_ORIG.xml
2. Rename SampleAnalogValue_DemoOpcServer.xml to DemoOpcServer.xml

Browsing the Demo OPC server

Prerequisite: The same configuration of BIS version 3.0 or higher loaded in the BIS Configuration Browser.

1. Add the OPC server **DemoOPCServer** as a new subsystem, following the usual browsing procedure described in *Creating connections and addresses by browsing, page 136*
2. Be sure to **add all values** to the OPC server and then **disconnect** the BIS Configuration Browser from it.

(Optional) Creating a new detector type “StringValue” with new state mappings for the transmitted strings

As the purpose of this demo OPC server is to transmit arbitrary, previously unmapped values, there now follows an optional step, the purpose of which is to suppress the error-log messages that BIS would normally produce in such cases. To do this we map those strings that we wish to transmit to BIS onto arbitrary numerical BIS states.

Prerequisite: The same configuration of BIS version 3.0 or higher loaded in the BIS Configuration Browser

1. Click **Infrastructure** > **Detector types**.
2. Select **DemoOPCServer** in the Detector types list and click the **New** button above it. Name the new detector type **StringValue**
3. In the **State mappings** tab, in the lower right corner, click the **+** button to add a new state.
4. In the ensuing dialog box, select data type **string** from the **Data type** list, select radio-button **Single value** and enter **Test** in the text box
5. Select an arbitrary state from the list of states and click **OK**.
Result: The **State mappings** list receives a new element **Test** in the **Reported states** list,
6. Repeat the last three steps to add the list elements **OPC**, **Value**, **Current** and **Integration** in the **State mappings** list.
7. In the main **Detector types** dialog, click the **Apply** button.
8. Click **Connections** > **Connection servers**. Locate and select **DemoOPCServer**
9. In the **BIS addresses (chosen elements)** pane, expand the **DemoOPCServer** tree and select the address `DemoOPCServer.OPCAnalogValue.Demo.Text`
10. In the **Detector type** pull-down menu, set the detector type of the address to **StringValue**.
11. Click the **Apply** button.

Notice!

Changing the strings in the Demo OPC server

Note that the strings **Test**, **OPC**, **Value**, **Current** and **Integration** here are arbitrary strings in `DemoOpcServer.xml` in the section `OPCAnalogValue.Demo.Text`. If you change them, ensure they are changed in both the XML file and **Infrastructure** > **Detector types** to avoid error-log messages.



Running the Demo

1. Reload the configuration and open the BIS Client as the operator defined above.
 2. Click the **Subscribe** button next to any or all of the analog values that you wish to see in the BIS Client.
- ✓ **Result:** In a continuous loop the scripts in `index_SampleAnalogValues.htm` display the values defined in `DemoOpcServer.xml`

Address:
 Result: 82

Address: DemoOPCServer.OPCAnalogValue.Demo.Numbers

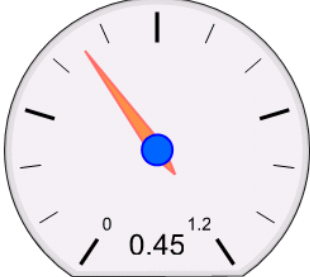

Address: DemoOPCServer.OPCAnalogValue.Demo.Numbers

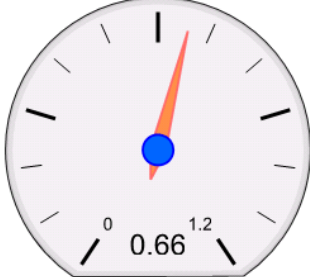

Address: DemoOPCServer.OPCAnalogValue.Demo.Numbers

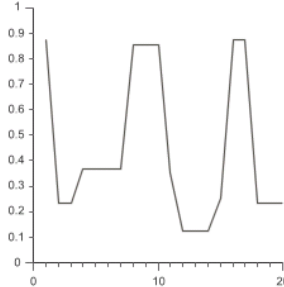

Address: DemoOPCServer.OPCAnalogValue.Demo.Numbers

Test

9.8

HTML5

Introduction

As of version 4.5 BIS supports HTML5 in the BIS client, and provides a tool to convert existing BIS HTML and JavaScript files to HTML5.

Only those files will be converted that are in the BIS `MgtS` folder or one of its subfolders.

Only BIS system files will be converted.

The original HTML files are backed up to a separate folder. The conversion can only be reversed by restoring the original files to their original locations. Any changes you made to the HTML5 files after conversion will be lost.

Prerequisites

- BIS version 4.5 or later with access to the installation medium.
- If using a Multi-server BIS system, ensure that both provider and consumer servers use the same version of HTML.

Procedure for conversion

1. On each computer for HTML conversion, stop the BIS client and server completely
2. To start the tool execute the following file from the BIS Installation medium:
3. `_Install\Tools\HTML5Converter\HTML5Converter.exe`
4. The splash screen of the tool describes its scope and limitations. Select the check box to confirm that you have read and understood them.
The **Start conversion** button is activated.
5. Click the **Start conversion** button.
A popup-window confirms success or failure of the conversion.
6. Click the close button **X** in the top-right corner to close the tool.

If successful, the BIS files are converted, and the original HTML files are copied to subfolders of the folder:

`\MgtS\BackupBeforeHTML5\<date-time in ISO 8601 format, e.g. 20170930182521>\`

Procedure for restoring original HTML files.

1. On each computer for rolling back the conversion, stop the BIS client and server completely
2. To start the tool execute the following file from the BIS Installation medium:
3. `_Install\Tools\HTML5Converter\HTML5Converter.exe`
4. The splash screen of the tool describes its scope and limitations. Select the check box to confirm that you have read and understood them.
The **Rollback** button is activated.
5. Click the **Rollback** button, and click the **Yes** button in the pop-up window to confirm
A popup-window confirms success or failure of the rollback.
6. Click the close button **X** in the top-right corner to close the tool.

Before restarting the BIS system

Before restarting the BIS system after conversion or rollback, clear the local cache of the browser. Proceed as follows:

1. In the Internet Explorer, go to menu: **Tools > Internet options > tab: General**
2. In the **Browsing history** pane of the pop-up window, click the **Delete...** button.
3. In the **Delete Browsing History** pop-up window, select the check box **Temporary Internet files and website files**.
4. Click the **Delete** button and close the browser.

10 BIS multi-server systems

Concepts and overview

For the main concepts and an overview of BIS multi-server technology, see *BIS multi-server systems*, page 11



Notice!

Necessity of performance testing

Performance depends on a variety of factors including number of servers, number of records, complexity of records and bandwidth of the network.

Bosch urgently recommends that the performance of multi-server installations be thoroughly tested under realistic loads before productive use, and an adequate network infrastructure put in place.

10.1 Providing information to other BIS single server systems

To provide some or all of the addresses of one BIS single server system to others, it is of course necessary that there be a network connection between them.

Secondly the Provider system must create a configuration file that details which addresses should be provided, that is, visible to and usable by Consumer servers.

Overview of the configuration dialog for Provider servers.

The following describes the various parts of the configuration dialog and their functions:

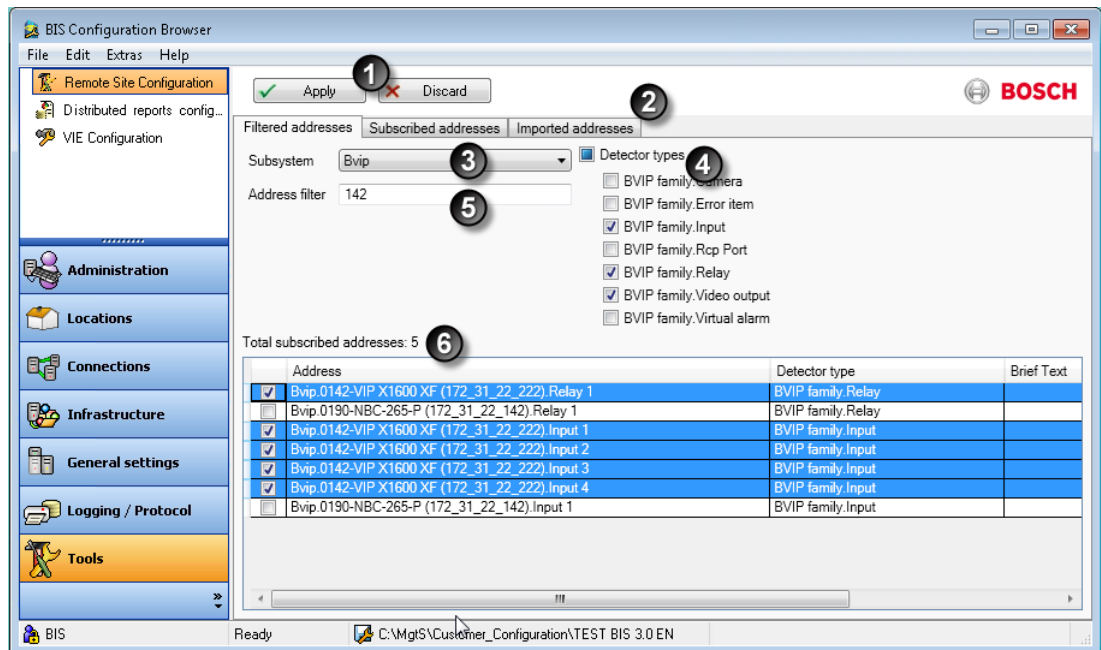

Label	Description
1	Apply button prompts for the name of a (.expcrip) file in which to store the Provider server's configuration.

Label	Description
2	Three tabs: Filtered addresses tab: For filtering and selecting those addresses that will be included in the configuration file Subscribed addresses tab: For displaying those addresses that have been selected for inclusion in to the configuration file Imported addresses tab: For reading addresses from existing configuration files and adding them to the Subscribed addresses tab
3	Drop-down list for selecting the subsystems of interest
4	Check boxes for selecting the detector types of interest
5	Address filter to further refine the current list of addresses
6	The current list of addresses of interest, that is, the cumulative effect of (3), (4) and (5) above. When the check box of the address is selected then it appears on the Subscribed addresses tab

Creating the configuration file for the Provider server

To create the configuration file, proceed as follows:

1. Open the BIS Configuration Browser on the Provider system
2. Click Menu: **Tools > Remote Site Configuration**
Effect: The **Remote Site Configuration** dialog displays the subsystems, detector types and addresses currently configured on the Provider system.
3. Select the **Filtered addresses** tab
4. From the drop-down list select the subsystem whose addresses you wish to provide to consumer servers, or **<All>** if you wish to provide the addresses of potentially all subsystems.
5. To the right of the drop-down list, select the check boxes of any detector types you want to provide, or the superordinate **Detector types** check box if you wish to provide the addresses of potentially all detector types.
Effect: As you proceed, only those addresses belonging to both the selected subsystem and the selected detector types appear in a list in the main pane of the dialog.
Hint: If the list of addresses is still unmanageably long, it may be further reduced by entering text in the **Address filter** text box.
6. **Note:** as yet no addresses have been subscribed, that is, marked for inclusion in the configuration file.

6. Select the check boxes of the addresses in **6** that you wish to offer for subscription, that is, to include in the configuration file.

Hint: Use **Ctrl-click** to toggle the selection of noncontiguous individuals and **Shift-click** to toggle the selection of contiguous ranges of check boxes.

Effect: The selected addresses are listed on the **Subscribed addresses** tab of this dialog.

7. Click the **Apply** button **1**.
8. Enter a new filename of type `.expcrp`, or select an existing file to be overwritten.

Effect: The addresses listed in the **Subscribed addresses** tab **2** of this dialog are exported to the configuration file of type `.expcrp`.

Hint: Make a note of the location and the file name. The file is required for the configuration of Consumer systems.

Examining the final list of addresses marked for export to the configuration file

- ▶ To get a consolidated list of those addresses that will be exported to the configuration

file, select the **Subscribed addresses** tab **2**.

Note that once the **Apply** button has been clicked, and the configuration file created, then this list will be emptied. You can refill it by:

- selecting addresses using the **Filtered addresses** tab, see Creating the configuration file for the Provider server or
- reading addresses back from existing `.expcrp` files using the Imported addresses tab, see Reading and modifying existing configuration files

Reading and modifying existing configuration files

If the configuration of the Provider server changes, for example if OPC servers are added or removed, then it will be necessary to modify the contents of the existing files.

It may be useful to combine addresses from different configuration files into a new file. All this

functionality is provided on the **Imported addresses** tab **2**.

1. Click the button **Read exported addresses from file**, and locate an existing `.expcrp` file in the pop-up file explorer.

Effect: The addresses in the selected file appear as a list in the main pane of the dialog.

Note: if any of the addresses in the `.expcrp` file are no longer configured on the Provider server, then they will be marked **Not Found** in the **Remark** column, and then ignored.
2. Click the button **Subscribe addresses**

Effect: selected addresses are listed on the **Subscribed addresses** tab of this dialog
3. If desired, add further addresses to the **Subscribed addresses** tab by using the filters on the **Filtered addresses** tab. See Creating the configuration file for the Provider server for details.
4. Click the **Apply** button
5. Enter a new filename of type `.expcrp`, or select an existing file to be overwritten.

Effect: The addresses listed in the **Subscribed addresses** tab of this dialog are exported to the configuration file of type `.expcrp`.

Hint: Make a note of the location and the file name. The file is required for the configuration of Consumer systems.

10.2 Consuming information from other BIS single server systems

For a BIS single server system to become a consumer server, that is to be able to see and process information from a remote BIS single server system, also known as a Provider server. It is of course necessary that there be a network connection between them.

Secondly you must include the remote system in your configuration. To do this, proceed as follows:

- **Prerequisites:** You will need:
 - the IP address or network name of the Provider server,
 - network access to the configuration file for that Provider server
 - the name and password of an operator on the Provider server who has access to the desired information (e.g. with administrator rights)
- 1. Open the BIS Configuration Browser on the intended Consumer system
- 2. Click Menu: **Connections**
- 3. Right-click the local machine in the list of connection servers and select **Add Subsystem** from the context menu. (Alternatively, left-click the desired server and click the  button to add a subsystem to that server)

Effect: The **Select new subsystem** dialog appears.
- 4. From the list add a subsystem of type Remote Sites Connector , edit the suggested subsystem name if desired, and click the **OK** button.

Effect: The Remote Sites OPC server appears below the consumer server as one of its subsystems.
- 5. Right-click the new Remote Sites OPC server in the list and select **Properties**. (Alternatively, left-click the desired server and click the  button to invoke the **Subsystem properties** dialog.)
- 6. Click the **Launch** button to start the external configuration program.

Effect: The **Configuration of Remote Sites Connector** dialog appears.

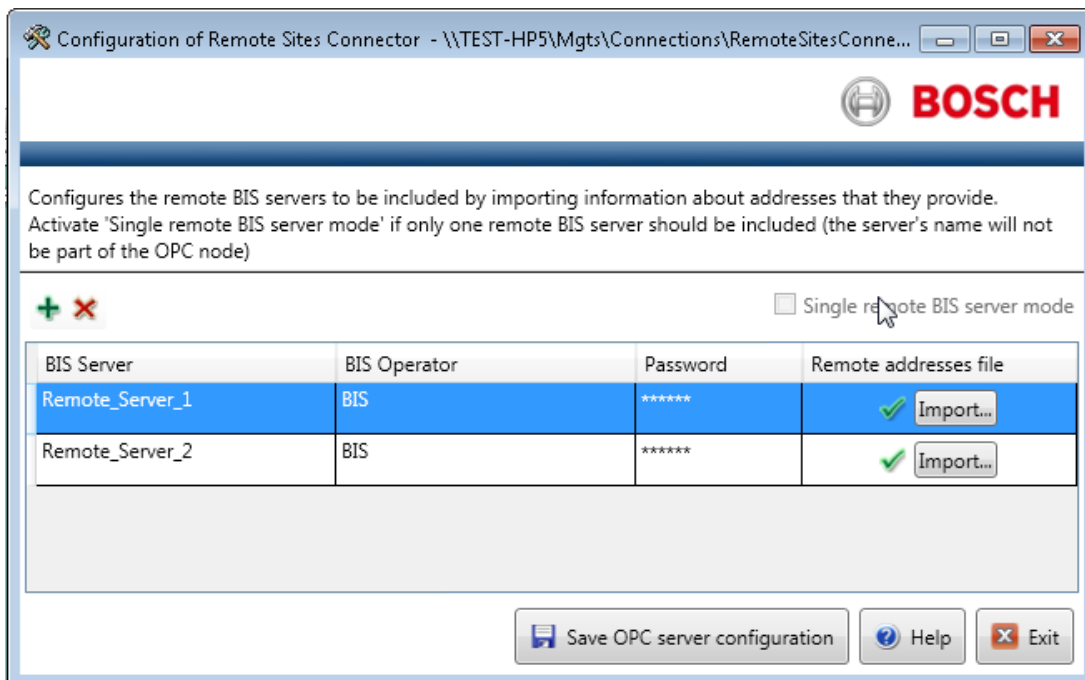

7. Click the  button to add a BIS Provider server to the list.
Note: If no more than one BIS Provider server is to be added select the check box **Single remote BIS server mode**.
8. Enter the name of the Provider server or its IP address under column **BIS Server**. Enter the name of an operator (on the Provider server) under **User**, and that operator's password under **Password**.
9. Click the **Import...** button under column **Remote Addresses File** and navigate to the encrypted configuration file that you created on the Provider server (see *Providing information to other BIS single server systems*, page 92).
10. Click the **Save OPC server configuration** button.
Effect: The current configuration is saved with the selected Provider server as one of its OPC servers.
11. Click the **Exit** button to exit the dialog.
12. Use the standard browsing procedure as described in *Creating connections and addresses by browsing*, page 136 to map the Provider server's information into the current configuration of this Consumer server.

See also

- *Creating connections and addresses by browsing*, page 136
- *Providing information to other BIS single server systems*, page 92

10.3 Current limitations

There are currently some limitations regarding alarm processing on multi-server BIS systems.

Functionality

- Any system information in an Action plan coming from a Provider server relates only to the Provider server.

- Only Action plans defined on the Provider server for a particular address will display on the Consumer system (server or clients). Action plans defined on the Consumer system for the same address (which is a remote address for the Consumer) will not display, even if the Provider server has no Action plan of its own.
- If an alarm is processed on a Provider server its Action plan links will only appear in the Provider’s event log. If processed on the Consumer server the links appear in both event logs.
- Video controls in the Action plan of a remote message are not supported.
- Miscellaneous documents for alarms on Provider addresses will not be displayed on Consumer clients, that is, the Provider does not forward Miscellaneous documents.

Interoperability

- Multi-server BIS systems can only operate within a single time zone.
- BIS 4.1 and BIS 4.0 systems can not be mixed within a Multi-server BIS system. Bosch recommends using the latest version wherever possible.
- In order to process a message on a consumer system, the operator on the Consumer system must have the same or more authorizations than the originator on the Provider system.

Quantitative limitations

Max. number of levels in a multi-server BIS hierarchy	2
Max number of Consumer servers per Provider server	1
Max. number of Provider servers per Consumer server	64
Maximum number of Provider servers per Remote Sites Connector	4
Max number of Remote Sites Connectors per Connection server below a Consumer server	4
Max. number of addresses per Remote Sites Connector	10,000
Max. number of alarms per second from Provider to Consumer server	20

10.4 Upgrading a BIS 4.0 multi-server system



Notice!

Multi-Server BIS and customized WCF configurations

If you have made manual changes to the WCF configuration file:

`\MgtS\Platform\BisClientProxyWcfServer\BisClientProxyWcfServer.exe.config`

in BIS 4.0, these will also be migrated to BIS 4.1 and newer versions. Before customizing this

file refer to the specialist documentation in `\MgtS\Platform\WCF Configuration.pdf`

11 Optional BIS configuration tools

BIS provides the following optional tools for the following tasks:

- **NetLimiter**: for limiting the network bandwidth used by BIS
- **ClientInfo**: for checking detailed information about a BIS client PC.
- **ChangePassword**: for propagating a password change for user MgtS-Service (i.e. the user under which all BIS subsystems run) to all the subsystems on that server. **Note**: the ChangePassword tool needs to be executed separately on each connection server, unless MgtS-Service is defined as a domain user.
- **Microsoft SQL Server 2008 Report Builder 2.0**: for creating and modifying SQL Server reports for the BIS Event Log.
- **.NET Framework 2.0** : for running applications designed to target the .NET Framework 2.0.

These tools may be installed from the internal page http://<Your_BIS_Server_Name>/clientdeploy/tools.aspx . More details on installation can be found in the BIS installation guide.

11.1 NetLimiter Tool

Perform the following procedure to limit the network transmission speed between the BIS server and the client PC:

1. Install the NetLimiter tool on the client PC - See Client Configuration Tools.
2. On the BIS server, open the Configuration Browser's **Administration** tab, then select **Server structure**.

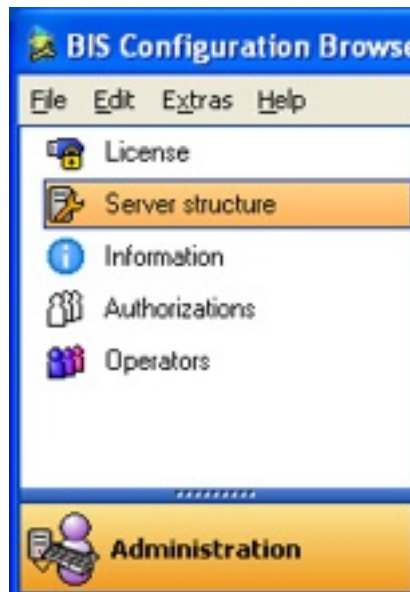

3. On the bottom of the window, enable **Limit used bandwidth**, then select the transmission speed from the drop-down menu.

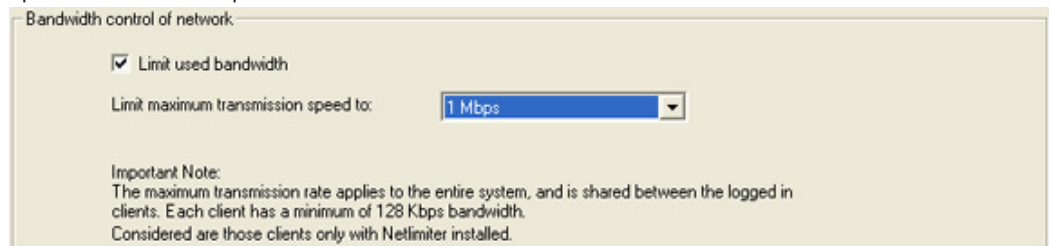



Notice!

The bandwidth limiting function will only work for client PCs with the NetLimiter tool installed.

11.2

ClientInfo Tool

Perform the following procedure to view client PC configuration information:

1. Install the ClientInfo tool on the client PC - see above.
2. The ClientInfo window opens, providing information about the client PC configuration.

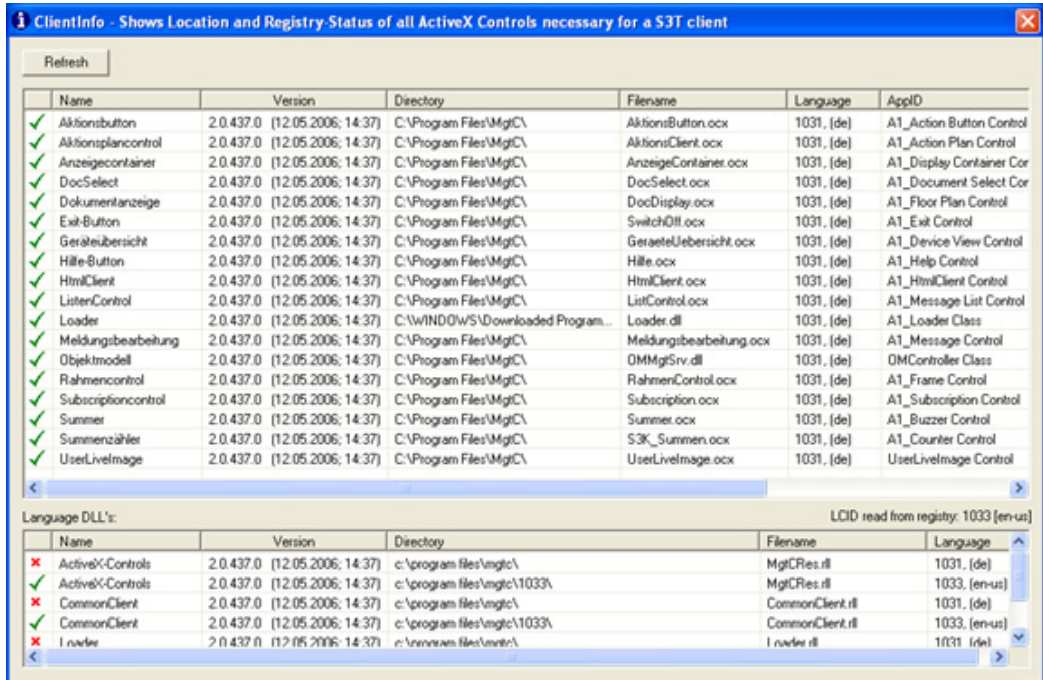

3. Click **Refresh** to update the configuration information displayed in the window.

11.3

Using the ChangePassword tool

Purpose and scope

The **ChangePassword** tool is used by system administrators to maintain the passwords of BIS system users, that is both Windows operating system (OS) and SQL users.

Examples of system users are:

- Mgt-service (OS user)
- Mgt-SSRS-Viewer (OS user)
- Event log query (SQL user)
- Event log writer (SQL user)
- Security engine query (SQL user)
- Security engine writer (SQL user)

This tool replaces the **ChangePassword** tool which was formerly downloaded from client tools, and the **SSRS Password Reset** tool present in installer folder.

Hence those two tools are no longer available

Products concerned

Building Integration System (BIS) versions 4.6 and later

Intended audience

- Security manager
- Software configurer
- Software administrator

Usage scenarios

Configuration

Prerequisites

The BIS system has been successfully installed.

Procedure

1. Execute `ChangePasswordTool.exe` from the folder `<BIS installation folder>\Mgts\Tools\ChangePassword\`
2. A welcome screen explains the purpose of the tool. Click **Next >**
3. On the second screen, from the drop-down list **Select the user account to change**, select the account that you wish to modify
4. In the text box **New password**, type the desired password
5. In the text box **Verification**, type the desired password again to confirm it

If you are modifying a Windows OS account, or an SQL account with Windows authentication, simply click **Set Password**.

If you are modifying an SQL account that requires SQL server authentication, proceed as follows:

1. Select the option button **SQL server authentication**
2. Enter the SQL server **Login** and **Password** in the text boxes provided
3. Click **Set Password**

Results for MgtS-Service

If you changed the password for **MgtS-Service**:

1. The tool displays a list of the Windows services that are affected.
 - Click **Cancel** to abort the changes or **Apply** to confirm them.
2. Proceed with the tool as described in the next section

Results for other passwords

If you changed a password other than that of **MgtS-Service**:

- The tool confirms whether the requested password change has been successful.
 - Click **< Back** to return to the second screen and set any other passwords that you require.
 - Click **X Exit** to close the program.

The passwords of SQL users are stored and become effective immediately.

The passwords of Windows users become effective only after a reboot.

Important additional information

- Do not change BIS user passwords without this tool. Serious malfunctions would result.
- Do not delete the file `DbUserInfo.crp` file. Serious malfunctions would result.

NOTE: If the file has been accidentally deleted, use the tool to create the **Mgts-SSRS-Viewer** password, and then create all the other SQL users' passwords with the tool.

- If a remote SQL instance is used, then the tool will update both local machine and also the remote SQL machine, prompting for the remote admin username and password if required.
- If SQL reports and SQL event log instances are on two different remote machines, then ensure that both machines have same Windows admin username and password.
- A password that has been changed on a remote SQL instance machine will only come into effect after the SQL service has been restarted on the remote instance.

- If connection servers are used, run the tool on each connection server separately, in order to ensure the same **Mgts-Service** password throughout.
- Similarly if a multi-server BIS environment is used, run the tool on both the machines (provider and consumer) separately, in order to ensure the same **Mgts-Service** password throughout.

11.4 Microsoft SQL Server Report Builder 3.0

This is a Microsoft tool with its own online help. A white paper is available from Bosch Security Systems describing in detail how to modify a report for display in the BIS Event Log. Please contact Bosch ST technical support for this white paper.

11.5 .NET Framework 2.0

The installation of BIS automatically includes .NET Framework 2.0 on the BIS server, but not on BIS clients, which are typically installed asynchronously. Each BIS client requires .NET Framework 2.0, and so the Framework is always available for installation from the internal page: http://<Your_BIS_Server_Name>/clientdeploy/tools.aspx .

12 BIS Manager tabs

12.1 The BIS Manager

Use the BIS Manager to configure and operate the various server functions, and to query system statuses. This is done using the following tabs:

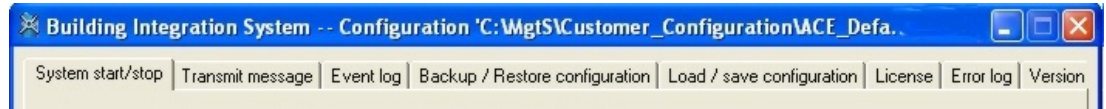

- The System Start/Stop tab, page 103
- The Transmit Message tab, page 105
- The Event log tab, page 105
-
- Event log Administrator Settings, page 110
- The Backup/Restore Configuration tab, page 112
- The Load-Save Configuration tab, page 113
- The License tab, page 113
- The Error Log tab, page 113
- The Version tab, page 114

12.2 The System Start/Stop tab

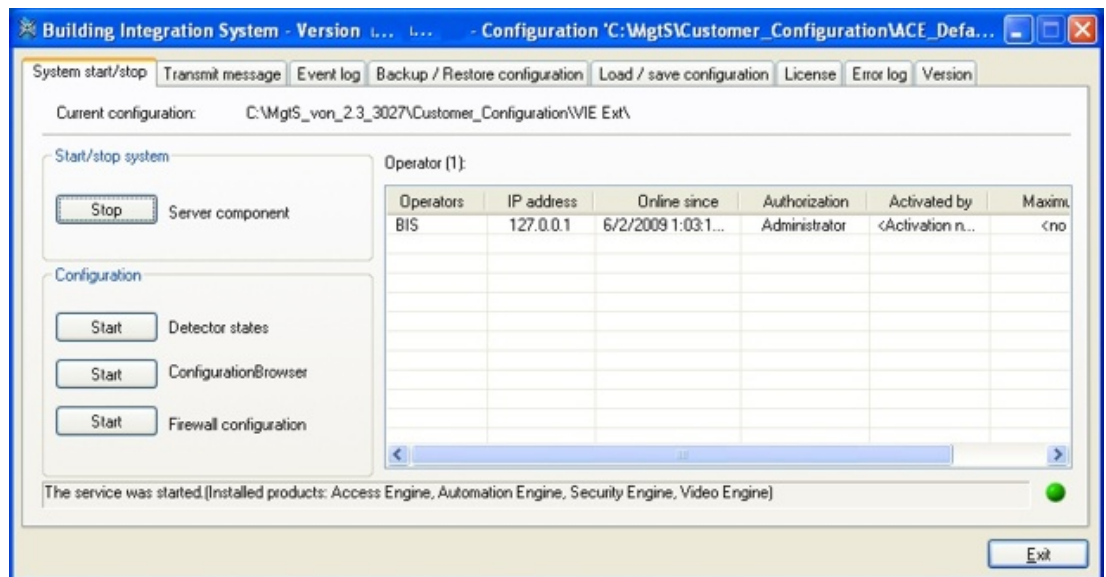

The Start/Stop system pane

The left side of this tab contains buttons for starting and stopping the BIS server and configuration tools (primarily the configuration browser. The right hand side of the tab shows a list of the operators currently logged in, or during startup or shutdown, a list of running, starting or stopping processes.

- If the BIS server is currently running, the button is labelled **Stop** Server component– Click here to shut down the BIS server. The right hand pane shows the progress of the shutdown, process by process. When the server software stops, all operators are automatically logged out. Use the **Transmit message** tab to send a message to all logged-in operators, informing them of the planned shutdown.

- If the BIS server is currently stopped, the button is labelled **Start** Server component— Click here to start the BIS server manually. The right hand pane shows the progress of the startup, process by process. The startup is complete when the round control LED in the bottom right corner of the window shows green **and** your operator name appears in the user list.

Operator list

When the server software is running, the manager window displays all logged-in operators with the IP address of the client PC, the operators' permission levels, and the time the operators logged onto the system.

When a logged in user has been enabled by another user (dual authorization login), the name of the authorizing user appears in the “Activated by” column.

Operator (1):

Operators	IP address	Online since	Authorization	Activated by	Maximum bandwidth
BIS	127.0.0.1	12/2/2009 8:40:47 AM	Administrator	<Activation not nec...	<no limitation>

BIS can also be run as a Windows service (for example, in a server room with nobody logged onto the system). To configure BIS to run as a service, click **Start > Control Panel > Administrative Tools > Services**, then right click **A1_Proxy_VerWalter** and select **Properties**. Configure **Startup type** to **Automatic**.

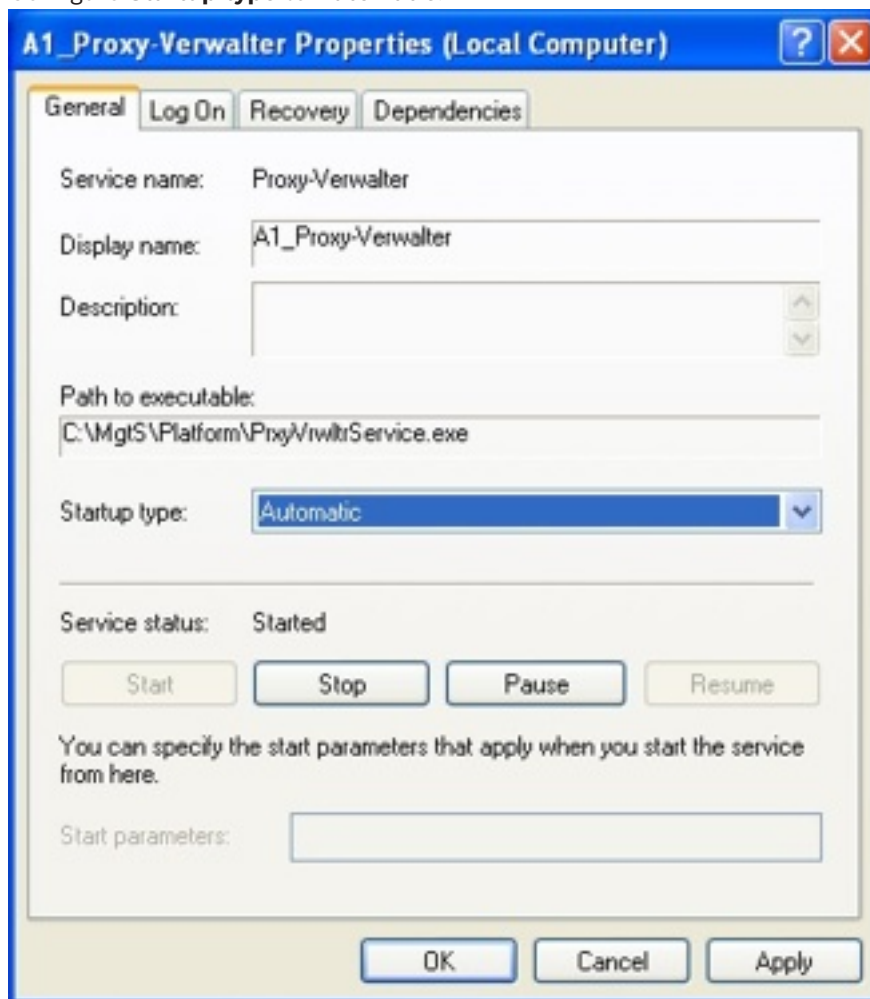

The Configuration pane

In the Configuration pane there is the following button:

- **Start** Configuration program button—Click the **Execute** Configuration program button to open the system configuration file and to access the Configuration Browser.

12.3 The Transmit Message tab

The **Transmit message** tab can be used to send a message to all logged-in users. This may become necessary, for instance, if the BIS server is to be shut down for a software upgrade and you wish to request that all users log off.

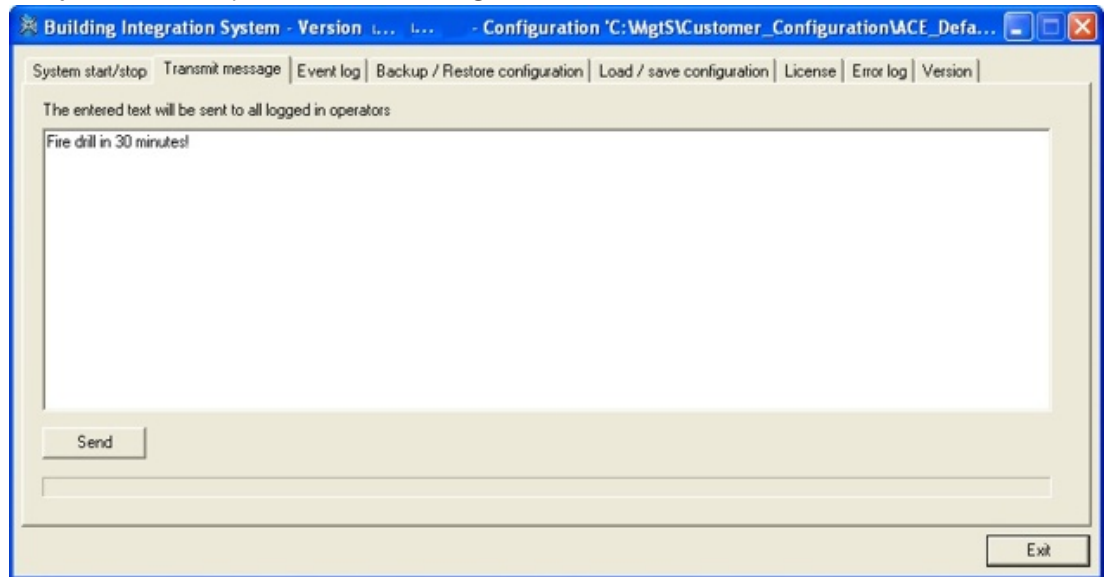

12.4 The Event log tab

Use the **Event log** tab to read and save the event log, or retrieve existing action plans (which are logged together with the message in the event log).

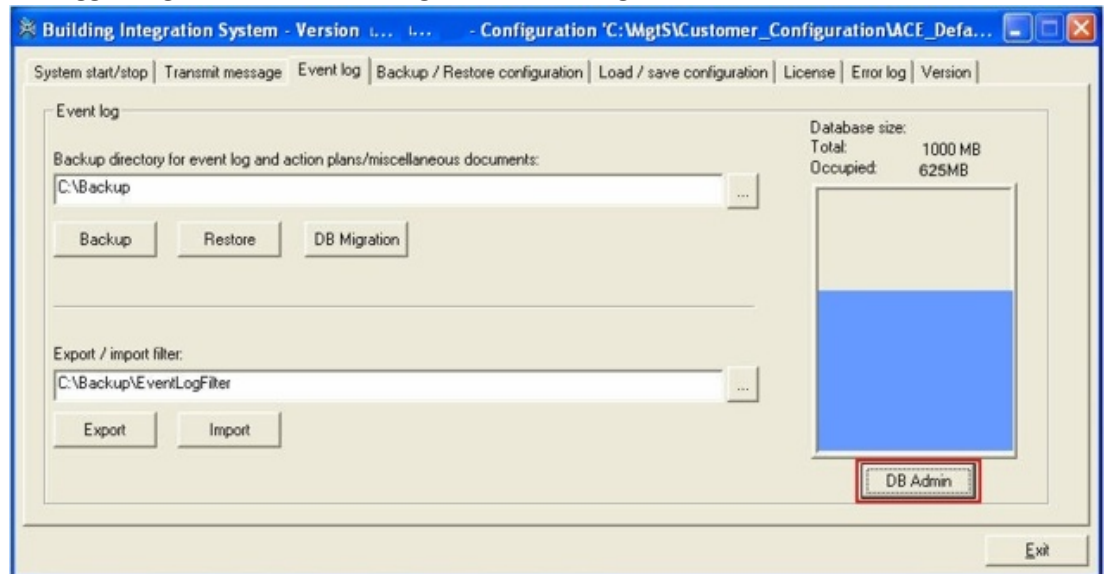

Display Event log Size

The Event log's size and capacity used are displayed in a graphic. As of BIS version 3.0 the maximum size of the Event log database is 60 GB. Administrator rights are necessary to change any settings.



Notice!

Allocating space to the Event log

Reducing the size of the event log in the Configuration Browser does not affect how much space is allocated on the database server. To reduce the allocated disk space of the SQL server itself, please use the Enterprise Manager or a similar tool.

Event log data deletion strategy

To ensure that the Event log is always writable it uses the following deletion strategy when nearly full:

- When 80% full a warning is generated: "Event log nearly full".
- When between 90% and 95% full the event log starts a night job at 01:00 deleting its oldest data, one day at a time, until at least 10% space has been freed.
- When 95% full a warning is generated: "Event log full". The Event log immediately begins deleting its oldest data, one day at a time, until at least 10% space has been freed.

Independently of this, every night the system deletes all entries older than the "Hold-back time" as defined in:

BIS Manager > tab: **Event log** > button: **DB Admin** > pane: **Hold-back time**.

Backing up the Event log

The backup function makes a copy of the Event log, along with action plans and other documents referenced by it.

1. In the **Backup directory for event log and action plan/miscellaneous documents** field, enter the directory in which to save the event log and action plans. For each backup, choose a uniquely named directory to avoid overwriting an existing event log.
2. Click the **Backup** button.
A popup dialog asks whether the saved data should be removed from the current event log.
 - Click **No** to save event data to a file in the specified directory.
 - Click **Yes** to save the event data as above, but additionally to remove the saved events from the current event log.



Notice!

Data removed and retained in the current Event log by the backup.

Backup with data removal deletes all events from the current event log. Structural information related to the events is nevertheless retained, so that the system can continue to use them.

Automatic Backup of the Event log

BIS can backup the event log automatically as scheduled by the BIS State Machine.

See *Example of automatic backup of the event log using Associations*, page 183

Restoring the Event log

1. In the line **Backup directory for event log and action plan/miscellaneous documents** field, click the [...] (file selector) button, then select the directory containing the desired event log backup.

2. Click **Restore**. The selected event log is written to a predefined restore directory. This directory contains only the last event log retrieved with **Restore**.



Notice!

The action plans and other documents contained in the event log are retrieved by the Restore function. The restore process does not affect the event log currently in use.

Display the Restored Event log

Specify the retrieved event log instead of the current event log as the target of the event log request.

12.4.1

Updating the Event log database (Database migration)

The **DB Migration** function enables the user to convert event log backup files from previous versions to the current database structure.

Notice!

SQL Server migration caveats

The DB Migration tool can be invoked only from the BIS server for databases on that server. To migrate databases on remote database servers, please use the SQL Server administration tools.

It converts only from an earlier SQL Server version to the current SQL Server format, not to any interim version.

It converts only one backup file at a time.

SQL Server 2012 (in BIS 3.0) no longer provides migration support for SQL Server 2000. If a migration from SQL Server 2000 is required for BIS 3.0 and above, please migrate in 2 steps, e.g. via SQL Server 2008 (BIS 2.5).



Invoking the DB Migration tool (Event log upgrade wizard)

1. Click the Event log tab in the BIS Manager
2. Click the **DB Migration** button.

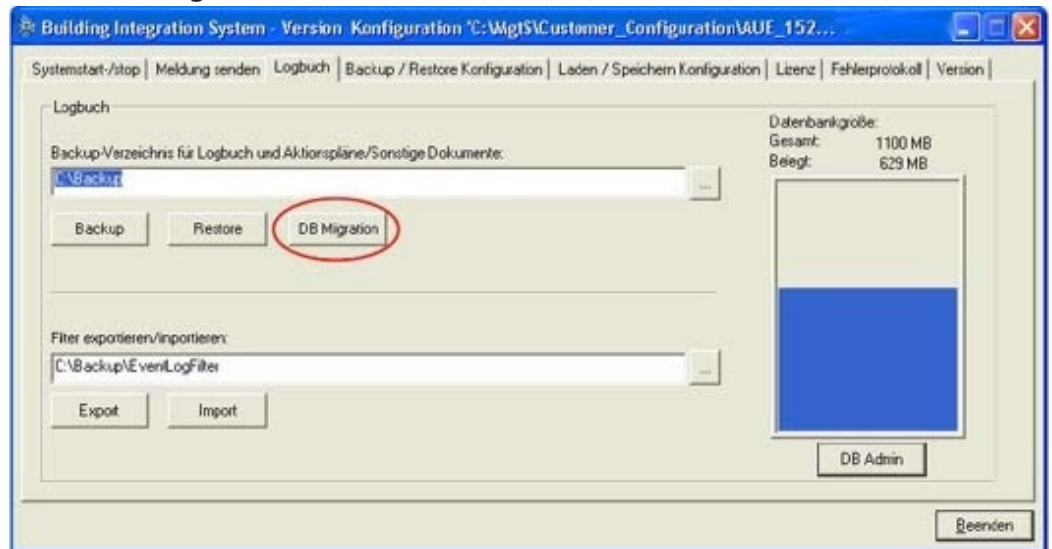

- The first page gives the BIS version and a short introduction to the capability of the tool. Click **Next**.

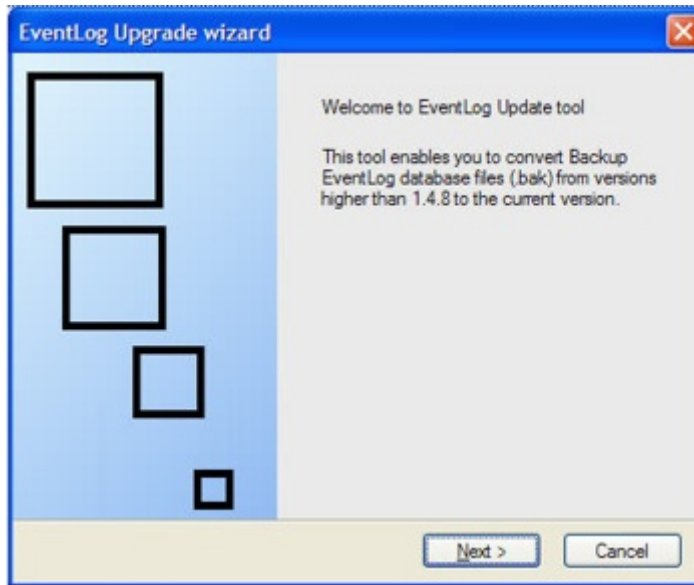

Select source and destination files

Changes can be authorized via an SQL Server username and password, e.g. those of the 'sa' user, or via Windows authentication - provided the Windows user currently logged-on has sufficient rights on the SQL Server.

- Click the ellipsis button “...” in the section labeled **Source backup file** to select the source file.
 - Click the ellipsis button “...” in the section labeled **Destination backup file** to select the destination file.
- NOTE** The wizard allows you to save to both local and mapped network drives.
- Click **Next**.

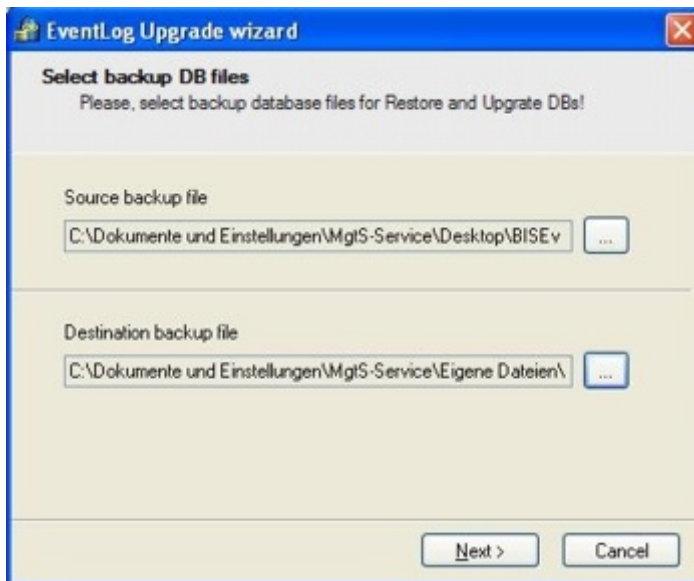

NOTE. The wizard gives an error message if it finds the wrong format. Click **OK** to select a different source file.

Progress display

- ▶ The next page shows the steps involved in the DB migration. Click **Start** to continue.

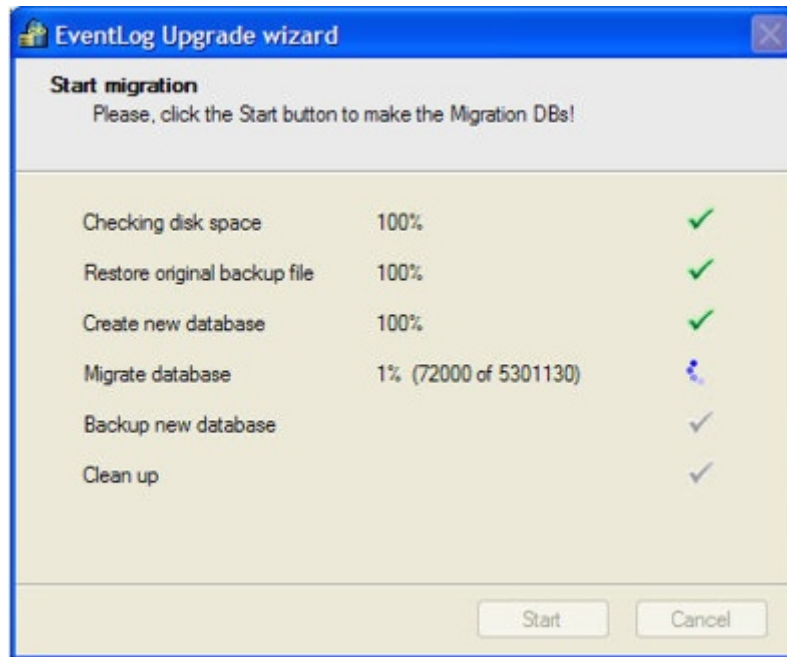

The following steps are performed:

- Checking the space on the current disk drive (min. 10 GB)
- Copying the backup file (.bak) to the local drive (in the case of network drives copying first to a TEMP directory)
- Creating a new Event log database with the new structure
- Transferring the data
- Upgrading the data to the current DB Version (i.e. that of the BIS-Setup)
- Backing up the new database
- Copying the backup file to back to the network drive (if applicable)
- Deleting all temporary and superfluous files and directories

Results display

After a successful migration the wizard displays the following:

- The number of data records transferred
- The number of warnings during the transfer
- The execution time

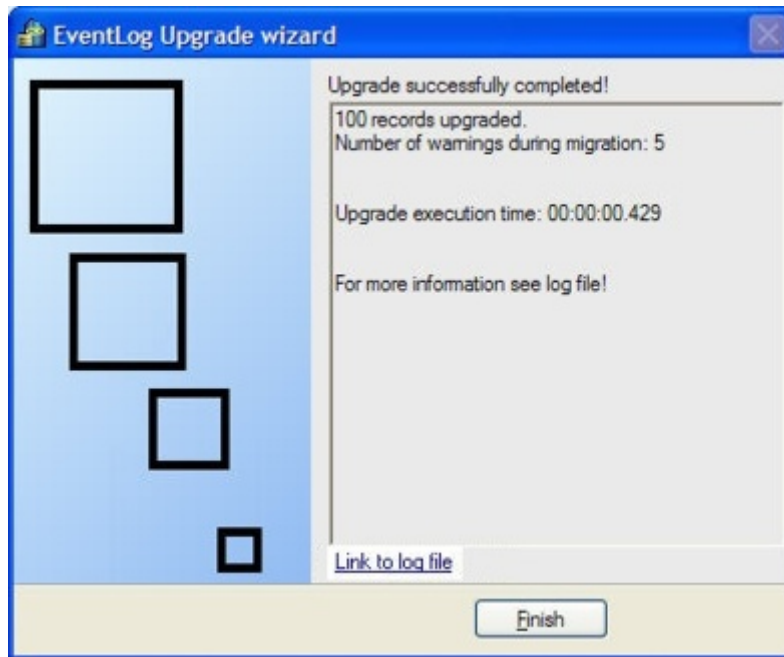

More information can be found in the log file of the upgrade wizard. To view this click the link **Link to log file**

Exporting/importing Event log filters

1. Enter a destination directory in the **Export/Import filter** text box in which to save a pre-defined event log filter, or the source directory for filters you wish to import.
2. Click **Export** or **Import** and confirm.

12.4.2

Event log Administrator Settings

On the **Event log** tab, click the button **DB Admin** (below the database size graphic) to change database settings.

Changes can be authorized via an SQL Server username and password, e.g. those of the database administrator user, or via Windows authentication - provided the Windows user currently logged-on has sufficient rights on the SQL Server.



Notice!

You must stop BIS before you can change database settings.

Database name and access path

Click the **Modify...** button next to the text field marked **Event log database directory:**

Enter the new path and filename and confirm to change the location of the database. To back up the event log to a network drive from the BIS login server, the **MgtS-service** account must have read/write access to that drive and directory

Database size

- Check the size of the database regularly from a client or server workstation.
- Back up the event log before the configured size limit is reached and records are lost.
- The database capacity can be increased and reduced using this feature. Shrinking the database size is only possible to the current size minus 10%.
- Regardless of whether the user is increasing or reducing the size, they should always check whether the action completed successfully.

Enter the new database size in the text box. The following restrictions apply:

- If MSDE is used then the maximum size that can be entered is 2 GB.
- If an Express Edition **below** 2008 R2 is used, then the maximum size is 4 GB.
- If an Express Edition of 2008 R2 or above is used, then the maximum size is 10 GB.
- Only if a full SQL server is used can the size be increased above 10 GB.

Confirm your input with the **OK** button at the bottom of the dialog.

Password

Changing the system administrator username and/or password

Note: As of BIS 4.6 the database administrator user need not have the username `sa`. The database username of any suitably authorized user is acceptable.

Procedure

1. In the **Password** pane click the **Modify...** button.
2. Enter the administrator username whose password you wish to change.

3. Enter the old password, the new password, and the new password again to confirm.
4. Click **OK** to save.

Hold-back time (data retention time)

Define here for how long data should be retained in the Event log. The period can be set in days, weeks or months.

1. Days

The default period is 30 days. The possible range is 1 to 3650 days. In default case data older than 30 days will be deleted on the 31st day.

2. Weeks

The default period is 12 weeks. The possible range is 1 to 530 weeks. Thereafter data older than the defined period is deleted on the weekday selected, once per week.

3. Months

The default period is 120 months. The possible range is 1 to 120 months. Thereafter data older than the defined period is deleted on the first day of the following month

Click **OK** to confirm your changes.

12.5

The Backup/Restore Configuration tab

Use the **Backup/Restore Configuration** tab to backup or restore the configuration of the system or the configuration of the installed products (for example, the Security Engine's DB9000 database).

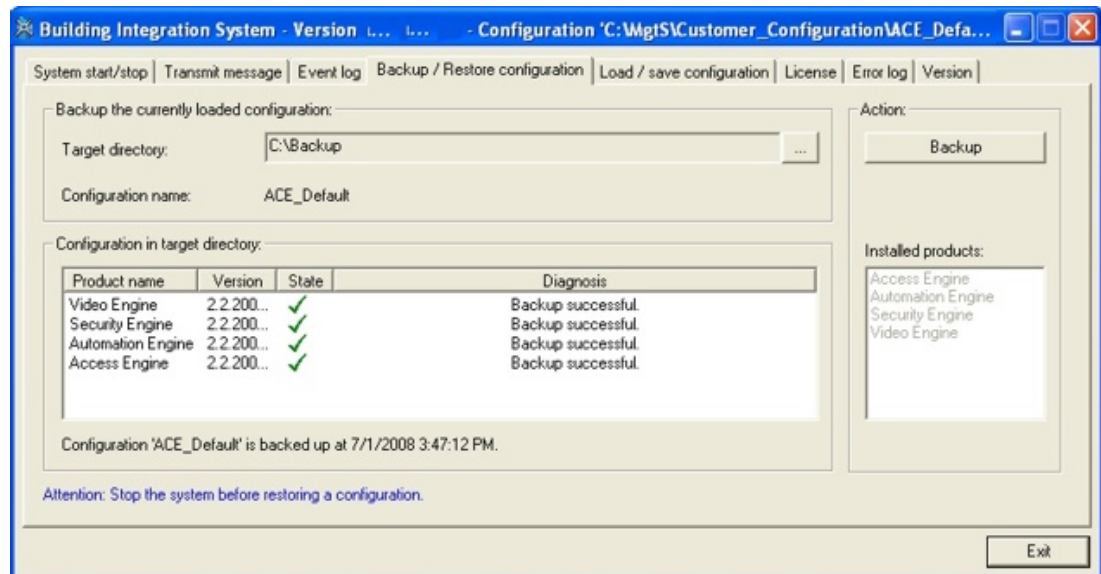

1. In the **Target Directory** field, click the “...” button to select a local or remote directory in which to store the backup.
2. Click the **Backup** button (shown if the system is running) to initiate the backup of the components.
3. Click the **Restore** button (shown if the system is not running) to initiate the restore of the configuration.



Notice!

The **Backup** button changes its label to **Restore** when the server component has been stopped from the **System start/stop** tab.

12.6 The Load-Save Configuration tab

The **Load/save configuration** tab allows you to load any configuration or save the current configuration.

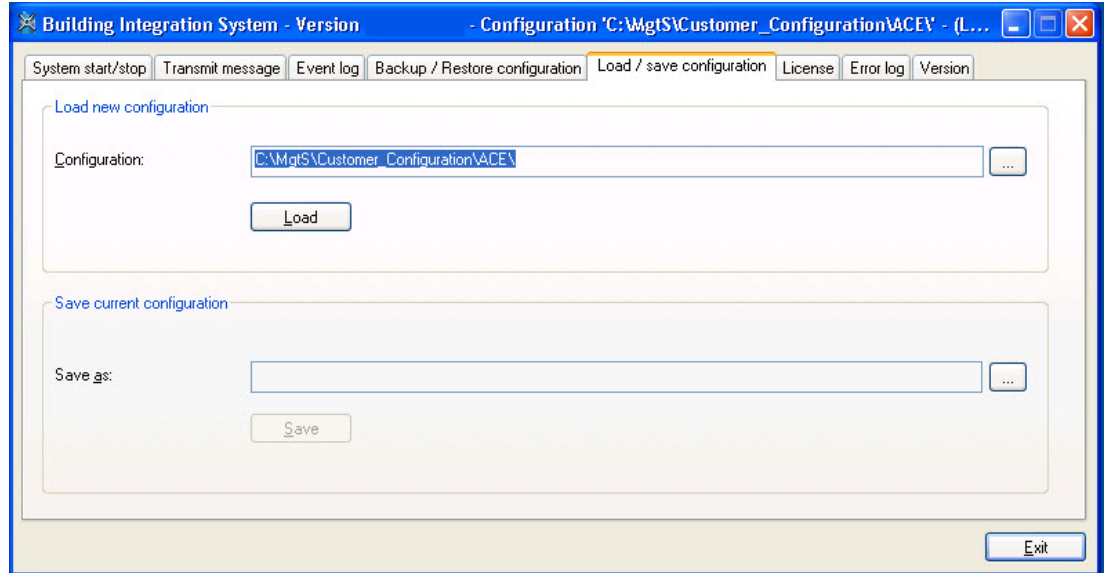

12.7 The License tab

The **License** tab allows you to view in detail the licenses held by the BIS server. See *License*, page 115 for information on enabling new BIS features by importing a different license file in the Configuration Browser.

See also

- *License*, page 115

12.8 The Error Log tab

The **Error log** tab displays the error file (Error*.log), and is updated whenever changes occur.

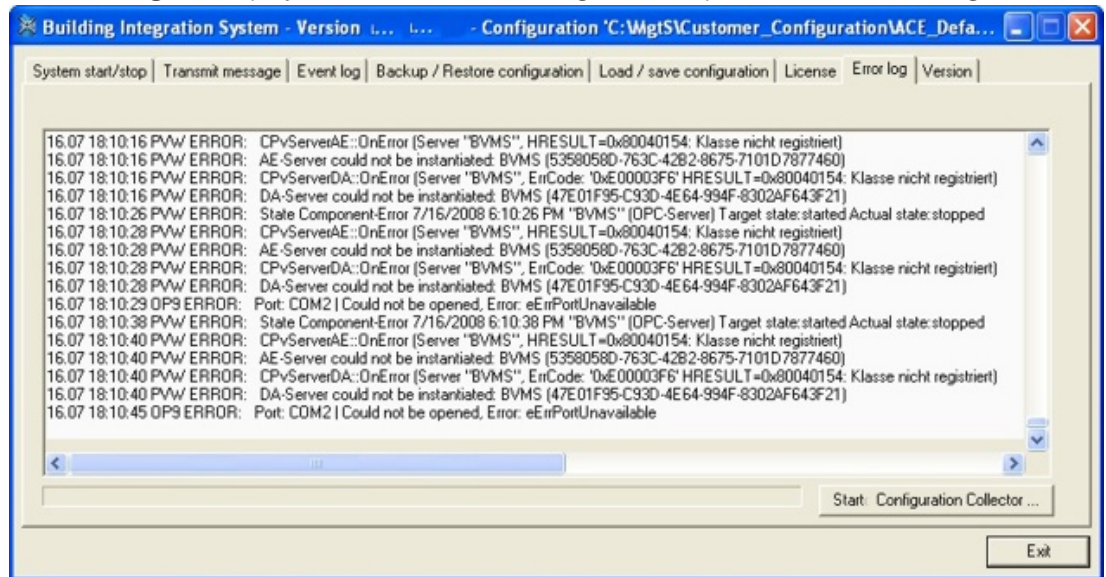

Click the **Start Configuration Collector** button to launch a tool which guides you through collecting configuration information into a ZIP file. This ZIP file can then be sent to Bosch Technical Support for troubleshooting.

The **Configuration Collector** tool has its own online help, which can be invoked from any of its tabs.

BIS stores the **Error*.log** file in the **C:\S3K_Logging\Error**.

12.9

The Version tab

The **Version** tab provides details about:

- The version of BIS that is installed
- The installed engines

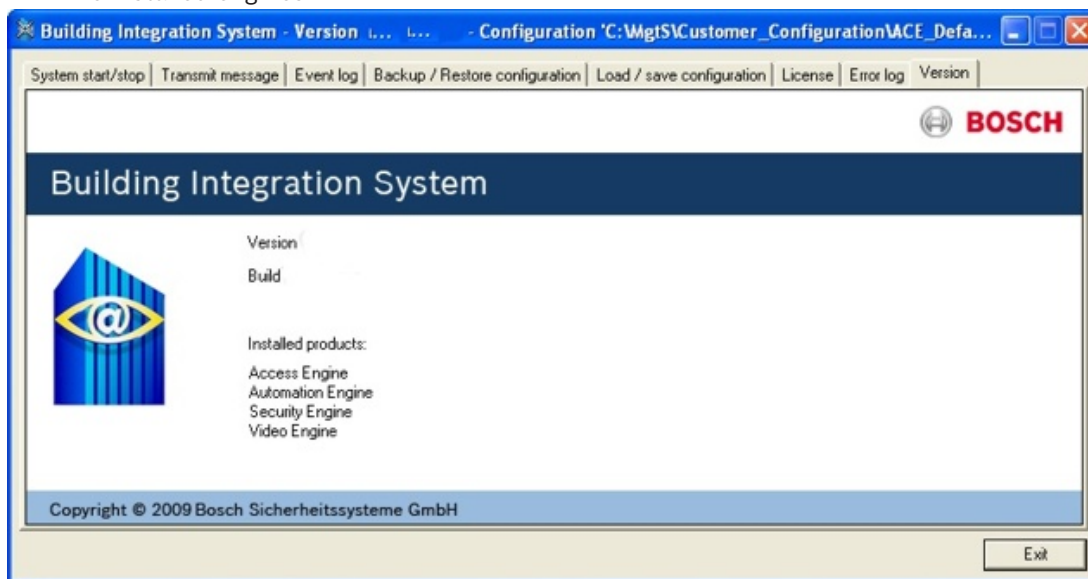

13 Configuration Browser tabs

13.1 License

The License dialog

From the Configuration Browser, click the **Administration** Outlook button, then select the **License** dialog.

This dialog shows a list of what BIS features are currently licensed for the current configuration.

Activating licenses for a configuration

Prerequisite: You have activated the licenses for the BIS server that you are using. See *Licensing the BIS server, page 25* for the procedure to update licenses for the BIS server computer, using the BIS manager.

1. Open the configuration you wish to modify in the Configuration Browser.
2. Click the **Administration** Outlook button then select the **License** dialog.
3. Click the **Read** button to refresh the main dialog pane and import the server's activated licenses into the current configuration.
4. Load or reload the current configuration if you wish the new licenses to take immediate effect. See *Opening (loading), saving and copying configurations, page 35*



Notice!

Reading ACE licenses

On the **Administration** Outlook button there is a separate menu for ACE licenses, as these need to be read separately.

Demo Mode

For trial purposes it is possible to create proof-of-concept configurations in Demo mode without a license. Configurations created in Demo Mode can only be run for a limited number of hours.

Activating Demo Mode

1. From the Configuration Browser, click the **Administration** Outlook button, then select the **License** dialog.
2. Click the **Set** button next to the label **Demo mode for tests**.
3. Click **OK**.
4. To apply your settings to the configuration, click the **Apply** button. If you do not want to apply your new settings, click the **Discard** button.

Demo Mode for Access Engine (ACE)

Note that, if installed, the BIS Access Engine (ACE) uses its own form of **Demo Mode**. This can be activated for ACE configurations in the Configuration Browser by clicking **Administration > ACE Licenses > button: Activate Demo Mode**.

13.2 Server structure

From the Configuration Browser, click the **Administration** Outlook button, then select the **Server structure** dialog.

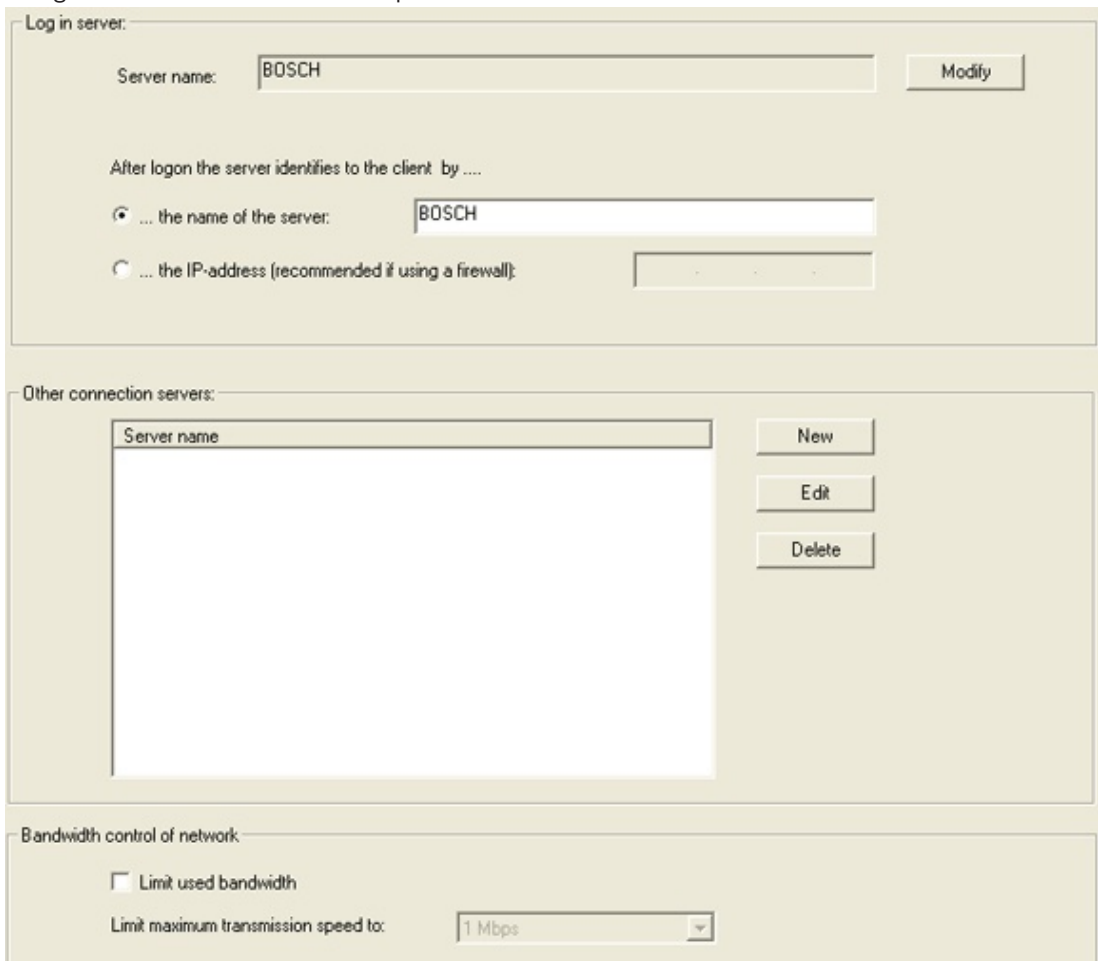

Here you inform BIS of all computers at the application and link level. The computer designations must match the computer names on the server network.

The image shows a dialog box titled 'Log in server:'. It contains a text input field for 'Server name' with the value 'BOSCH' and a 'Modify' button to its right. Below this, a label reads 'After logon the server identifies to the client by'. There are two radio button options: the first is selected and labeled '... the name of the server:' with a text input field containing 'BOSCH'; the second is labeled '... the IP-address (recommended if using a firewall):' with an empty text input field. Below the radio buttons is a section titled 'Other connection servers:' containing a table with a header 'Server name' and an empty body. To the right of the table are three buttons: 'New', 'Edit', and 'Delete'. At the bottom of the dialog is a section titled 'Bandwidth control of network:' with a checkbox labeled 'Limit used bandwidth' which is unchecked. Below the checkbox is a label 'Limit maximum transmission speed to:' followed by a dropdown menu showing '1 Mbps'.

1. Define the BIS server the computer to which the client PCs connect. Enter the name of this computer in the **Server name** field. Also choose whether the client PC can identify the BIS server from its computer name (default setting) or its IP address. If a firewall is used that prevents computer name resolution, choose ... **the IP-address (recommended if using a firewall)**.



Notice!

Localhost is not a valid server name - your system will not work correctly.

2. If you need to limit all incoming and outgoing network traffic, check the **Limit used bandwidth** check box in the **Bandwidth control of network** area and select the maximum transmission speed.

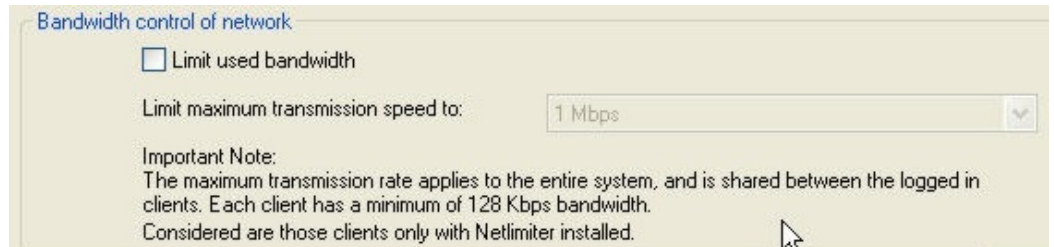

All computers have equal rights. The sequence of the listed computers does not imply a hierarchy. Insert any number of servers in the server structure, but the operator level only connects using the BIS server.

Additional connection server

Connections that are not installed on the BIS server, must also be involved in the BIS server structure. These include for example DiBos - and BVMS servers or other locally from the BIS server different connection servers.



Notice!

The registered each adding designation (**New - Server name**) must match the computer name on the server network, otherwise it will be not recognized during the subsequent browsing of the server structure..



Notice!

Make sure the compliance of user names from the BIS configuration browser and the connection servers or change the OPC security settings.

Authentication

It is possible to switch from internal BIS authentication to **Windows authentication**. In this case Windows is authenticates the login credentials of operators.

A prerequisite is that every BIS operator account must have an identically named Windows account.

Login server

Server name:

After logon the server identifies to the client by

... server name mapping to:

... the IP-address (recommended if using a firewall):

Additional connection server

Server name

Client authentication method

BIS verifies authentication Windows verifies authentication

Important:
Selection of Windows authentication makes additional steps necessary, like the exchange of the login page. Please consult the online help for more detailed information.



Notice!

Authentication is a system-wide setting, it affects all operators, not just the selected ones!

Click here for more information on: *Authentication, page 77*

13.3

Information

Select the Configuration Browser's **Administration** Outlook button, then click the **Information** dialog.

The program version and the version of the configuration data structure are shown here.

You can enter more information on the configuration or about the customer, which can also be printed out with the configuration.

Any information can be entered, such as:

- Name of the customer
- General description of the project
- Person responsible for the configuration
- Version and date of changes
- And so on

13.4

Authorizations

In the Configuration Browser select **Administration > Authorizations**.

Introduction

Authorizations are defined sets of system permissions. They are assigned to operators or Active Directory groups in the following dialogs:

Administration > Operators dialog

Administration > Active directory config

Layout of the Authorizations dialog

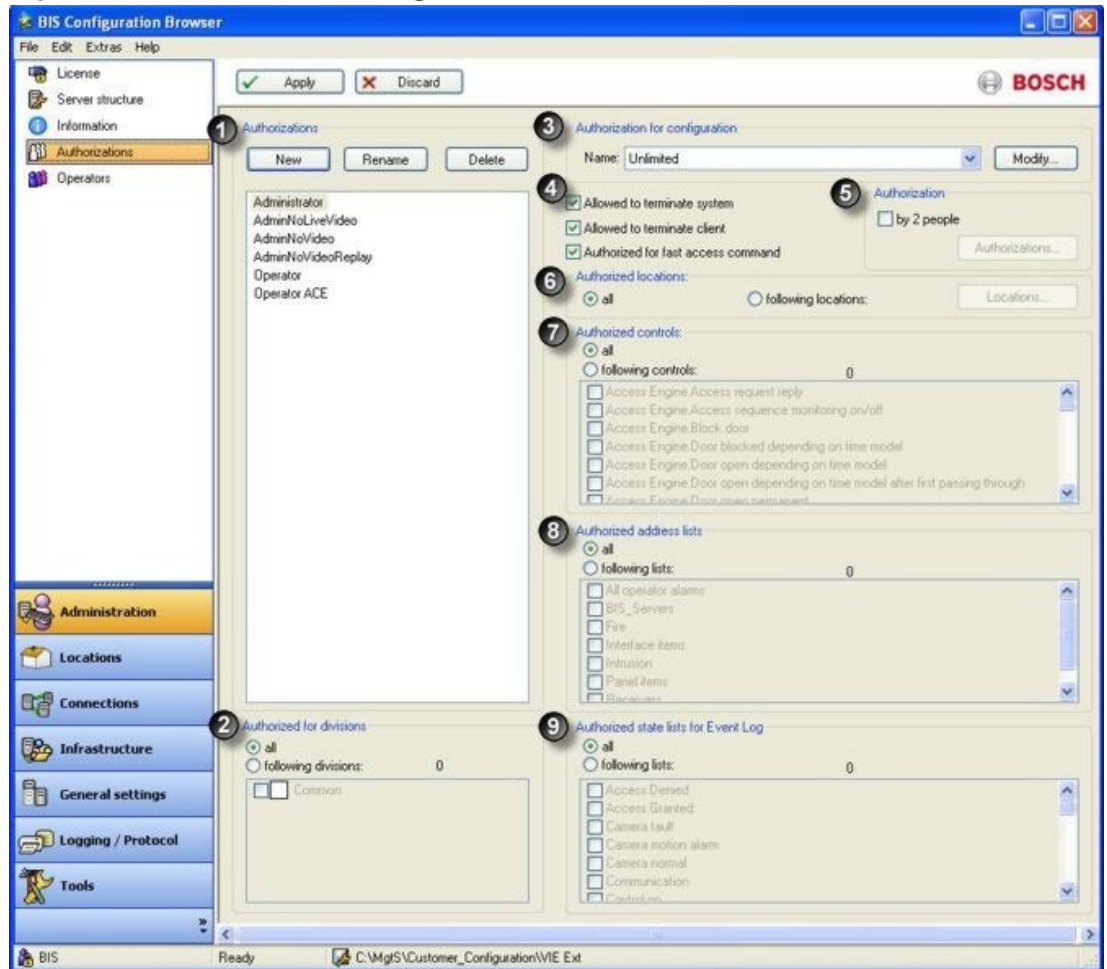

Procedure for customizing Authorizations

1. Click button **New** to create and name an Authorization 1.
2. In the main dialog select all the permissions that will be included in it. The table below explains the permissions that an Authorization may contain
3. Click the **Apply** button to save your changes.

Element	Description
<div style="display: flex; align-items: center;"> <div style="border: 1px solid black; border-radius: 50%; width: 30px; height: 30px; display: flex; align-items: center; justify-content: center; margin-right: 5px; font-weight: bold; font-size: 1.2em;">2</div> <div> <p>Authorized for divisions</p> </div> </div>	<p>Specifies whether this Authorization is restricted to certain Divisions. If a message is generated within a Division it will only be seen by operators whose Authorization contains that division. The default Division Common is always selected.</p>

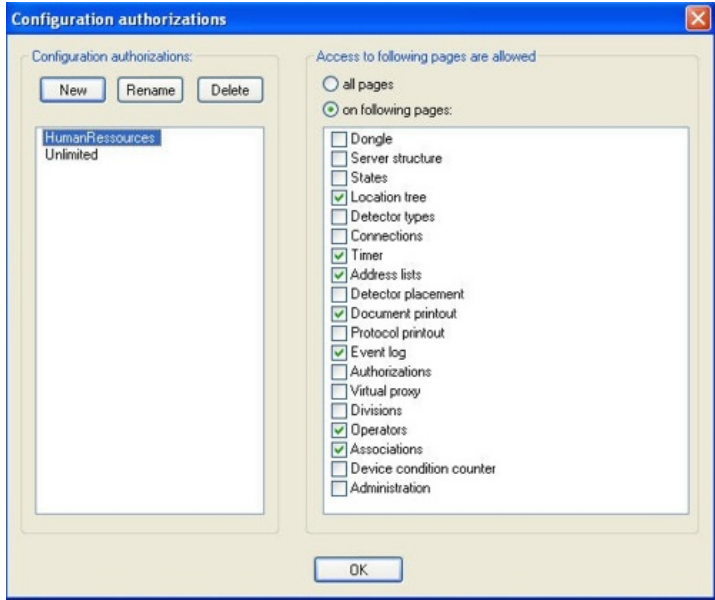
<p>3 Authorized for configuration</p>	<p>Defines which configuration pages (Outlook buttons and their dialogs in the Configuration Browser) this Authorization can access. The default value is Unlimited</p> <p>Click the Modify... button to create or edit restricted Configuration authorizations.</p> 
<p>4 Allowed to terminate system</p>	<p>Determines whether operators with this Authorization may terminate the BIS system on the BIS server using the BIS manager program.</p>
<p>Allowed to terminate client</p>	<p>Determines whether operators with this Authorization may terminate the BIS client workstation. If this permission is not granted then the BIS client does not terminate when the operator clicks the Exit (red "X") button. Instead a logon dialog appears in which the next operator but must log on before the first is logged off.</p>
<p>Authorized for fast access command</p>	<p>Selecting this check box allows users at the client PC to use fast access commands. Fast access commands respond immediately, without presenting the user with a confirmation dialog. See <i>Fast Access command, page 151</i></p>
<p>5 Authorization by 2 people</p>	<p>Specifies whether dual authorization is required (i.e whether a second operator logon is required to confirm the logon of someone with this Authorization). Click the nearby Authorizations button to select those Authorizations which can validly confirm this logon.</p> <p>Notice!</p> <p>Dual authorization applies only to BIS clients. Logging into the Configuration Browser and BIS Manager never requires more than one username/password pair.</p>
<p>6 Authorized locations</p>	<p>Defines the locations that operators with this Authorization may access. The default is all (no restriction).</p>

<p>7 Authorized controls</p>	<p>Defines the controls or commands that operators with this Authorization can execute. The default is all (no restriction).</p>
<p>8 Authorized address lists</p>	<p>Defines the addresses to which operators with this Authorization have access. This is done via Address Lists. For example, an Authorization could be restricted to receive only messages from detectors in the address list Fire.</p> <p>Note Authorizations can not be restricted to individual detector-addresses, only to address lists. If an address list is included in an Authorization, then the BIS Device overview will display every one of the list's detectors to operators with that Authorization.</p>
<p>9 Authorized state lists for EventLog</p>	<p>Defines the Event log entries to which operators with this Authorization have access. This is done via State lists.</p> <p>Note In order to prevent retroactive manipulation, entries are written along with their authorizations.</p> <p>Limitation: These settings only affect Event log searches and reports, not the visibility of states and messages in the Device overview or location plans in the BIS client.</p>

See also

- *Operators, page 124*

13.4.1 Setting Authorizations for location nodes

Introduction

The default for **Authorized locations** when defining new operators is **all**. Nevertheless for security reasons it may be desirable to allow different operators different degrees of authorization (view, modify, delete) over locations and detectors in the location tree.

By assigning restricted Authorizations to them, Operators can be prevented from receiving alarm messages or displaying location graphics from specific locations.

All operators are authorized for the nodes **Operators, Detectors without location** and **New detectors**. These check boxes are permanently selected.

Procedure

To restrict the locations for an Authorizations:

1. Select the radio button **following locations**.
A dialog appears in which the entire location tree is displayed,
2. Use the check boxes to add or remove locations from the Authorization.
 - Selecting a tree node has the initial effect of selecting all its sub-nodes.
 - Thereafter the check boxes for individual sub-nodes can be cleared and reselected.

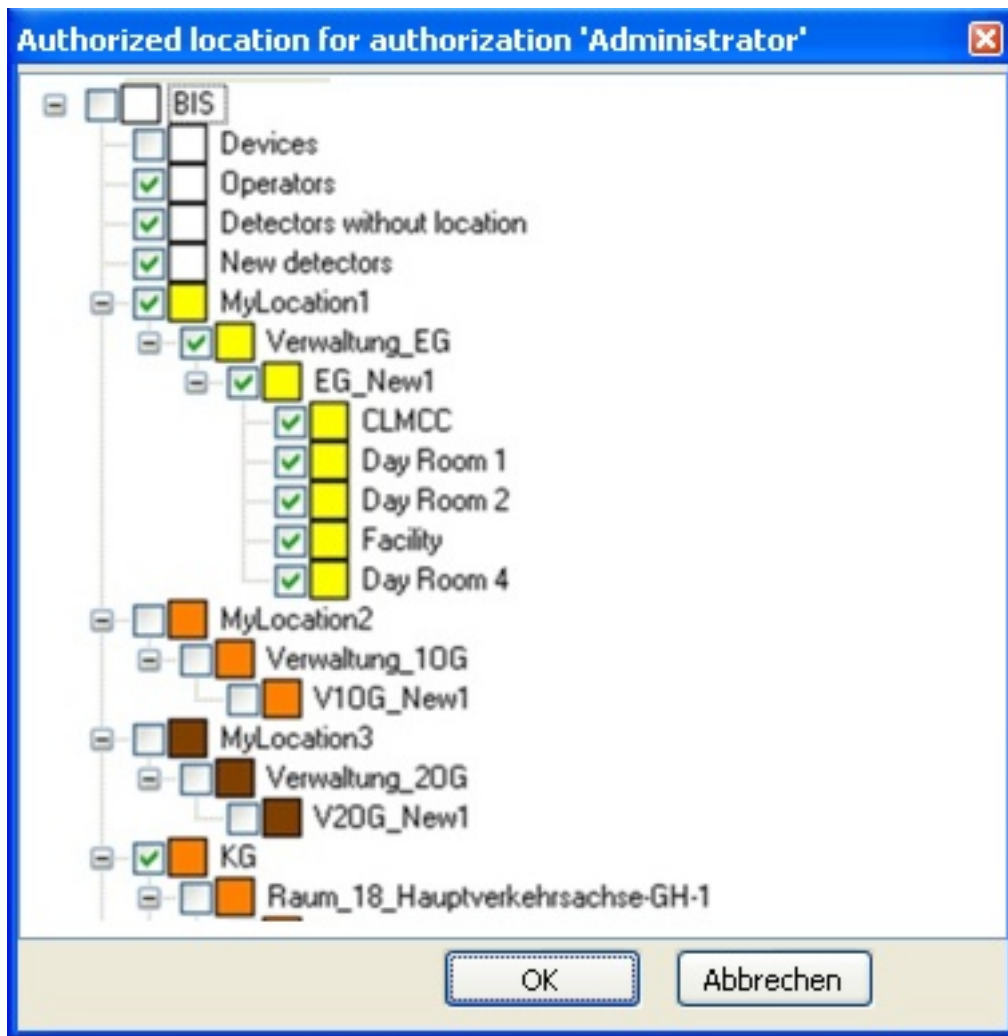

The BIS-Client displays the new assignment of authorizations in the location tree as follows:

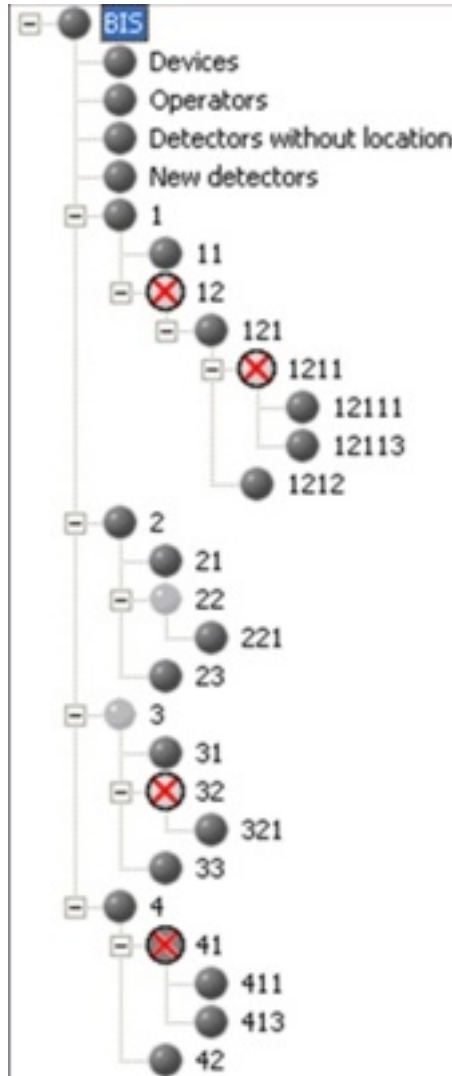

The forms and colors of the location nodes here have the following meanings:

Authorization	Appearance in location tree
Node is not authorized.	Node is not visible
Main and sub-nodes are authorized.	Nodes are dark gray
Main node is not authorized, but some sub-nodes are.	Node is light gray
Main node is authorized, but some of the sub-nodes are not	Main node is dark gray with a red cross. Unauthorized sub-nodes are not visible.
Main node is not authorized. Some of the sub-nodes are authorized and some not.	Main node is light gray with a red cross

13.5 Operators

In the Configuration Browser select **Administration > Operators**.

Introduction

On the tab General operator settings the following settings are made for each operator:

- **Operator role** (Authorization)
- **Operator profile** (customized logon pages for the BIS client)
- (Optional) **Restrict login to single workstation**



Notice!

There is no limit to the number of operators in a configuration. However, the license file can set a limit on the number of concurrent users.



Notice!

Operator names are limited to **50 characters**.

The following characters are not allowed: # < > ' " & * ? .

The password is case sensitive but the name itself is not.

Operator Role (Authorization)

Select an **Operator Role**, also known as an **Authorization**.

Only **one** Operator Role can be assigned to each operator.



For instructions to create a new customized Authorization see section *Authorizations, page 118*

Operator profile - defining operator-specific logon screens

Operators may log in from different workstations, and these may have a different screen resolutions. A Profile contains a default page plus, optionally, a list of HTML pages with different screen resolutions for different workstations.

When the operator logs on to the BIS client, BIS screen resolution of the current workstation, and displays the appropriate page.

Procedure to create an operator profile.

1. Click the **Manage...** button
The **Manage operator profiles** window appears
2. Click the  icon to add a new Profile to the list,
3. Enter a name for the Profile
4. Select a **Default page** from the file system.
5. If required, click the  icon above the table to add resolution-dependent pages
 - In the table, click the cells to set **Screen width**, **Screen height** and **Start page**
 - Logon pages are provided in the file system for various operator scenarios, including use of dual monitor.

Logon pages are stored in the directory <INST_DIR>\Customer_Configuration\MyConfig\
For more information on creating logon pages, see section: *Creating/Modifying Workstation-Specific Interfaces, page 84*

Restricting the operator to a single workstation

Restrict login to single workstation

IP Address:

IP filter:

If the new operator is to work only from a particular workstation, enter the IP address of the workstation in the text box **IP address**.

If the new operator is to work only from a particular subnet, enter an IP filter additionally in the text box **IP filter**. e.g. 255.255.0.0 where

- a value of 0 represents the parts of the address that may vary, and
- a value of 255 represents the parts of the address that must be the same as in the text box **IP address**.

In the above example, the operator can log on from any address in the subnet 192.10.*.*.

Operator Passwords

When a new operator is set up its password is the same as the operator name.

The operators themselves can change their passwords when logging on to the BIS client. For security reasons it is important to change the default password as soon as possible.

An operator with sufficient authorization can set or reset an operator password in the Configuration Browser.

1. In the Configuration Browser main window menu, click: **Extras > Change password...**
2. Enter the operator user name, old password, new password (twice).



Notice!

Access Engine operators are configured in a dedicated ACE dialog. Refer to the Access Engine Configuration online help for instructions.

13.6

Audit trail

Introduction

The **Audit trail** feature in BIS enables operators to investigate changes made to any BIS configurations on their system. It tracks both changes made in the BIS Configuration Browser, and changes made to files in the configurations' subfolders, such as miscellaneous documents, action plans, floor plans and HTML index pages. It tracks both stored configurations and the current runtime folder.

The configuration and usage of the Audit trail feature are performed in the BIS Configuration Browser. The feature is not available in the BIS client.

The following information can be retrieved from the audit trail database:

- On what configuration the change was made
- In which BIS menu and screen the change was made
- What kind of change was made
- When exactly
- By which operator
- The values of the changed fields, both before and after the change

Managing database size.

The storage space for Audit trail is limited by the database software.

- For SQL Server Express edition 2008 and below the limit is **4 GB**
- For all other versions of SQL Server the initial limit is also set at **4 GB**, but in the following cases this can be increased in the SQL Server Management software:
 - For SQL Server Express edition 2008 R2 and above the configurable limit is **10 GB**.
 - For non-Express editions of SQL Server the configurable limit depends only on the storage hardware.

To save storage space, the administrator of the system configures the retention time of the audit data, and whether the purging of outdated information should be performed automatically by the BIS system or manually by an operator.

When an Audit trail database reaches its size limit it stops trailing changes, and an error message is written to the BIS error log.

Notice!

Data security risks

Audit trail tracks changes to files in BIS configurations without regard to their contents. Use caution therefore when changing files where sensitive information, such as a password, is stored in plain text, as this information will be transferred as is to the Audit trail database.

Workarounds: Avoid altogether using applications which store passwords in plain text, or temporarily disable the Audit trail feature when making such changes.

**13.6.1****Enabling HTTPS for Audit trail (optional)**

For highly secure environments the use of HTTPS is recommended instead of the default HTTP. To configure HTTPS for audit trail, close down the BIS server and BIS Configuration Manager completely, then perform both the following tasks before restarting them:

Modify the Web.config file

1. On the BIS server, navigate to `C:\MgtS\Platform\IISRoot\AuditTrailService`
2. Rename the file `Web.config` to `Web_default.config`.
3. Rename the file `Web_https.config` to `Web.config`

Run .BAT files to make registry settings

1. From the BIS installation medium, retrieve the file: `\Tools\HttpsForBIS\EnableHttps.bat`
2. Run the batch file on the BIS server.
Result: Registry settings are adapted from HTTP to HTTPS values.

13.6.2**Configuring the Audit trail feature**

In the BIS Configuration Browser click: **System > Audit trail configuration**

Result: The Audit trail configuration window appears



- To start trailing configuration changes, select the check box **Activate Audit trail**.
 - **Note** that this activation itself is recorded in the audit trail as an action for the whole system, not just for the current configuration. Therefore, when searching the audit trail for this activation, ensure that the filter is not limited to the current configuration.

- In the text box labeled **Records expire after**, enter the number of days for which records should be protected from deletion. After this time they will be considered “expired”.
- To reduce storage space for the Audit trail, there are two mutually exclusive options for deleting expired records:
 - To start a daily cycle of purging expired records, select the check box labeled **Schedule an automatic purge** and enter the time at which the daily purge should occur.
 - To purge expired records immediately from the system, click the button **Purge expired records**.
Note that this button is not activated if there are no expired records in the system, or if an automatic purge has been scheduled.

13.6.3 Using the Audit trail feature

In the BIS Configuration Browser click: **Administration > Audit trail report**

Result: The Audit trail report window appears

- To search for records in the audit trail, create a filter that matches the records which interest you, and click the **Load/Refresh** button. Note that simply clicking the **Return** button within a filter line does **not** start the search.
 - To help you create the filter, permissible input for each cell is displayed at the top of the filter pane in red, when that cell is selected.
NOTE: when entering a date and time, follow the format in the red help text, not the format seen in the cell.
 - Note that filter settings are not saved between sessions. They are discarded upon closing the BIS Configuration Browser.
- A filter may consist of between 1 and 6 conditions on separate lines.
Note: All the conditions are combined by a logical AND.
 - To add conditions to the filter, click the [+] button .
Result: A new line appears.
 - To remove a condition from the filter. Click in the undesired filter line and then click the [X] button .
Result: The selected line is removed.
- Click the **Reset** button to discard the current filter settings.

Audit-trail filter-columns

The following table gives detail about what you can enter in the different filter columns:

	Column name	Description of contents
1	Configuration	The path and name of the configuration that was changed.
2	Menu	The main BIS menu (Administration, Locations, Connections etc.) where the change was made. Alternatively the words File Audit for a change made to a configuration file outside of the BIS Configuration Browser.
3	Screen name	The BIS sub menu below the main menu where the change was made. For example, in the case of menu Administration , the screen names are Information, Authorizations, Operators etc.

	Column name	Description of contents
4	Operator	The BIS operator that made the change, or System if changes were made outside of the BIS Configuration Browser, for example: files deleted in the Windows file system.
5	Date and Time	The date and time that the change was made. Use the date and time formats that appear in red at the top of the dialog window. You may use the SQL function @TODAY or @TODAY-N (where N is an integer between 1 and 99)
6	Action	One of ADD, MODIFY, DELETE
7	Field	NOTE: This column is read-only, and cannot be used to create filters. For each record in the audit trail the column Field is divided into separate lines. The number of lines depends on the complexity of the change, that is, how many input fields were involved.
8	Old value	The previous values of the objects listed in the Field column of this audit record.
9	New value	The changed values of the objects listed in the Field column of this audit record.

Navigating in the search results

Above the table of search results a toolbar provides the following functions for navigating through the results:

- Arrow buttons to scroll one page back or forward, or else go to the first or last page.
- A text window to enter the desired page number.
- A pull-down menu to set the size of the font.
- A text window for finding strings within the results. Enter a string to seek and click **Find** to start a new search, or **Next** to find the next occurrence of the current string.
- A button to refresh the search results
- A button to print the search results.

Exporting the search results to common file formats

Above the toolbar two controls provide a way of exporting the search results into common file formats:

1. In the pull-down menu, select the file format, for example: **PDF, Excel** or **Word**
2. Click the **Export** button to export the search results to the chosen file format.
3. You will be prompted for a location in which to save the file.



Notice!

Restrictions on cell contents in Excel

Excel restricts the contents of any cell to 32767 characters. In the unlikely event that an audit trail export exceeds this limit, an error message is produced and you will not be prompted for an Excel file name. Full details are written to the BIS error log.

Note that exports to PDF and Word will still be possible.

13.6.4 Audit trail performance

Due to the large number of files to copied, the performance of the Audit trail feature is adversely affected by the creation, loading and unloading of whole configurations. If such major changes have been planned and documented elsewhere, you may wish to consider temporarily deactivating the Audit trail feature at these times.

See also

- *Configuring the Audit trail feature, page 126*

13.7 Divisions

If a site monitored by one BIS system is occupied by two or more autonomous entities (e.g. companies, tenants, divisions) then it may be advantageous to, divide the site into separate **divisions** and assign different operators to each. These operators will only see events, locations, card holders etc. for their own divisions. The Divisions feature is licensed separately. If not licensed then all locations belong to a default division, called **Common**.



Notice!

Configuration changes of DB9000 are always logged and visible to all operators - regardless of their divisions.

From the Configuration Browser, click the **Locations** Outlook button, then select **Divisions**.



Use this screen to create, edit, and delete the configuration's divisions. If Access Engine (ACE) is configured, the ACE device editor automatically receives the division data. For more information, refer to the **BIS Access Engine Configuration online help**.

- To create a new division, click
- To delete a division, click on the division to select it, then click



Notice!

The Divisions feature is licensed separately. Division names are limited to **50 characters**. The following characters are not allowed: # < > ' " & * ? .

Color mappings

Color mappings provide a simple way of telling which locations belong to which divisions. The colors in the color column are reflected later in the configuration's location tree.

In order to select or modify the color, click the color-selector button in the respective row of the color column.

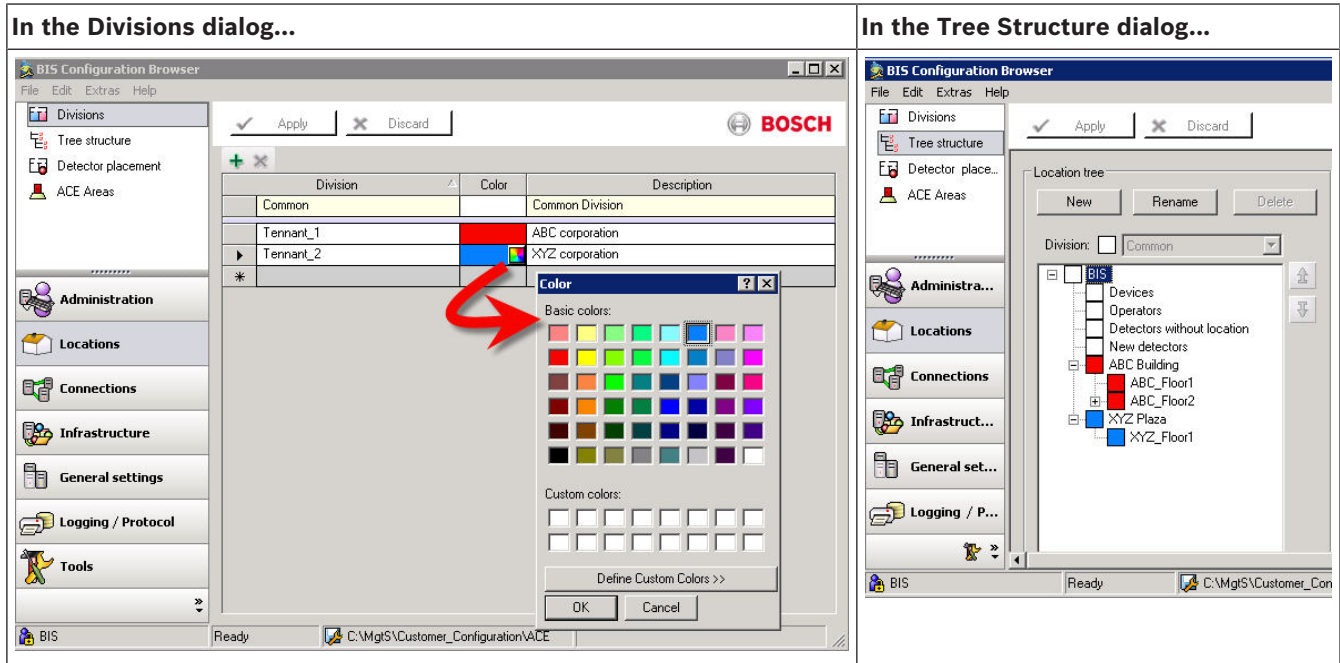

13.8

Tree structure

This dialog is where the configurator defines the hierarchy of the locations and other objects monitored by the system. For example, a site may contain buildings, which may in turn contain floors, which contain rooms etc. This dialog is where the configurator associates auxiliary files such as floor plans, action plans and miscellaneous documents with the location tree.

Click Outlook bar: **Locations > Tree Structure**. The following dialog appears. The various panes in the dialog are described in the table below.

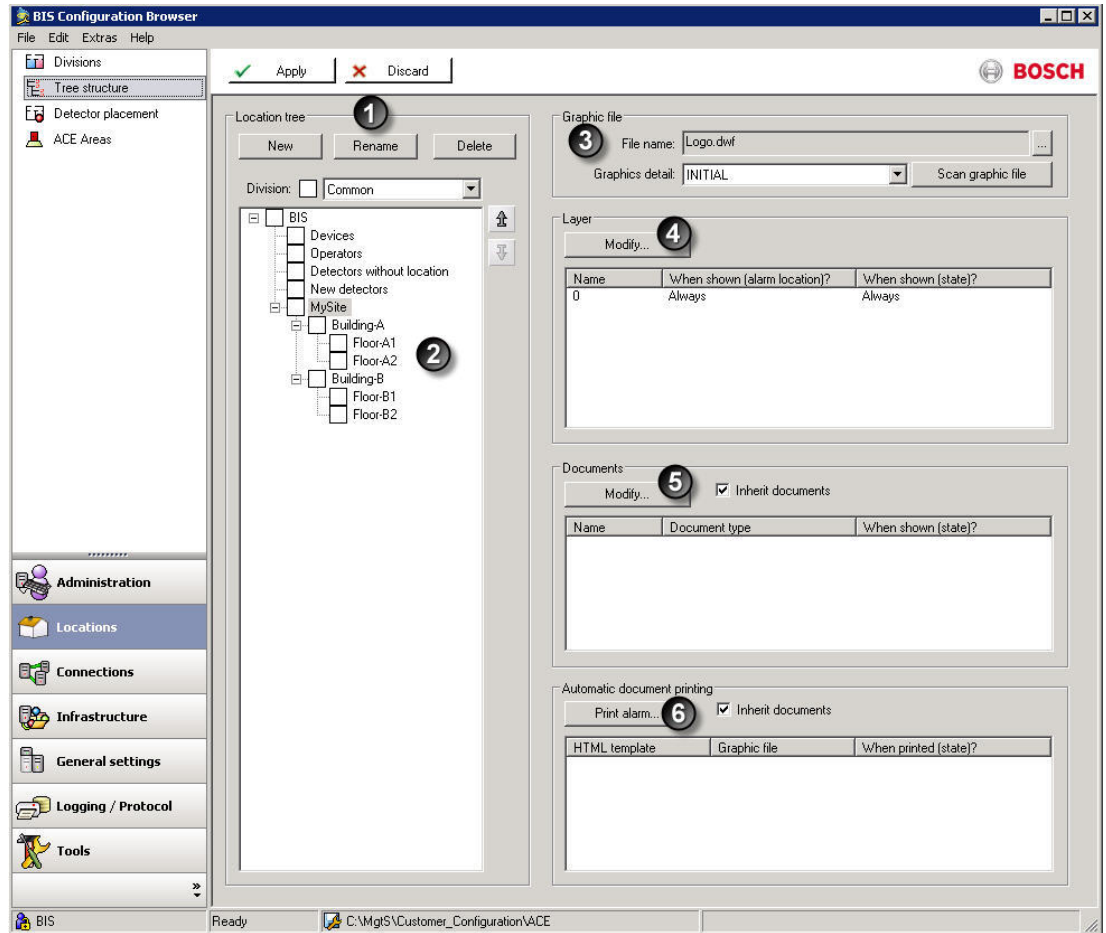

Picture tag #	Description	Purpose
1	Location tree pane	Adding, modifying and deleting objects in the location hierarchy.
2	Location tree graphic	Shows the hierarchical structure
3	Graphic file pane	Shows the name of the current floor plan (default: logo.dwf), and the current layer in that floor plan (default: INITIAL)
4	Layer pane	Selects which layer of the floor plan is to be associated with the currently selected location in the tree graphic (2)
5	Documents pane	Selects which action plan or miscellaneous document is to be associated with the currently selected location in the tree graphic (2), and when (under which state) the document is to be displayed to the operator.
6	Automatic document printing pane	Selects which documents are to be printed automatically, and when (under which state).

You may assign each node of the location tree to a graphic file (for example, a floor plan) or a named section within a graphic file (for example, a room in the floor plan). By default, the file **Logo.dwf** and the named section **INITIAL** are assigned.

Organization of auxiliary files the Location Tree

Floor plans, action plans and miscellaneous documents are stored in the appropriate subdirectory of **<INST_DIR>Customer_Configuration\MyConfig\Documents**

Directory	Description
...\Documents\Floor plans	For floor plans, layers, name sections of floor plans, detector hyperlinks, and so on.
...\Documents\Action plans	For action plans.
...\Documents\Printouts	For all other documents to be displayed in addition to the location plan (for example, dangerous substance information, first aid instructions, and so on).

13.8.1 Building the Location Tree

1. Add elements to the tree in the normal BIS way: First, if the **Divisions** feature is licensed, select the desired division from the combo box. Then select the “parent” branch in the tree to which you wish to add a sub-branch, then click the **New** button.
2. Change the order of a node within the tree by first selecting it and then clicking the arrow buttons to the right of the tree.



13.8.2 Assigning graphic files and their layers to nodes in the location tree

To assign graphic files (e.g. floor plans) to nodes in the location tree, proceed as follows.

1. Browse for the desired file using the “...” button in the **Graphic file** pane. The file name then appears in the associated text box.
2. Click the **Scan graphic file** button in the **Graphic file** pane. If this graphic file has not been scanned before, and it contains named views that should correspond to sub-locations in the location tree, then select the check box **A new sub location will automatically be created for every named view** in the pop-up dialog, and click the **Start** button. BIS then creates the appropriate nodes in the location tree automatically. You can adjust the relative positions later using the arrow buttons beside the location tree.
 - Note: If the graphic has changed since last using this dialog, click the **Scan graphic file** button to re-scan the graphics file.

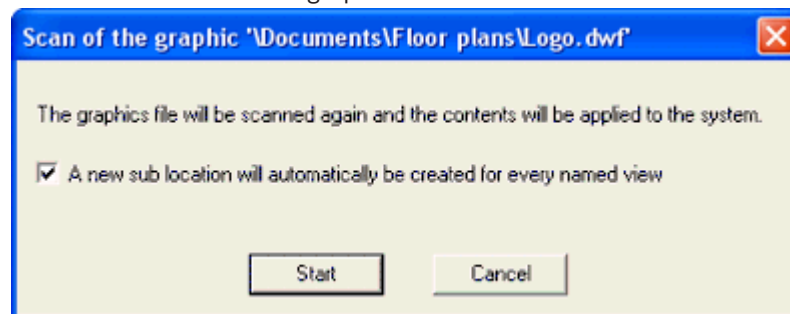

- If the naming conventions in the graphic file and in BIS are the same, then BIS automatically assigns the named sections (for example, individual rooms on a floor) to the appropriate locations. For more details, see *Configuring location plans (floor plans)*, page 77

- In the **Layer** pane, click the **Modify...** button to invoke the **Selection of layers** dialog. To restrict the display of a graphic file layer (left pane) to a particular location or a particular state, then select the respective radio button labeled **at the following locations** (middle pane) or **at the following states** (right pane). Alternatively, select the **always** radio button above the respective column, if the layer is to be displayed at all locations or at all states.

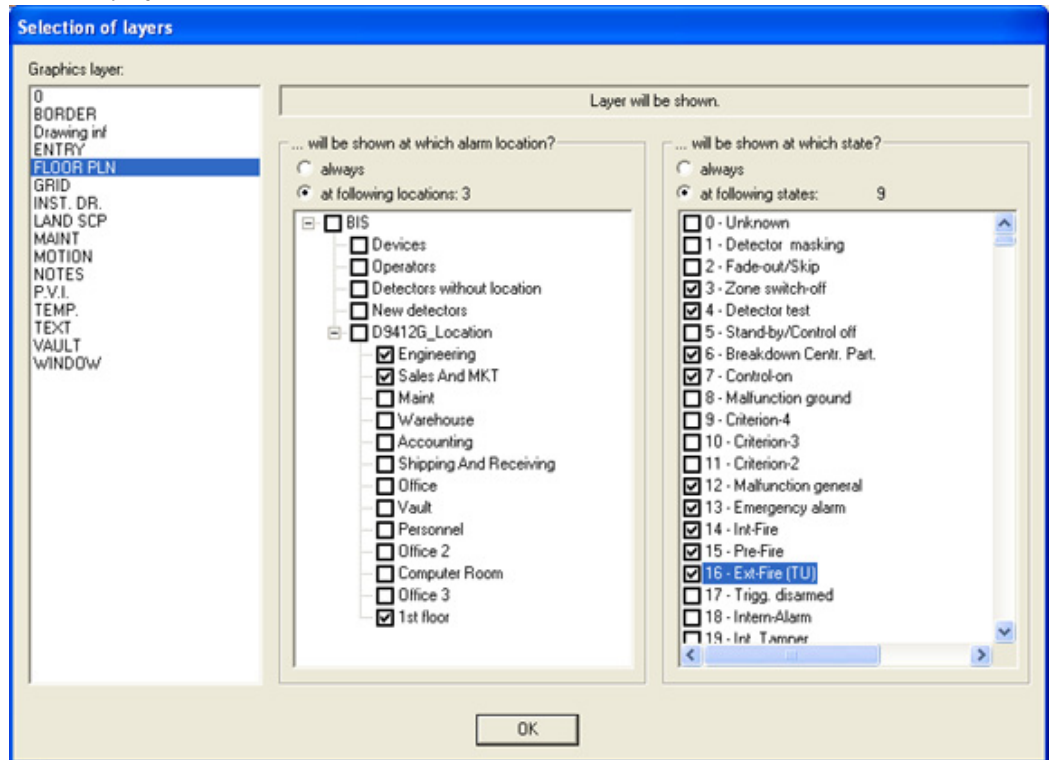

- Click **OK** to save the changes.

Example of Using Layers

The graphic for the alarm location “Savings Bank Ground Floor” contains the following layers:

- Escape route Sun Street
- Escape route Station Street

If the message “Robbery” is in process for a detector from the “Sun Street” alarm area, whenever the location “Savings Bank Ground Floor” is selected, the escape route layer for Station Street should display.

Else, for every robbery message from the “Station Street” alarm area, the escape route layer for Sun Street should display.

Required entries and assignments in the configuration:

Layer	Alarm Location	Status
Escape route Station Street	Sun Street	Robbery
Escape route Sun Street	Station Street	Fire

13.8.3 Assigning action plans and miscellaneous documents to nodes in the location tree

To assign other html documents (e.g. action plans and miscellaneous documents) to nodes in the location tree, proceed as follows. Note: An alarm message can display only one action plan,

1. Click Outlook bar: **Locations** > **Tree Structure**. In the **Documents** pane click the **Modify...** button to invoke the **Selection of documents** dialog. Click the **New** button and specify which type of document should display (miscellaneous document or action plan), and for which system states. The differences are explained in *Creating/Editing Action Plans and Action Buttons, page 80*. Click **OK** to close the dialog.

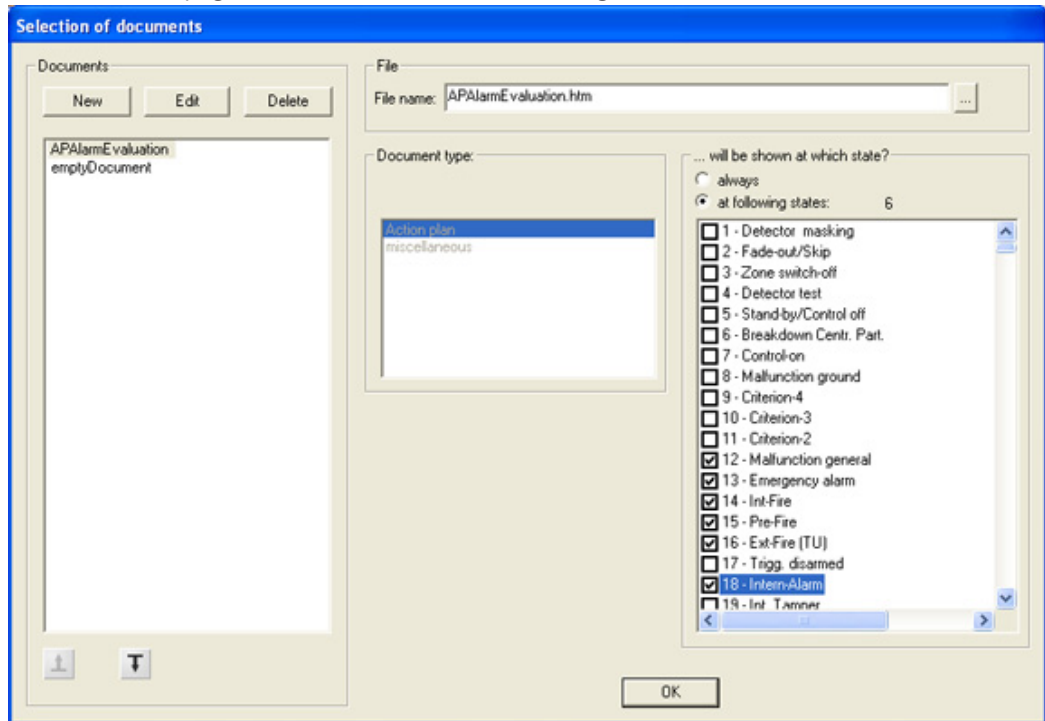

2. Back in the Documents pane, you may select the check box **Inherit documents** to ensure that the sub-locations of the currently selected location will inherit its documents. Hence multiple locations can share the same action plan by inheritance.

13.8.4 Assigning automatic alarm printouts to nodes in the location tree

To configure BIS so that a particular document is automatically printed out when an alarm occurs at a particular location, proceed as follows:

- ▶ In the **Automatic document printing** pane, click the **Print alarm...** button to invoke the **Automatic printing of documents** dialog. Here you can configure which HTML template will print, and which system events will trigger the printing.
 1. Select an HTML template using the **HTML template** pane.
 2. If you want the system to insert a graphic (e.g. a floor plan) into the template when printing, use the **Graphic file** pane to select the file, plus (optionally) a named area within the file, or a layer.
 3. If not all detectors are to be printed, they can be filtered out using the **Graphics filter** combo box.
 - Use the **...upon the following action:** pane to specify when the template should print (**At delivering a message, At acceptance of a message, or Never**).
 - Use the **...to following document printers:** pane to select which printers to use.
 - Use the **...at following message states:** pane to specify which system events will trigger the printing of the template.

Notice!

The graphic appears on the printed HTML page at the position defined by the HTML “IMG” tag.



To print using the HTML template assigned to the currently selected location, click the **New default document printout with graphic** button. This automatically enters the default template for manual printing, the current graphics file with the named section, and the selected layers.

The HTML page can contain macros, which are instantiated before printing.

Click here for more information on action plans: *Creating/Editing Action Plans and Action Buttons, page 80*

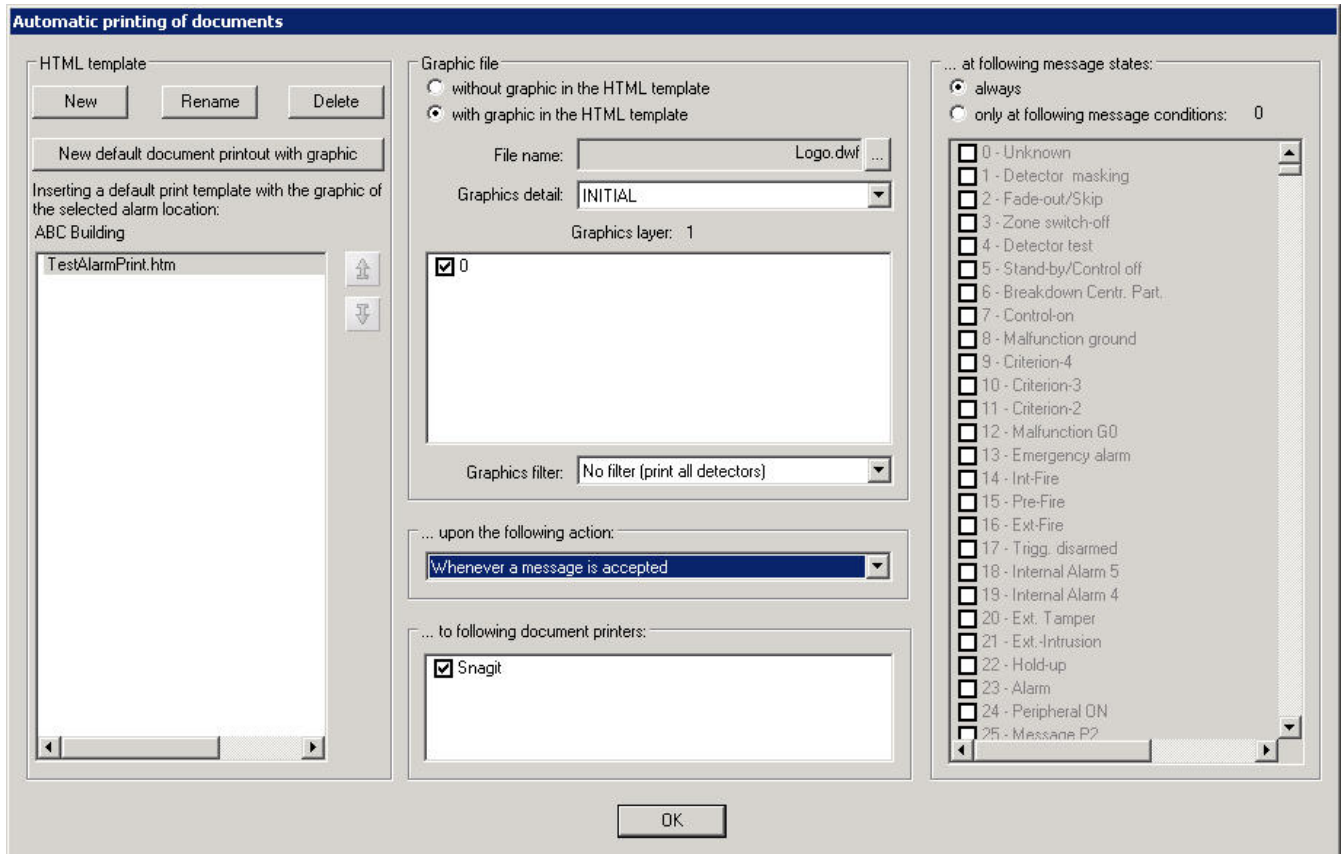

13.9 Connections and Addresses



Notice!

Changes made here are recorded in the Event Log

13.9.1 Addresses

Connections may be understood as subsystems that communicate with the BIS system. Each subsystem contains devices, each of these devices may contain detectors and each of these may contain different sensors. Every item in this hierarchy that can give a signal is identified to the system by a unique **address**. The assignment of addresses is therefore essential to the functioning of BIS.

- Most commonly addresses are assigned by **browsing** (see *Creating connections and addresses by browsing, page 136* below)

- Addresses can be also assigned individually by hand, or generated en masse for related objects using dialog boxes. The Configuration Browser offers different dialog boxes for the creation of connections, depending on the nature of the connection. E.g. fire detectors have different address requirements from cameras, door controllers or burglar alarms.

13.9.2 Creating connections and addresses by browsing

The following is the usual and most convenient procedure to create a connection from BIS to a subsystem. It is commonly referred to as “browsing” a connection.

1. In the Configuration Browser, select the **Connections** Outlook button.



2. Right-click the connection server, then select **Add Subsystem...**

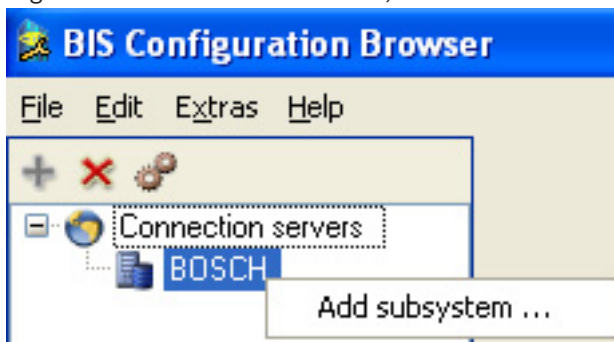

- On the left side of the **Select new subsystem** window, select the type of OPC server to add.

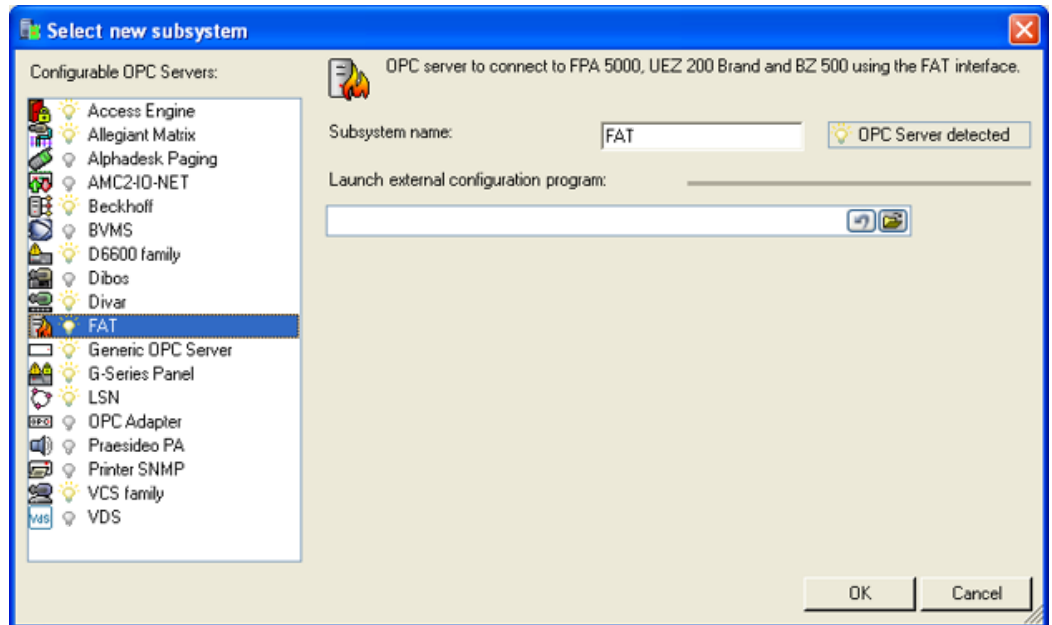

- If you have installed a new OPC server while the Configuration Browser was running, press **Refresh** to scan again for OPC servers.
- Type a name in the **Subsystem name** field, or modify the default name if desired.
- If available, the name of the appropriate OPC configuration program will appear under **Launch external configuration program**. If one exists but none has been found, click the open-folder icon to browse for it.
- Click **OK** to close the **Select new subsystem** window.
- At the top of the **OPC server (available elements)** pane, click **Connect** to find the OPC server on the network.

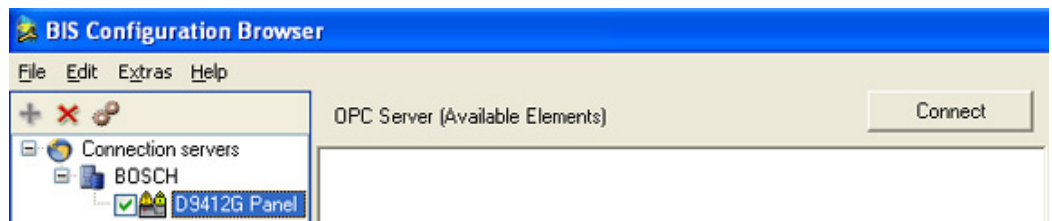

- Result: The OPC server appears in the **OPC server (available elements)** pane.

- Click the **[+]** nodes in the hierarchy to explore the namespace of the OPC server

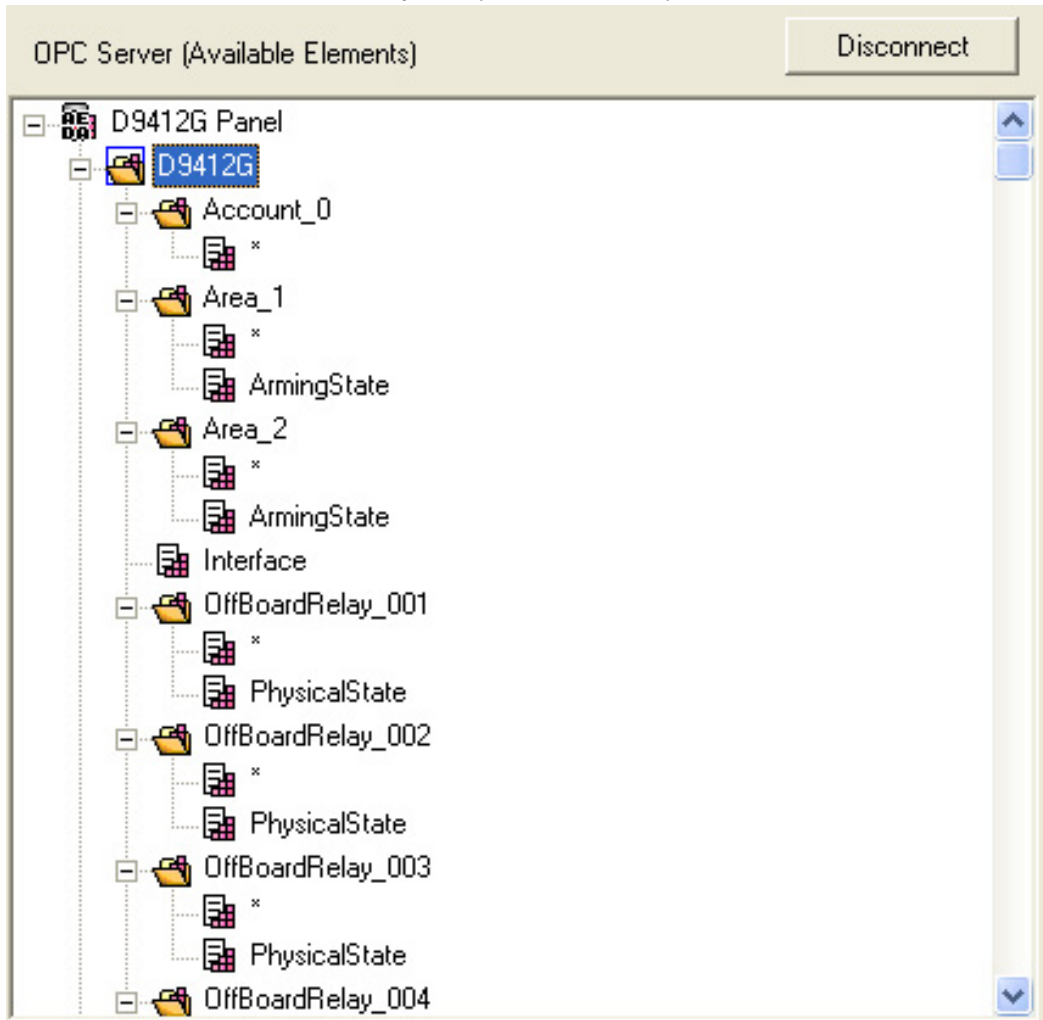

- Right-click the topmost elements and select **Add all items** or alternatively --
Right-click each OPC server element that you want to add to the configuration, then select **Add Node** from the context menu.

Result: The selected nodes appear in the **BIS Addresses (Chosen Elements)** pane

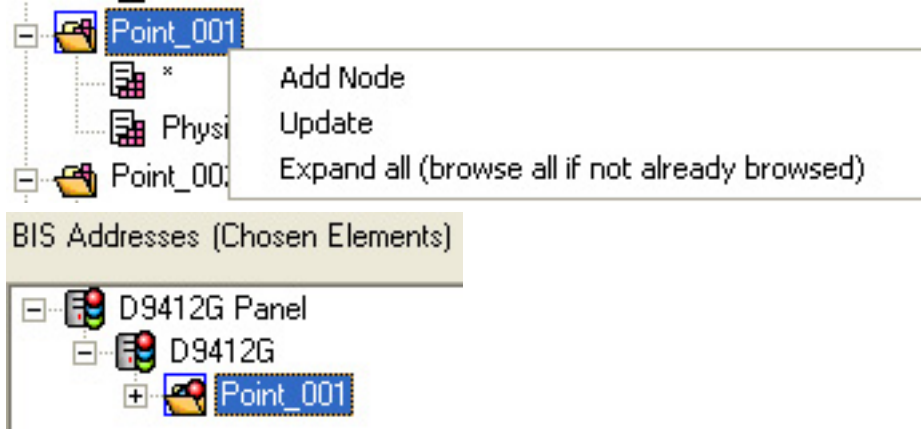

- 12. (For BIS 4.1 and higher) Use the field **Description or URL of associated camera** for a brief text description of the detector.

Alternatively you can enter the URL of a camera in the vicinity of the detector, in the format:

`http://CAMERA-IP-ADDRESS?type=VSDK&VRM=VIDEO-REC-MGR-IP-ADDRESS`

e.g.

`http://172.31.23.80?type=VSDK&VRM=172.31.23.0`

- **Effect:** If the detector raises an alarm state that is recognized by the event log, then the record in the event log will contain links to this camera or cameras. Clicking on such a link will retrieve archived recordings from that camera for the time of the alarm.
- 13. Use the **Detector Type** drop-down menu to identify the element's type.
 - 14. When you have finished adding elements, click the **Apply** button.
 - 15. Click the **Disconnect** button to stop browsing for the OPC server on the network.
Click here for more information on OPC connections in general: *OPC classic connections, page 45*



Notice!

The following characters are not allowed: # < > ' " & * ? .

13.9.3

Disabling / Enabling connections

Alongside every connection is a check box that allows you to disable and enable it temporarily for testing purposes without the need to browse and re-configure the OPC server.



Notice!

Remember to re-enable these connections after testing, else they will remain unavailable to the system.

13.9.4

Reloading OPC connections

There are typical occasions when it may be necessary to refresh definitions and assignments in BIS with updated definitions and mappings from an OPC Server.

- You wish to undo manual changes made within BIS, and restore the BIS configuration to a previous state
- The OPC Server has been updated or reconfigured, and you wish to take advantage of this update in BIS
- After adding a BVMS OPC Server connection.

Reloading is easily achieved via the context menu (right-click on node) in the **BIS addresses (chosen elements)** explorer pane. The reload affects only the selected node and its children. Prerequisites are that the relevant OPC Server be connected and its node expanded in the **OPC server (available elements)** pane.

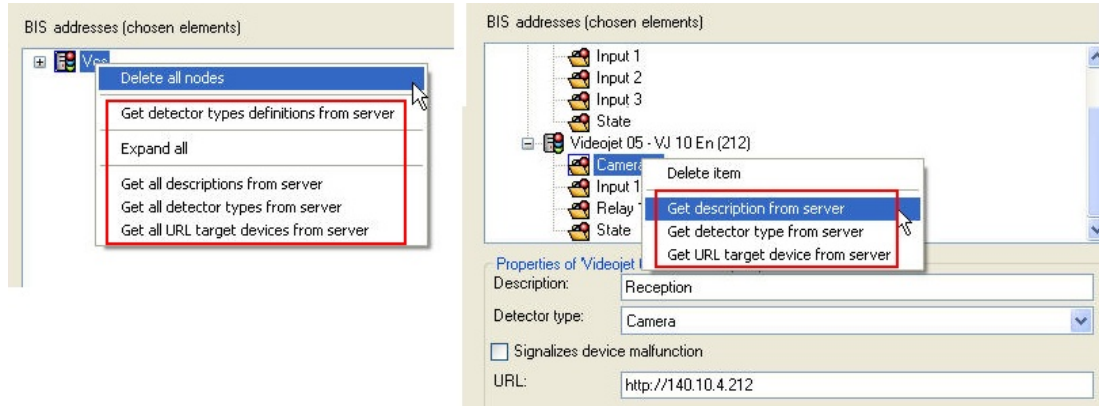

The following table summarizes the relevant context menu choices and their usage.

IF you wish to...	THEN right-click the BIS node from which point down you wish to make the change, and select:	Effect
<p>Undo changes to address descriptions made manually within the configuration.</p> <p>Load address descriptions which have changed within the OPC Server (new version, different configuration, ...)</p>	<p>Get all descriptions from server (Get description from server)</p>	<p>Overwrites the address descriptions within the configuration with those defined by the OPC Server.</p>
<p>Undo changes to detector type definitions made manually within the configuration.</p> <p>Load detector type definitions which have changed within the OPC Server (new version, different configuration, ...)</p>	<p>Get detector types definitions from server</p>	<p>Overwrites the detector type definitions within the configuration with those defined in the OPC server.</p>
<p>Undo changes to detector type assignments made manually within the configuration.</p>	<p>Get all detector types from server (Get detector type from server)</p>	<p>Overwrites the detector type assignments of each address within the configuration with those defined by the OPC Server.</p>

<p>Load all detector type assignments which have changed within the OPC Server (new version, different configuration, ...)</p>		
<p>Undo changes made manually to URLs within the configuration.</p>	<p>Get all URL target devices from server (Get URL target device from server)</p>	<p>Overwrites the URL definitions of each address within the configuration with those defined by the OPC Server.</p>
<p>Load URLs which have changed within the OPC Server (new version, different configuration, ...)</p>		



Notice!

The first time a BVMS connection is added it is necessary to invoke **Get detector types definitions from server** from the context menu.

13.10 Detector placement

Introduction

A BIS configuration stores all known devices in its Device Tree, and all known locations (areas, sub-areas) in its Location Tree (“Tree structure”). If you want to make full use of the location graphics extension to BIS, then it is necessary to create an interactive mapping between the device and location trees on the one hand, and the hyperlinks and sub-areas respectively in the location graphics.

BIS offers considerable support in creating this mapping, and that is the subject of this section.

Detector placement prerequisites

- You must have already created a location tree, see *Tree structure, page 130*
- You must have defined the required detectors with their respective types and preferably assigned symbols to them.
- (If using location plans) you must be in possession of an AutoCAD location graphic in DWF or HSF formats. The graphic file should contain hyperlinks to the addresses of detectors. It may also contain named sub-areas, also known as named sections or named views.

Select the Configuration Browser's **Locations** Outlook button, then click **Detector placement**.

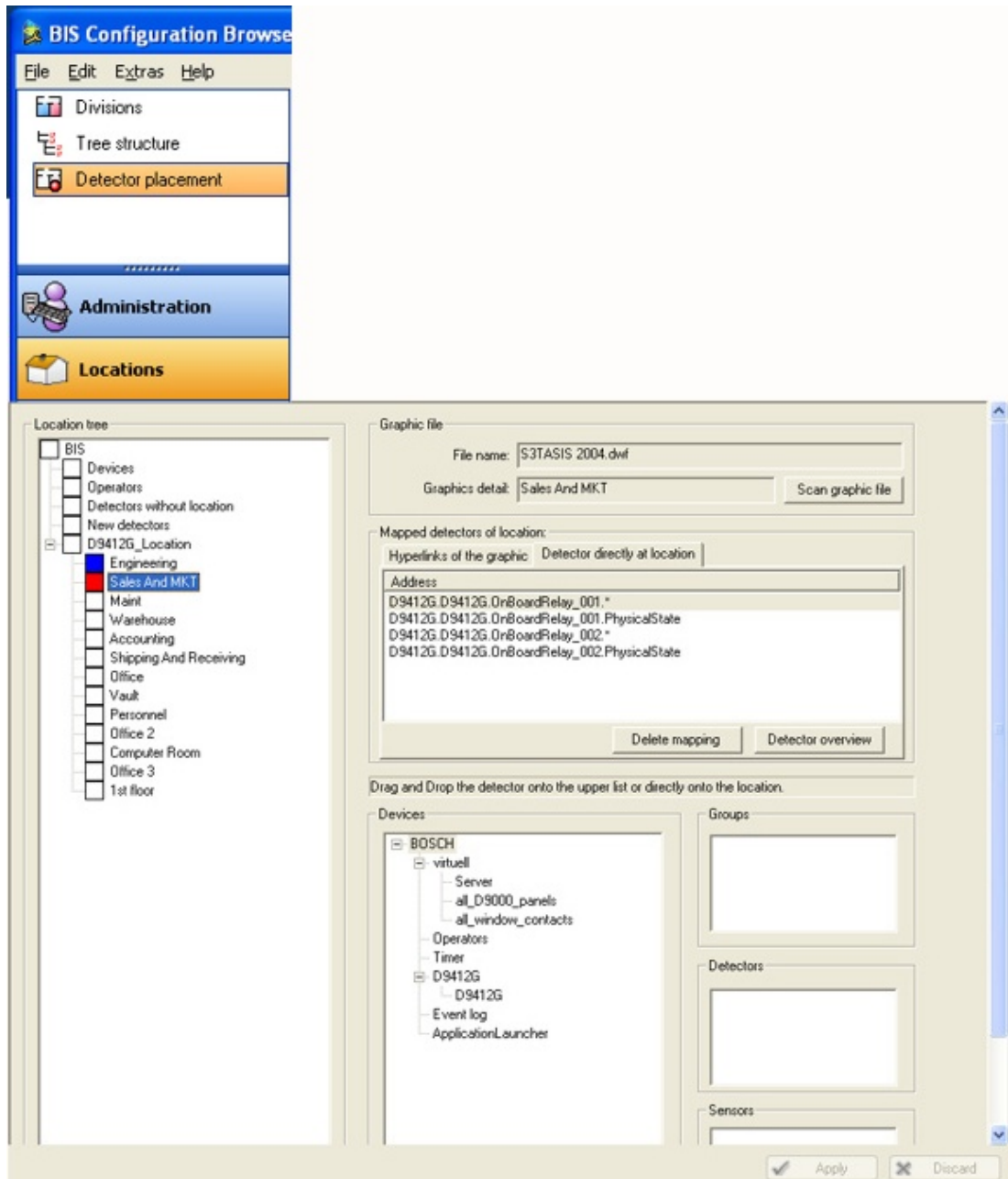

Procedure for mapping detector-addresses to locations

Optimally the producer of the graphic file should use the same naming scheme for sub-areas within it as has been used in the location tree within BIS. Likewise there should be in the graphic file hyperlinks whose names match the addresses in the device tree. If this is the case, then BIS is able to create interactive mappings between hyperlinks and detector-addresses on the one hand, and between sub-areas and BIS locations on the other.



Notice!

Consequently, the producer of the graphic file must **not** give to a hyperlink the name of a location instead of the address of a detector. This would create an unusable mapping within BIS, and would have to be removed by deleting and re-creating the hyperlink.

Instead, always associate by name:

Hyperlinks in the graphic with device addresses

and

Sub-areas in the graphic with locations in the BIS location tree.

The mapping of detector-addresses to locations proceeds differently depending on the scenario, i.e. on whether a graphic file exists at all, and if so, on the naming scheme of the elements within it.

Scenario	Action	Procedure
<p>Either there is no graphic file available, or else no hyperlinks or sub-areas are present in the AutoCAD graphics.</p>	<p>Manual mapping of addresses to locations</p>	<p>From the device tree, choose the appropriate units and addresses, and drag&drop them to the desired location in the location tree. This is can be done with multiple selections also.</p>
<p>In the AutoCAD graphic, the same naming scheme has been used for hyperlinks that was used for detectors in the BIS configuration.</p> <p>And the same naming scheme has been used for sub-areas that was used for locations in the BIS configuration.</p>	<p>Automatic mapping of addresses to hyperlinks</p>	<p>Click the Scan graphic button. The scanning process seeks to maps the hyperlinks in the graphics to BIS detectors of the same name.</p> <p>A popup window appears with the following options: All named views of the graphic will be checked (for all sub locations of ‘New detectors’) Select this check box to scan the graphic file for items in named views (sub areas) within the graphic. If an item occurs in two overlapping named views, then the first named view to be scanned gets the item. Changes can be made manually later.</p> <p>The names of the devices (before the group name) are contained in the links. Select this check box if the same naming scheme has been used within BIS and in the graphic file, and BIS should attempt an automatic mapping.</p> <p>In links the following will be used as a separator [.] If a different separator character has been used in the graphic’s hyperlink names from the standard “.” separator in BIS, then it can be entered here, to help BIS achieve the mapping. E.g. Hyperlink IPCamera/1 can be mapped to BIS address IPCamera.1.</p> <p>Existing links will be overwritten</p>

Scenario	Action	Procedure
		Select this check box if the graphic has changed considerably, and the previous mappings of addresses and hyperlinks are no longer valid. Clear this check box if only minor additions are to be made.
After using Scan graphic there are still detector addresses missing next to the hyperlinks in the list window (pane: Mapped detectors of location. > tab Hyperlinks of the graphic.)	Manual mapping of addresses to hyperlinks	Select the desired detector or detectors from tree in the Devices pane, or one of its sub-panes (Groups, Detectors, Sensors). Drag and drop them onto the corresponding hyperlinks in pane: Mapped detectors of location. > tab Hyperlinks of the graphic.

**Notice!**

The following characters are not valid within location links: & <> ‘ “

13.10.1**Controlling layer visibility through states****Introduction**

BIS can be configured to display or hide a layer of a location plan depending on the current state of a BIS address.

The visibility of one graphic layer can be made dependent on only one address, but on any combination of states valid for that address.

The configuration procedure is described in this section.

Prerequisites

A location plan has been created in the configuration.

At least one layer other than layer 0 has been created within the location plan.

A BIS address (usually a detector) has been anchored on **layer 0** via a hyperlink.

Enabling and disabling Layer visibility by state

BIS provides batch command files to enable, disable and check the current setting of this feature. The batch files are located on the BIS installation medium at the following paths:

```
_install\Tools\LayerControlByStatesActivation\EnableFeature.bat
_install\Tools\LayerControlByStatesActivation\DisableFeature.bat
_install\Tools\LayerControlByStatesActivation\DisplayFeatureStatus.bat
```

**Notice!**

Precedence of Alarms and States in deciding layer visibility

By default in BIS, alarms take precedence over states in deciding the visibility of a graphic layer. Enabling the feature implicitly reverses this priority, so that states take precedence over alarms.

Procedure in the Configuration Browser

1. Open the dialog **Locations > Detector placement**
2. In the dialog pane **Mapped detectors of location** click the button **Layer and states**
The dialog **Layer and states** opens
3. In the **Layer** pane of the **Layer and states** dialog, select the layer whose visibility is to be controlled
4. In the **Mapped address** pane, select the device that is hyperlinked to layer 0 of the graphic
5. In the **...shown at state** pane, select the check boxes of all those states that are to cause the layer to appear.
6. Click **OK** to save.
7. Upon return to the **Locations > Detector placement** dialog click **Apply**
8. Save and load the configuration.

Testing layer visibility in the BIS Client

1. Restart the BIS client with the modified configuration.
2. In the BIS client, load the layered graphic in the **Document Display Area**.
3. Verify that the mapped layer is not currently displayed.
4. In the graphic or in the **Device overview** right-click the detector whose states you have mapped to a graphic layer.
5. In the parameters dialog enter the number of one of the states that is mapped to the layer.
6. Verify that the layer appears in the graphic.
7. Right-click the same detector in the graphic.
8. In the parameters dialog enter the number of a state that is **not** mapped to the displayed layer.
9. Verify that the graphic layer disappears from the graphic.

Limitations and restrictions

The following restrictions currently apply to controlling layer visibility by state.

- Map a detector address to only one graphic layer. Nevertheless any combination of states of the address can be used.
- Use only detector addresses that are defined as hyperlinks on layer 0 of the graphic.
 - **Detectors directly at location** are not supported.
- Ensure that layer 0 is always visible.
- In order to assign a different graphic file to a detector address, delete and re-create the detector.
- Delete and re-create the entire layer/state mapping if you remove layers or links from a graphic file.
- After replacing a graphic file in a BIS location, re-scan the graphic file. Click the buttons
 - **Locations > Detector placement > Scan graphic file** and
 - **Locations > Tree structure > Scan graphic file**

13.11 States

A state is the condition of a detector. In rare cases it may make sense to create new states, but BIS offers a large number of predefined states to choose from.

From the Configuration Browser, click the **Infrastructure** Outlook button, then select **States**.



Use this screen to tell BIS which line states to use, and specify:

- Which priority a particular state has (0 to 99)
- How, in the event of a message, the state is presented on the user interface (foreground/background colors, sound file to be played)
- The text name of state

**Notice!**

The overview dialog offers the predefined states 0 to 4999 and 9999 (“Welcome”).

With the exception of 9999 these can not be modified.

New states can be created within the range 5000 to 9998.

It is not possible to reassign a newly created state (> 4999) into the range of predefined states (< 5000).

States dialog overview

The screenshot shows the States dialog overview with five numbered callouts:

- 1**: States section with New, Rename, and Delete buttons.
- 2**: State lists section with a dropdown menu and New, Rename, and Delete buttons.
- 3**: A table listing states with columns for State, Priority, Text, Audio, and Used in lists.
- 4**: Malfunction states section with dropdown menus for Malfunction of system and Malfunction of detectors.
- 5**: Audio files section with an Info button.

State	Priority	Text	Audio	Used in lists
0	63	Unknown	BISAlarm.wav	<not used>
1	18	Detector masking	BISAlarm.wav	Masked, Revision Standby
2	1	Fade-out/Skip	BISAlarm.wav	Revision message
3	30	Zone switch-off	BISAlarm.wav	Switch Off
4	14	Detector test	BISAlarm.wav	Revision message
5	28	Stand-by/Control off	BISAlarm.wav	Standby detectors
6	16	Break-down Centr. Part.	BISAlarm.wav	Malfunction Detector
7	27	Control-on	BISAlarm.wav	Control on
8	15	Malfunction ground	BISAlarm.wav	Malfunction System
9	24	Criterion-4	BISAlarm.wav	General Message
10	25	Criterion-3	BISAlarm.wav	General Message
11	26	Criterion-2	BISAlarm.wav	General Message
12	13	Malfunction G0	BISAlarm.wav	Malfunction Detector
13	12	Emergency alarm	BISAlarm.wav	<not used>
14	9	Int Fire	BISAlarm.wav	Fire internal
15	11	Ext Fire	BISAlarm.wav	Fire internal
16	2	Ext Fire	BISAlarm.wav	Fire external
17	18	Trigg. disarmed	BISAlarm.wav	Internal Alarm
18	8	Internal Alarm 5	BISAlarm.wav	Internal Alarm
19	7	Internal Alarm 4	BISAlarm.wav	Internal Alarm
20	6	Ext. Tamper	BISAlarm.wav	Tamper
21	5	Ext.-Intrusion	BISAlarm.wav	Intrusion

The numbered labels (1) through (5) are described in the sections below.

States (1) and State Lists (2)

Use the **State lists** section of the screen to combine states into groups. This simplifies the writing of Associations by allowing them to react to different states in the same way. For example: to switch on a backup device whatever malfunction occurs in the original device. From the State List combo box you can select existing lists.

The screenshot shows the BIS Configuration Browser interface. The 'States' section is active, and the 'State lists' dropdown menu is open, showing a list of states including 'Control on', 'Door fault', 'Door locked', 'Door normal', 'Door open', 'Door permanently open', 'Fire external', and 'Fire internal'. The 'Control on' state is highlighted.

You can create **New** lists and states, **Rename** existing lists and states or **Delete** them. On the user interface, use state lists, for example, to filter detectors on the location graphic.









Notice!

If states are needed in e.g. Associations, the number of states can be smaller than the total states known to BIS. This will be the case, if a state mapping had been defined in the **Detector Type** definition.

State Lists Table

All State lists appear in the state lists table.

- Click in the heading of a column to sort them in ascending or descending order.
- Click **New** in the **State lists** area to create a new state list.
- Click **New** in the **States** area to create a new state.
- You can also **Rename** and **Delete** state lists and states.
- Click  to change a state's text color.
- Click  to change a state's background color.
- Use the     buttons to play, stop, delete, or select a sound file that will play when BIS detects the state.



Notice!

The following characters are not allowed for States or State Lists: # < > ' " & * ? .

Malfunction states and supervision addresses (4)

Use the **Malfunction states** combo boxes to define how BIS signals OPC server and detector faults.

For many individual OPC devices it is possible to designate one of the addresses as a supervision address, i.e. one that signals only whether or not the device is malfunctioning (or disconnected). This is done by selecting the check box labeled **signals device malfunction** (or equivalent wording depending on the OPC server) when defining the state. The BIS state machine monitors supervision addresses especially and responds to them as defined in these combo boxes:

Combo box labeled:	Description
Malfunction of system	If the state you select here occurs on one of the designated supervision addresses then ...
Malfunction of detectors	... all the detectors of the same OPC device are set to the state you select here.



Notice!

The BIS state machine takes account of supervision addresses when processing Associations: If, for example, an address goes into a state X that triggers an Association, and if that address signals the same state X after having signaled a malfunction on the supervision address in the meantime, then the BIS state machine recognizes that state X was the last valid state before the malfunction, and does not trigger the Association again for the same address.

For more details on defining Associations see *General procedure for configuring Associations, page 178*

Audio file (5)

The audio file associated with this state is played when BIS detects the state. Here you will find information on the size and transmission time of the audio files used.

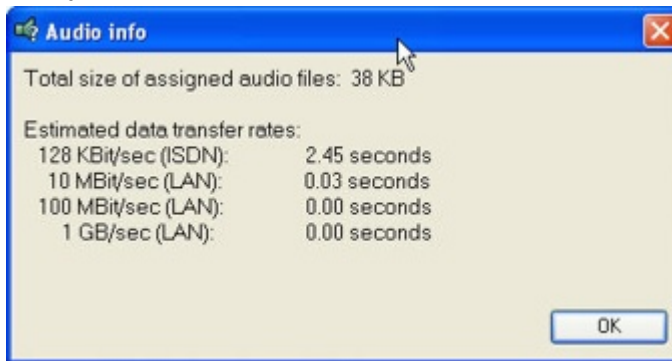

13.12

Detector type

In the Configuration Browser, select the **Infrastructure** Outlook button, then click **Detector type**. In addition to the standard detector types already available in the system, you can set up any number of new detector types.

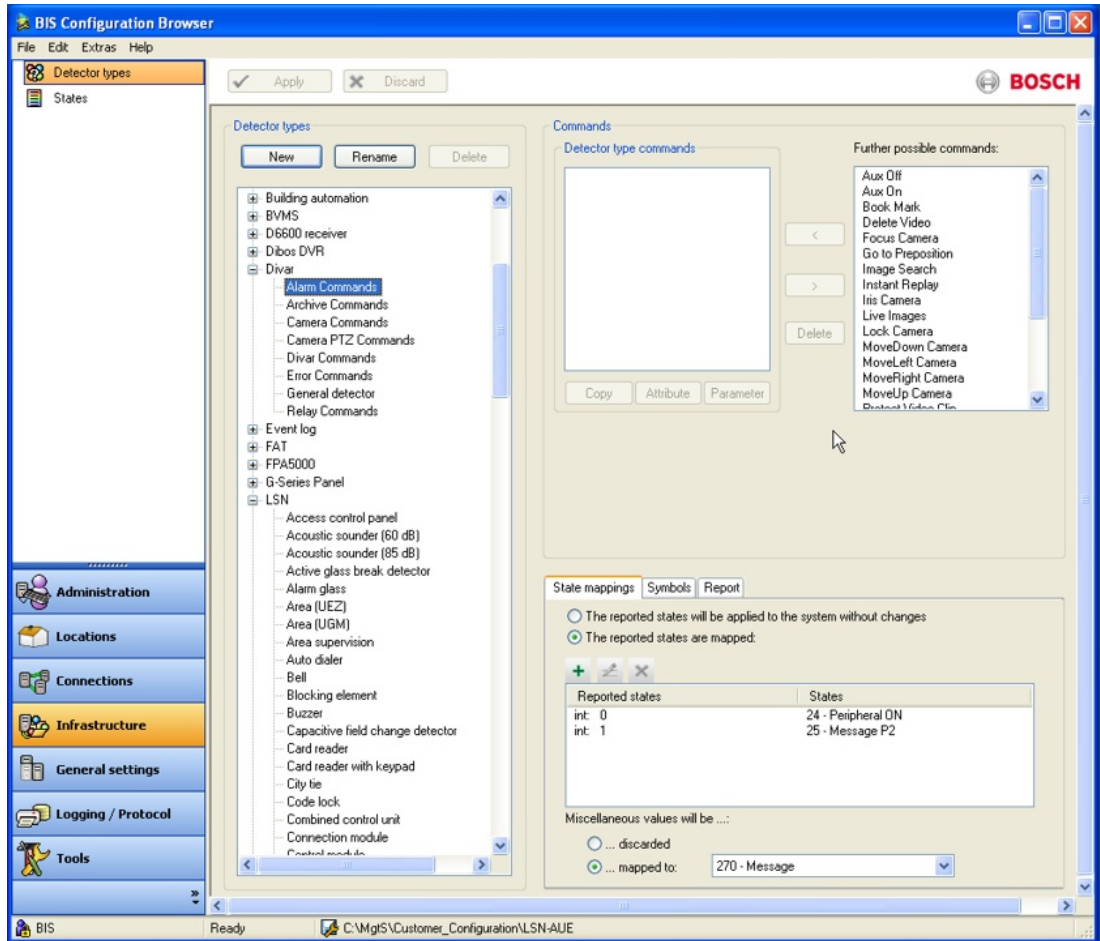

To create a new detector type, provide the following information:

- The name of the new detector type.
- An icon to represent the detector type. To use your own detector icons copy the icon files to the following directory on the BIS server.
- The set of commands that can act on all detectors of this type. For ease of configuration, detector types inherit the commands of certain basic types. These inheritance hierarchies are not themselves modifiable.
- The states themselves that are mapped to ranges of the physical values coming from the detectors. See *State mappings*, page 152 below

Details of these procedures are given in the following sections.



Notice!

The commands configured here can later be invoked by right-clicking their devices in the location or device overviews of the BIS user interface.

Copying commands

For ease of configuration, new commands are defined by copying and adapting existing ones. Proceed as follows:

1. In the list **Detector Type Commands** left-click the command you wish to copy.
2. Click the **Copy** button below the list
3. Change the default name of the copied command (e.g. **<Command_name>_Copy1**) by clicking the command name once to select, and then once more to make the name editable directly.

Changing command names

The list of commands displayed to the BIS operator is sorted alphabetically. Change the order of these commands by changing their names, e.g. by prefixing an underscore “_”.

Click the command name once to select it, and then once more to make the name editable directly.

Command attributes

The following command Attributes (as opposed to Parameters) can be defined:

- **Description** of commands
- Startpage (**not defined for all commands**)

Select a command in the **Detector Type Commands** list and click the **Attribute** button to open the dialog.

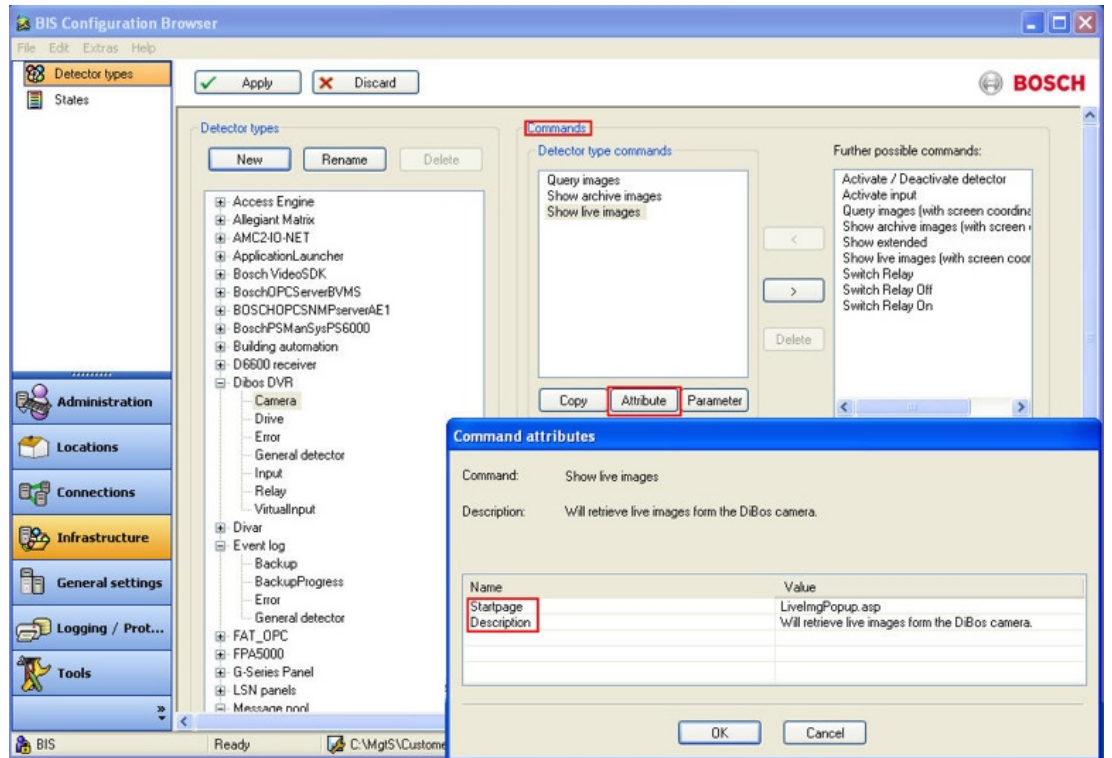

Command parameters

Once a command has been copied and renamed it is possible to redefine its parameters.

1. Select the copied command in the **Detector Type** Commands list
2. Click the **Parameter** button to open the dialog.
3. Clear the check box in the **Keep macro** column.
4. Redefine the parameter values by editing the cells in the list.

Note that commands that do not require a parameter are transmitted immediately. Commands that require a parameter will not be transmitted until the operator has supplied a value in the pop-up window.

Fast Access command

Every detector type can have one (and only one!) **Fast Access Command**. These commands are invoked by a button in the BIS client. To achieve this, prefix the command with an exclamation mark e.g. **!Reset**

Fast Access Commands can be configured for any detector type.

Hiding commands

You may also hide detector commands from operators. Hiding commands means preventing them from appearing in the context menu of the detector type in the BIS client. To achieve this, prefix the command with a tilde character e.g. **~Reset**

State mappings

If the system records States (e.g. analog values from a thermometer) which do not match the regular States for an alarm system, then these values are usually mapped to States in order for BIS to interpret them. This process is known as **State mapping**.



States can be mapped either to discrete values (e.g. “Switch open”, “Alarm” etc.) or alternatively to ranges of values (e.g. the mapping of temperature range “5° to 45°C” to State “Standby” and “46° to 70°C” to State “Pre-alarm”).

The mapping applies to all detectors of the same type.

Displaying raw OPC data

Since BIS 3.0 it is possible to display analog values directly to the BIS user interface without state mapping. A demonstration OPC server and a sample index page are provided with the BIS installation. For details see *Displaying raw OPC data, page 88*

To define a state mapping:

1. Select Outlook button **Infrastructure > Detector types**
2. Select a Detector type from the **Detector types** pane
3. On the **State mappings** tab select the **reported states are mapped** option, then click the **New**  or **Modify**  button.
4. From the dialog that opens, select the **Data type** of the value as supplied by the corresponding OPC server.
5. Enter a **Single value** or **Value range** to be mapped and select a **State** for it, then confirm with the **OK** button.

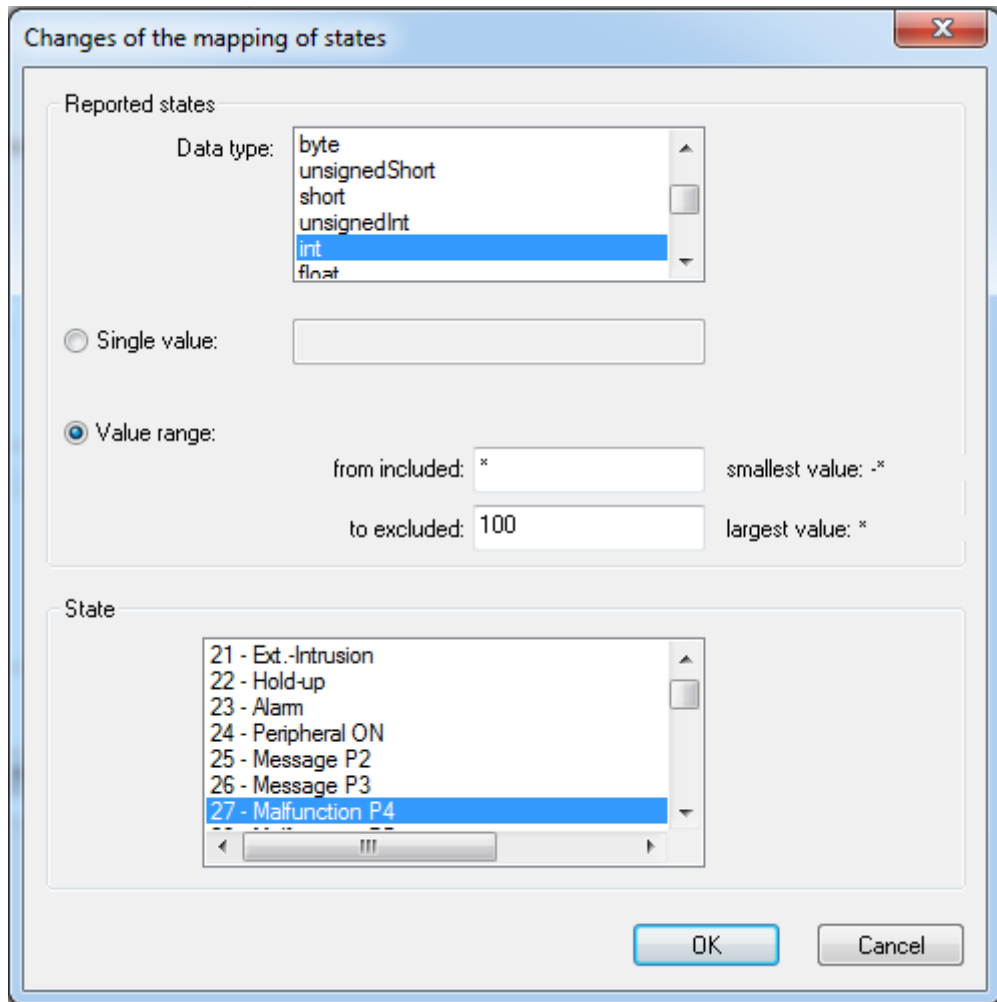

Notice!



Value range

The upper value itself is **not** included in the range

You can use the wildcard character * (asterisk) in the **Value range** fields.

For example, if you enter * in the **smallest value** field and 100 in the **largest value** field, then any value that is 99 or smaller is valid.

You can configure multiple mappings for each detector type.

You can also select a line state to which values that are not listed in the **State mapping** table are mapped at runtime.

Value Ranges of the Data Types Used



Notice!

BIS tries automatically to identify any data type coming from an OPC server. Ensure that you select the correct data type.

Data Type	Name	Memory Requirement	Value Range
string	VT_BSTR	varies	1 to approximately 65400 characters

boolean	VT_BOOL	2 bytes	True = -1, False = 0
unsignedByte	VT_I1	1 byte	-128 to 127
byte	VT_UI1	1 byte	0 to 255
unsignedShort	VT_UI2	2 bytes	0 to 65535
short	VT_I2	2 bytes	-32768 to 32767
unsignedInt	VT_UINT	4 bytes	0 to 4294967295
int	VT_INT	4 bytes	-2147483684 to 2147483647
float	VT_R4	4 bytes	for negative values: -3.402823E38 to -1.401298E-45 for positive values: 1.401298E-45 to 3.402823E38
double	VT_R8	8 bytes	for negative values: -1.79769313486232E 308 to -4.94065645841247E- 324 for positive values: 4.94065645841247E- 324 to 1.79769313486232E3 08
dateTime	VT_DATE	8 bytes	01 January 100 to 31 December 9999
DECIMAL	VT_DECIMAL	16 bytes	16 byte fixed point
CY	VT_CY	8 bytes	-922337203685477.5 808 to 922337203685477.58 07 (for currencies)

Click the **Apply** button to save any changes. After reloading the configuration the new command will appear in the context menus of detectors with the modified type State Mapping

State dependent detector symbols

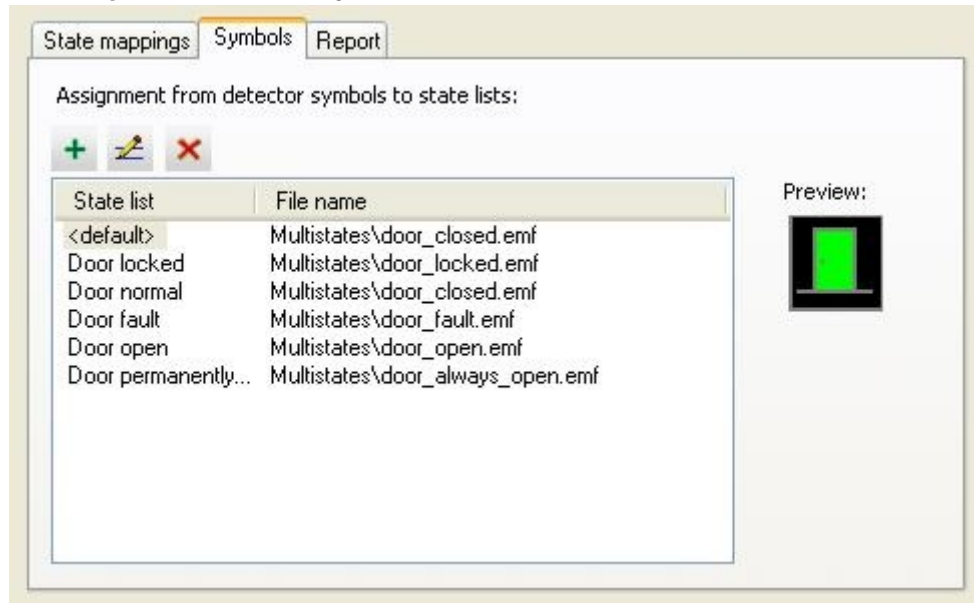

You can so configure the detector type, that not only background color but also the symbol itself changes in accordance with the state.

To do this, proceed as follows:

- Add the states needed to new or existing **State Lists**. Each state represented by another symbol must be in a separate State List.
- If you wish to use your own symbols, copy these icon files to the corresponding directory on the BIS server. The default location is **c:\MgtS\Default_Configurations\Common\Documents\Symbols**
- Add an entry for each of those State Lists and select a graphic file for it

Examples:

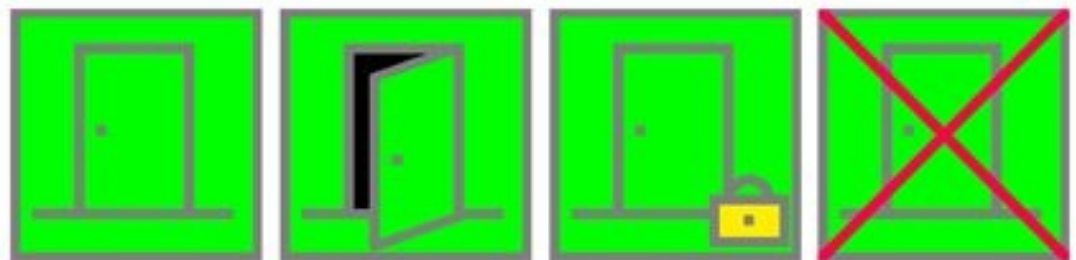

Detector Types for Interface Faults

An OPC server which also reports interface faults requires the detector type **Error**. The condition mapping must be so defined that the detector type **Error** reports to the OPC server the state which was defined in the **States** list in the pane **Malfunction States**.

New Detector Type "VIE Camera"

The new (since BIS 2.3) virtual detector type "VIE Camera" offers the following commands:

- Show live image
- Show archive images
- Search

If this virtual detector is configured you can view for example live pictures of this camera on a BIS client without (client-) VIE.

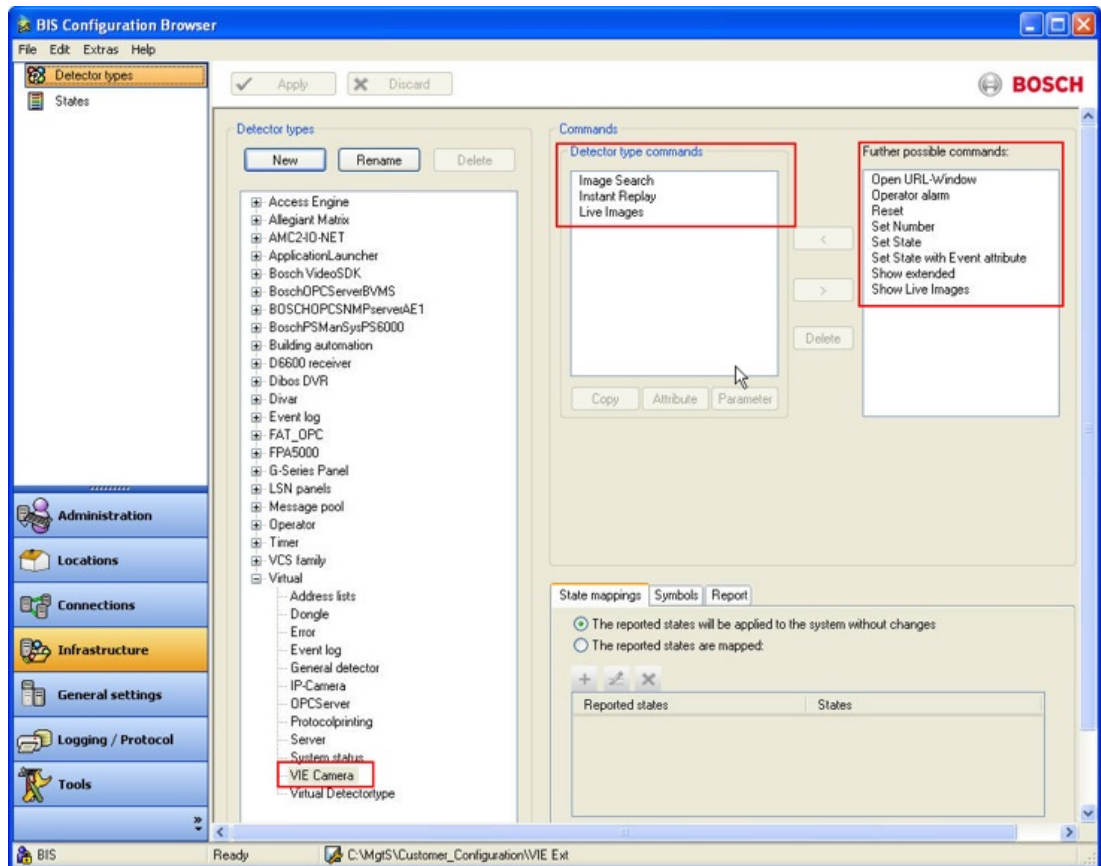

Associating detector types with URLs

Since BIS Version 2.3 a new command **Show extended** is potentially available to all detector types in BIS configurations, although not necessarily associated by default. The command opens a new browser window at the URL which you enter as its first parameter, or else prompts for the URL when the command is invoked by right-clicking the detector in the Device- or Location overviews.

Procedure

If your users need to be able to access a URL from a particular detector type you can add the command to its context menu as follows:

1. In the Configuration Browser click **Infrastructure > Detector types**.
2. Select the desired detector type from the **Detector types** list.
3. Select the **Show extended** command from the list of **Further possible commands** and place it in the list **Detector type commands** by clicking the **<** button.
4. Select the **Show extended** command (now in the **Detector type commands** list) and click the **Copy** button to create a copy.
5. Type over the name of the copy to rename it, if required. The name you choose will appear in the detectors' context menus. (**Note:** Any number of copies can be made under different names. When you have finished making copies you can return the original **Show extended** item to the list of **Further possible commands** by selecting it and clicking the **>** button.)
6. Select your copy and click the **Parameter** button. The Parameter entry dialog appears.
7. Here you can enter the desired URL, the coordinates of the browser's top-left corner and its window size. **Note:** it may be necessary to clear the **Keep macro** check box before you can enter the URL.

- Click the **Apply** button to save these changes. After reloading the configuration the new command will appear in the context menu of detectors of the modified type.



Notice!

The first time an operator uses a **Show extended** command after logging on to the client, they may experience a delay in opening the URL. The delay is commonly caused by the Internet Explorer checking by default for the revocation of certificates.

Workaround: In Internet Explorer **Options > Advanced** tab clear the check boxes for following items:

Check for publisher's certificate revocation

Check for server certificate revocation

Associating BIS reports with detector types

Since BIS Version 2.3 a new command **Show report** can be invoked via the context menus of all detector types in the BIS client. Its effect is to display the BIS report associated with this detector type.

To associate a specific report with a detector type proceed as follows:

- Click the **Reports** tab in the lower right panel of the **Detector types** dialog
- Browse the desired report type using the "..." button (see the BIS Operation online help for a description of the report types available). Both standard or user-defined reports can be used.

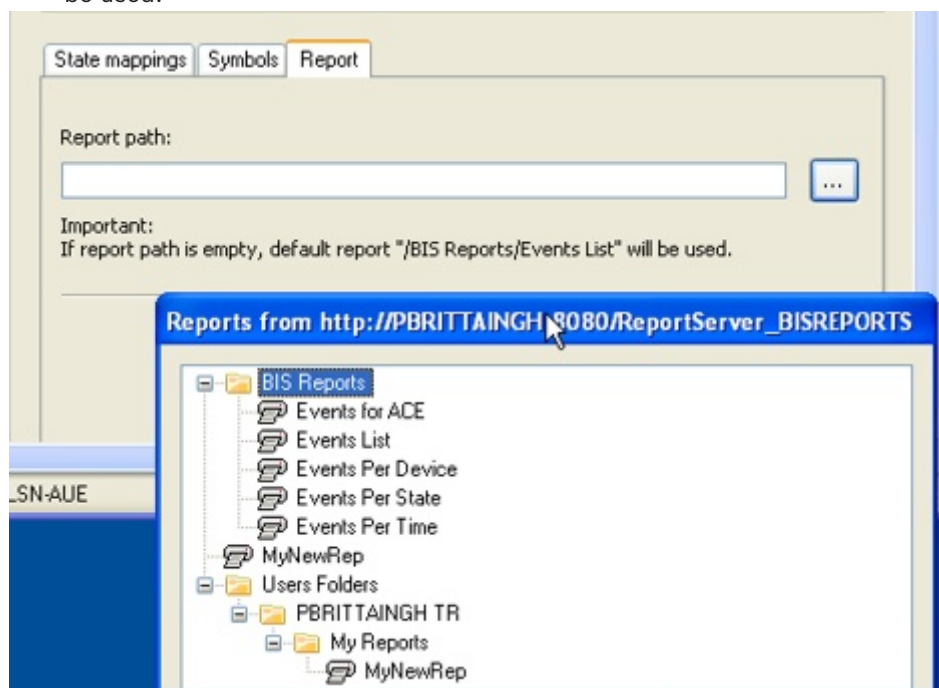

13.13 Symbols and symbol-blinking

Composition of detector symbols (default)

Detector symbols consist of vector graphics in .EMF format (EMF - Enhanced Metafile is a file format for vector graphics developed specially for 32-Bit Windows-Systems).

The factory default composition of these vector graphics (2D) is:

- The square symbol frame - gray: (RGB: 127, 127, 127)

- The symbol's graphic (or alphanumeric) content - gray: (RGB: 127, 127, 127)*
- The background color - green: (RGB: 0, 255, 0)**

*) The graphic symbolizes, for example, the respective detector type, its state or the object.

**) Only this color setting allows the configuration of a color change, e.g. from green to red in the case of an alarm.

Symbolic library

All detector symbols (<DetectorName>.emf) can be found in the symbol library on the BIS server under:

c:\MgtS\Default_Configurations\Common\Documents\Symbols\2D or (...)\3D)

Around 150 prepared detector symbols (in two dimensional form) can be found in the 2D subfolder.

Blink modes for Detector symbols

The following settings are available (singly or in combination):

- Default Setting (Mode 1): The detector symbol's background color (state dependent) blinks.
- Special setting (Mode 2): The detector symbol's graphic and frame blink on a green background
- Special setting (Mode 3): The whole detector symbol blinks (frame, graphic and background color)

Differentiating between patterns

Modes	What is blinking?	Filename	Background color
Mode 1 (Default)	only background	<Detector Name>.emf	Green (RGB: 0,255, 0)
Mode 2	Frame and symbol graphic	<Detector Name>.emf	Green (RGB: 0,255, 0)
Mode 3	Whole detector symbol (Frame, Symbol graphic and background)	<Detector name>.cmf	Alternating green, e. g. blue***

***) Blue (RGB: 0, 0, 255) or an RGB color mix (however no color alternation can be configured for colors other than green.)

Changes in blink modes

In order to change a symbol's default blink mode (i.e. mode 1) to mode 2 or 3, make following changes:

- **To set blink mode 2** Change the file extension of the relevant symbol's file to .CMF (Corel Metafile), e.g. <DetectorName>.emf to <DetectorName>.cmf
- **To set blink mode 3:**
 - Change the file extension of the relevant symbol's file to .CMF (Corel Metafile).
 - Additionally, change the background color of this file (e.g. from green to blue)



Notice!

Color changes to detector symbols can only be carried out using vector graphic editors, such as Adobe Illustrator, not with raster graphic editors.

**Notice!**

If all blink modes are to remain available for this detector symbol, then any changes to Mode 2 and Mode 3 should be carried out on copies of the original files, taken from the symbol library.

**Notice!**

In order to use them, any new or modified symbols must be made available again in the symbol library folder:

C:\MgtS\Default_Configurations\Common\Documents\Symbols\2D

13.14**Application Launcher**

The application launcher provides a means of starting arbitrary housekeeping processes or applications from within BIS. The processes are always run:

- on the BIS Server
- as background processes (they do not appear in the Windows foreground)
- under the user **MgtS-Service**

Typical examples of applications you may wish to start in this way are data imports/exports, backups or deletions of accumulated report files.

Note: BIS already provides a means of starting arbitrary applications on-the-fly:

Device Overview > Devices > Application Launcher > Start > (right click for context menu) > Start Application

However, the advantage of pre-defining applications in the Configuration Browser is that they appear under user-defined names with pre-defined parameters and timeouts. Hence the end-user does not have to enter all these details on-the-fly.

Defining launchable applications in the Configuration Browser

1. Select the **Infrastructure** Outlook button, then click **Detector type**.

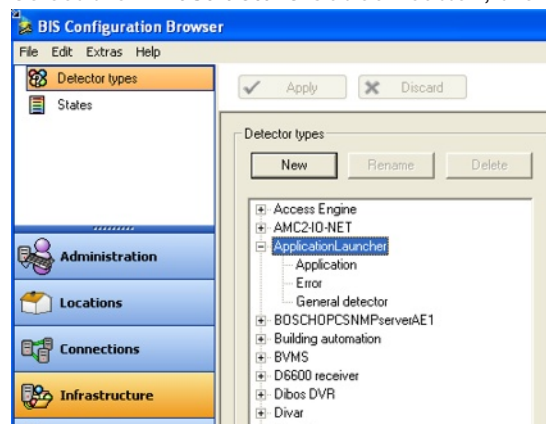

2. Click the Copy button to copy one of the template applications **Start application** or **Start configuration backup**. Give the application a new name (this example: **My New App**).
3. Then click the parameter button to define the following:
 - the command line to be invoked
 - a period of time in seconds (here 1hr = 3600 seconds) during which the started application will be monitored. If the application does not terminate normally within this period, an error message is generated.
 - a flag to determine whether the application should be terminated when the period has expired.

**Notice!**

If the boxes in column **Keep Macro** are left checked, then the application will automatically prompt for these parameters at run time.

1. The configuration must then be saved and reloaded in BIS, in order to become effective.
2. Thereafter the new application is available in BIS under: **Device Overview > Devices > Application Launcher > Start >** (right click for context menu)

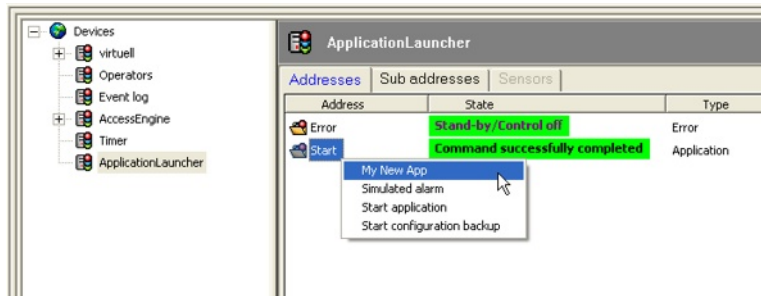
**13.15****Virtual device**

Use virtual devices to group detector points that have the same functions (for example, power failure detectors installed throughout a building).

Use the **Virtual device** Configuration Browser item to define the server-specific data for all connection types set up on the **Connections** Configuration Browser window.

Click here for more information on: *Connections and Addresses, page 135*

For each virtual device used, you can:

- Set the interface parameters
- Assign or browse to addresses

Configuring Virtual Devices

From the Configuration Browser, select the **General Settings** Outlook button, then click **Virtual device**.



This screen allows you to define virtual devices for procedures or line conditions which exist only as logical functions, but not as actual devices. They appear under the **virtual** component as elements in the device tree, and can be a part of different links.

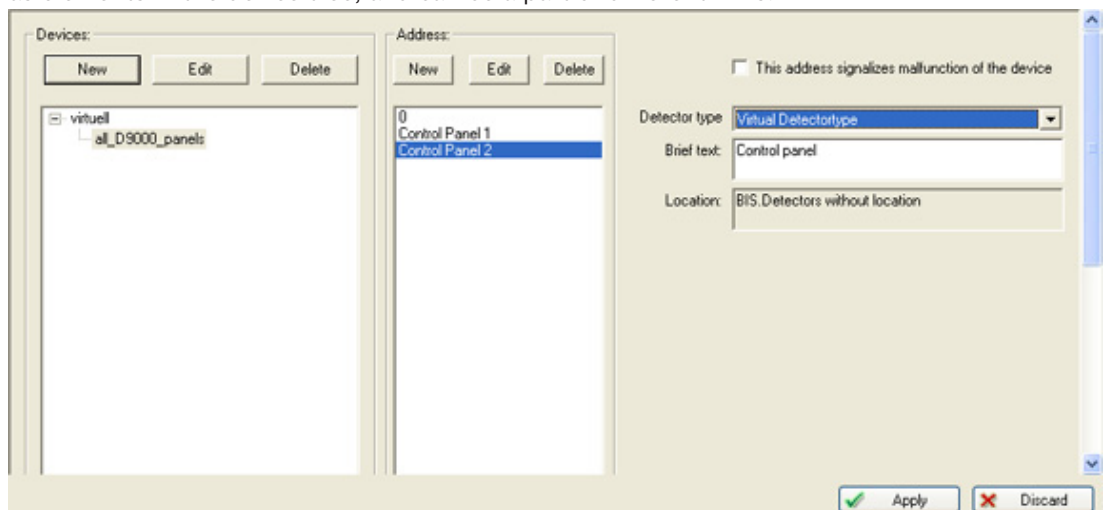

Select the Configuration Browser's **Locations** tab, then click **Detector placement**. Anchor the virtual data like a normal detector (for example, using hyperlinks in a floor plan).
 Click here for more information on: *Detector placement, page 141*

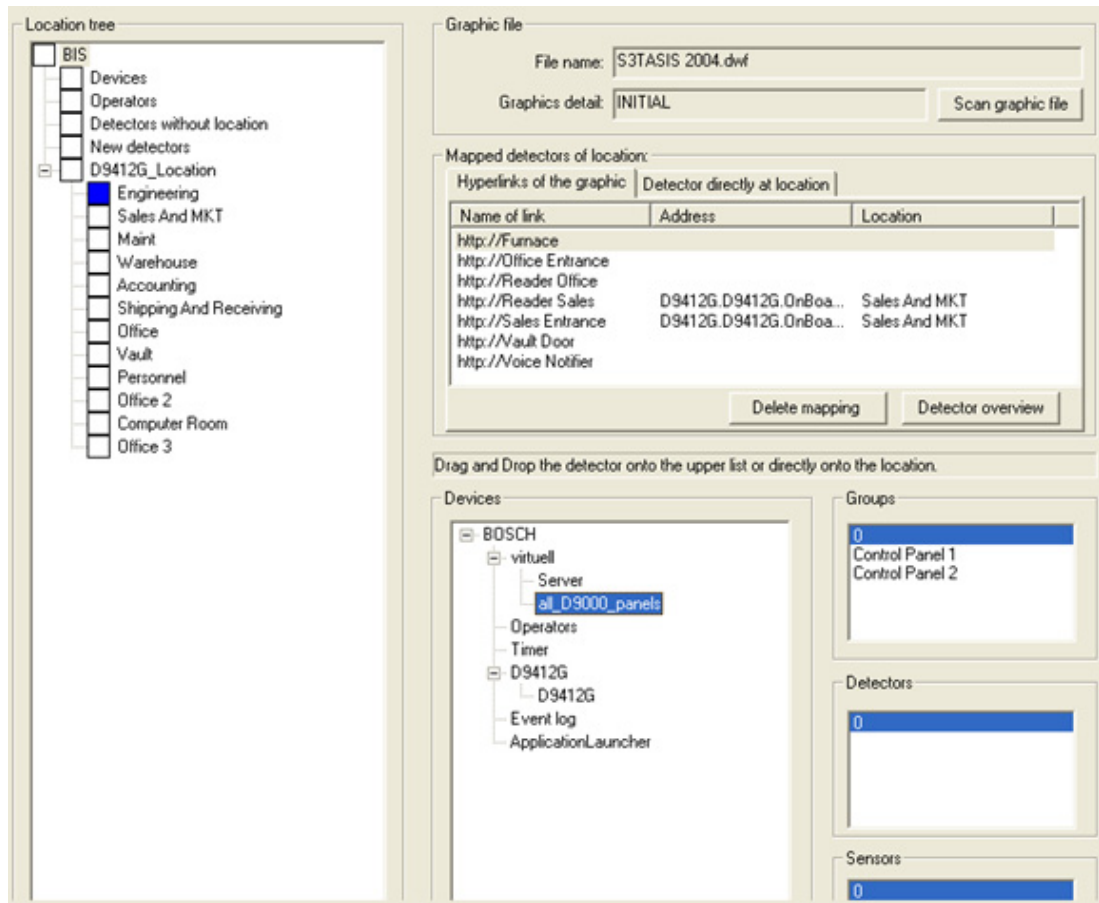

Select the Configuration Browser's **General Settings** tab, then click **Associations**. With associations, too, you can use virtual devices like genuine devices (for example, you can generate a message or configure a control process for a virtual device).

Click here for more information on: *Associations (Jobs) - an overview, page 173*

13.15.1

Example: Configuration of a Virtual Device

Configure a virtual detector that reports when all window contacts on the 1st floor are closed.

Preliminary steps for setting up the virtual detector

1. Select the **Infrastructure** tab in the Configuration Browser, then click **States**.



2. Define the required state list (for example, line condition 101 “1st floor mag contacts closed”), then click **Apply**.

State	Priority	Text	Audio	Used in lists
99	99	Condition 99	BISAlarm.wav	<not used>
100	99	Communication request	BISAlarm.wav	Communication, Control on, Intrusion
101	99	1st floor mag contact closed	BISAlarm.wav	Intrusion

3. Select the Configuration Browser's **Locations** tab, then click **Tree structure**. Create the location “1st floor” and link it to the corresponding floor plan. (Optional: The hyperlink to the virtual detector “All magnetic contacts” is inserted in the floor plan.)

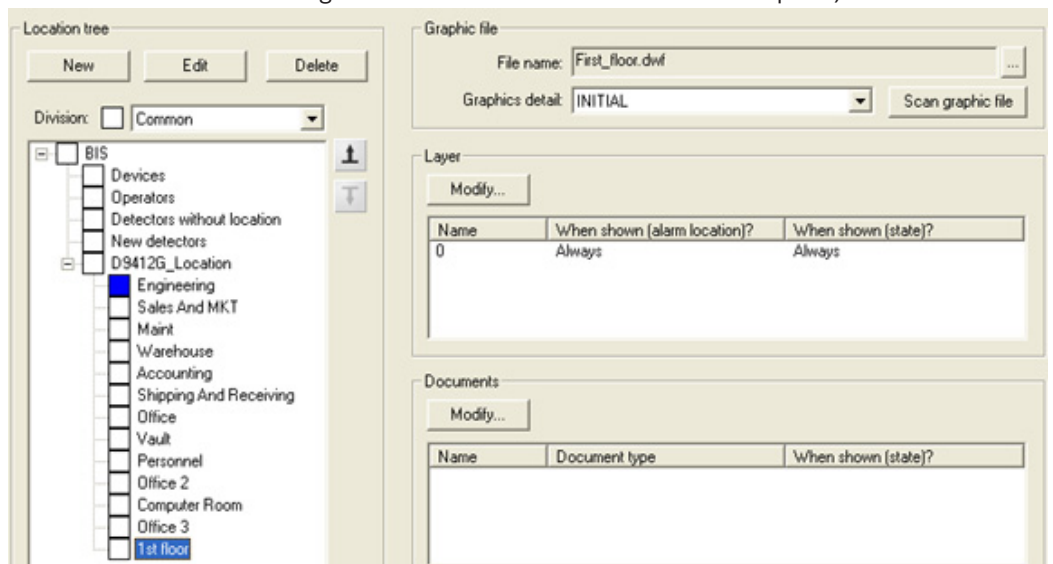

4. Select the Configuration Browser's **Infrastructure** tab, then click **Detector type**. Create and define the virtual magnetic contacts. As an option you could, for example, use the normal magnetic contact symbol for the virtual detector "All magnetic contacts", but emphasize it by making it extra-large when defining the hyperlink.

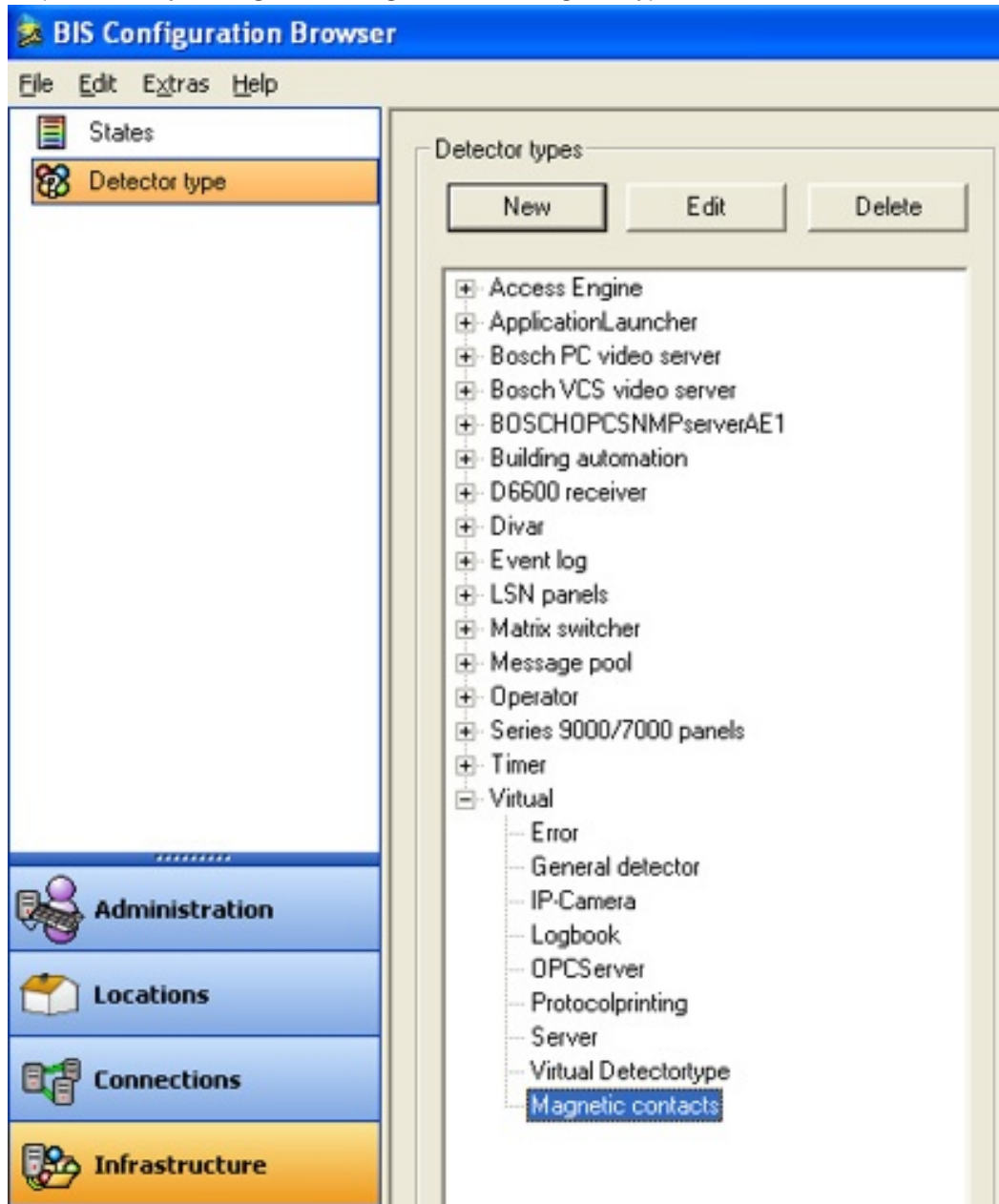

Procedure for setting up the virtual detector

1. Select the Configuration Browser's **General Settings** tab, then click **Virtual Device**.



2. In the **Devices** pane, click **New** to create a virtual device for the window contacts (for example, "All window contacts"). At this point, by selecting **Address -> New**, you can also set up "sub-addresses" with self-explanatory detector names (for example, "Contacts left corridor" and "Contacts right corridor").

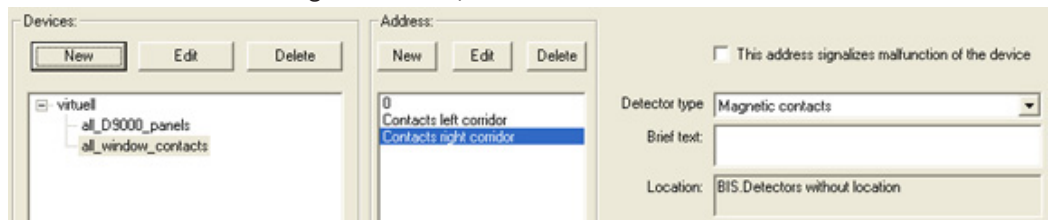

3. Select the Configuration Browser's **Locations** tab, then click **Detector placement**. The virtual device "All window contacts" is displayed on the right side in the device tree of the **Devices** pane as a virtual connection. If configured as described in the previous step, the

groups “Contacts left corridor” and “Contacts right corridor”, which can also be anchored with hyperlinks, appear.

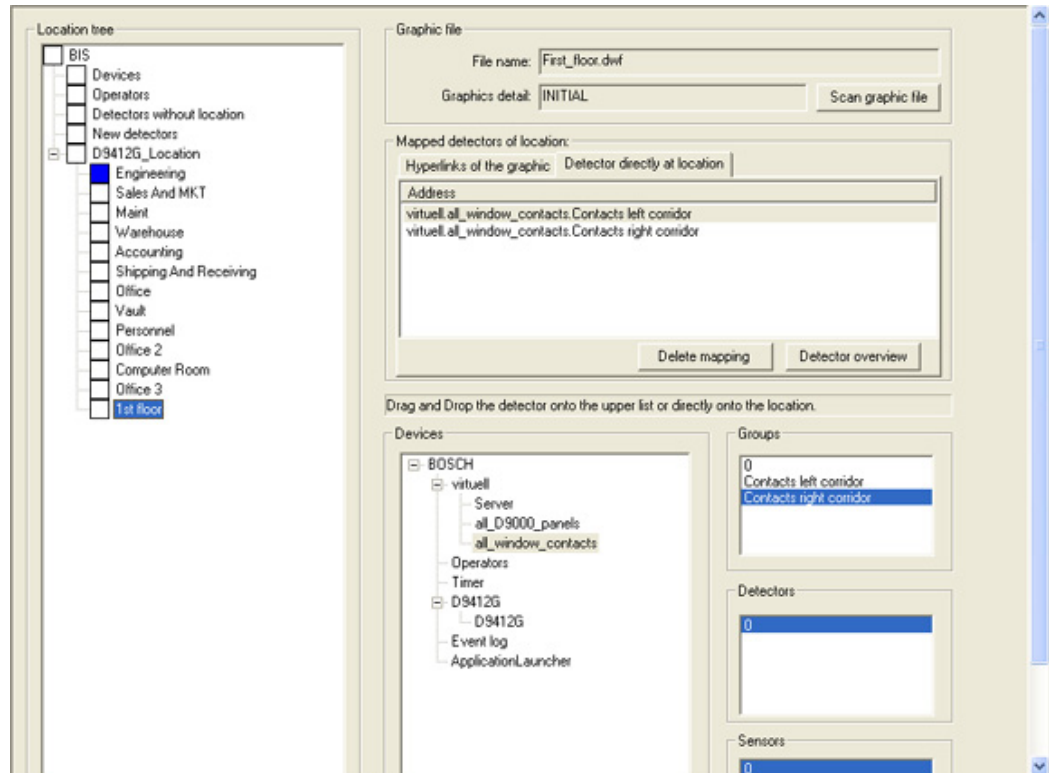

4. Choose the appropriate location from the location tree on the left hand side. The existing links of the location plan are listed automatically.
5. In the **Mapped detectors of location** pane, select the **Detector directly at location** tab. In the device tree below, select the virtual device **All window contacts**. Pressing the left mouse key, drag the whole device (or individual groups/detectors/sensors displayed alongside on the right) into the **Mapped detectors of location field**.

Using the virtual detector in an Association

In order to make effective use of the virtual detector for message-generation and system-control purposes, it can be embedded in an Association. Proceed as follows.

1. Select the Configuration Browser's **General Settings** tab, then click **Associations**.
2. Create a trigger and enter the virtual detector's address in the Address field.

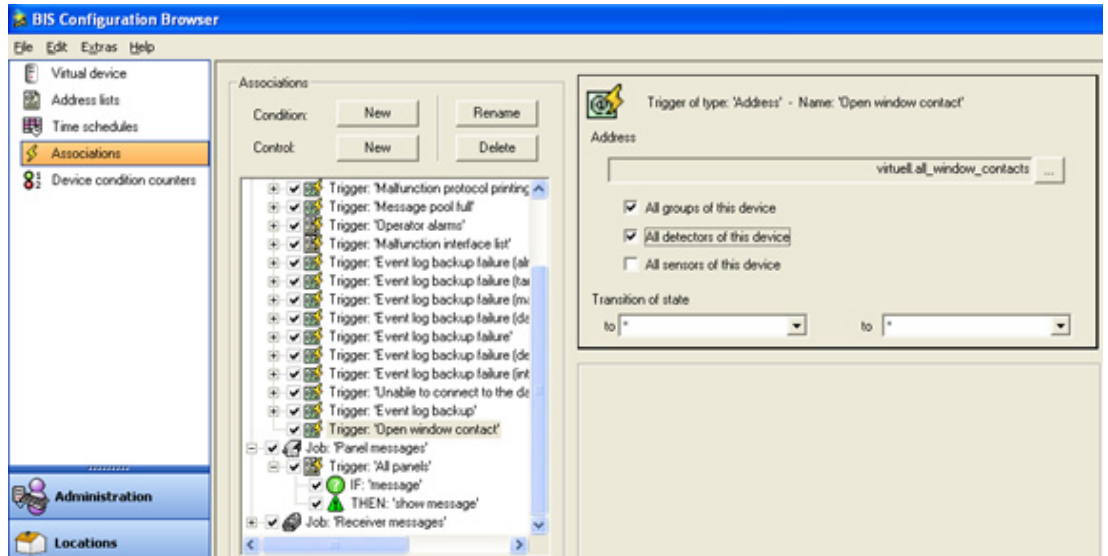

13.16 Address lists

Address lists are used for bundling addresses so that they can be manipulated as groups rather than individuals. This extra level of abstraction greatly enhances the power and effectiveness of the Building Integration System.

Examples of uses for Address lists

- To enable **Control Commands** to manipulate all the detectors in one part of a building, for example, all detectors on the third floor.
- To enable **Associations** to trigger on any events of a particular type.
- To enable the use of **Device Condition Counters**.
- To assign **Authorizations** over many devices at once.
- To unlock all ground floor doors at once, in the event of an emergency.
- To trigger print jobs or event log tasks

To define and modify Address lists, navigate to the dialog as follows:
 In the Configuration Browser select **General settings > Address lists**.



Orientation in the Address lists dialog

The main dialog for Address lists is divided into 3 panes:

- **Address lists:** (left side) contains the names of Address lists that already exist in the configuration.
 - **Detector addresses:** (upper right) displays the addresses that have been defined for the Address list that is currently selected in the **Address lists** pane.
 - **Addresses of the selected item** (lower right) displays details about the addresses that are currently selected in the **Detector addresses** pane.
- If an address range is selected in the **Detector addresses** pane then the individual addresses of that range are listed here.

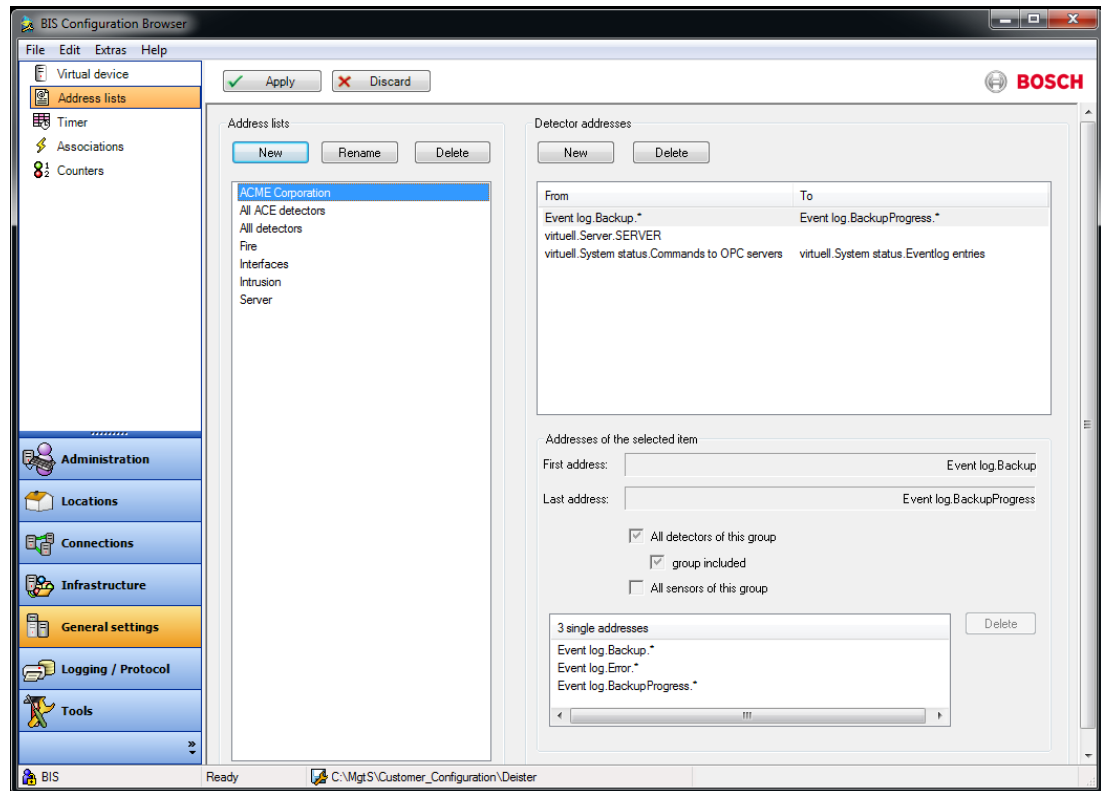

Creating address lists

1. Click the **New** button at the top of the **Address lists** pane, and overwrite the default name **Unnamed <integer>** with an appropriate name.
 - Click on the name to select it for filling.
 - Alternatively left-click one of the existing default address lists to select it for filling.
2. Click the **New** button at the top of the **Detector addresses** pane to invoke the **Address selection** dialog box.
3. When you have finished creating and filling address lists, click the **Apply** button to save them to your configuration.

Editing Address lists

The **Address selection** dialog box is a powerful tool for accumulating individual addresses and address ranges into an address list.

Selection of list items in general:

Left-click with the Shift key to select address ranges, that is multiple contiguous addresses. Left-click with the Ctrl key to select multiple noncontiguous addresses.

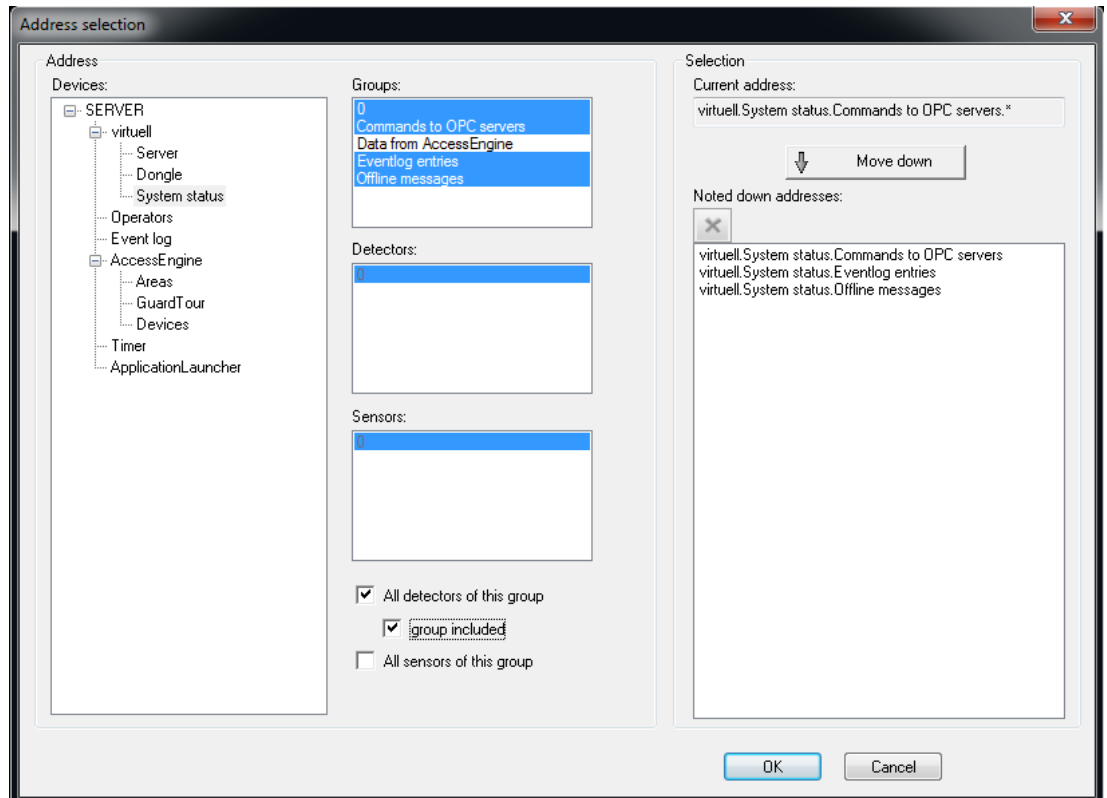

Procedure

1. Select addresses and address ranges from the **Devices** tree on the left, and then any required sub-items from the **Groups** and **Detectors** list boxes.
2. The optional check boxes are used as follows:
 - Select the check box **All detectors of this group** if all the detectors in the group are to be added to the address list.
 - Select the check box **Group included** if the group itself is to be added to the address list, not just its dependent detectors.
 - Note that the check box **All sensors of this group** normally has no function, because most OPC servers do not cover the level of sensors belonging to individual detectors.
3. Click the **Move down** button to add the currently selected addresses to a temporary storage buffer called **Noted down addresses**.
 - If required, continue with accumulating further addresses for the list
4. When all the addresses you require are accumulated in **Noted down addresses** click **OK** to store the address list.
5. You return to the main **Address lists** dialog, where you will see the accumulated addresses displayed in the **Detector addresses** pane.
6. Click the **New** button in the **Detector addresses** pane again to return to the **Address selection** dialog and accumulate more addresses. These will appear alongside the already accumulated addresses in the **Detector addresses** pane when you return to the main dialog.

NOTE: A single address can appear in multiple address lists.

Caveats for Address lists



Notice!

Use only alphanumeric characters in the names of address lists.



Notice!

Address lists are limited to 10,000 addresses each.



Notice!

An Address list can contain addresses and/or address ranges from several subsystems. For example, the detector groups 100 to 110 of subsystem UEZ1 and the addresses 60, 64, 67, and 69 of subsystem UEZ2.

See also

- *General procedure for configuring Associations, page 178*
- *Device state/condition counters, page 192*
- *Authorizations, page 118*

13.17

Timer

Select the Configuration Browser's **General Settings** Outlook button, then click **Timer**.



With Timers/time schedules you can define any program schedules you require. You can define up to four time slices (four periods) for each of the following:

- All days of the week
- Up to 30 **Extra days** (freely definable special days in your calendar)

All the time slices (time periods) of a scheduled program are considered together to determine whether or not a scheduled program should be active at a particular time on a particular day. Scheduled programs are often used in **Associations**.

Use the corresponding buttons to create, rename, or delete a scheduled program.



Notice!

The following characters are not allowed in Time Schedules: # < > ' " & * ? .



Notice!

Extra days have higher priority than weekdays. Therefore, if an **Extra day** falls on a Thursday, and if a scheduled program is configured for the **Extra day**, it overrides the scheduled program that would normally be active on the Thursday.

Procedure for Configuring Time Schedules

1. Click the **New** button to create a scheduled program (for example, “Banking hours”).
2. Select the **Week** tab and then highlight a day (for example, “Monday” to “Sunday”).
3. Enter times in the fields for time slices (“Time1” through Time4”), and then click the desired day of the week to transfer the time slice to that day.



Notice!

For a time schedule there are only 2 states:
 Timer on - only within the limits of the defined time slices.
 Timer off - the default state (field blank)

4. Copy and paste the time slices into the desired days of the week.

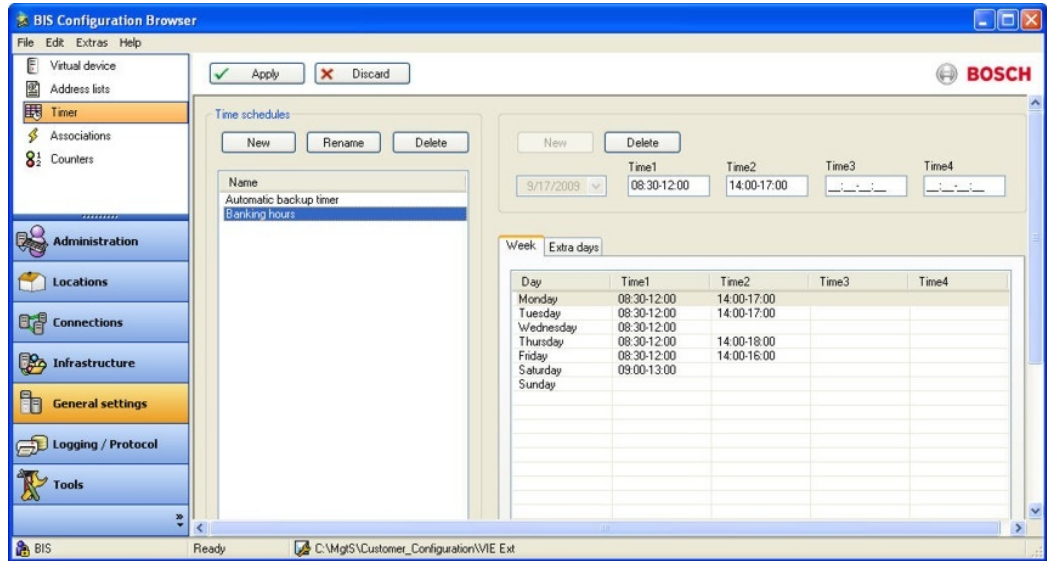

Notice!

Behavior in the case of overlapping or consecutive time slices.

If by mistake time slices are entered which either overlap or are exactly (i.e. to the minute) consecutive, then the system sets the timer to on from the earliest starting time to the latest finishing time of the time slices involved, e.g.:

	Time slice "Time 1"	Time slice "Time 2"	Time on (without interruption)
1	10:00-14:00	13:00-16:00	10:00-16:00
2	10:00-14:00	11:00-13:00	10:00-14:00
3	10:00-14:00	14:00-16:00	10:00-16:00
4	10:00-14:00	08:00-11:00	08:00-14:00

Select the Configuration Browser's **General Settings** tab, then click **Associations**. Configure the setup for this scheduled program so that, for example, alarms during the closed period are reported to a different point than during the open period.



Notice!

If you need more than four time slices per day, this can be done with a second time schedule.

Summer- / winter time

Winter time (02:00 becomes 03:00)

The change of the clock happens at 1:59:59:

- Time schedules starting at 2:00 will NOT be executed!

- Time schedules starting at 1:55 and ending at 2:30 will run effectively from 1:55 - 3:00 (approx. 5 min.)

Summer time (3:00 -> 2:00)

The clock shows 2:00:00 in the second after 2:59:59:

- A time schedule 2:15 -> 3:15 runs 1h longer. In the change 3->2 the time schedule does not end!
- A time schedule 2:05 -> 2:15 runs only once - after the change 3->2 the time schedules is not started for a second time.

13.18

Associations (Jobs) - an overview

Associations (also known as Jobs) are the IF-THEN rules which govern the behavior of the BIS system. When the BIS server is running its State Machine constantly monitors the states of connected devices, timers and messages, and matches them against all the Associations that are stored in the currently loaded configuration. Whenever one of the **TRIGGERS** of an Association is fulfilled, then the State Machine executes that Association. First it checks that all additional prerequisites (i.e. the **IF** clauses) are fulfilled, and if so, carries out the commands in the **THEN** clauses. Otherwise it carries out the actions in any **ELSE** clauses that the Association may have.

The key elements in an Association are therefore:

- Triggers (preconditions linked by a logical OR)
- IF clauses (additional conditions, linked by a logical AND). **Note:** IF clauses are optional, because Triggers by themselves can play the role of preconditions for the Association.
- THEN clauses
- ELSE clauses

The effects of an Associations (i.e. the THEN and ELSE clauses) can be to change line states, create messages, set timers, set variables or send commands to devices. These are described in more detail below.

To create an Association, select the Configuration Browser's **General Settings** tab, then click **Associations**.

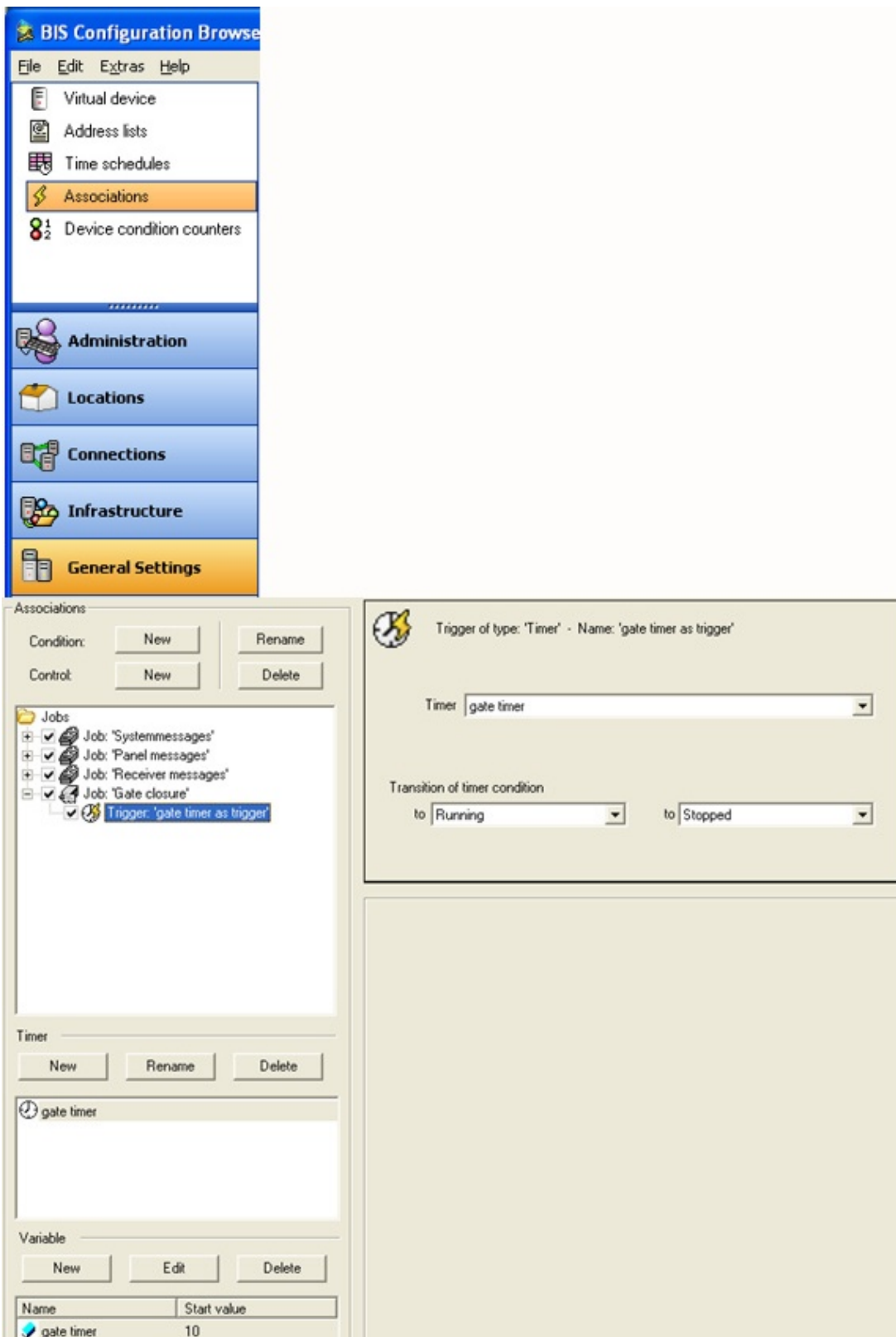

13.18.1 Elements of Associations

1. Job:

Job is the generic term for a particular task (Job is basically a synonym for the **Association** itself). The job may contain one or more “triggers” which serve in a logical OR as the prerequisites for performing that job/task.

For example, the job “monitor parking lot” could contain the triggers “car entering”, “car leaving” and “gate closure”. In this example any of the triggers can fulfill the prerequisites to perform the job “monitor parking lot”.

2. Trigger:

A trigger is an initial precondition for a job. It can be fulfilled by a state change in an address, address list, message or timer.

Parameters of triggers:	Possible state transitions:
Explicit addresses of connections	Any state to any other state
Address elements of Address Lists	Any state to any other state
Timers (measuring, for example, the time taken by individual steps in message processing)	Running to Stopped Running to Time Out
Message states	Possible states: – Not yet delivered (for example, a message is created but nobody is logged on) – Delivered (but not yet accepted) – Accepted (but not deleted) – Workflow messages (not yet sent) – Deleted See the table below for possible state transitions.

Some notes on Timers:

- Timers are created by clicking the **New** button in the Timer pane. The default name is “Unnamed”, followed by “Unnamed 1”, “Unnamed 2” etc. to a maximum of “Unnamed 999”. Bosch recommends that the defaults be replaced by more meaningful names, to avoid reaching the numbering limit.
- The maximum timer value is 2147482 sec, which is almost 25 days.
- Timers are not assigned any time value (for example, “10 seconds”). You must configure a start and/or end value.
- Variables and timers are local to their jobs. They do not affect other jobs, and Job X can not make use of variables defined for job Y.

The following table shows which message state transitions are possible (**yes**) or impossible (**no**).

State Change	TO:	New (Not Delivered Yet)	Delivered (New or Workflow)	Accepted (Acknowledged)	Workflow (Not Sent Yet)	Deleted	Timeout

FROM:							
New (Not Delivered Yet)		no	yes	no	no	no	yes
Delivered (New or Workflow)		no	no	yes	no	yes	yes
Accepted (Acknowledged)		no	no	no	yes	yes	yes
Workflow (Not Sent Yet)		no	yes	no	no	no	yes

3. IF clause

Triggers can be made more precise by adding IF clauses to them. IF clauses are optional, because the triggers themselves can serve as preconditions.

- **IF** (additional condition): If multiple IFs are used, then they are linked by a logical AND. A trigger can have multiple AND-linked conditions. For OR-links, use multiple triggers. The trigger is only fulfilled if all its IF conditions are met. The following table summarizes the scope of IF clauses.

Parameters of IF clauses	Possible status values	Possible comparison operators
Explicit address of connections	All line states	=, !=, >, >=, <, <= (equals, does not equal, greater than, greater than or equal to, less than, less than or equal to)
Variable	Any positive decimal values	=, !=, <, <=, >, >=
Attributes (that is, values additionally supplied by the OPC server, such as ADI in the case of LSN)	-Delete -Report -Do not delete -Do not report NOTE: You can also create custom attributes.	=, !=

Example: **ADI** (ADI Advanced-Display-Information (DPI Display-Print-Information) in the case of LSN)

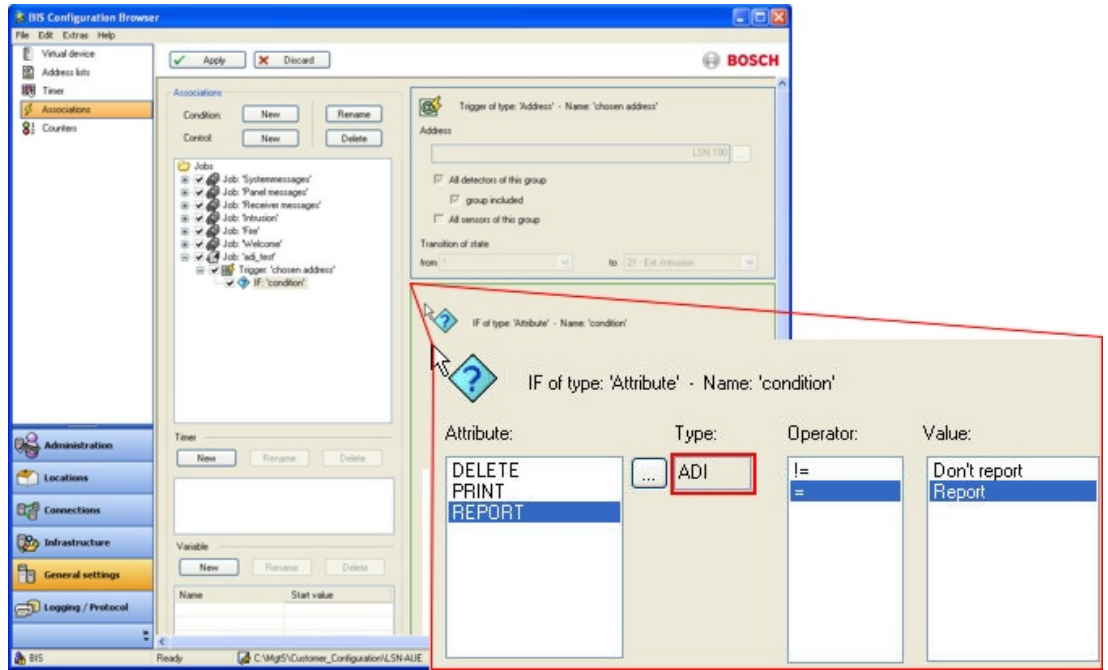

4. THEN clause

- **THEN** (= control/action): If multiple THENs are used, then they are executed in the order listed. The performance of these control operations is logged.
You can assign the following in a THEN clause:

Parameters that can be the object of a THEN control operation	Possible control operations (examples)	Possible parameters for the evaluation
Explicit addresses of subsystems	Building control, Set temperature	=, !=, <, <=, >, >= (for example, >= 80)
	Video matrix Zoom In/Zoom Out	Number of steps
	LSN Reset	A state (aka line condition)
	Block LSN	ON/OFF
	LSN sensor functionality check	ON/OFF
All elements of an Address List	See above	See above
Message	Generate	Alarm address
		Alarm status
		Time Out per user status
Timer	START	Time Out
	STOP	-----
Variable	SET (set to)	Decimal value

ADD (Add)	Decimal value
SUB (subtract)	Decimal value
MULT (multiply)	Decimal value
DIV (divide)	Decimal value

5. ELSE clause

- **ELSE (= alternative control/action):** These are executed in the order listed whenever the trigger is fulfilled but the IF conditions are **not** fulfilled. Their objects, control operations, and parameters, are the same as for THEN clauses.

Activation/deactivation of state machine associations

For testing or maintenance purposes, it is possible to activate or deactivate elements in the Association tree by selecting the check box field in the tree. The check box fields in the Association tree have three states:

- = The element and all child elements are active.
- = The element and all child elements are NOT active.
- = The element itself is active, but there are one or more deactivated child elements.

13.19

General procedure for configuring Associations

For each association/job, adhere to the following general procedure:

1. Create the job and give it a meaningful name (for example, “Door control”).
2. (Optional) In the **Timer** field, create any timers required and give them meaningful names.
 - ▶ (Optional) In the **Variable** field create any variables and give them meaningful names.
1. (Required) Select the job, create a trigger, give it a meaningful name, enter the parameters, and enter useful comments in the comments field.
2. (Optional) Select the trigger, create one or more “IF”-clauses; give each a meaningful name using the comment field, and enter the parameters.
3. (Optional) Select the trigger, create one or more control clauses (THEN and ELSE), give each a meaningful name using the comment field and enter the parameters.

Right-click nodes in the tree of links in order to do the following:

- Copy and paste statements
- Disable statements, including parts of statements for test purposes, which can then be used again later

Recommendations

- Use Address Lists and State Lists as much as possible. This can considerably reduce the amount of copying and pasting required. See *Address lists, page 167*
- Give descriptive names to the individual elements of an association, to make them easier to debug.



Notice!

The BIS state machine takes account of supervision addresses when processing Associations: If, for example, an address goes into a state X that triggers an Association, and if that address signals the same state X after having signaled a malfunction on the supervision address in the meantime, then the BIS state machine recognizes that state X was the last valid state before the malfunction, and does not trigger the Association again for the same address.

For more details on defining Associations see *General procedure for configuring Associations*, page 178

13.20 Message timeouts, distribution and escalation

Messages can be created in **THEN** or **ELSE** clauses of **Associations**.

THEN of type: 'Message' - name: "

Use alarm address

Monitored by camera

Use alarm state

Timeouts

Messages in condition "Not delivered": [s]

Messages in condition "Delivered": (New- or workflow stack) [s]

Messages in condition "Accepted": [s]

Workflow messages (not yet delivered): [s]

Distribute messages to

all permissions

only following permissions

Selection	Authorization	Timeout	Authorization
<input type="checkbox"/>	AdminNoLiveVideo	30	Administrator
<input type="checkbox"/>	AdminNoVideoRepl...	30	AdminNoVideo
<input type="checkbox"/>	Operator		

Timeouts

Message timeouts can be used to react automatically if a message is not delivered, or not processed by an operator, within a specified time.

Timeouts provide a means of triggering a follow-up alarm, for instance at a higher priority or with additional acoustic signals, if there has been insufficient reaction to the original alarm.

Defining a timeout

- In the **Timeouts** panel, select one or more of the message conditions on which to react, and enter a timeout period in seconds.

- **Not delivered:** no-one who could process the message is logged on
 - **Delivered:** the message is in the queue in condition **New**
 - **Accepted:** the message has been accepted but not deleted
 - **Workflow not yet delivered:** the message is in condition **Workflow**, but no-one with the required authorization is logged on.
 - Timeouts start counting seconds as soon as the state change that caused the message is detected by the BIS State Machine.
 - After the time has elapsed the condition of the current message is set to **TimeOut**
- Note:** These timeouts are unrelated to timeouts in the escalation process, compare *Message escalation, page 180*

Using a timeout

- For example, create a new trigger of type **Message** that reacts when the condition of a message is set to **TimeOut**.

Message distribution

By default messages are sent to all Authorizations immediately. You can change this by selecting of the radio button **only following permissions** in the distribution panel.

- As soon as they are generated messages are sent immediately to all authorizations whose check boxes are selected in the left panel.
- If no authorization is selected, the message is escalated after a few seconds to a potential receiver in the right hand panel. **Note:** In this case the timeout period in the right panel is ignored.
- If one or more authorizations are selected, or if the radio button **all permissions** is selected, but no one accepts the message, then the message may be escalated as follows:

Message escalation

- The right hand panel defines the times and order of further message escalations and is to read from top to bottom:
- The message will be sent after [Timeout] seconds to the [Authorization] specified

13.21 Examples of Associations

This section contains examples of useful Associations.

13.21.1 Example of tracking totals using Associations

In an underground car parking garage with 100 parking spaces, a light barrier detects each car as it enters. When a car drives through the light barrier, the message “car entering” appears in the porter's office. If there are 100 cars in the underground parking garage, the message “garage full” is output.

A. Preparing to configure Associations

- The required states, such as 090 “car entering” and 091 “garage full” must be defined in the **States** Configuration Browser item.
- The location “underground garage” must be created in the **Tree structure** dialog and is linked to the corresponding floor plan. The hyperlink to the detector “light barrier” is inserted in the floor plan.
- The light barrier is created and defined as a detector in the **Detector Type** dialog.

- In the **Detector placement** dialog, the light barrier is assigned as a detector in the floor plan.

B. Setting Up the Association

1. From the Configuration Browser, select the **General Settings** tab, then click **Associations**. Click **Job:New** to create a new job called “Underground garage”.
2. Click **New** or the right mouse button to create a trigger. Specify under **Type** what the trigger will respond to. In this case it is the light barrier, so select **Address**. Enter an explanation in the **Comments** field, such as “light barrier”.
3. From ensuing the device tree select the appropriate detector (the light barrier's address). The **Trigger of address type** is then displayed on the **Associations** page.
4. Define the other parameters of the trigger. Select the check box **All sensors of this device**, since there is only one detector, and enter the line condition change. In this case, the change from OLD = 005 STANDBY to NEW = 090 CAR ENTERING.
5. Every time the light barrier responds, a count (equal to a control operation) takes place, so a THEN clause must be inserted in the trigger, and a variable entered as the object of this control operation. This variable is usually set up **before** the trigger is configured. Go into the **Variable** pane and click **New** to set up the variable for the car count. Enter a name, such as “Counter variable” and a starting value of “0”.
6. Insert the THEN clause by clicking the **Control: New** button, or right-click in the trigger. Select **Variable** as the object, and in the comments line enter an explanation describing the THEN clause (for example, “car count”).
7. Define the THEN clause in the **THEN of 'Variable' type** field by selecting the variable “Counter variable” and giving the instruction **ADD** for the desired control operation (in this case, add the variable value). In the **Value** field, state by how much to increment the counter (in this case, a value of “1” for each incoming car).
8. The progress of the counter variables is checked using an IF element which you must insert in the trigger. Because you must always set up the trigger sequence according to the IF -> THEN -> ELSE pattern, and the trigger “light barrier” already starts with a THEN clause, you must create a new trigger for the IF element.
9. Click on the job (in this case, “Underground garage”), and then right-click to create a new trigger with the already-known address of the light barrier. In the comments line, enter a description for the trigger, such as “check variable”.
10. Add the IF element (by right-clicking or by using **Condition -> New**). Select the **Variable** option of the object and, in the comments line, enter a description for the IF condition, such as “end value reached”.
11. Define the IF element in the **IF of 'Variable' type** field. Select the corresponding variable (in this case: “counter variable”), enter a **comparison operator** (in this case, “=”) and a **value** (in this case, enter “100” as the end value representing the capacity of the underground garage).
12. Click the element **IF: End value reached** and right-click to create a THEN clause of **Message** type, because a message should be generated when the condition “Variable = 100” is met.
13. Define the THEN clause in the **THEN of 'Message' type** field by selecting the **Use alarm address** check box and, for **Line status**, not selecting the check box **Use alarm status**. Instead, from the list field on the right, select the status which you defined: 091 GARAGE FULL.
14. Click the THEN clause and right-click to insert an ELSE element of **Message** type, so that, as long as the variable check does not produce the end value = 100, the message “car entering” appears in the porter's office.

15. Define the ELSE element in the **ELSE of 'Message' type** field by selecting the check box **Use alarm address** and, for **Line status**, not selecting the check box **Use alarm status**. Instead, from the list field on the right, select the status which you defined: 090 CAR ENTERING.

C. Summary of Steps

The “Job: Underground garage” example consists of the following logical configuration steps:

1. **First trigger:** Status transition (change) at the light barrier.
2. **THEN:** Car count (with the help of a predefined variable).
3. **Second trigger:** Check changes to variable.
4. **IF:** End value reached.
5. **THEN:** Message “Garage full”.
6. **ELSE:** Message “Car entering”.

Click here for more information on: *Message timeouts, distribution and escalation, page 179*

13.21.2

Example of configuring a security system using Associations

Requirement:

A Security System (SecSys) must already be configured.

First Association:

For all status changes reported by the SecSys containing the display/print information "Report", a message should display at the BIS user interface.

1. Create a new job with the name “SecSys-Messages”.
2. Create a new trigger of **Address** type called “SecSys”.
3. In the device tree, select the SecSys and then the option **All detectors of this device** and **All groups of this device**.
4. Create a new condition of object type **Attribute** called “ADI Report”.
5. Select the attribute **REPORT**, the comparison operator = and the value **Report**.
6. Create a new control operation of object type **Message** called “Message” and leave all settings at their default values.

Second Association:

When a SecSys message is acknowledged, a corresponding acknowledgement telegram is generated automatically and sent to the SecSys.

1. Select the job “SecSys messages”.
2. Create a new trigger of **Message** type called “Message acknowledged”.
3. For the message status **NEW** select **Acknowledged**.
4. De-select the check box **Any Address** and select the SecSys in the device tree.
5. Select the option **All detectors of this device** and **All groups of this device**.
6. Create a new control operation of object type **Address** called “Acknowledgement telegram”.
7. Select the command **SecSys: Acknowledge**. Do not make further entries.
8. Click **OK** to confirm your selection.

Third Association:

When a SecSys message is deleted, a corresponding deletion telegram is generated automatically and sent to the SecSys

1. Select the job “SecSys messages”.
2. Create a new trigger of **Message** type called “Message deleted”.
3. For the message status **NEW** select = “deleted”.
4. De-select the check box **Any Address** and instead select the SecSys in the device tree.

5. Next, select the option **All detectors of this device** and **All groups of this device**.
6. Create a new control operation of object type **Address** called "Deletion telegram".
7. Select the command **SecSys: Delete**. Do not make further entries.
8. Click **OK** to confirm your selection.

Fourth Association:

One-click user alarm with automatic acknowledgement.

1. Insert a virtual detector in the configuration client (for example, "User alarm").
2. On the **Detector placement** page, assign the virtual detector created above ("User alarm") to a desired location (or place it in a graphic).
3. Use FrontPage to insert an action button on the interface HTML page.
4. On the properties page of the action button, state the name of the button ("User alarm").
5. Select the command "Virtual. Set status with event attribute" and add it to the button command to be executed. Replace both parameters:
Status: desired message status
Event attribute: AutoAcknowledge
Do not change or replace any other parameters.
6. Enter the address of the virtual detector created above (for example, "virtual user alarm").
7. Select the authorizations which may process this message.
8. Do **not** set the properties "Mandatory" and "Parameters from message".
9. Close the properties dialog of the action button and save the HTML page.
10. Using the Configuration Browser's **General Settings** tab, select **Associations** and create a new job "User alarm".
11. Create a new trigger of **Address** type called "User Alarm Message", and select the virtual address entered above ("virtual user alarm").
12. For the line status **NEW**, select the status entered above as the action button status to send.
13. Create a new control operation of object type **Message** called "Message" and leave all settings at their default values.
14. Create a new trigger of **Message** type called "User alarm deleted".
15. For the message status **NEW**, select = "deleted".
16. De-select the check box **Any address** and instead select the virtual address in the device tree (for example, "virtual user alarm").
17. Create a new control operation of object type **Address** called "Standby status".
18. Select the command **virtual: set status** with state "5" (= "standby").

13.21.3

Example of automatic backup of the event log using Associations

Requirement:

The state machine must automatically trigger the backup of the event log.

Important decisions regarding automatic backup of the Event Log

- At what time should the backup automatically start?
- Into what directory should the event log be copied?
- What is the maximum number of backups that should be stored?



Notice!

Old backups are not deleted or overridden automatically. They must be saved and deleted by the administrator. If the maximal number of backups is reached, BIS generates an error message.

- Should the stored entries be deleted from the event log database?

Requirements when configuring the automatic backup of the Event Log

Create Time Schedules

1. Select **Time schedules** in the Configuration Browser.
2. Create a new time configuration (for example, **Time schedule automatic backup**).
3. Add the time spans (**weekly** or **extra day**) identifying when the backup will start.

Create Association for Starting the Automatic Backup

1. Select **Associations** in the Configuration Browser.
2. Create a new job (for example, **Backup**).
3. Create a new **Address** trigger. Select the **Timer** device and the **Time schedule automatic backup** group.
4. In the **Transition of state** field, select **OLD: (266) Timer off** and **NEW: (265) Timer on**.
5. Create a new **Address** control. Deselect **Use alarm address** and select the **Event log** device and the **Backup** group.
6. In the command list, select **EventLog.Start backup**. Fill the fields **Targetpath**, **Number of backups**, and **Delete entries**.

13.21.4

Example of an Association using “monitored by camera”

“Monitored by camera” is a feature within Associations that allows camera images to be displayed in the BIS GUI (“Miscellaneous Documents”) in response to alarm events.

Prerequisites:

There needs to exist an OPC connection to a camera device. See *Creating connections and addresses by browsing*, page 136

Note: The BIS Video Engine (VIE) is NOT a prerequisite.

Procedure

1. Click Outlook bar: **Locations > Tree Structure**. Define a frame document within which the camera images are to be embedded. This document should be assigned to the location of the camera hardware, or to a superordinate node in the location tree. In this simple example, the frame document is defined for the root node “BIS” of the location tree, and inherited by all subordinate locations. See *Assigning action plans and miscellaneous*

documents to nodes in the location tree, page 133

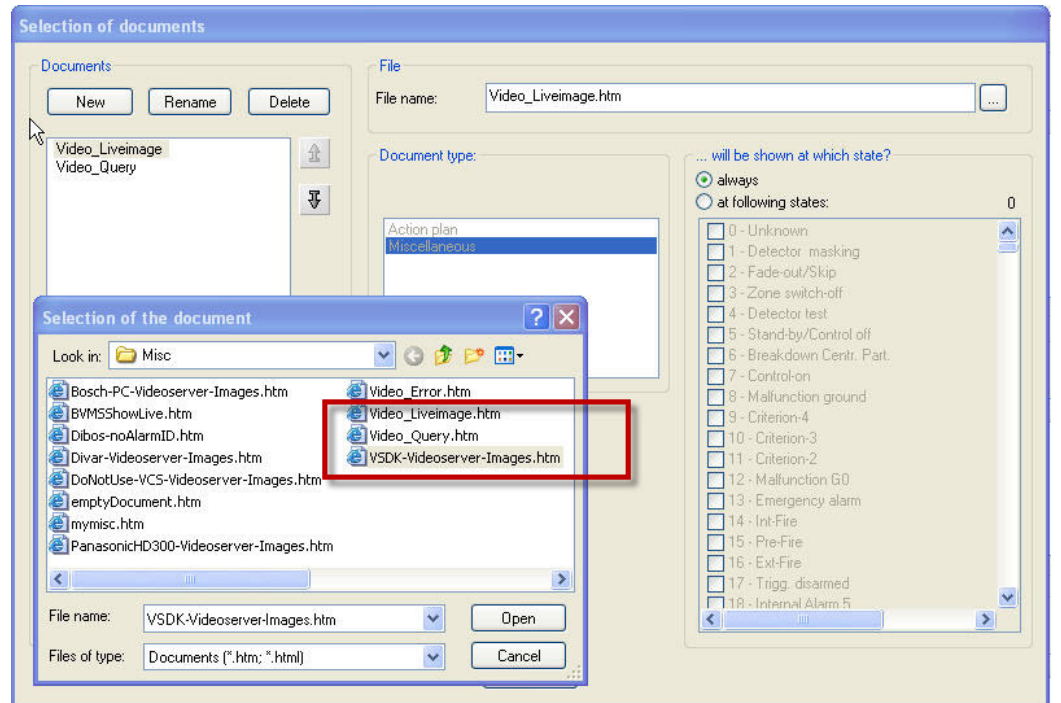
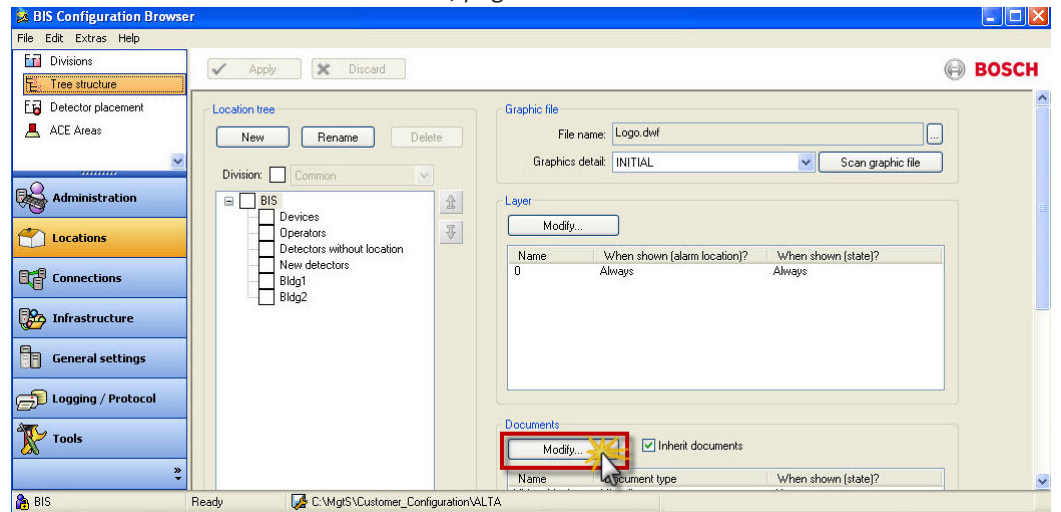

Notice!



There are a number of Miscellaneous Document templates, depending on the types of video device used, and their respective capabilities. In this example we have chosen the **VSDK-Videoserver-Images.htm** - a template which simply displays video streams. If you wish to include controls for stopping and replaying archived videos, then choose the template **Video_Query.htm**.

- Define or select a device on which to trigger an alarm event. For this example we have used a virtual device called Contact1.

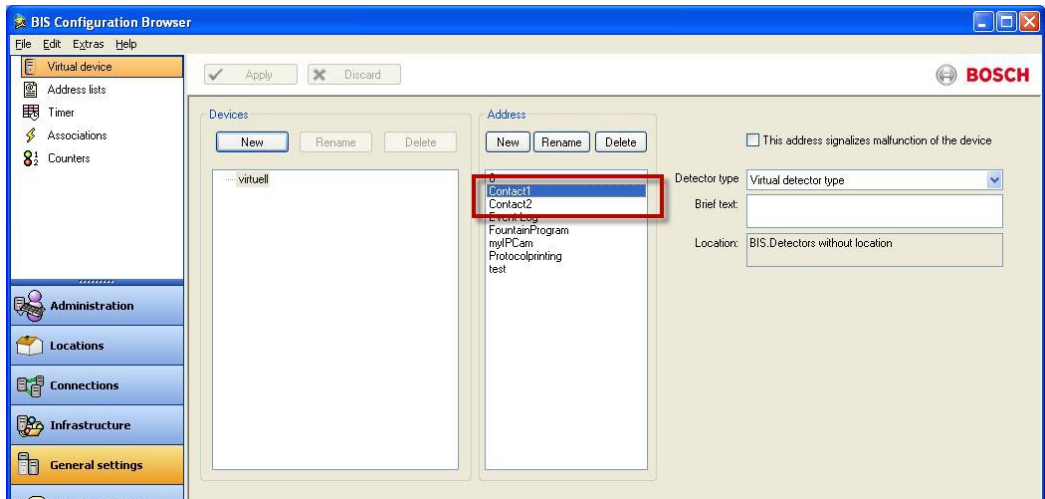

- Create a new Association with a trigger that reacts to a state change on Contact1. In this example the Association is called “Monitor Contacts” and the trigger is called “Show Message with Cam1”. This example trigger reacts to any state change, i.e. from “*” to “*”.
- Create a new THEN clause on the same trigger select the check box **Use address of trigger**.

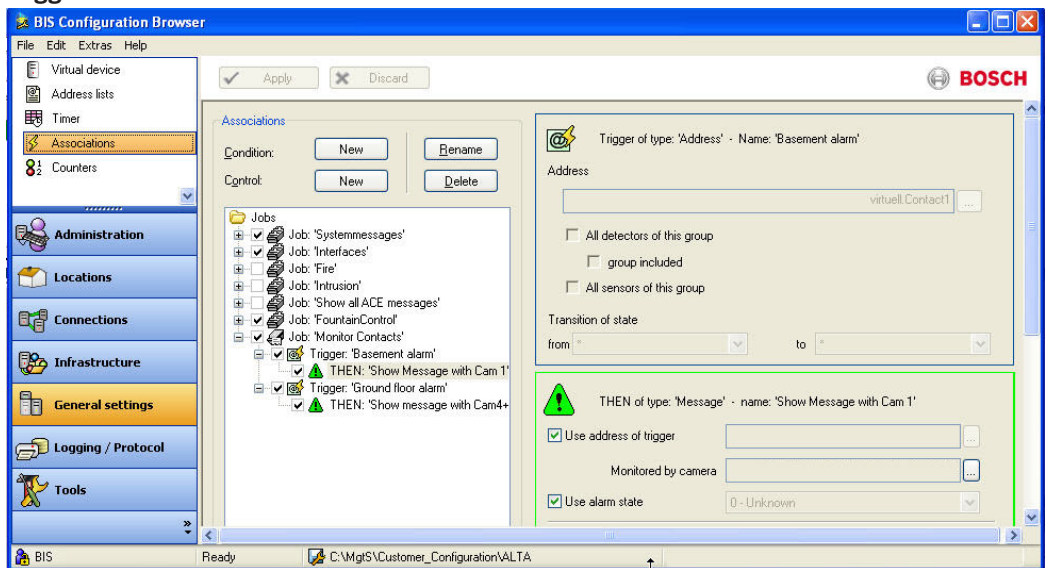

- Note: The next illustration enumerates the mouse-clicks (1) to (5) for steps 5 and 6. Click the file selection button labeled “...” (1) to bring up the **Selection of Camera** dialog. If the file selection button is not active it is likely that no camera device has been configured as an OPC connection (see Prerequisites of this section).

- In the **Selection of Camera** dialog, select the desired video device in the **Devices** pane(2), and the camera in the **Groups** pane (3). Then click the “<” button to transfer that camera device into the list box in the **Camera** pane (4). Confirm with **OK** (5).

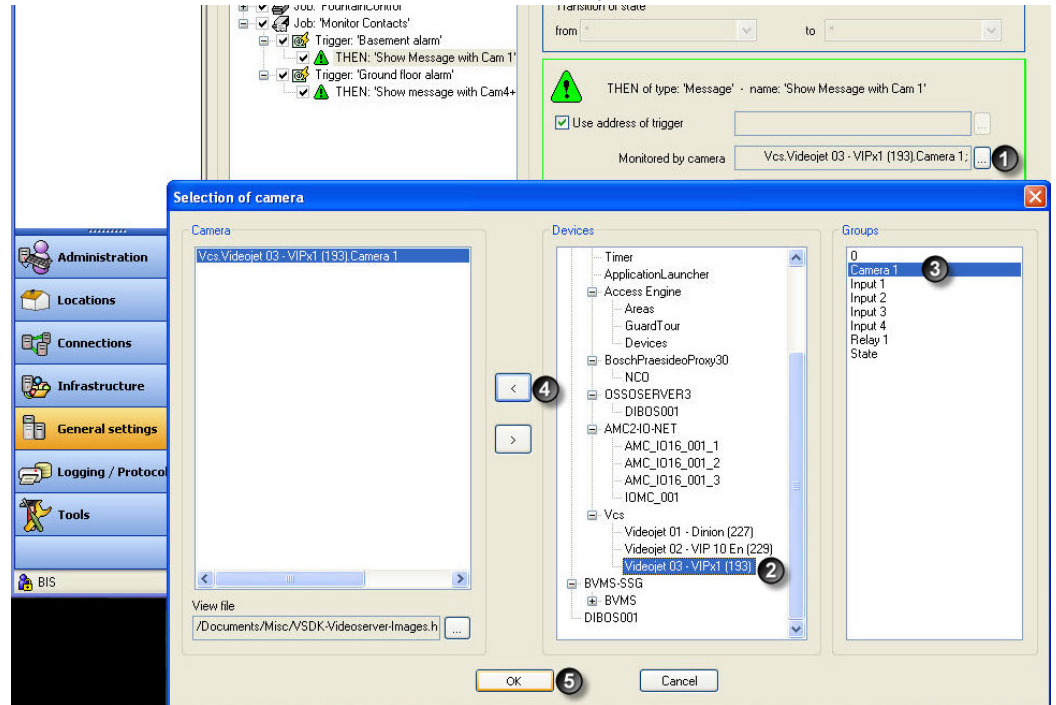

- Back in the Associations dialog, click the **Apply** button to save the changes, and then reload the configuration.
- Log on to a BIS client running this configuration. If a state change occurs on Contact1 the new Association generates an alarm. If this alarm is accepted by the operator then the miscellaneous document will be displayed containing the video stream defined in steps 5 and 6.

13.22 Backing up the configuration

Backing up the configuration manually or automatically (i.e. using Associations)

Prerequisites:

- The examples described below will only work if Timer functionality is licensed for your installation.

Important decisions to be made prior to backup:

- Where (in which directory) should the backed up files reside?
- What is the maximum number of backups to be retained?
- (For automatic backups) On which day(s) and at what time is the backup to be performed

Manual Backup



Note: The numbers in brackets refer to the numeric markers in the screenshots.

1. In the Device overview (1) of the Configuration Browser select **ApplicationLauncher** (2)
2. Open the context menu of the address Start (3).
3. Select the command **Start configuration backup** (4). The dialog box **Parameter entry** opens.

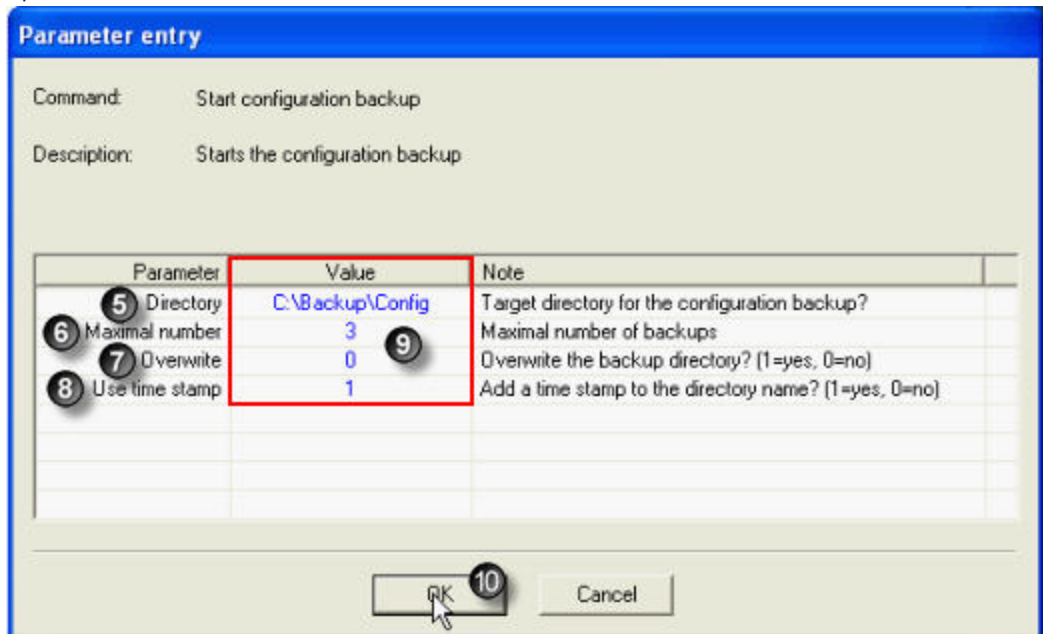

- 4.
5. In the Value column (9) set the following parameters:

- The target **Directory** for the backup (5).

Notes:

- a) The directory path must be an absolute and not a relative path
- b) If the directory path contains spaces, then the whole path should be enclosed in double quotes
- c) Mapped network drives should not be used, because the Application Launcher runs under a different account with possibly different drive-mappings.

- The **Maximum number** of backups to be stored (6).

Notes:

- a) This parameter is only effective in combination with a time stamp (8)
 - b) In order to create backups at all this number must be ≥ 1
 - c) If **Maximum number** would be exceeded by the next backup, and if **Overwrite mode (7)** is on, then the oldest existing backup is deleted when the next backup is begun.
 - d) If there already exist more backups than the maximum number N, and if **Overwrite mode (7)** is on, then, when the next backup is begun, BIS deletes **the newest of those backups which pre-date the N latest backups**. BIS also generates an error requesting that all backup directories be manually archived or deleted that pre-date the N latest backups.
- **Overwrite mode(7)** on=1, off=0
- Notes:**
If **Overwrite** mode is off, and if the maximum number of backup directories already exists, then, when the next backup is begun, an error is generated and no backup is written.
- **Use time stamp (8)**. Set value = 1 to ensure the target directory name includes a time stamp. (8). A time stamp is necessary in the directory name to distinguish between multiple backups.
- Notes:**
Therefore if this parameter is set to 0 then the number of backups can only be 0 or 1.
6. Check your entries and close the dialog with OK (10).
 7. Once the process is complete, the tool tip for the Start address will read **Command successfully completed** in the Application Launcher (11).



Automatic (scheduled) Backup

This example covers the configuration of a scheduled automatic backup, based on a timer. There are however a number of scenarios where an unscheduled backup may be useful, e.g. when an administrator makes a configuration change

Creating a timer

1. In the Configuration Browser select General Settings > **Timer**.
2. Create a new timer (e.g. **Timer for automatic backup**).
3. Add to this timer under (**Week** or **Extra days**) the times to trigger the creation of a backup.

Note: Trigger times are entered as pairs. As we are using a **state transition** and not a state duration to run the backup (see below) the duration between each pair is unimportant. We can enter, for example **Sunday 11:00-11:01**.

Creating an Association for the automatic backup

1. In the Configuration Browser select General Settings > **Associations**.
2. Create a new Job (e.g. **Backup the Configuration**).

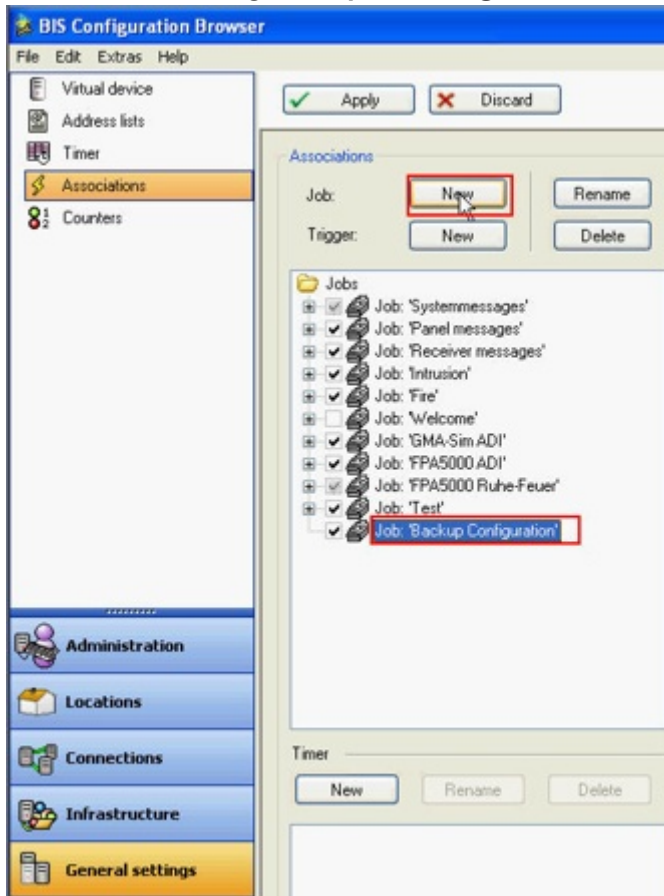

3. Create a new Trigger of type **Address**. Select **Timer** in the Devices pane and in the Groups pane the name of the timer you created above (e.g. **Timer for automatic backup**).

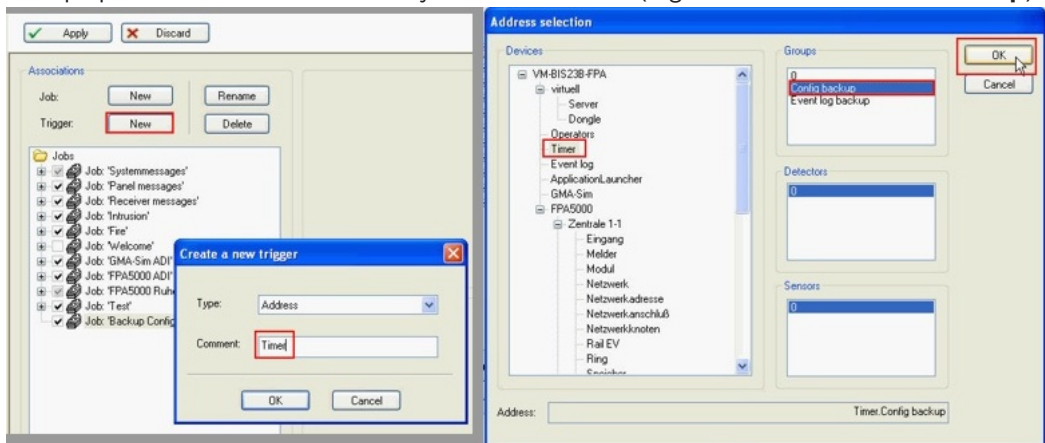

- 4. In the fields labeled **Transition of state** select from the combo-box labeled **“from”** the list entry **266 -Timer off**. Select from the combo-box labeled **“to”** the list entry **265 -Timer on**.

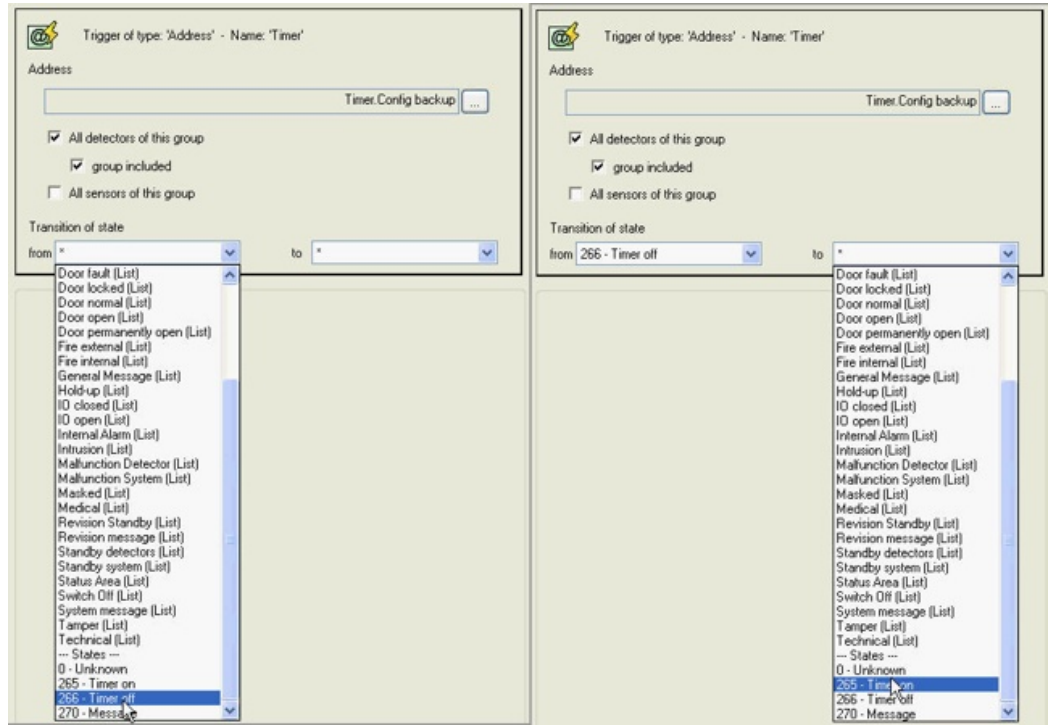

- 5. Select the new trigger in the list of Associations and click the **New** button next to the label **Control**. Create a new control of type **THEN** and object **Address**. Click **OK**. In the ensuing **Create a new control** dialog make sure the check box **Use alarm address** is not selected. In the ensuing **Address selection** dialog select **ApplicationLauncher** from the Devices list, and **Start** under the **Groups** list. Click **OK**.

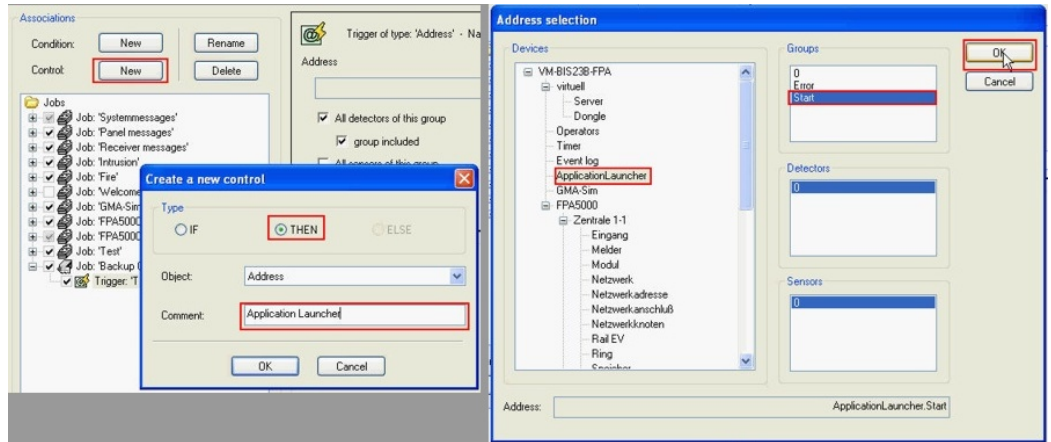

- Back in the Create control dialog select **ApplicationLauncher:Start configuration backup**. In the ensuing Parameter entry dialog set the parameters described in the section **Manual backup** above.

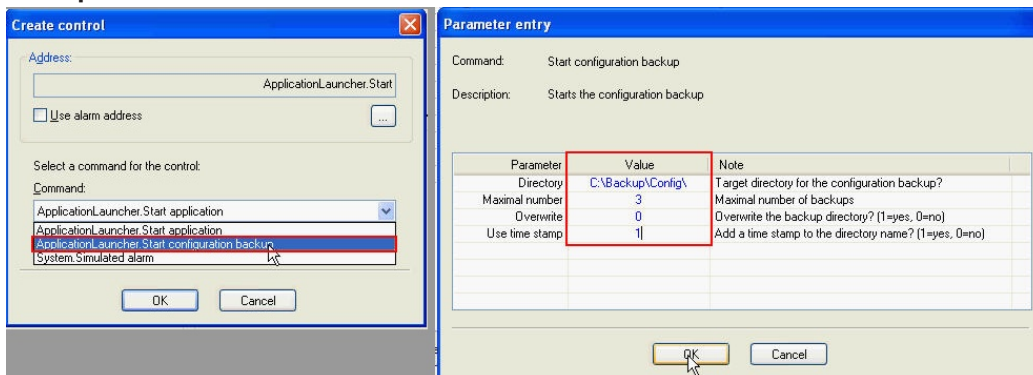

- Illustrating a summary of the settings in this Association.

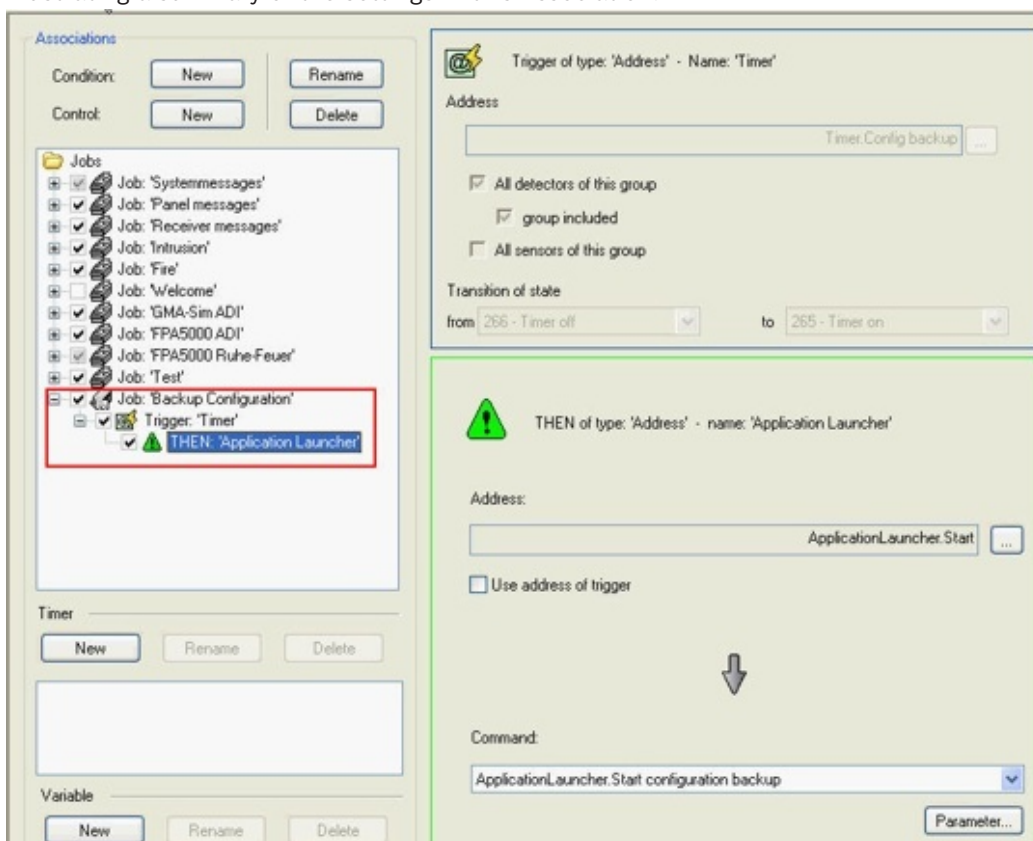

13.23 Device state/condition counters

Counters provide an overview of a device state (for example, you can define a state counter (aka condition counter) for all open windows). You can place this value on the HTML operator interface page. Use FrontPage to integrate the device counter's ActiveX control on the user interface HTML page.

Select the Configuration Browser's **General Settings** Outlook button, then click **Counters**.

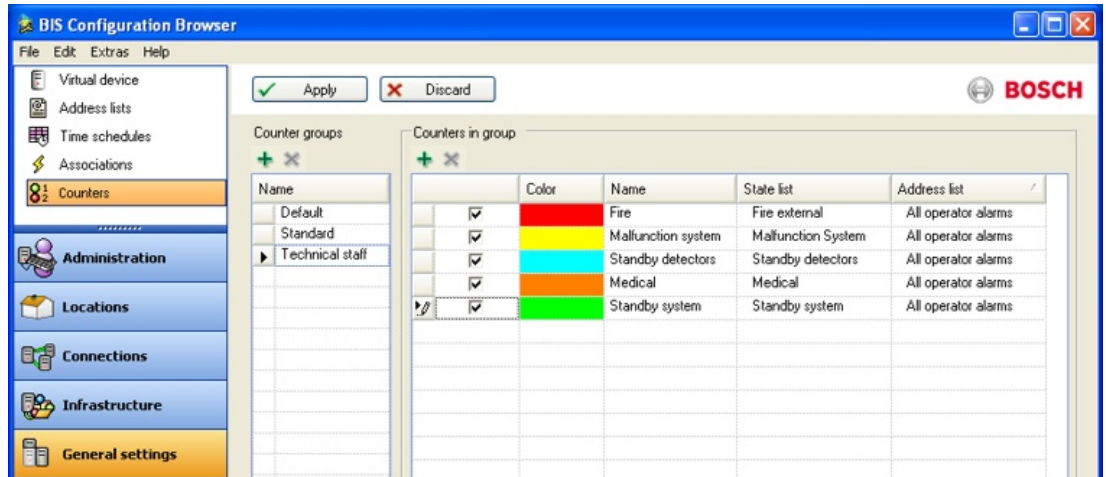

Setting up counters

Set up counters which display the number of standardized line conditions currently in the system in the panel on the right. Depending on the configured interface and counter groups, counters can be permanently displayed.

Click here for more information on: *Creating/Modifying Workstation-Specific Interfaces, page 84*

When setting up a counter, enter the following parameters:3

- The display name - this shows up in the client
- A color (Color dialog)

In order to select or changing the color you open to the colors Dialog with double click in the respective field of the Color column.

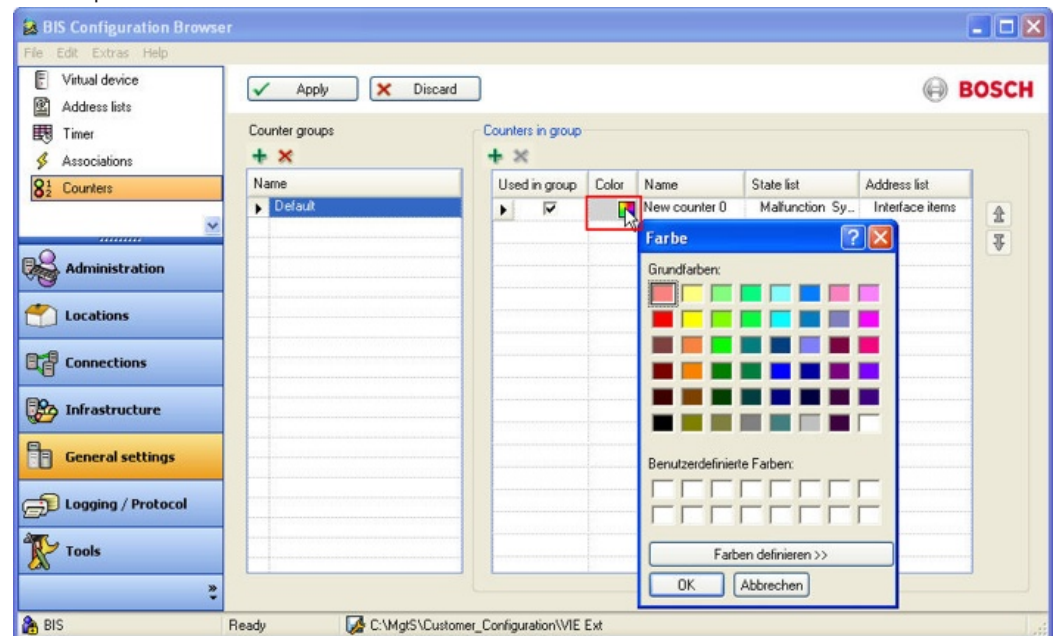

- A State List containing the number of line conditions to monitor (create in the **States** Configuration Browser item)
- An Address List containing the number of detector points to be counted (create using the **Address lists** Configuration Browser item)

A device condition counter can, for example, count only the number of elements contained in the “Panel Items” Address List and having the status “Malfunction Detector”.



Notice!

You cannot create a device condition counter for the status **missing group**.
The following characters are not allowed in Counters or Counter Groups: # < > ' " & * ? .

Counter groups and display of counters

Counters are organized and displayed in **counter groups**. You can add, edit and delete counter groups in the panel on the left. Those groups are used to identify the needed counters in the user interface.

Add a counter group for each required combination of counters. Check in the right panel those counters that are to be visible in the selected group.

To display counters for an operator, add the A1_Counter Control to the HTML page and enter the name of the counter group to display in the ActiveX options. These options let you choose a color for the displayed texts, please check that this color is visible on the HTML-page's background.

13.24

Event log

Select the Configuration Browser's **Logging/Protocol** tab, then click **Event log**.

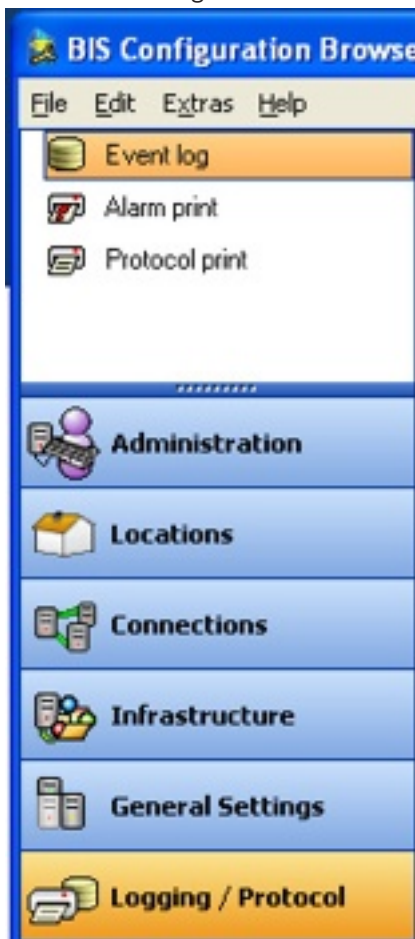

Specifying what is to be recorded

This section describes ways of restricting the types and amount of data recorded in the event log. See *Event log Administrator Settings, page 110* for the database administrative settings, as performed in the BIS Manager.

Distributed Events report

As of BIS version 4.0 it is possible to generate a report that includes events from the event logs of remote BIS servers. For details on configuring the **Distributed Events** report see *Distributed reports configuration, page 201*

Events linked to video archives

Camera events in the event log are linked via their **URL** property to the corresponding position in the video archive.

Similarly, events from other detectors can be linked to video archives by including the camera’s URL in the detector’s properties. Thus, for example, camera images from the time and place of an intruder alarm can be retrieved directly from the Event log.

Limitation: Events from devices in an Access Engine hierarchy cannot be linked in this way. See *Creating connections and addresses by browsing, page 136* for steps to configure this kind of link.

Events that are always recorded in the event log

The following actions are always written to the event log (regardless of the settings below):

- Deletions of messages with action plans
- Configuration changes to DB9000 (Security engine). **Note:** because the security panels are not Division-compliant, DB9000 changes recorded in the Event Log will be visible to all operators.

Customizing what else is recorded in the event log

Choose whether to impose no limitation (option button **all**) or to record only selected data. The number of selected elements is displayed above each list.

The four panes have a cumulative filtering effect. For example, if you specify only the address list “All ACE detectors” (top left pane) and the message states “Card unknown” and “Card not authorized” (bottom right pane), then the event log records nothing but ACE address lists, and therein only those two message types.

Pane	Description
Address lists/ detectors to log	Choose whether to log all or only selected addresses (or address ranges).
State changes to log	Choose whether to log all or only selected line states (or state changes) reported by subsystems.
Commands to log	Choose whether to log all or only selected commands (control operations) as they are carried out.
Message states to log	Choose whether to log all or only selected message states.

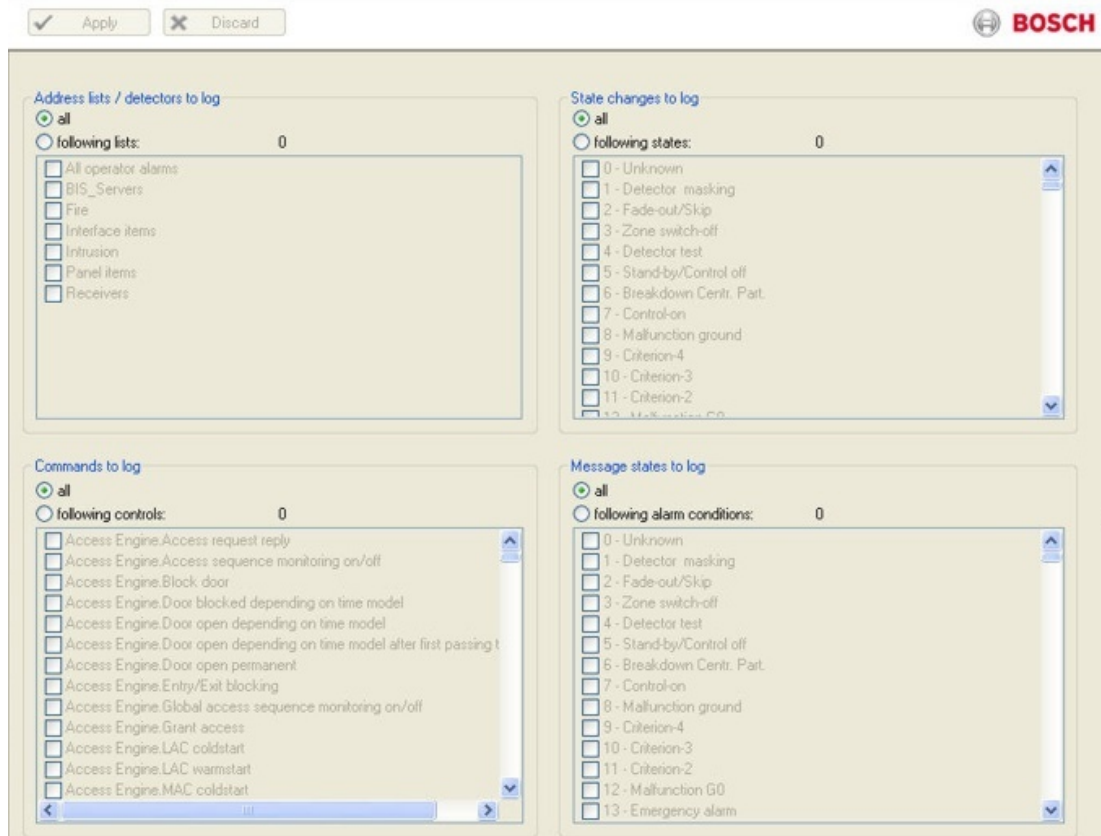

See also

- *Creating connections and addresses by browsing, page 136*

13.25

Alarm print

Select the Configuration Browser's **Logging/Protocol** Outlook button, then click **Alarm print**.

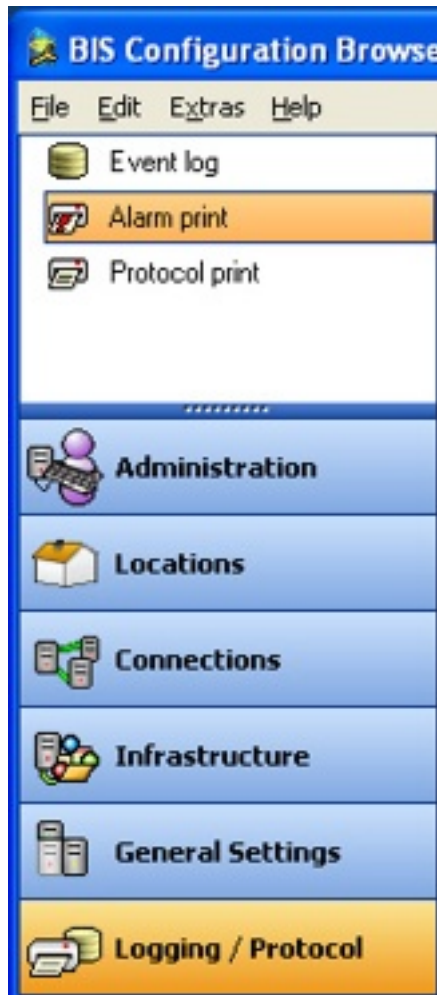

Document printers are graphic-capable printers (not line printers) that print out messages and associated floor plans for operators.

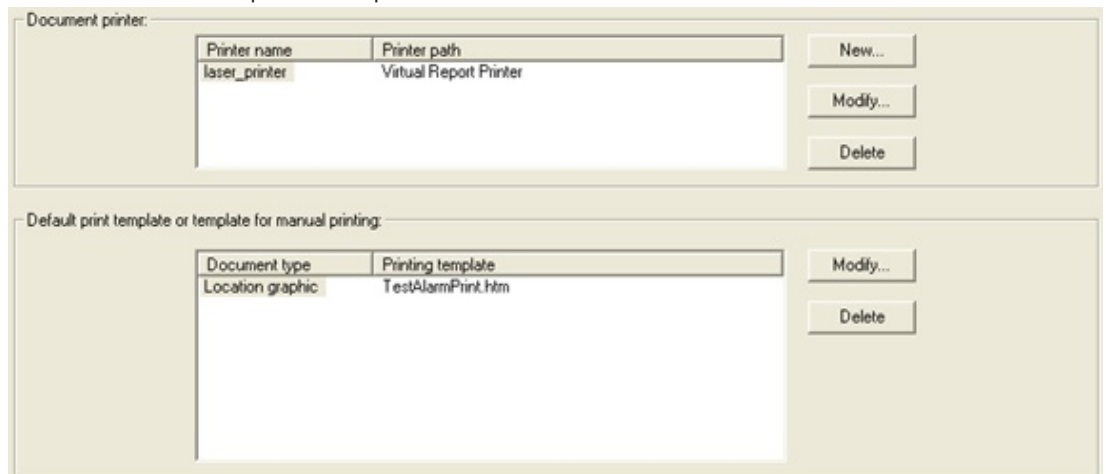

Using the **New** and **Modify** buttons in the top pane, enter the full UNC path (e.g. \\MyServer \MyPrinter) of each printer to be used for alarm printing. **IMPORTANT: make sure that the path(s) that you enter here are known only to those client computers that are really intended for alarm printing.**

For each printer, state which message should cause the printout of its associated floor plan, and whether the printout should occur upon arrival or upon acknowledgement of the message.

In the bottom box, specify the template for manual printing.

Templates are stored in the directory

<INST_DIR>\Customer_Configuration\<MyConfig>\Printouts.

Where <MyConfig> should be replaced by the directory name of the desired configuration.



Notice!

Some HTML editors write a **<!doctype>** statement as first line in any opened HTML document. In this case, BIS displays scroll bars in the Alarm Print - to remove them, delete the doctype line in the HTML document.

13.26

Protocol print

Select the Configuration Browser's **Logging/Protocol** Outlook button, then click **Protocol print**.

To configure the **line printers** that are to print a protocol of system events, proceed as follows:

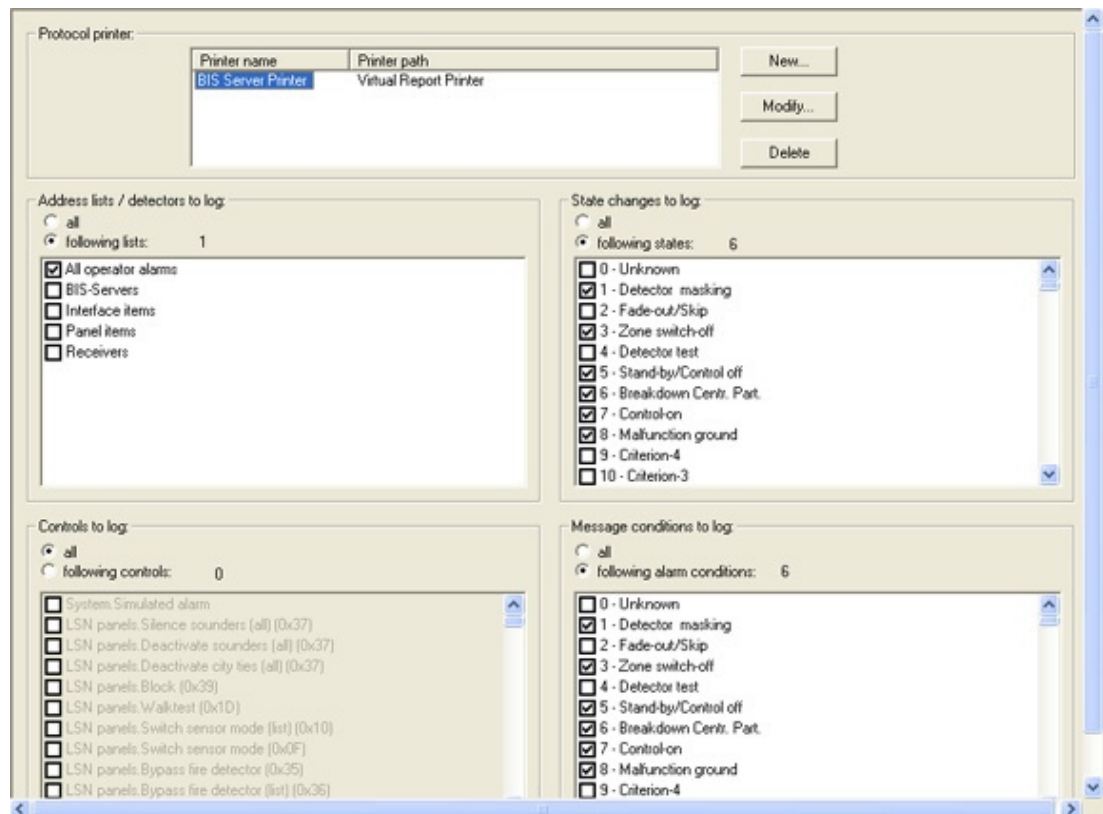

Enter the full UNC path (e.g. \\MyServer\MyPrinter) of the printer(s) to be used in the top box. Then select the events that are to trigger a protocol print. You can choose between the following modes:

- Impose no restrictions - select the radio-button **all**, or
- Assign only certain elements by clicking on the appropriate check boxes. In this case you are shown how many elements you have selected.



Notice!

Protocol printing is designed to work only with line printers, not inkjet or laser printers. Note that printers may print more slowly than messages arrive: In the printer's Advanced properties select the radio button: **Spool print documents so program finishes printing faster** to ensure that the printer can buffer its inputs and will not hold up the entire system in case of a printer fault.

Possible Entries for the events to print

Pane	Description
Address lists/ detectors to log	Choose whether to log all or only selected addresses (or address ranges).
State changes to log	Choose whether to log all or only selected line states (or state changes) reported by subsystems.
Commands to log	Choose whether to log all or only selected commands (control operations) as they are carried out.
Message states to log	Choose whether to log all or only selected message states.



Notice!

If one of the following OPC attributes are set to the value 1, protocol print will occur even if no address lists, state changes, controls or message conditions are defined for protocol print:
 ADI Print – state no. 5008
 Update – state no. 5002

13.27

Tools

In the Configuration Browser, click the Outlook button **Tools**.



13.27.1 Engine-specific tools

Depending on which BIS Engines are installed, the menu will contain different configuration tools.

E.g. for Access Engine:

- ACE Badge designer
- ACE Configuration Import/Export
- ACE System Parameter Editor
- ACE Configuration Card Personalization
- ACE Configuration AMC IP addresses

E.g. for Video Engine:

- VIE Configuration

Select the desired tool and click the start button which appears in the main window pane.

Help on each of these configuration tools is available from the engine-specific modules in this online help.

13.27.2 Remote site configuration

Introduction

This tool is provided as of BIS Version 4.0 for the configuration of Multi-Server BIS systems. In particular the tool is used for creating the encrypted configuration files for Provider servers, that is, servers which make some or all of their addresses visible to Consumer servers.

Concepts and overview

For the main concepts and an overview of BIS multi-server technology, see *BIS multi-server systems*, page 11

Making a BIS server into a Provider server

For the procedure to make a BIS server into a Provider Server, see *Providing information to other BIS single server systems*, page 92

13.27.3 Distributed reports configuration

Introduction

This tool is provided as of BIS Version 4.0 for the configuration of a special event log report that contains events from multiple networked BIS servers .

Specifically the tool creates:

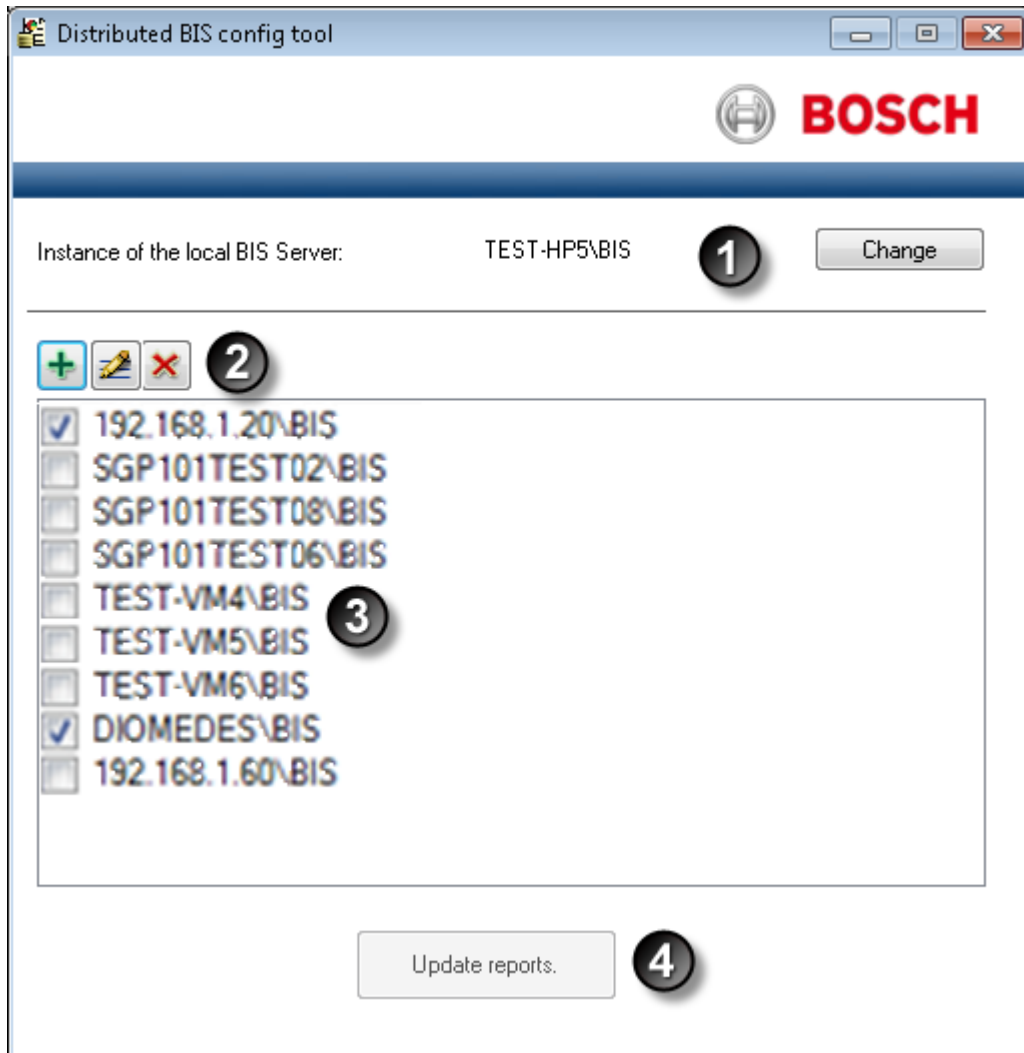

- a local encrypted configuration file that contains information about all the remote BIS servers that may contribute events to the **Distributed Events** report in the local event log.
- a stored procedure, in your local Event log, that accesses the remote event logs.





Label	Description
1	The name of your local server and the current BIS user, separated by a backslash The Change button to modify these if so desired.
2	Buttons for adding, editing and deleting remote BIS servers from the configuration file.
3	The list of remote BIS servers (with the relevant user names) in the configuration file. The selected check boxes mark those remote BIS servers that are not just in the configuration file, but also included in the stored procedure that accesses their event logs.
4	The Update reports button that updates the stored procedure based on the settings you make in this dialog.

Adding or expanding the distributed events report

1. Open the BIS Configuration Browser on the BIS server where the distributed report is to be created.
2. Click Menu: **Tools > Distributed reports configuration**

3. In the main dialog pane, click the button **Start the Configuration**
 - **Effect:** The **Distributed BIS config tool** appears.
 - **Note:** if no configuration file as yet exists, then it will be created at this point. In this case the list of servers:  will be empty.
4. Click the  (**Add**) button to add a remote server to the configuration file
 - **Effect:** A dialog box appears
5. Enter the name of the remote server (or its IP address) and a BIS operator name for that remote server, using backslash as the separator, e.g. **MYSERVER\BisUser1**
 - **Note:** The operator needs to have administrator privileges
6. Either keep the default user credentials, or clear the check box and enter the user name and password of your choice. Click **Apply**
 - **Effect:** The remote server is added to the list in the main dialog.
 - **Effect;** The remote server and username are verified and saved to the configuration file.
 - **Note:** A server's being in the list is necessary but not sufficient to share its event log. It also needs to be included in the stored procedure that accesses remote event logs.
7. Back on the main **Distributed reports configuration** dialog repeat the previous steps to add as many remote BIS servers as desired
8. Select the check boxes next to any servers whose event logs are to be included in the distributed report.
9. Click the **Update reports** button. 
 - **Effect:** Only those remote servers whose check boxes are selected are added to the stored procedure that accesses remote event logs.

Modifying connection data for participating servers

1. Open the BIS Configuration Browser on the BIS server where the distributed report is to be created.
2. Click Menu: **Tools > Distributed reports configuration**
3. In the main dialog pane, click the button **Start the Configuration**
 - **Effect:** The **Distributed BIS config tool** appears.
4. Select the name (not the check box) of the server that you want to edit.
 - **Effect:** The name of the server is highlighted in the list.
5. Click the  (**Edit**) button to edit a remote server in the configuration file
 - **Effect:** A dialog box appears
6. Edit the Instance, user name and/or user credentials in the dialog box. Click **Apply** to save changes.
7. Click the **Update reports** button.  to save the changes to the stored procedure.

Procedures for restricting the distributed report

There are two ways of doing this.

Deactivating remote servers in the configuration file

- To ensure that the events from a remote server are not included in the report, but still keep the remote server in the list for possible future use, clear the relevant check box in the server list on the **Distributed reports configuration** dialog, and click the **Update**

reports button. 

Removing remote servers from the configuration file

1. Alternatively, select the name (not the check box) of the server that you want to delete.
 - **Effect:** The name of the server is highlighted in the list.
2. Click the  (**Delete**) button to remove the remote server from the configuration file and the stored procedure
 - **Effect:** You will be prompted to confirm the deletion. Click **OK** to do so
 - **Effect:** Your modifications to the configuration file and stored procedure are saved.

Glossary

Active Directory

A directory service that authenticates users, computers and other resources in a Windows domain-type network.

BIS server

(Hardware) A computer where the BIS application is installed. Also known as a Login server.

Connection server

(Hardware) A computer that runs OPC server software with which external devices communicate by OPC protocol. The BIS setup program can be used to turn a Windows system into a potential Connection server.

Consumer server

(Hardware) The Consumer server is a BIS single server system that reads information from one or more other BIS single server systems by configuring them as OPC servers.

Database server

(Hardware) A computer that hosts BIS databases for the event log and (optional) engines.

Layer

In the context of location plans a layer is a virtual stratum of information about the infrastructure of a location in an AutoCAD file. See <http://docs.autodesk.com> .

Local Discovery Server

(Software) a Windows Service that is started by BIS and runs in the background to discover OPC UA servers available on the network.

Multi-server BIS system

A multi-server BIS system is one in which two or more BIS single server systems share information. BIS multi-server systems can be organized as hierarchical or peer-to-peer networks.

OPC client

A software program that reads data communications in OPC protocol written by OPC servers.

OPC server

A software program that converts the hardware communication protocol used by a device into the OPC protocol.

OPC UA

OPC Unified Architecture (OPC UA) is an enhanced OPC protocol from the OPC Foundation. It provides better platform independence, scalability and data security than its predecessors.

Plot template

In the context of location plans a plot template is an object from which individual plots inherit certain attributes. See <http://docs.autodesk.com> .

Provider server

(Computer) The Provider server is a BIS single server system that provides information to other BIS single server systems via OPC.

Remote Sites Connector

The Remote Sites Connector (RSC) is an OPC server program running on the Consumer server. It maintains multiple remote sites connections. Multiple Remote Sites Connectors may run simultaneously on a single Consumer server. Separate Remote Sites Connectors are a way of grouping remote sites connections and insulating them from each other.

Single server BIS system

A single server BIS system contains only one BIS Login server (also known as the BIS server). It may run OPC server software itself, and may contain zero or more Connection server and Database server computers.

xref

In the context of location plans an xref is a drawing file referenced by another drawing

Index

A

Action Buttons	80
ActiveX controls	85
Address Lists	167
Alarm print	196
Application Launcher	159
Associations	173
Authentication	77
Authorizations	118
Automatic Backup of Event Log	183

B

Backing up the configuration	187
Automatic (scheduled) backup	189
Manual backup	188
Backup-Restore	112
BIS Manager	103

C

ClientInfo Tool	100
Configuration Printouts	40
Connection server	117
Customizing Buttons	19

D

DB Migration	107
Demo Mode	115
Detector data	51
Detector Placement	141
Detector Type	149
Device Condition Counters	192
Diagnostic Tools	51
Dialog field	14
Divisions	129
Dual authorization	120

E

Error Log	113
Event Log	105, 194
Event Simulation	51
Exporting detector data	51

F

Filling-Organizing Data	52
FrontPage	82

J

JavaScript	87
Job	175

L

Layout	14
License	113

Load-Save Configuration	113
Location Tree	87
Login	32
Logoff	
Immediate operator logoff	36
Postponed operator logoff	36
Deferred operator logoff	36

M

Message Distribution	179
Message Generation	180
Multi-server BIS	
Configuring Consumer servers	95
Configuring Provider servers	92
Creating the configuration file for the Provider server	93
Examining the final list of addresses marked for export to the configuration file	94
Reading and modifying existing configuration files	94

N

NetLimiter Tool	99
New Configuration	35

O

OPC connections	139
OPC server	45
Operators	124

P

Password	32
Protocol Print	198

S

Server Structure	116
Start Configuration	31
Start the BIS Configuration Browser	29
Start-Stop System	26
States	145
Status bar	14
Symbols	20
Symbols blinking	157
System Start-Stop	103

T

Timeouts	179
Timer	170
Title bar	14
Tool bar	14
Transmit Message	105
Tree structure	130

Trigger	175
Typical Associations	182
V	
Version	114
Virtual Device	160
W	
Windows Authentication	77



Bosch Sicherheitssysteme GmbH

Robert-Bosch-Ring 5

85630 Grasbrunn

Germany

www.boschsecurity.com

© Bosch Sicherheitssysteme GmbH, 2018