

BVMS

Table of contents

1	Using the Help	14
1.1	Finding information	14
1.2	Printing the Help	15
2	Introduction	16
2.1	BVMS editions	17
2.2	BVMS License activation overview	18
3	System overview	20
3.1	Hardware requirements	21
3.2	Software requirements	21
3.3	License requirements	21
4	Concepts	22
4.1	BVMS design concepts	22
4.1.1	Single Management Server System	22
4.1.2	Enterprise System	23
4.1.3	Server Lookup	24
4.1.4	Unmanaged site	25
4.2	Recording	27
4.2.1	Automated Network Replenishment (ANR)	27
4.2.2	Dual / failover recording	28
4.2.3	VRM recording modes	29
4.2.4	Playback of VRM recording sources	32
4.2.5	Overview of the storage related events	39
4.3	Alarm handling	40
4.4	ONVIF event mapping	42
4.5	Inactivity logoff	43
4.6	Version independent Operator Client	43
4.6.1	Working with Compatibility Mode	44
4.7	Viewing modes of a panoramic camera	44
4.7.1	360° panoramic camera - floor- or ceiling mounted	44
4.7.2	180° panoramic camera - floor- or ceiling mounted	46
4.7.3	360° panoramic camera - wall mounted	47
4.7.4	180° panoramic camera - wall mounted	48
4.7.5	Cropped view on a panoramic camera	49
4.8	SSH Tunneling	50
4.9	Multipathing	50
5	Supported hardware	51
5.1	Installing hardware	51
5.2	Installing a KBD Universal XF keyboard	52
5.3	Connecting a Bosch IntuiKey keyboard to BVMS	52
5.3.1	Scenarios for Bosch IntuiKey keyboard connections	52
5.3.2	Connecting a Bosch IntuiKey keyboard to a decoder	54
5.3.3	Updating Bosch IntuiKey keyboard firmware	55
5.4	Connecting Bosch Allegiant Matrix to BVMS	56
5.4.1	Bosch Allegiant Connection Overview	56
5.4.2	Configuring the control channel	58
5.4.3	Bosch Allegiant Satellite System Concept	60
5.5	Allegiant CCL commands supported in BVMS	61
6	Use latest software	63

7	Getting started	64
7.1	Installing the software modules	64
7.2	Using Config Wizard	64
7.3	Starting Configuration Client	73
7.4	Configuring the language of Configuration Client	74
7.5	Configuring the language of Operator Client	74
7.6	Scanning for devices	75
7.7	Accessing the system	75
7.8	Using Server Lookup	75
7.9	Activating the software licenses	76
7.9.1	License Manager dialog box (Tools menu)	76
7.9.2	Add license dialog box	78
7.9.3	License Inspector dialog box (Tools menu)	78
7.10	Maintaining BVMS	78
7.11	Replacing a device	79
7.11.1	Replacing a MS / EMS	79
7.11.2	Replacing a VRM	80
7.11.3	Replacing an encoder or decoder	81
7.11.4	Replacing an Operator Client	83
7.11.5	Final tests	84
7.11.6	Recovering Divar IP 3000/7000	84
7.12	Configuring time synchronization	84
7.13	Configuring the storage media of an encoder	84
8	Creating an Enterprise System	86
8.1	Configuring the Server List for Enterprise System	86
8.2	Creating an Enterprise User Group	87
8.3	Creating an Enterprise Account	87
8.4	Token-based authentication	88
9	Configuring Command Scripts	90
9.1	Managing Command Scripts	90
9.2	Configuring a Command Script to be started automatically	91
9.3	Importing a Command Script	91
9.4	Exporting a Command Script	91
9.5	Configuring a startup Command Script (settings page)	92
10	Managing configuration data	93
10.1	Activating the working configuration	93
10.2	Activating a configuration	94
10.3	Exporting configuration data	94
10.4	Importing configuration data	95
10.5	Exporting configuration data to OPC	95
10.6	Checking the status of your encoders/decoders	96
10.7	Configuring SNMP monitoring	96
10.8	Creating a report	96
11	Configuration examples	98
11.1	Adding a Bosch ATM/POS bridge	98
11.2	Adding a Bosch Allegiant input alarm	99
11.3	Adding and configuring 2 Dinion IP cameras with VRM recording	99
12	Global Configuration Client windows	101
12.1	Configuration window	101

12.2	Menu commands	102
12.3	Activation Manager dialog box (System menu)	104
12.4	Activate Configuration dialog box (System menu)	104
12.5	Initial Device Scan dialog box (Hardware menu)	105
12.6	Protect Devices with Global Default Password dialog box (Hardware menu)	105
12.7	Protect iSCSI storages with CHAP password dialog box (Hardware menu)	106
12.8	Change device passwords dialog box (Hardware menu)	106
12.9	Update device firmware dialog box (Hardware menu)	107
12.10	Change device IP and network settings dialog box (Hardware menu)	108
12.11	Device Monitor dialog box (Hardware menu)	110
12.12	Command Script Editor dialog box (Tools menu)	110
12.13	Resource Manager dialog box (Tools menu)	111
12.14	Sequence Builder dialog box (Tools menu)	111
12.15	License Manager dialog box (Tools menu)	111
12.15.1	Add license dialog box	112
12.16	License Inspector dialog box (Tools menu)	112
12.17	Workstation monitoring dialog box (Tools menu)	112
12.18	Reports dialog boxes (Reports menu)	112
12.18.1	Recording Schedules dialog box	113
12.18.2	Scheduled Recording Settings dialog box	113
12.18.3	Task Schedules dialog box	113
12.18.4	Cameras and Recording Parameters dialog box	113
12.18.5	Stream Quality Settings dialog box	113
12.18.6	Event Settings dialog box	113
12.18.7	Compound Event Settings dialog box	113
12.18.8	Alarm Settings dialog box	113
12.18.9	Configured Users dialog box	113
12.18.10	User Groups and Accounts dialog box	114
12.18.11	Device Permissions dialog box	114
12.18.12	Operating Permissions dialog box	114
12.18.13	Configuration Permissions dialog box	114
12.18.14	User Group Permissions dialog box	114
12.18.15	Security Settings dialog box	114
12.18.16	Application permissions dialog box	114
12.18.17	Bypassed devices dialog box	114
12.19	Alarm Settings dialog box (Settings menu)	114
12.20	SNMP Settings dialog box (Settings menu)	114
12.21	LDAP Server Settings dialog box (Settings menu)	115
12.21.1	Associating an LDAP group	117
12.22	Define LDAP user group order dialog box (Settings menu)	117
12.23	Access token settings dialog box (Settings menu)	117
12.24	Trusted certificate settings dialog box (Settings menu)	119
12.25	Options dialog box (Settings menu)	119
13	Devices page	122
13.1	Updating device states and capabilities	122
13.2	Changing the password for IP devices	123
13.3	Adding a device	123
13.4	Server list / Address Book page	126
13.4.1	Add Server dialog box	127

13.4.2	Configuring Server Lookup	127
13.4.3	Configuring the Server List	127
13.4.4	Exporting the Server List	128
13.4.5	Importing a Server List	128
13.5	DVR (Digital Video Recorder) page	128
13.5.1	DVR devices	128
13.5.2	Adding a DVR device via scan	129
13.5.3	Add DVR dialog box	130
13.5.4	Settings tab	130
13.5.5	Cameras tab	130
13.5.6	Inputs tab	130
13.5.7	Relays tab	131
13.5.8	Configuring the integration of a DVR	131
13.6	Matrix Switches page	131
13.6.1	Adding a Bosch Allegiant device	132
13.6.2	Configuring a Bosch Allegiant device	132
13.6.3	Outputs page	132
13.6.4	Inputs page	133
13.6.5	Connection page	133
13.6.6	Cameras page	134
13.7	Workstation page	134
13.7.1	Adding a workstation manually	134
13.7.2	Configuring a Bosch IntuiKey keyboard (settings page) (workstation)	135
13.7.3	Enabling Forensic Search on a workstation (settings page)	135
13.7.4	Configuring a startup Command Script (settings page)	135
13.7.5	Settings page	136
13.7.6	Changing the network address of a workstation	137
13.8	Decoders page	137
13.8.1	Adding an Encoder / Decoder manually	138
13.8.2	Edit Encoder / Edit Decoder dialog box	139
13.8.3	Changing the password of an encoder / decoder (Change password / Enter password)	140
13.8.4	Decoder profile	141
13.8.5	Monitor display	142
13.8.6	Configuring a Bosch IntuiKey keyboard (decoder)	142
13.8.7	Configuring a decoder for use with a Bosch IntuiKey keyboard	142
13.8.8	Delete decoder logo	143
13.9	Monitor groups page	143
13.9.1	Adding a monitor group manually	143
13.9.2	Configuring a monitor group	144
13.10	Communication Devices page	144
13.10.1	Adding an E-mail/SMTP Server	144
13.10.2	SMTP Server page	145
13.10.3	Configuring a communication device	145
13.10.4	Send Test E-mail dialog box	146
13.11	ATM/POS page	146
13.11.1	Adding a Bosch ATM/POS-Bridge manually	146
13.11.2	Bosch ATM/POS-Bridge page	147
13.11.3	Configuring a peripheral device	147
13.11.4	DTP Settings page	148

13.11.5	ATM Settings page	148
13.11.6	Inputs page	149
13.12	Foyer Card Readers	149
13.12.1	Add Foyer Card Reader dialog box	149
13.12.2	Settings for Foyer Card Reader page	149
13.13	Virtual Inputs page	150
13.13.1	Adding Virtual Inputs manually	150
13.14	SNMP page	151
13.14.1	Adding an SNMP manually	151
13.14.2	Configuring an SNMP trap receiver (SNMP trap receiver page)	151
13.14.3	SNMP Trap Logger dialog box	152
13.15	Assign Keyboard page	152
13.16	I/O Modules page	154
13.16.1	Adding an I/O module manually	154
13.16.2	Configuring an I/O module	154
13.16.3	ADAM page	155
13.16.4	Inputs page	155
13.16.5	Relays page	155
13.17	Allegiant CCL Emulation page	155
13.17.1	Adding an Allegiant CCL emulation manually	156
13.17.2	Allegiant CCL commands	156
13.17.3	Configuring an Allegiant CCL emulation	156
13.18	Mobile Video Service page	157
13.18.1	Mobile Video Service	157
13.18.2	Adding a Mobile Video Service manually	157
13.19	Intrusion panels page	158
13.19.1	Adding an Intrusion Panel manually	158
13.19.2	Settings page	159
13.20	Access control systems page	159
13.20.1	Adding an access control system	159
13.20.2	Editing an access control system	160
13.20.3	Settings page	160
13.21	Video analytics page	160
13.21.1	Video Analytics Settings page	160
13.21.2	Adding a Video Analytics Device	161
13.21.3	Person Identification devices page	161
13.21.4	Adding a Person Identification device (PID)	161
13.21.5	PID page	162
13.21.6	Restoring access to a PID after a BVMS central server breakdown	163
13.21.7	Adding cameras to a Person Identification device (PID)	163
13.21.8	Configuring camera parameters for Person Identification alarms	164
13.21.9	Configuring person groups	164
13.21.10	Adding a LPR device	165
13.22	VRM Devices page	166
13.22.1	Adding VRM Devices via scan	166
13.22.2	Adding a primary or secondary VRM manually	168
13.22.3	Editing a VRM device	169
13.22.4	VRM Settings page	169
13.22.5	SNMP page	170

13.22.6	Accounts page	170
13.22.7	Advanced page	170
13.22.8	Encrypting recording for VRM	171
13.22.9	Changing the password of a VRM device	172
13.22.10	Adding a VRM pool	172
13.22.11	Adding a Failover VRM manually	172
13.22.12	Adding a Mirrored VRM manually	173
13.22.13	Adding Encoders via scan	174
13.22.14	Adding VSG devices via scan	175
13.22.15	Synchronizing BVMS configuration	175
13.22.16	Importing configuration from VRM	175
13.23	Pool page	176
13.23.1	Configuring automatic recording mode on a pool	177
13.23.2	Adding an Encoder / Decoder manually	177
13.23.3	Adding an iSCSI device manually	178
13.23.4	Adding a Video Streaming Gateway manually	179
13.23.5	Adding a DSA E-Series iSCSI device manually	181
13.23.6	Adding Encoders via scan	183
13.23.7	Adding VSG devices via scan	183
13.23.8	Configuring dual recording in the Device Tree	183
13.24	Bosch Encoder / Decoder page	184
13.25	iSCSI device page	184
13.25.1	iSCSI storage pool	184
13.25.2	Adding an iSCSI device manually	185
13.25.3	Adding a DSA E-Series iSCSI device manually	186
13.25.4	Configuring an iSCSI device	188
13.25.5	Basic Configuration page	189
13.25.6	Load Balancing dialog box	190
13.25.7	Moving an iSCSI system to another pool (Change pool...)	191
13.25.8	LUNs page	191
13.25.9	Adding a LUN	192
13.25.10	Formatting a LUN	193
13.25.11	iqn-Mapper dialog box	193
13.26	Video Streaming Gateway device page	193
13.26.1	Adding a Video Streaming Gateway manually	194
13.26.2	Editing a Video Streaming Gateway	195
13.26.3	Adding a camera to a VSG	196
13.26.4	Add Bosch Encoder dialog box	196
13.26.5	Add ONVIF Encoder dialog box	197
13.26.6	Add JPEG Camera dialog box	199
13.26.7	Add RTSP Encoder dialog box	200
13.26.8	Moving a VSG to another pool (Change pool)	200
13.26.9	Configuring multicast (multicast tab)	201
13.26.10	Configuring logging (advanced tab)	201
13.26.11	Starting ONVIF Camera Event Driver Tool from Configuration Client	202
13.27	Live Only page	203
13.27.1	Adding live only devices via scan	203
13.27.2	Adding an Encoder / Decoder manually	203
13.27.3	Providing the destination password for a decoder (Authenticate...)	204

13.28	Local Storage page	205
13.29	Unmanaged Site page	205
13.29.1	Adding an unmanaged site manually	206
13.29.2	Importing unmanaged sites	206
13.29.3	Unmanaged Site page	206
13.29.4	Adding an unmanaged network device	206
13.29.5	Configuring the time zone	207
14	Bosch Encoder / Decoder / Camera page	209
14.1	Adding an encoder to a VRM pool	210
14.2	Adding a live only encoder	211
14.3	Adding a local storage encoder	211
14.4	Adding a single placeholder camera	211
14.5	Editing an Encoder	211
14.5.1	Encrypting live video (Edit Encoder)	211
14.5.2	Updating the device capabilities (Edit Encoder)	212
14.5.3	Edit Encoder / Edit Decoder dialog box	213
14.6	Managing the verification of authenticity	214
14.6.1	Verification of authenticity	214
14.6.2	Configuring the authentication	215
14.6.3	Uploading a certificate	216
14.6.4	Downloading a certificate	216
14.6.5	Installing a certificate on a workstation	216
14.7	Providing the destination password for a decoder (Authenticate...)	217
14.8	Changing the password of an encoder / decoder (Change password / Enter password)	217
14.9	Moving an encoder to another pool (Change Pool)	218
14.10	Recovering recordings from a replaced encoder (Associate with recordings of predecessor)	218
14.11	Configuring encoders / decoders	219
14.11.1	Configuring the storage media of an encoder	219
14.11.2	Configuring multiple encoders / decoders	220
14.11.3	Configuring failover recording mode on an encoder	222
14.11.4	Recording Management page	222
14.11.5	Recording preferences page	223
14.12	Configuring multicast	223
15	ONVIF page	225
15.1	Adding an live only ONVIF device via scan	225
15.2	ONVIF Encoder page	225
15.3	ONVIF Encoder Events page	226
15.3.1	Adding and removing an ONVIF profile	228
15.3.2	Exporting an ONVIF mapping table file	228
15.3.3	Importing an ONVIF mapping table file	229
15.3.4	Configuring an ONVIF mapping table	230
15.4	ONVIF Configuration page	231
15.4.1	Unit Access	232
15.4.2	Date / Time	232
15.4.3	User Management	233
15.4.4	Video Encoder Profile page	234
15.4.5	Audio Encoder Profile	236
15.4.6	Imaging General	236
15.4.7	Backlight Compensation	237

15.4.8	Exposure	237
15.4.9	Focus	238
15.4.10	Wide Dynamic Range	239
15.4.11	White balance	239
15.4.12	Network Access	240
15.4.13	Scopes	242
15.4.14	Relays	243
15.5	ONVIF Event Source page	243
15.6	Assigning an ONVIF profile	244
16	Maps and Structure page	246
17	Configuring maps and the logical tree	248
17.1	Configuring the Logical Tree	248
17.2	Adding a device to the Logical Tree	249
17.3	Removing a tree item	249
17.4	Managing resource files	249
17.4.1	Resource Manager dialog box	251
17.4.2	Select Resource dialog box	251
17.5	Adding a document	252
17.5.1	Add URL dialog box	252
17.6	Link to External Application dialog box	253
17.7	Adding a Command Script	253
17.8	Adding a camera sequence	253
17.8.1	Sequence Builder dialog box	254
17.9	Managing pre-configured camera sequences	254
17.9.1	Add Sequence dialog box	256
17.9.2	Add Sequence Step dialog box	256
17.10	Adding a folder	256
17.11	Adding a map	256
17.12	Adding a link to another map	257
17.12.1	Select Map for Link dialog box	257
17.13	Assigning a map to a folder	257
17.14	Managing devices on a site map	258
17.15	Configuring the global map and map viewports	258
17.15.1	Configuring the global map	259
17.15.2	Configuring cameras on the global map	260
17.15.3	Adding maps on the global map	261
17.16	Adding a map viewport	262
17.17	Enabling the Map-based tracking assistant	263
17.18	Adding a malfunction relay	263
17.18.1	Malfunction Relay dialog box	264
17.19	Configuring bypass of devices	264
18	Schedules page	265
18.1	Recording Schedules page	265
18.2	Task Schedules page	265
19	Configuring schedules	267
19.1	Configuring a Recording Schedule	267
19.2	Adding a Task Schedule	268
19.3	Configuring a standard Task Schedule	268
19.4	Configuring a recurring Task Schedule	268

19.5	Removing a Task Schedule	269
19.6	Adding holidays and exception days	269
19.7	Removing holidays and exception days	270
19.8	Renaming a schedule	270
20	Cameras and Recording page	271
20.1	Cameras page	271
20.2	Recording settings pages	274
21	Configuring cameras and recording settings	276
21.1	Copying and pasting in tables	276
21.2	Exporting the Camera Table	277
21.3	Configuring stream quality settings	277
21.3.1	Stream Quality Settings dialog box	278
21.4	Configuring camera properties	281
21.5	Configuring recording settings (only VRM and Local Storage)	281
21.6	Scheduled Recording Settings dialog box (only VRM and Local Storage)	282
21.7	Configuring PTZ port settings	284
21.8	Configuring predefined positions and auxiliary commands	284
21.9	Predefined positions and AUX commands dialog box	285
21.10	Configuring the ROI function	286
21.11	Configuring the ANR function	287
21.12	Configuring dual recording in the Camera Table	287
21.13	Managing Video Streaming Gateway	287
21.13.1	Assigning an ONVIF profile	287
22	Events page	289
22.1	Debounce Settings tab	290
22.2	Settings tab for advanced map display	290
22.3	Settings tab for event configuration	291
22.4	Command Script Editor dialog box	291
22.5	Create Compound Event / Edit Compound Event dialog box	292
22.6	Select Script Language dialog box	292
22.7	Edit Priorities of Event Type dialog box	292
22.8	Select Devices dialog box	293
22.9	Text Data Recording dialog box	293
23	Alarms page	294
23.1	Alarm Settings dialog box	295
23.2	Select Image Pane Content dialog box	295
23.3	Select Image Pane Content dialog box (MG)	296
23.4	Alarm Options dialog box	297
23.5	Select Resource dialog box	301
24	Configuring events and alarms	302
24.1	Copying and pasting in tables	303
24.2	Removing a table row	303
24.3	Managing resource files	303
24.4	Configuring an event	303
24.5	Duplicating an event	303
24.6	Logging user events	304
24.7	Configuring user event buttons	304
24.8	Creating a Compound Event	305
24.9	Editing a Compound Event	306

24.10	Configuring an alarm	306
24.11	Configuring settings for all alarms	306
24.12	Configuring the pre- and post-alarm duration for an alarm	307
24.13	Triggering alarm recording with text data	307
24.14	Adding text data to continuous recording	308
24.15	Protecting alarm recording	308
24.16	Configuring blinking hotspots	309
24.17	Events and alarms for access control systems	310
24.18	Events and alarms for Person Identification	310
25	User Groups page	311
25.1	User Group Properties page	313
25.2	User Properties page	313
25.3	Logon Pair Properties page	314
25.4	Camera Permissions page	315
25.5	Control Priorities page	316
25.6	Copy User Group Permissions dialog box	316
25.7	Decoder Permissions page	317
25.8	Events and Alarms page	317
25.9	Credentials page	318
25.10	Logical Tree page	318
25.11	Operator Features page	319
25.12	Priorities page	322
25.13	User Interface page	322
25.14	Server Access page	323
25.15	Configuration Permissions page	324
25.16	User Group Permissions page	325
25.17	Account policies page	326
25.17.1	Offline Operator Client	327
25.18	Permissions for logon per application type page	330
25.19	Threat management settings page	331
26	Configuring users, permissions and Enterprise Access	332
26.1	Creating a group or account	333
26.1.1	Creating a standard user group	333
26.1.2	Creating an Enterprise User Group	333
26.1.3	Creating an Enterprise Account	334
26.2	Creating a user	335
26.3	Creating a dual authorization group	335
26.4	Adding a logon pair to dual authorization group	336
26.5	Configuring Admin Group	337
26.6	Selecting an associated LDAP group	337
26.7	Scheduling user logon permission	338
26.8	Configuring operating permissions	338
26.9	Configuring device permissions	338
26.10	Configuring various priorities	339
26.11	Copying user group permissions	339
27	Configuring video-based fire alarm detection	341
27.1	Configuring a fire detection camera	341
27.2	Adding an encoder to a VRM pool	342
27.3	Adding Encoders via scan	342

27.4	Adding live only devices via scan	342
27.5	Adding local storage encoders via scan	343
27.6	Configuring a fire event	343
27.7	Configuring a fire alarm	343
28	Configuring MIC IP 7000 connected to a VIDEOJET 7000 connect	345
29	Troubleshooting	346
29.1	Configuring the desired language in Windows	347
29.2	Reestablishing the connection to a Bosch IntuiKey keyboard	348
29.3	Reducing the number of Allegiant cameras	348
29.4	Used ports	348
29.5	Enabling logging for ONVIF events	354
	Glossary	356
	Index	365

1 Using the Help



Notice!

This document describes some functions that are not available for BVMS Viewer. For detailed information about the different BVMS editions refer to www.boschsecurity.com and the BVMS Quick Selection Guide: [BVMS Quick Selection Guide](#).

To find out more about how to do something in BVMS, access the online Help using any of the following methods.

To use the Contents, Index, or Search:

- ▶ On the **Help** menu, click **Display Help**. Use the buttons and links to navigate.

To get help on a window or dialog:

- ▶ On the toolbar, click  .

OR

- ▶ Press F1 for help on any program window or dialog.

1.1 Finding information

You can find information in the Help in several ways.

To find information in the Online Help:

1. On the **Help** menu, click **Help**.
2. If the left-hand pane is not visible, click the **Show** button.
3. In the Help window, do the following:

Click:	To:
Contents	Display the table of contents for the Online Help. Click each book to display pages that link to topics, and click each page to display the corresponding topic in the right-hand pane.
Index	Search for specific words or phrases or select from a list of index keywords. Double-click the keyword to display the corresponding topic in the right-hand pane.
Search	Locate words or phrases within the content of your topics. Type the word or phrase in the text field, press ENTER, and select the topic you want from the list of topics.

Texts of the user interface are marked **bold**.

- ▶ The arrow invites you to click on the underlined text or to click an item in the application.

Related Topics

- ▶ Click to display a topic with information on the application window you currently use. This topic provides information on the application window controls.

Concepts, page 22 provides background information on selected issues.



Notice!

This symbol indicates a potential risk of property damage or data loss.

1.2 Printing the Help

While using the Online Help, you can print topics and information right from the browser window.

To print a Help topic:

1. Right-click in the right pane and select **Print**.
The **Print** dialog box opens.
2. Click **Print**.
⇒ The topic is printed to the specified printer.

2 Introduction

Click the link to access the Open Source Software licenses used by BVMS and the Mobile App:
<http://www.boschsecurity.com/oss/>



Covered by one or more claims of the patents listed at patentlist.hevcadvance.com.

This manual guides you through the basic steps of the configuration with BVMS.

For detailed help and step-by-step instructions read the Configuration Manual or use the Online Help.

BVMS

BVMS integrates digital video, audio and data across any IP network.

The system consists of the following software modules:

- Management Server
- VRM recording (Video Recording Manager)
- Operator Client
- Configuration Client

To achieve a running system, you must perform the following tasks:

- Install services (Management Server and VRM)
- Install Operator Client and Configuration Client
- Connect to network
- Connect devices to network
- Basic configuration:
 - Add devices (e.g. by device scan)
 - Build logical structure
 - Configure schedules, cameras, events, and alarms
 - Configure user groups

BVMS Export Player

BVMS Export Player displays exported recordings.

BVMS Viewer

The BVMS Viewer is an IP video security application for live viewing and playback video of Bosch network attached cameras and recorders. The software package consists of an Operator Client for live viewing and playback of video and a Configuration Client. The BVMS Viewer supports the current Bosch IP video product portfolio as well as legacy Bosch video devices.

Click the link to access the Open Source Software licenses used by BVMS Viewer:
<http://www.boschsecurity.com/oss>.

BVMS Configuration Client

The idea of the BVMS Configuration Client is to start with the configuration of the devices, followed by the configuration of the logical tree. After these two steps, the schedules, recordings, events, and alarms for the devices can be configured on their respective pages. The last step is to configure the user groups in the user groups page. After configuring all pages from left to right, everything is configured and the operator can start using the Operator Client.

After configuring each page, save the configuration by clicking  in the tools menu.

To make the changes visible in the BVMS Operator Client , click  .

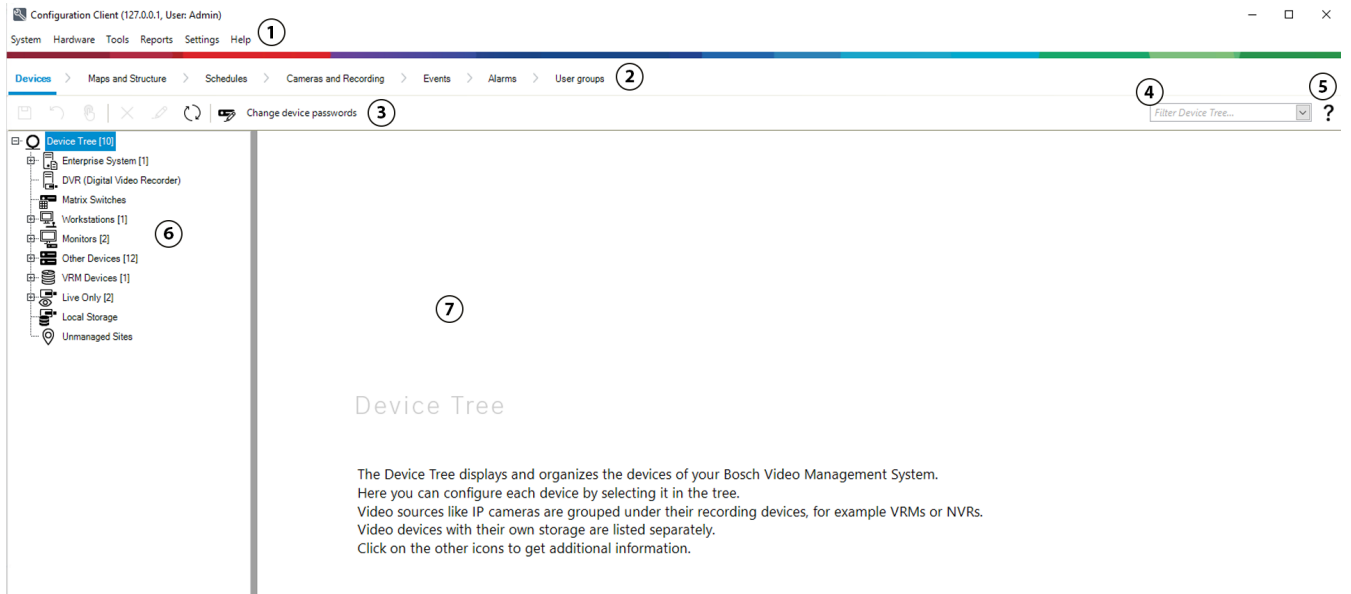

1	Menu bar	Allows you to select a menu command.
2	Pages bar	Allows you to configure all necessary steps from left to right.
3	Tool bar	Displays the available buttons according to the active tab. Hover over an icon to display the tooltip.
4	Search bar	Allows you to search for a specific device and their corresponding parents in the device tree.
5	Help icon	Displays the online help for the BVMS Configuration Client.
6	Selection window	Hierarchical list of all available devices in the system.
7	Configuration window	Allows you to configure the selected device.

BVMS Operator Client

2.1 BVMS editions

The different BVMS editions offer you full scalability, so you can expand your video surveillance system according to your needs.

The following editions of BVMS are available:

- BVMS Professional
- BVMS Enterprise
- BVMS Plus
- BVMS Lite
- BVMS Viewer

BVMS Viewer and BVMS Professional are Software Only products. You can not use them on Bosch DIVAR IP devices.

You can use BVMS Lite and BVMS Plus on Bosch DIVAR IP devices or as Software Only products on any other hardware.

For detailed information about the different BVMS editions refer to www.boschsecurity.com and the BVMS Quick Selection Guide:

[BVMS Quick Selection Guide](#).

2.2 BVMS License activation overview

This chapter provides an overview about the license activation of BVMS.

License ordering

- Order by using the Bosch order desk.
- The order confirmation includes the new software order ID that is required for the later software activation process.
- From BVMS 11.0 the BVMS base and expansion licenses are no longer software version dependent.

License activation

- The Bosch Remote Portal (<https://www.remote.boschsecurity.com>) replaces the Bosch **License Manager**.
- A new user registration is required in Bosch Remote Portal.
- Mandatory input for the license activation is the System info file and the Software order ID.
- The output of the Remote Portal is the License file and includes all activation details. Add this file to the installed BVMS system.
- The activation process defines the start date of the software assurance period. The end date is displayed on the **License Manager** of the BVMS Configuration Client.

Software license activation process

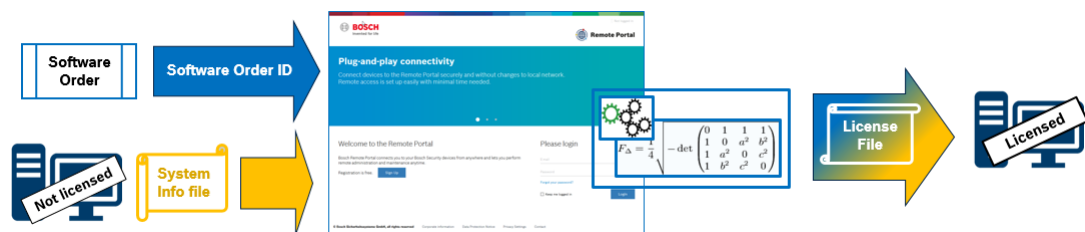

To activate your software licenses do the following:

1. Order software products
 - Order your software products by following the standard Bosch ordering process.
 - Software orders can consist of one or multiple products of one or multiple product editions.
2. Receive the software order ID
 - The result of the order is a software order confirmation that contains the software order ID.
 - The software order ID allows connect the installed software (on operating system and hardware) to the ordered software products.
3. Activate the license
 - Mandatory input for license activation is the system info file that represents the unique operating system and hardware where the software is installed.

-
- The activation connects the software order ID to the installed software and creates the license file as an output.
 - The activation defines attributes of the system, like the software assurance start and end date.
4. Activate the software
- In order to activate the software, add the license file to the installed software.
 - The license files enables the BVMS features according to the activated items.
-

**Notice!****The license file includes the following activation details:**

- BVMS product edition
 - BVMS version allowed
 - Software Assurance expiring date
 - Number of expansion/feature license
-

Refer to

- *Activating the software licenses, page 76*

3 System overview



Notice!

This document describes some functions that are not available for BVMS Viewer.

For detailed information about the different BVMS editions refer to www.boschsecurity.com and the BVMS Quick Selection Guide: [BVMS Quick Selection Guide](#).

If you plan to install and configure BVMS, participate in a system training on BVMS. Refer to the Release Notes of the current BVMS version for supported versions of firmware and hardware and other important information.

See data sheets on Bosch workstations and servers for information on computers where BVMS can be installed.

The BVMS software modules can optionally be installed on one PC.

Important components

Component	Description
Management Server (selectable in Setup)	Stream management, alarm management, priority management, Management logbook, user management, device state management. Additional Enterprise System license: Managing Enterprise User Groups and Enterprise Accounts.
Config Wizard	Easy and fast setup of a recording system.
Configuration Client (selectable in Setup)	System configuration and administration for Operator Client.
Operator Client (selectable in Setup)	Live monitoring, storage retrieval and playback, alarm and accessing multiple Management Server computers simultaneously.
Video Recording Manager (selectable in Setup)	Distributing storage capacities on iSCSI devices to the encoders, while handling load balancing between multiple iSCSI devices. Streaming playback video and audio data from iSCSI to Operator Clients.
Mobile Video Service (selectable in Setup)	Provides a transcoding service that transcodes the live and recorded video stream from a camera configured in BVMS to the available network bandwidth. This service enables video clients like an iPhone or a Web client to receive transcoded streams, for example for unreliable network connections with limited bandwidth.
Web Client	You can access live and playback videos via Web browser.
Mobile App	You can use the Mobile App on iPhone or iPad to access live and playback video.
Bosch Video Streaming Gateway (selectable in Setup)	Provides the integration of 3rd party cameras, e.g. in low-bandwidth networks.
Cameo SDK (selectable in Setup)	The Cameo SDK is used to embed BVMS live and playback Image panes to your external third-party application. The Image panes follow the BVMS based user permissions.

Component	Description
	The Cameo SDK provides a subset of the BVMS Operator Client functionalities that enables you to create applications similar to the Operator Client.
Client Enterprise SDK	The Client Enterprise SDK is meant to control and monitor the behaviour of Operator Client of an Enterprise System by external applications. The SDK allows to browse devices that are accessible by the running, connected Operator Client and to control some UI functionalities.
Client SDK / Server SDK	The Server SDK is used to control and monitor the Management Server by scripts and external applications. You can use those interfaces with a valid administrator account. The Client SDK is used to control and monitor the Operator Client by external applications and scripts (part of the related server configuration).

3.1 Hardware requirements

See the data sheet for BVMS. Data sheets for platform PCs are also available.

3.2 Software requirements

You can not install the BVMS Viewer where any other BVMS component is installed.
See the data sheet for BVMS.

3.3 License requirements

See the data sheet for BVMS for the available licenses.

4 Concepts

**Notice!**

BVMS Viewer offers only basic features. Advanced features are included in BVMS Professional. For detailed information about the different BVMS editions refer to www.boschsecurity.com and the BVMS Quick Selection Guide: [BVMS Quick Selection Guide](#).

This chapter provides background information on selected issues.

4.1 BVMS design concepts

Single Management Server System, page 22

A single BVMS Management Server System provides management, monitoring and control of up to 2000 cameras/encoders.

Enterprise System, page 23

An Enterprise Management Server provides simultaneous access to multiple Management Servers. The Enterprise System allows full access to events and alarms from multiple subsystems.

Server Lookup, page 24

The Server Lookup feature provides a list of available BVMS Management Servers to the BVMS Operator Client. The Operator can select a server out of the list of available server. Connected to the Management Server the Client has full access to the Management Server.

Unmanaged site, page 25

Devices can be grouped to unmanaged sites. Devices under unmanaged sites are not monitored by the Management Server. The Management Server provides a list of unmanaged sites to the Operator Client. The Operator can connect on demand to the site and gets access to live video data and recorded video data. Event and alarm handling is not available in the unmanaged site concept.

4.1.1 Single Management Server System

- A single BVMS Management Server can manage up to 2000 channels.
- A BVMS Management Server provides management, monitoring, and control of the entire system.
- The BVMS Operator Client is connected to the Management Server and receives events and alarms from the BVMS Management Server and shows live and playback.
- In most cases all devices are in one local area network with a high bandwidth and a low latency.

Responsibilities:

- Configuring data
- Event log (logbook)
- User profiles
- User priorities
- Licensing
- Event- and alarm-management



	Live, playback, events, alarms
	Management Server
	Operator Client / Configuration Client
	Cameras
	VRM
	iSCSI
	Other devices

4.1.2 Enterprise System

- The target of a BVMS Enterprise System is to enable a user of an Operator Client to simultaneously access multiple Management Servers (subsystems).
- Clients connected to an Enterprise Server have full access to all cameras and recordings from the subsystems.
- Clients connected to an Enterprise Server have full real time awareness of events and alarms of all subsystems.
- Typical application areas:
 - Metros
 - Airports

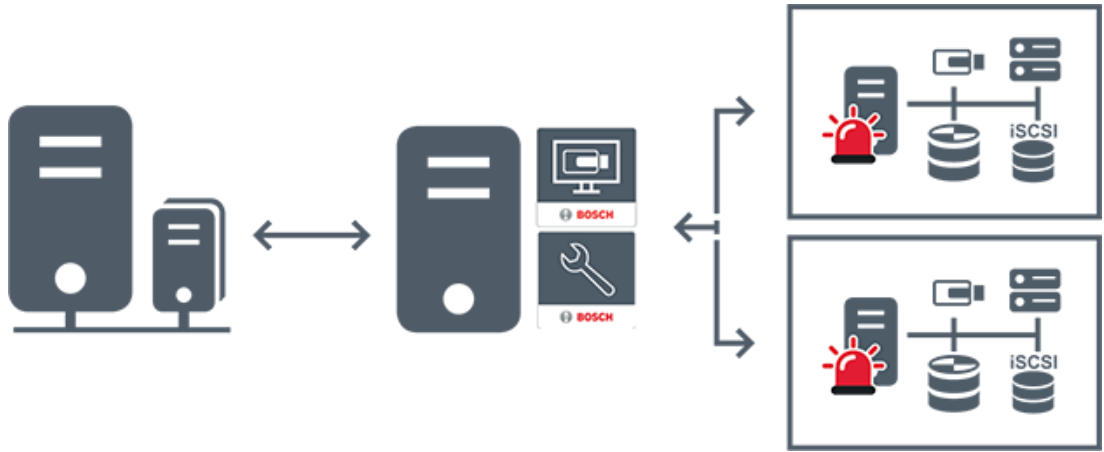

	Live, playback, events, alarms
	BVMS Enterprise Management Server
	BVMS Operator Client / Configuration Client
	BVMS Subsystem

Refer to

- *Creating an Enterprise System, page 86*
- *Configuring the Server List for Enterprise System, page 86*
- *Configuring users, permissions and Enterprise Access, page 332*
- *Accessing the system, page 75*

4.1.3

Server Lookup

- The BVMS Server Lookup feature allows Operators to connect to a BVMS Management Server out of a provided list of servers.
- A single user of Configuration Client or Operator Client can connect to multiple system access points sequentially.
- System access points can be Management Server or Enterprise Management Server.
- Server Lookup uses dedicated Management Server to host the Server List.
- Server Lookup and Management Server or Enterprise Management Server functionally can be run on one machine.
- Server Lookup supports you in locating system access points by their names or descriptions.
- Once connected to the Management Server the Operator Client receives events and alarms from the BVMS Management Server and shows live and playback

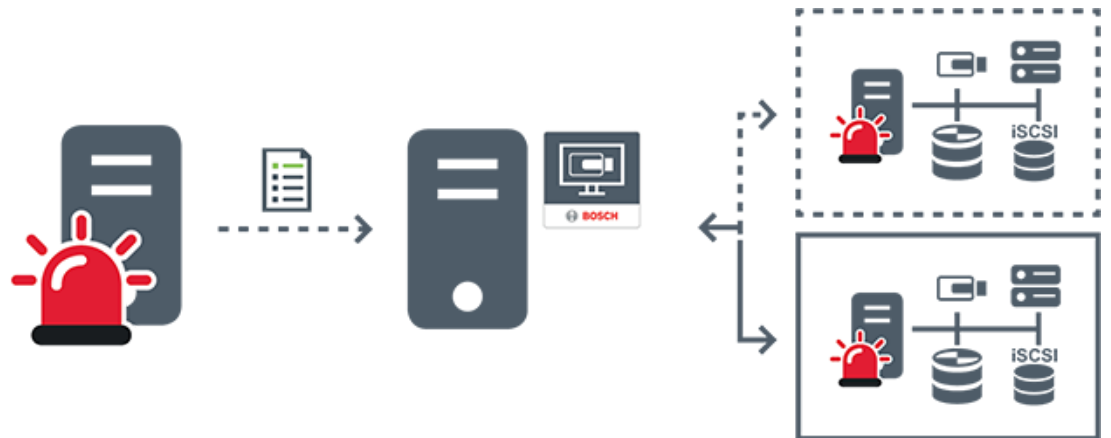

	On demand live, playback, events, alarms - connected
	On demand live, playback, events, alarms - not connected
	Management Server
	Server list
	Operator Client
	Connected BVMS from server list
	Not connected BVMS from server list

Refer to

- *Configuring Server Lookup, page 127*
- *Server list / Address Book page, page 126*
- *Using Server Lookup, page 75*
- *Exporting the Server List, page 128*
- *Importing a Server List, page 128*

4.1.4

Unmanaged site

- A system design option in BVMS with a large number of small subsystems.
- It allows to configure up to 9999 locations in one BVMS Management Server
- Operators can access live and recorded video data from up to 20 sites simultaneously.

- For an easy navigation sites can be grouped in folders or can be placed on maps. Predefined username and password allow operators to quickly connect to a site .
- The unmanaged site concept supports IP based BVMS system as well as analog DVR solutions:
 - Bosch DIVAR AN 3000 / 5000 analog recorders
 - DIVAR hybrid recorders
 - DIVAR network recorders
 - DIP 3000/7000 units IP based recording
 - Single BVMS Management Server System

Adding a site for central monitoring only requires a license per site and is independent of the number of channels in the site.

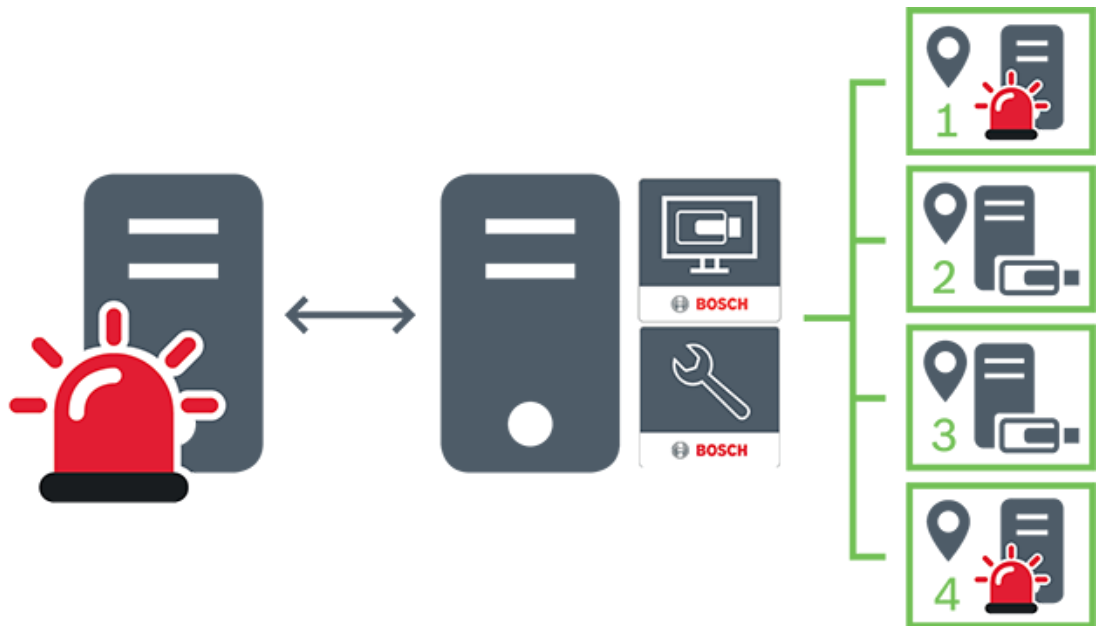

	Live, playback, events, alarms
	On demand live and playback video traffic
	Management Server
	Operator Client / Configuration Client
	site
	DVR

Refer to

– *Adding an unmanaged site manually, page 206*

4.2 Recording

This chapter explains the different recording and replay related functions in the system.

4.2.1 Automated Network Replenishment (ANR)



Notice!

BVMS Viewer offers only basic features. Advanced features are included in BVMS Professional. For detailed information about the different BVMS editions refer to www.boschsecurity.com and the BVMS Quick Selection Guide: [BVMS Quick Selection Guide](#).

Intended use

When a failure of the network or the central storage occurs, the ANR function ensures that the encoder transmits the locally buffered recording of the missing time period to the central storage after the failure is fixed.

The following graphic shows the transmission of video data after a network or storage failure is fixed.

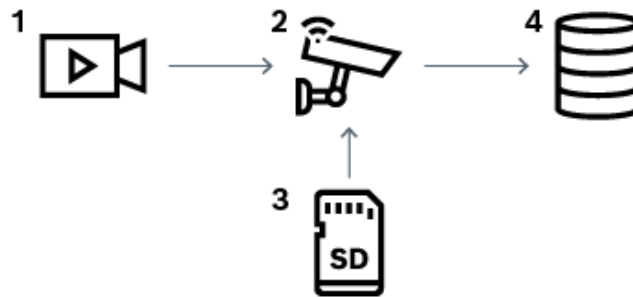

1	Video
2	Encoder, IP network
3	SD card (ring buffer)
4	iSCSI target (central storage)

Example: Work around network failure

If the network fails unexpectedly, the ANR function completes the central storage with the locally buffered recording when the network is available again.

Example: Store video data when network is not available

A subway has no network connection to the central storage when located between stations. Only during regular stops the buffered recording can be transmitted to the central storage. Ensure that the time period that is required for transferring the buffered recording, does not exceed the time period of a stop.

Example: ANR for alarm recording

The pre-alarm recording is stored locally. Only in case of an alarm, this pre-alarm recording is transmitted to the central storage. If no alarm occurs, the obsolete pre-alarm recording is not transmitted to the central storage and, hence, does not burden the network.

Limitations



Notice!

You cannot use playback from the local storage media when the passwords for `user` and `live` are set on the encoder. Remove the passwords if required.

The ANR function only works with VRM recording.

The ANR function does not work with an encoder for which a secure connection for live display is configured.

You must have configured the storage media of an encoder to use the ANR function.

The encoder for which you configure the ANR function, must have firmware version 5.90 or later. Not all encoder types support the ANR function.

You cannot use the ANR function with dual recording.

Your iSCSI storage system must be properly configured.

The following list contains the possible reasons if you cannot configure the ANR function:

- Encoder is not reachable (wrong IP address, network failure, etc.).
- Storage media of the encoder not available or read-only.
- Wrong firmware version.
- Encoder type does not support the ANR function.
- Dual recording is active.

Refer to

- *Configuring an iSCSI device, page 188*
- *Configuring the storage media of an encoder, page 84*
- *Configuring the ANR function, page 287*

4.2.2

Dual / failover recording

Intended use

A Primary VRM manages the normal recording of the cameras of your system. You use a Secondary VRM to achieve dual recording of your cameras.

Dual recording allows you to record video data from the same camera to different locations. Dual recording is usually performed with different stream settings and recording modes. As a special case of dual recording you can configure mirrored recording: the same video signal is recorded twice to different locations.

Dual recording is realized by using 2 VRM servers managing multiple iSCSI devices that can be located at different locations.

A Secondary VRM can manage the secondary recording for multiple Primary VRMs.

The user can select between the recordings managed by the Primary VRM and those managed by the Secondary VRM. For a single camera, the user can switch over to the recordings of the Secondary / Primary VRM. The user can also display the recordings of the same camera managed by Primary VRM and Secondary VRM simultaneously.

For dual recording, you must install a Secondary VRM during Setup.

A Failover VRM is used for continuing the recording of a failed Primary VRM or a failed Secondary VRM computer.

The following graphic shows an example of a dual recording scenario:

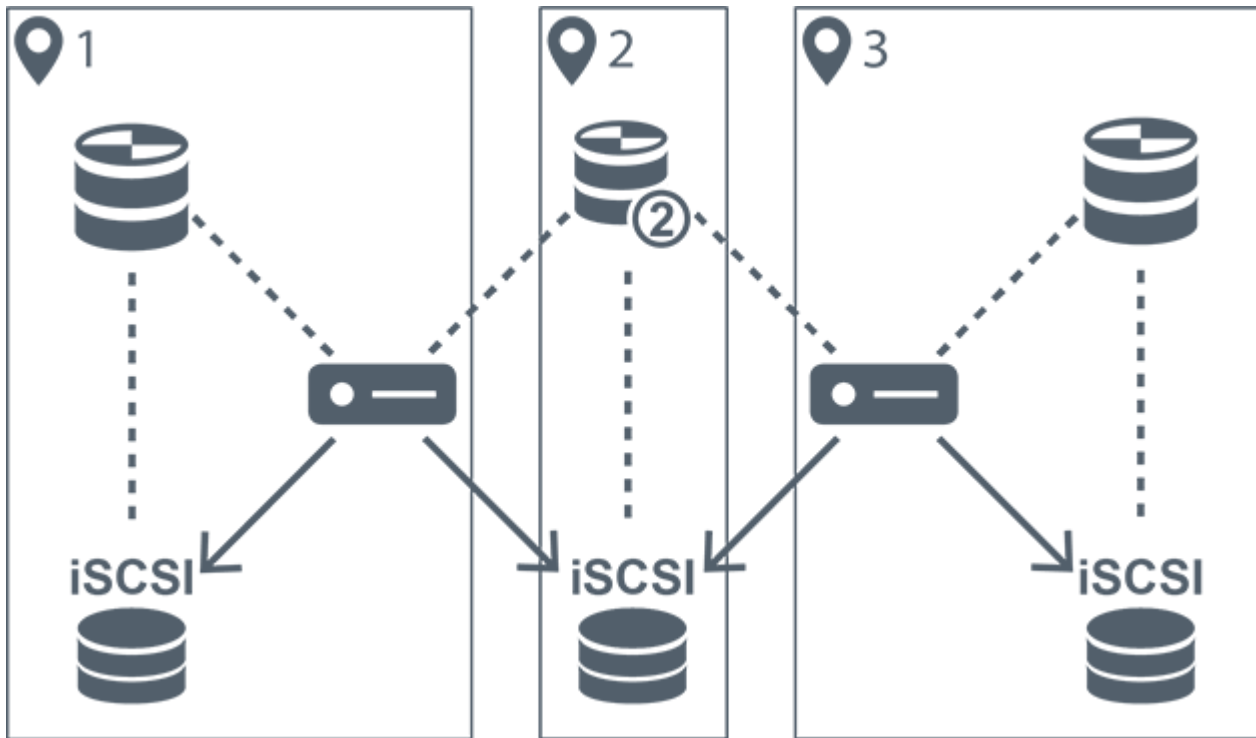

1	Site 1		Encoder
2	Central site		iSCSI storage device
3	Site 2	Control connection
	Primary VRM	→	Video stream
	Secondary VRM		

Limitations

You cannot use dual recording together with ANR.
 Cameo SDK only supports the playback of primary recording.

Refer to

- *Configuring dual recording in the Camera Table, page 287*
- *Adding a Mirrored VRM manually, page 173*
- *Adding a Failover VRM manually, page 172*
- *Cameras page, page 271*

4.2.3

VRM recording modes

This chapter shows graphics to illustrate the possible VRM recording modes.



List of possible VRM recording modes:

- Primary VRM recording
- Mirrored VRM recording
- Secondary VRM recording

- Failover VRM recording
For ANR recording, see chapter *Automated Network Replenishment (ANR)*, page 27.

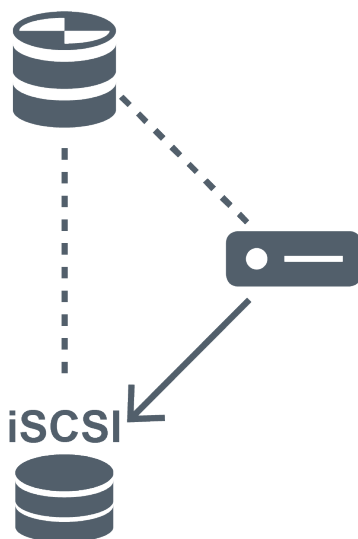
Primary VRM recording



	Primary VRM		Control connection
	iSCSI storage device		Video stream
	Encoder		

Mirrored VRM recording

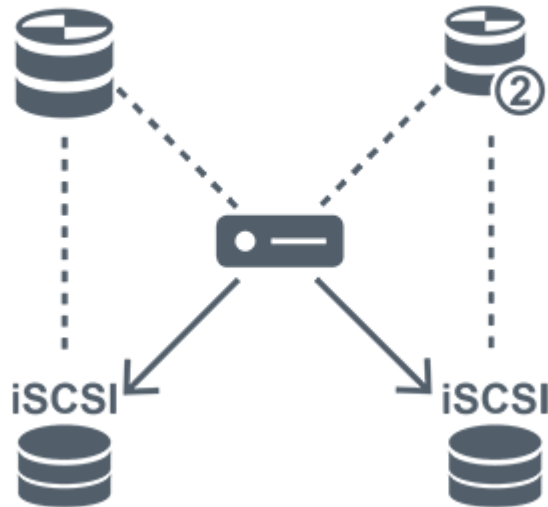

	Primary VRM		Secondary VRM
	iSCSI storage device	Control connection
	Encoder	→	Video stream

Secondary VRM recording

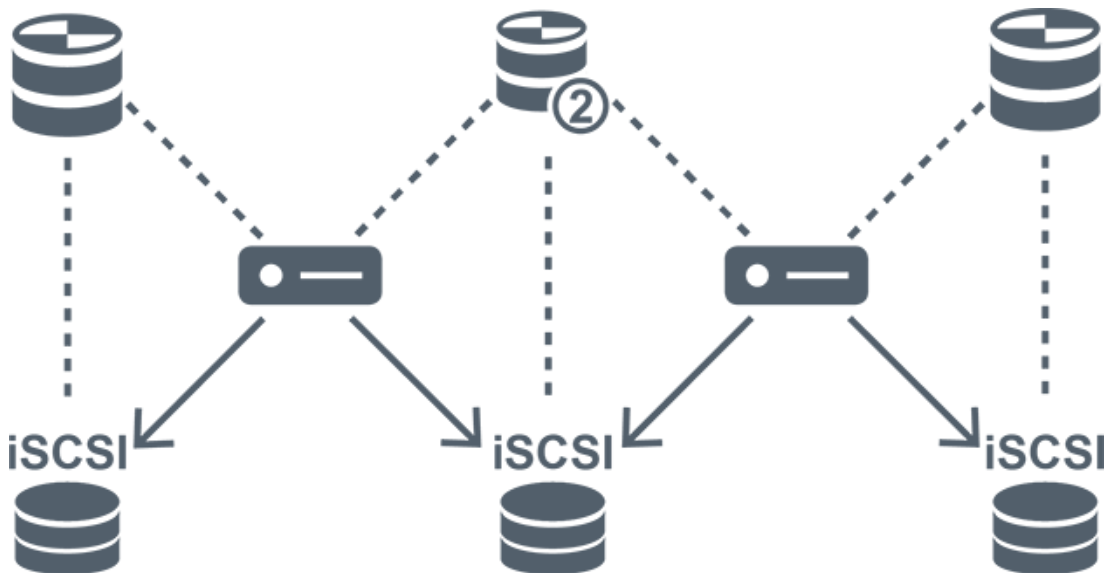

	Primary VRM		Secondary VRM
	iSCSI storage device	Control connection



Failover VRM recording

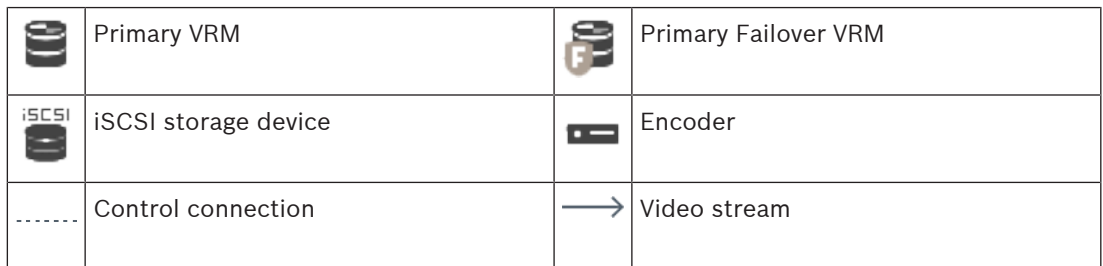
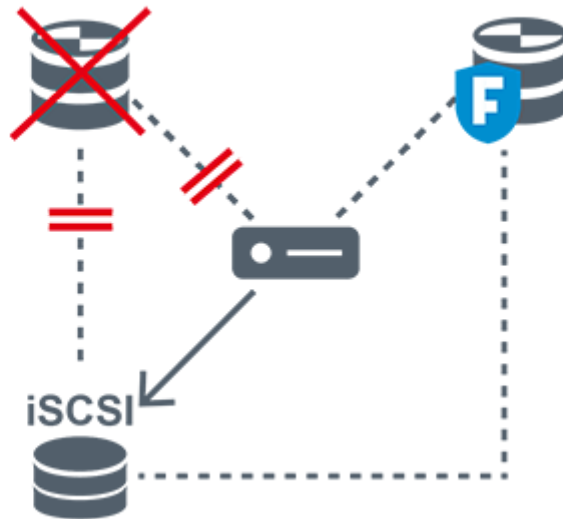

4.2.4

Playback of VRM recording sources

The following graphics show Image panes with playback from all possible VRM recording sources. Each graphic displays the storage device, the VRM instance (if available), and a section of an Image pane as example of the playback. If applicable, the recording source is indicated by an appropriate icon on the Image pane bar.

- *Playback of single recording, page 32*
- *Playback of dual VRM recording, page 34*
- *Playback of Primary VRM recording with optional Failover VRM, page 35*
- *Playback of Secondary VRM recording with optional Failover VRM, page 37*
- *Automatic Network Replenishment, page 39*

Playback of single recording

This Image pane is displayed when only a Primary VRM is configured. You cannot select another recording source.

----->: If configured for this workstation, playback is provided directly by the iSCSI storage device.







 iSCSI	iSCSI storage device
 Primary VRM	Primary VRM

Playback of dual VRM recording

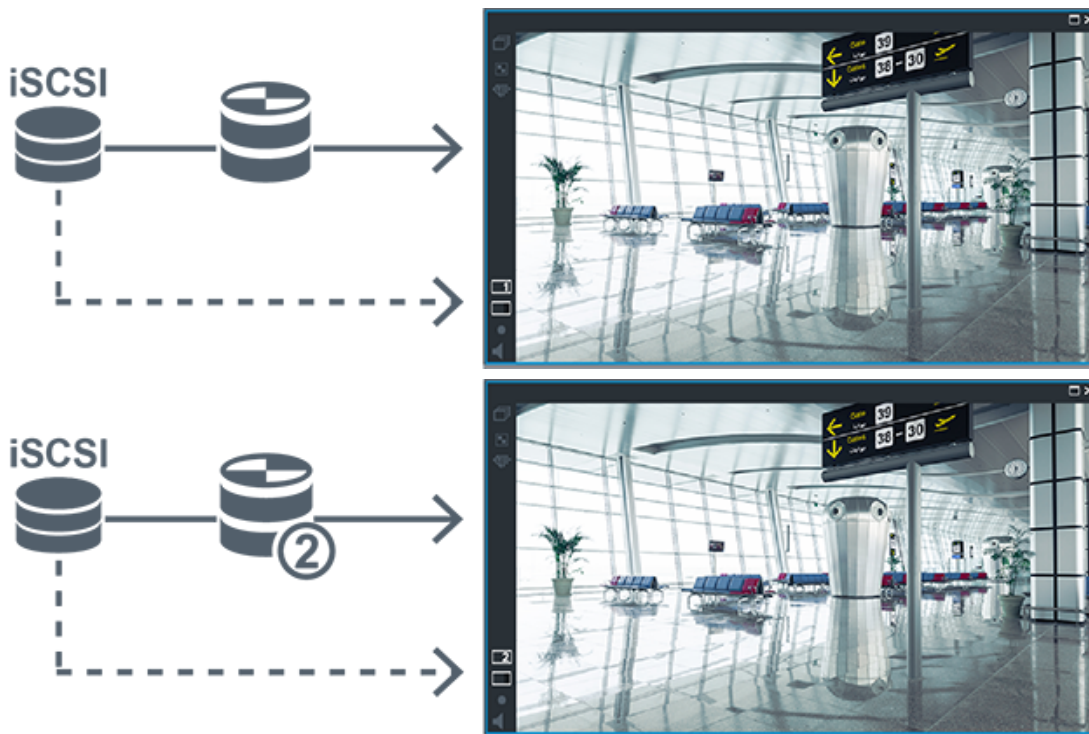
A Primary VRM and a Secondary VRM are configured. Click the recording source icon to display primary or secondary playback.

If configured for this workstation, playback is provided directly by the iSCSI storage device.



	iSCSI storage device
	Primary VRM
	Secondary VRM

Playback of Primary VRM recording with optional Failover VRM

While the Primary VRM is working, it provides playback. The Failover VRM runs in idle state. If configured for this workstation, playback is provided directly by the iSCSI storage device. If a Secondary VRM or ANR recording is configured, you can switch the recording source.





When the Primary VRM is not connected, the configured Failover VRM provides playback. Close the Image pane and display the camera again in an Image pane:



When the Primary VRM and the optional Primary Failover VRM are both not connected, the encoder provides playback. Close the Image pane and display the camera again in an Image pane:



	iSCSI storage device
	Primary VRM

	Primary Failover VRM
	Encoder

Encoder playback can only access a limited recording period.

Playback of Secondary VRM recording with optional Failover VRM

While the Secondary VRM is working, it provides playback. The Failover VRM runs in idle state. If configured for this workstation, playback is provided directly by the iSCSI storage device.



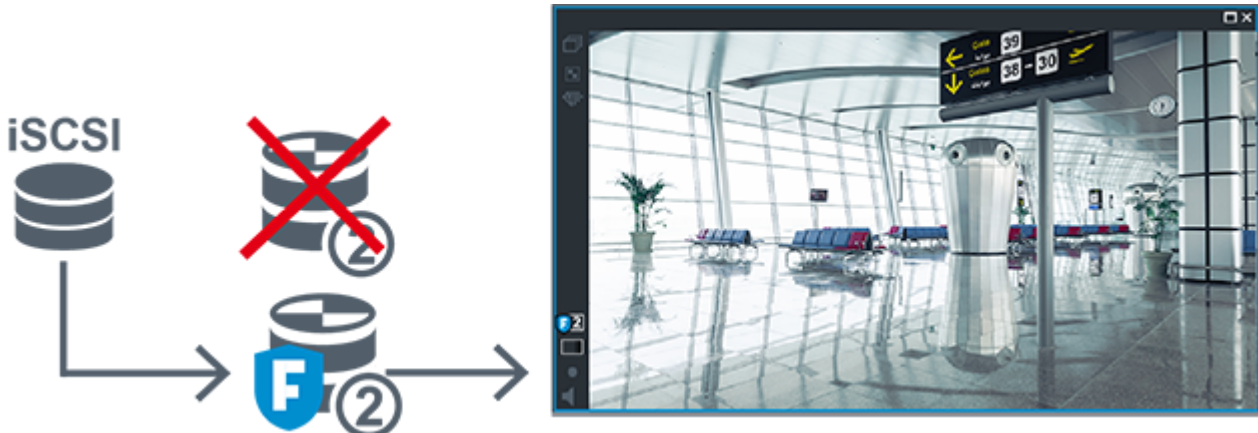

When the Secondary VRM is not connected, the configured Failover VRM provides playback. Close the Image pane and display the camera again in an Image pane:



When the Secondary VRM and the optional Secondary Failover VRM are both not connected, the encoder provides playback. Close the Image pane and drag the camera again to an Image pane:



	iSCSI storage device
	Primary VRM

	Secondary Failover VRM
	Encoder



Encoder playback can only access a limited recording period.

Automatic Network Replenishment

ANR is configured. Click the recording source icon to display primary playback (primary failover playback, primary encoder playback) or ANR playback.

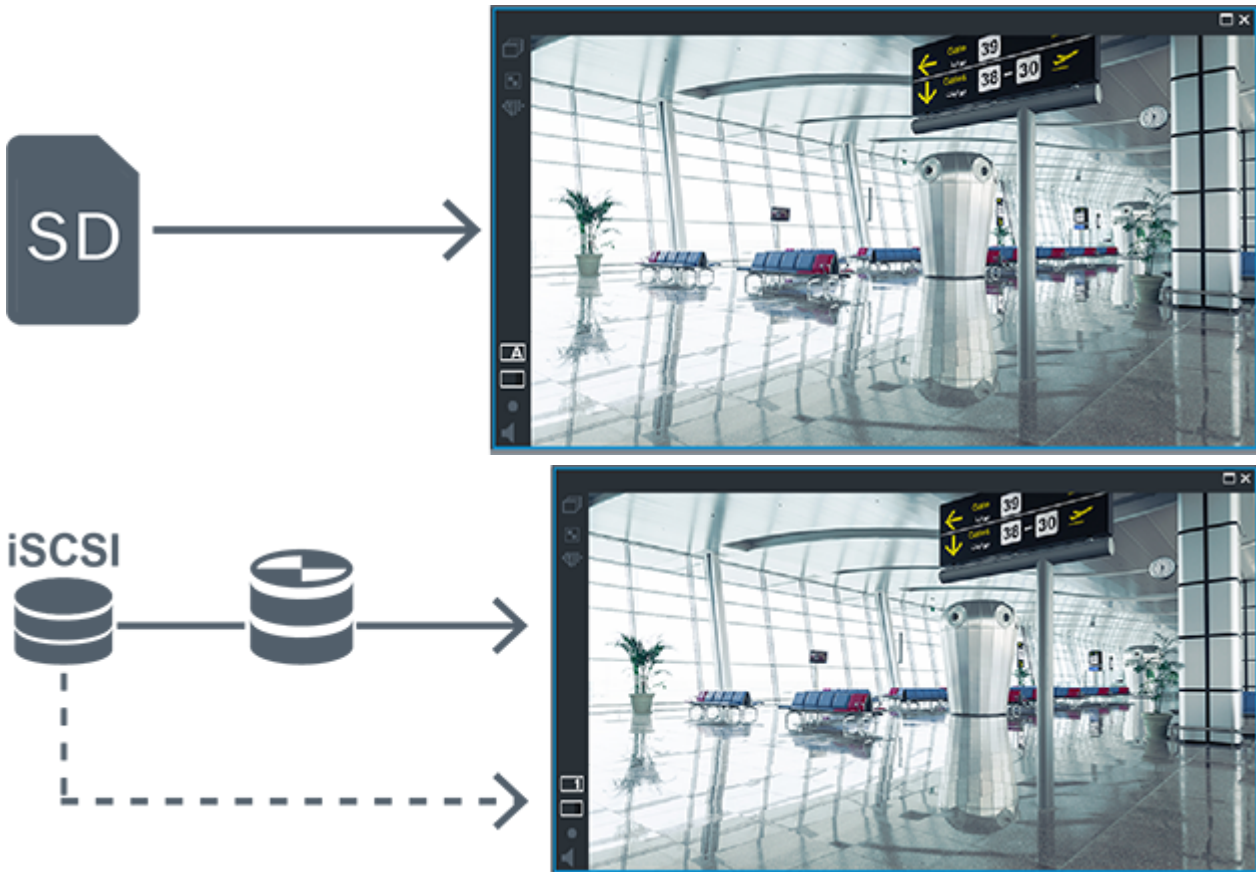
If configured for this workstation, playback is provided directly by the iSCSI storage device.



	iSCSI storage device
	Primary VRM
	SD card

4.2.5

Overview of the storage related events

This chapter describes the different storage related events.

Buffer Storage State

When a failure of the network or the central storage occurs, the ANR function ensures that the encoder transmits the locally buffered recording of the missing time period to the central storage after the failure is fixed.

The buffer storage states are:

- **Storage State Unknown**
- **Storage State OK**
- **Storage State Critical Buffer Fill Level**
- **Storage State Failure**

Buffer Storage Overflow

This event indicates that the storage buffer is already full and the recording is not transmitted to the central storage anymore.

Storage State / Secondary Storage State

The **Storage State** indicates the status of the connection between a camera and the central storage. The **Storage State Failure** event is triggered if the camera loses the connection to the central storage. If the disconnection only lasts a short moment, this event does not necessarily indicate that video data is lost.

The storage states are:

- **Storage State Unknown**
- **Storage State OK**
- **Storage State Failure**

Recording monitor state / Secondary recording monitor state

This event indicates a recording monitoring. As long as the camera can buffer recording in the RAM, no alarm is triggered. The **Recording monitor state recording loss** event is only triggered if within the last two minutes video data can no longer be buffered in the RAM and is lost. The event also indicates the time period when video data was lost.

The recording monitor states are:

- **Recording monitor state unknown**
- **Recording monitor state ok**
- **Recording monitor state recording loss**

Refer to

- *Automated Network Replenishment (ANR), page 27*
- *Configuring events and alarms, page 302*

4.3

Alarm handling

Alarms can be individually configured to be handled by one or more user groups. When an alarm occurs, it appears in the Alarm List of all users in the user groups configured to receive that alarm. When any one of these users starts to work on the alarm, it disappears from the Alarm List of all other users.

Alarms are displayed on a workstation's alarm monitor. This behavior is described in the following paragraphs.

Alarm flow

1. An alarm occurs in the system.
2. Alarm notifications appear in the Alarm Lists of all users configured for this alarm. Alarm video is immediately displayed on configured monitors. If it is an automatically displayed alarm (auto pop-up), the alarm video is also automatically displayed on the Operator Client workstation's alarm monitors.
If the alarm is configured as an auto-clear alarm, the alarm is removed from the Alarm List after the auto-clear time (configured in the Configuration Client).
On monitors, any quad views from VIP XDs are temporarily replaced by full-screen displays.
3. One of the users accepts the alarm. The alarm video is then displayed on this user's workstation (if it is not already displayed via auto pop-up). The alarm is removed from all other Alarm Lists and alarm video displays.
4. The user who accepted the alarm invokes a workflow that can include reading an action plan and entering comments. This step is optional - requirements for workflow can be configured by the administrator.

5. Finally, the user clears the alarm. This removes the alarm from his Alarm List and alarm display.
On a monitor group, the monitors return to the cameras that were displayed before the alarm occurred.

Alarm Image window

1. To display alarm video, the Alarm Image window replaces the Live or Playback Image window on the monitor that has been configured for alarm display.
2. Each alarm gets a row of Image panes. Up to 5 Image panes can be associated with each alarm. These Image panes can display live video, playback video, or maps.
On a monitor group, each alarm can call up cameras on a row of monitors. The number of cameras in the row is limited by the number of columns in the monitor group. Monitors in the row that are not used for alarm video can be configured to either continue with their current display or to display a blank screen.
3. Higher priority alarms are displayed above lower priority alarms on both monitor rows and the Operator Client workstation display alarm rows.
4. If the Alarm image window is completely full of Alarm image rows and an additional alarm must be displayed, the lowest priority alarms "stack up" in the bottom row of the Alarm image window. You can step through the stacked alarms with the controls at the left side of the alarm row.

You can step through the alarm stacks on monitor groups with control buttons in the **Monitors** window of the Operator Client workstation display. Monitors in alarm are indicated by red icons with blinking "LEDs".

The alarm title, time, and date can be optionally be displayed on all monitors, or only the first monitor in the alarm row.

5. For equal priority alarms, the administrator can configure the order behavior:
 - Last-in-First-out (LIFO) mode: in this configuration, new alarms are inserted *above* older alarms of the same priority.
 - First-in-First-out (FIFO) mode; in this configuration, new alarms are inserted *below* older alarms of the same priority.
6. An alarm's Image row can appear in the Alarm Image window in one of two ways:
 - When it is generated (auto pop-up). This occurs when the alarm priority is higher than display priority.
 - When the alarm is accepted. This occurs when the alarm priority is lower than display priority.

Auto pop-up alarms

Alarms can be configured to automatically display (pop up) in the Alarm Image window, based on the alarm priority. Each user group's live and playback displays are also assigned priorities. When alarms are received with priority higher than that of the user's display, the alarm automatically displays its alarm row in the Alarm Image window. If the Alarm Image window is not currently displayed, it automatically replaces the Live or Playback Image window on the alarm-enabled monitor.

Although auto pop-up alarms are displayed in the Alarm Image window, they are not automatically accepted. They can be displayed on multiple users' displays simultaneously. When a user accepts an auto pop-up alarm, it is removed from all other users Alarm Lists and alarm displays.

Alarm handling in case of shutdown

On a server shutdown all active alarms are preserved. The alarms are restored and reappear in the **Alarm List** window, when the system restarts.

Alarms in the state **Accepted** or **Workflow** are automatically set back to the state **Active** when the system restarts. Comments entered for alarms in the state **Workflow** are preserved.

**Notice!**

The alarm data is automatically saved every minute, so the maximum data loss is the data accumulated in one minute.

Refer to

- *Configuring the pre- and post-alarm duration for an alarm, page 307*

4.4

ONVIF event mapping

**Notice!****Be aware that this feature is soon end of life.**

Use the ONVIF Camera Event Driver Tool for easy ONVIF event mapping.

See *Starting ONVIF Camera Event Driver Tool from Configuration Client, page 202*.

Intended use

Intended use is the mapping of ONVIF events to BVMS events. ONVIF events can then trigger BVMS alarms and recording.

You can define default event mappings valid only for a specific ONVIF device, for all ONVIF devices of the same manufacturer and model, or for all ONVIF devices of the same manufacturer. Default event mappings are automatically assigned to all affected ONVIF encoders that are added using the BVMS Scan Wizard or are added manually.

When you add an ONVIF encoder to the BVMS configuration without a connection to this ONVIF encoder, no event mappings are assigned. You can update such an ONVIF encoder with event mappings from an ONVIF encoder of the same manufacturer and/or model that you already have added.

You define event mappings specific for each of the following sources:

- ONVIF encoder
- Cameras of this ONVIF encoder
- Relays of this ONVIF encoder
- Inputs of this ONVIF encoder

Example

In an ONVIF camera a motion detection event occurs. This event shall trigger a **Motion Detected** event in BVMS.

To achieve this, you configure for this ONVIF camera:

- ONVIF topic (`MotionDetection`)
- ONVIF data item (`motion`)
- ONVIF data type (`boolean`)
- ONVIF data value (`true`)

Note: It is not sufficient to only configure the **Motion Detected** event. Please configure also the **Motion Stopped** event. You always must configure a pair of events.

Import or export of a Mapping Table

You can export a Mapping Table on a computer where you have created it and import this Mapping table on another computer where the required mapping table is not available.

Troubleshooting

You can create log files for troubleshooting.

Refer to

- *Configuring an ONVIF mapping table, page 230*
- *Enabling logging for ONVIF events, page 354*
- *ONVIF Encoder Events page, page 226*

4.5 Inactivity logoff

Intended use

Intended use of inactivity logoff is to protect an Operator Client or Configuration Client during the absence of the operator or administrator.

You can configure per user group that Operator Client shall be logged off automatically after a specified time period without activity.

For Configuration Client no user groups are available. The inactivity logoff setting is valid only for the **admin** user.

All operations with keyboard, mouse and CCTV keyboard affect the specified time period for inactivity logoff. Automatic activities of Operator Client do not affect the time period.

Automatic activities of Configuration Client like firmware upload or iSCSI setup prevent the inactivity logoff.

You can also configure the inactivity logoff for a BVMS Web Client.

Short before an inactivity logoff, a dialog box reminds the user to actively prevent the inactivity logoff.

The Logbook records an occurred inactivity logoff.

Example

If a workstation is located in a public area, the inactivity logoff minimizes the risk that on an unattended workstation Operator Client is accessed by an unauthorized person.

An administrator group member shall logoff automatically after inactivity but a desk officer (operator group) might just watch video without operating the system and does not want an inactivity logoff.

Limitations

Client SDK activity does not support the inactivity logoff, this means that the activity of Client SDK does not affect the specified time period.

Refer to

- *Options dialog box (Settings menu), page 119*
- *Operator Features page, page 319*

4.6 Version independent Operator Client

For Compatibility mode both Operator Client and Management Server must have a version later than 5.5.

A user of Operator Client can successfully log on to a Management Server where a previous software version is running.

If the server provides a newer configuration than available on the Operator Client workstation, this configuration is automatically copied to the Operator Client workstation. The user can decide to download the new configuration.

Operator Client provides a reduced feature set and is connected to this Management Server. The following Management Server related features are available after logon to a Management Server with a previous version:

- User preferences
- Start manual recording
- Display of device states

- Toggling relay states
- Searching the Logbook
Search for events is not possible.
- Server Lookup
- Remote export

4.6.1 Working with Compatibility Mode



: This Operator Client state displays in case of compatibility mode.

In version later than 5.5, the Operator Client will work in compatibility mode if the version of the Management Server is lower than the version of the Operator Client.

In version later than 10.0, the Operator Client will work in compatibility mode in case of the following:

- Not all communication services could be connected by Operator Client.
- Example: The Management Server is up and running, but WebServiceHost is down.
- There are changes within the communication interface between Operator Client and Management Server

Only semantic interface changes or partial drop of services may cause that some functionalities can be missing in the Operator Client.

4.7 Viewing modes of a panoramic camera

This chapter illustrates the viewing modes of a panoramic camera which are available in BVMS.

The following viewing modes are available:

- Circle view
- Panorama view
- Cropped view

Panorama and cropped view modes are created by the dewarping process in BVMS. Edge dewarping is not used.

The administrator must configure the mounting position of a panoramic camera in Configuration Client.

You can resize the Image pane of a camera as required. The Image pane ratio is not restricted to the 4:3 or 16:9 aspect ratio.

Refer to

- *Configuring predefined positions and auxiliary commands, page 284*

4.7.1 360° panoramic camera - floor- or ceiling mounted

The following figure illustrates the dewarping of a 360° camera which is floor- or ceiling mounted.

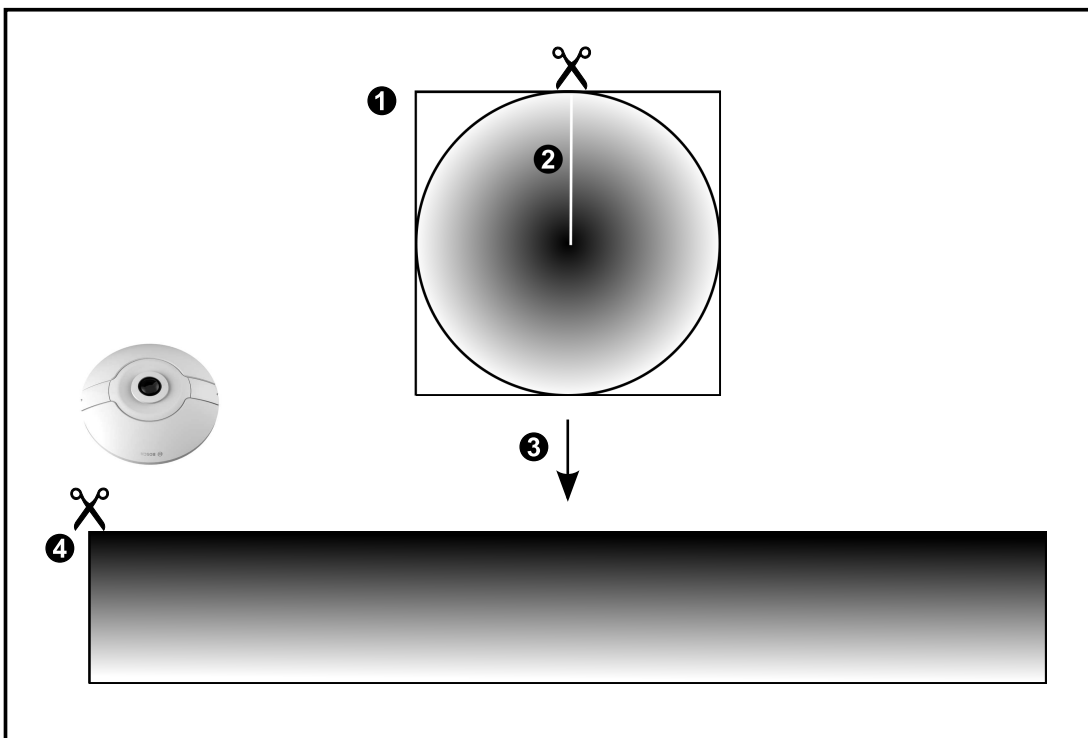
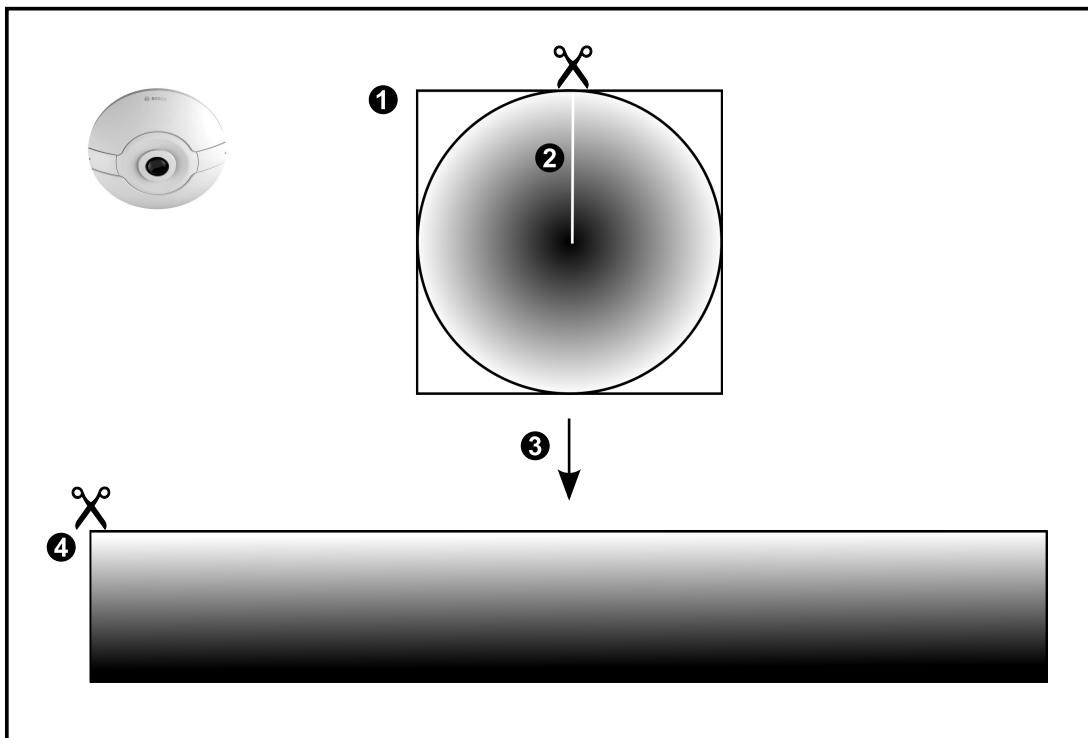

1	Full circle image	3	Dewarping
2	Snipping line (operator can change its position when not zoomed in)	4	Panorama view

4.7.2 180° panoramic camera - floor- or ceiling mounted

The following figure illustrates the dewarping of a 180° camera which is floor- or ceiling mounted.

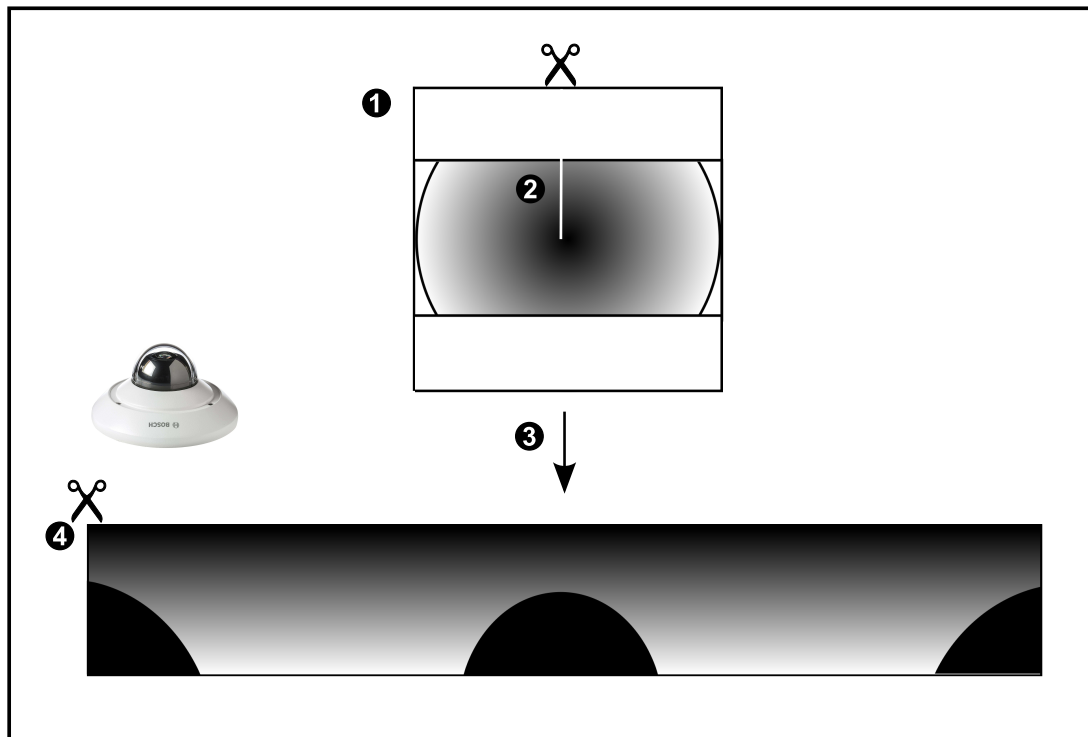
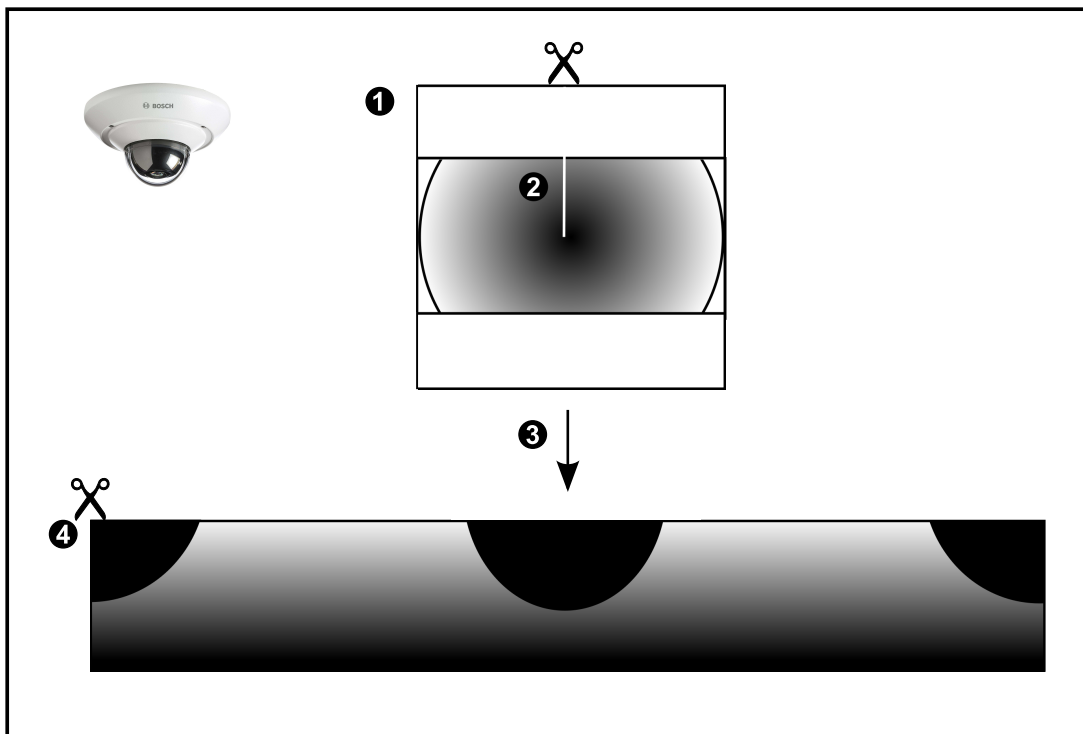

1	Full circle image	3	Dewarping
2	Snipping line (operator can change its position when not zoomed in)	4	Panorama view

4.7.3

360° panoramic camera - wall mounted

The following figure illustrates the dewarping of a 360° camera which is wall mounted.

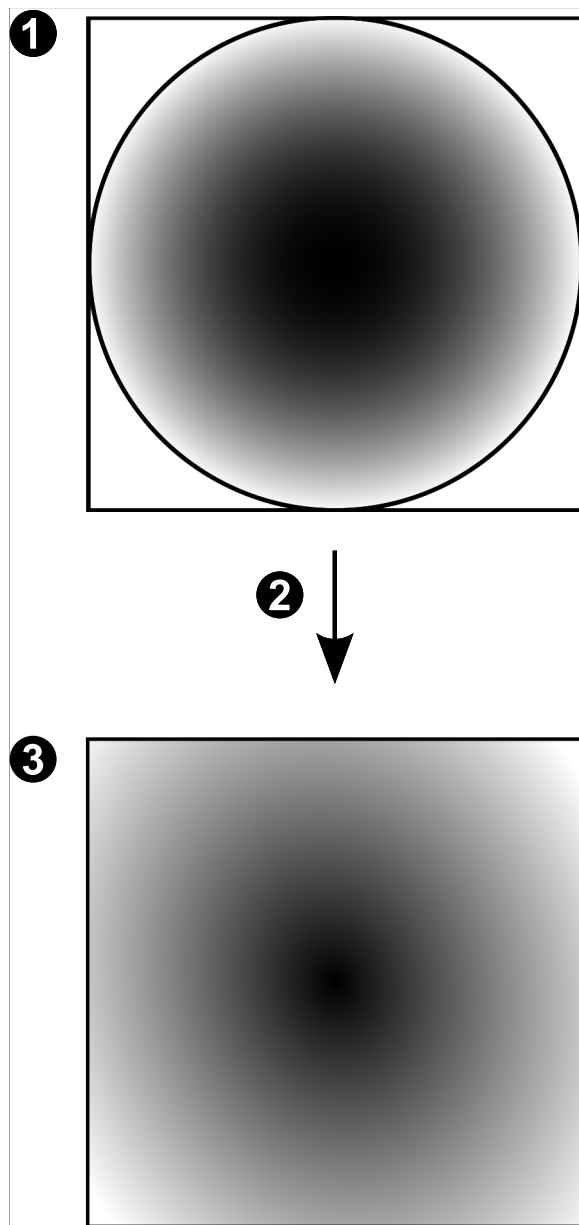

1	Full circle image	3	Panorama view
2	Dewarping		

4.7.4 180° panoramic camera - wall mounted

The following figure illustrates the dewarping of a 180° camera which is wall mounted.

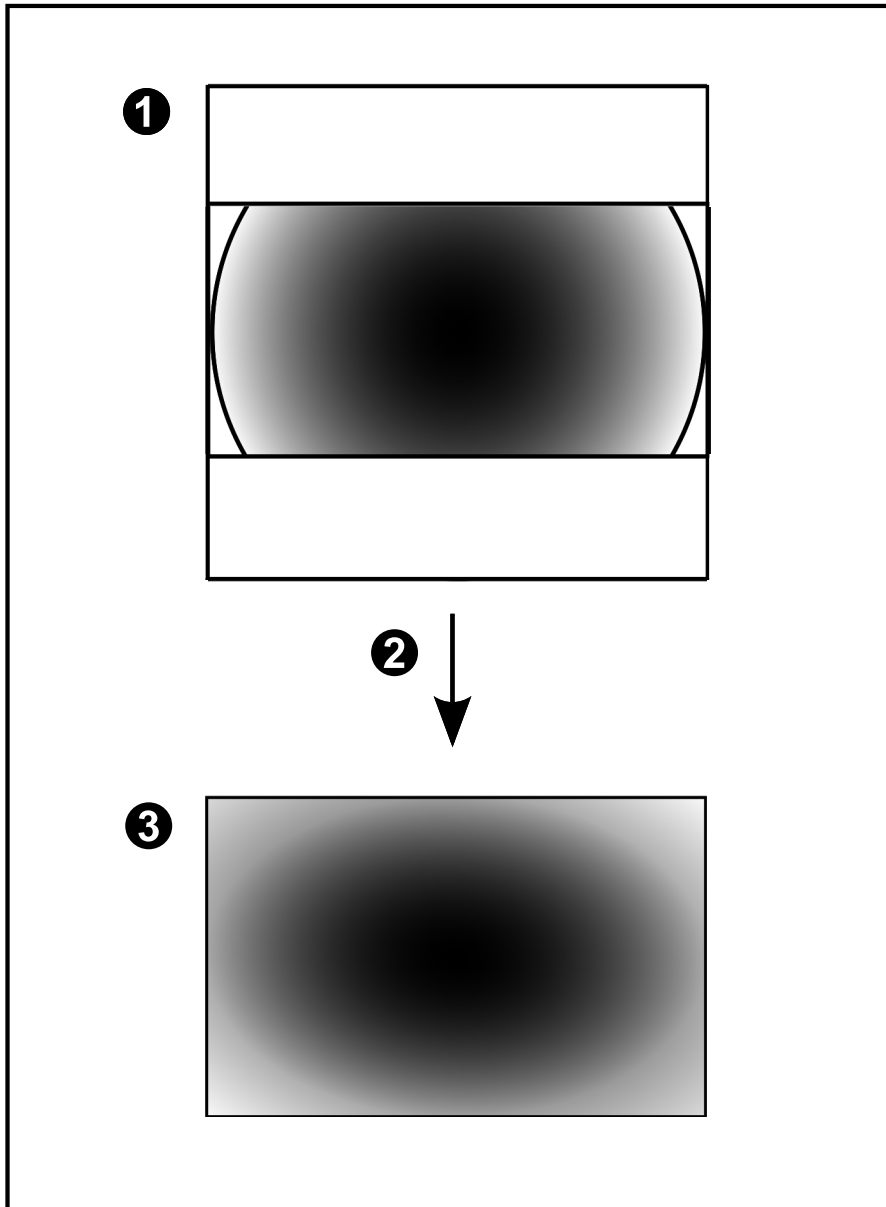

1	Full circle image	3	Panorama view
2	Dewarping		

4.7.5 Cropped view on a panoramic camera

The following example figure illustrates the cropping of a 360° camera which is floor- or ceiling mounted.

The rectilinear section used for cropping is fixed. You can change the section in the cropped Image pane using the available PTZ controls.

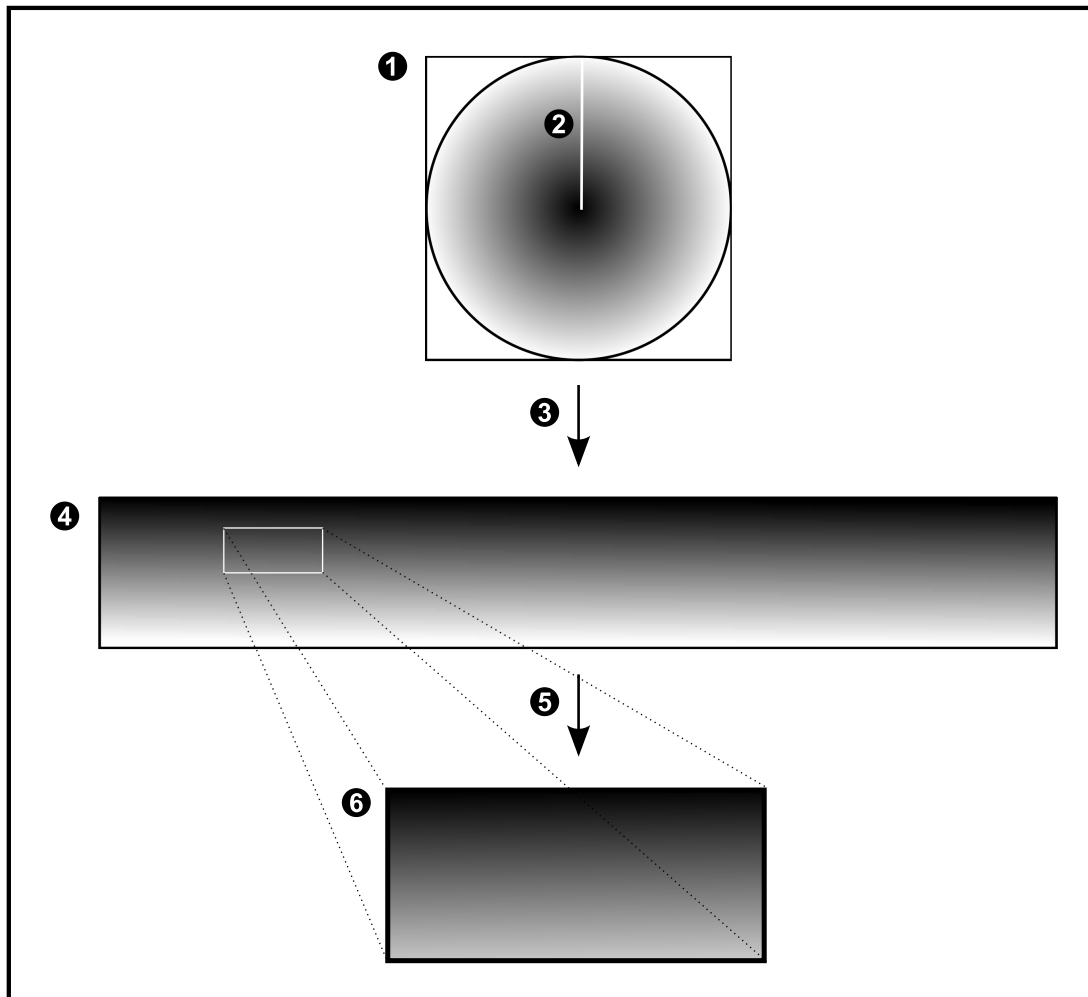

1	Full circle image	4	Panorama view
2	Snipping line (operator can change its position when not zoomed in)	5	Cropping
3	Dewarping	6	Cropped Image pane

4.8 SSH Tunneling

BVMS provides remote connectivity utilizing Secure Shell (SSH) tunneling.

SSH tunneling constructs an encrypted tunnel established by an SSH protocol/socket connection. This encrypted tunnel can provide transport to both encrypted and un-encrypted traffic. The Bosch SSH implementation also utilizes Omni-Path protocol, which is a high performance low latency communications protocol developed by Intel.

Technical aspects and restrictions

- SSH tunneling utilizes port 5322. This port cannot be modified.
- The SSH Service must be installed on the same server as the BVMS Management Server.
- (Enterprise) user accounts must have a configured password. (Enterprise) user accounts without a password cannot log on utilizing a SSH connection.
- Local storage cameras do not support SSH connection.
- Configuration Client cannot connect remotely via SSH. Configuration Client connection must be done via port mapping.
- Operator Client checks connection with SSH service every 15 seconds. If the connection is interrupted, Operator Client retests the connection every minute.

Port mapping

- ▶ Configure one port forwarding for the BVMS Management Server to utilize port 5322 for both internal and external connections.
This is the only port mapping entry that you need to make for the entire system.
BVMS port mapping is not required.

Encrypted communication

After the connection is established via a SSH tunnel, all communications between the BVMS Management Server and a remote client are encrypted.

4.9 Multipathing

BVMS provides multipathing for dual controller systems. Multipath is a fault-tolerance technique that defines more than one physical path between the camera and its iSCSI storage devices through redundant network connections. When using multipathing, recording of video data and replaying video data is possible even in case of an iSCSI controller failure.

Prerequisites and restrictions

- Netapp E2800 dual controller iSCSI unit is installed.
- Firmware 6.43 enables devices recording to E2800 to use alternative paths.
- VRM 3.71 to monitor and log devices with multipathing are enabled.
- Two physical iSCSI ports are configured per controller: either 2x2 RJ45 or 2x2 optical.
- Link speed needs to be 10 Gbit/s in order to achieve full performance.
- The Dual-Simplex mode used in E2700 is not supported anymore.

For more details on installation of DSA E2800 Full Duplex see Installation Manual DSA E-Series E2800.

5 Supported hardware



Notice!

Do not connect a device to more than one BVMS! This can lead to recording gaps and other undesired effects.

You can connect the following hardware to BVMS:

- Mobile video clients like iPhone or iPad via DynDNS
- Various IP cameras, encoders and ONVIF cameras (live only or via Video Streaming Gateway)
 - Connected via network
- Live only encoders with local storage
 - Connected via network
- iSCSI storage devices
 - Connected via network
- Analog cameras
 - Connected to encoders,
- Decoders
 - Connected via network
- Monitors
 - Connected to a decoder, to a Bosch Allegiant matrix, to a BVMS Client workstation
- Bosch Allegiant matrix (Firmware version: 8.75 or greater, MCS version: 2.80 or greater)
 - Connected to a COM port of the Management Server or to a remote computer and to an IP encoder on the network.
- KBD-Universal XF keyboard
 - Connected to a USB port of a BVMS workstation.
- Bosch IntuiKey keyboard
 - Connected to the COM port of a BVMS workstation (Firmware version: 1.82 or greater) or to a hardware decoder (VIP XD).
 - If you connect the keyboard to a workstation, the user can control the complete system with the keyboard. If you connect the keyboard to a VIP XD decoder, the user can only control monitors with the keyboard.
- SMTP E-mail server
 - Connected via network
- POS
 - Connected via network
- ATM
 - Connected via network
- Network monitoring device
 - Connected via network
- I/O modules
 - Connected via network
 - Only ADAM devices are supported.

All devices connected via network are connected to a switch. The computers of the BVMS are also connected to this device.

5.1 Installing hardware

BVMS supports the following hardware components:

- KBD-Universal XF keyboard

- Bosch IntuiKey keyboard
 - Bosch Allegiant matrix with cameras and monitor: Connected to a COM port of one of the computers of the network and to IP encoders connected to the network
 - Encoders with analog cameras
 - Local storage encoders
 - IP cameras and IP AutoDomes
 - Monitors connected to a decoder (monitor groups for alarm processing are possible)
 - DVR Systems with cameras
 - ATM / POS devices
 - I/O modules
- Only ADAM devices are supported.

5.2 Installing a KBD Universal XF keyboard



Notice!

Refer to the Instructions Manual delivered with your KBD-Universal XF keyboard available on the online product catalog.

More information

For more information, software downloads, and documentation, go to www.boschsecurity.com and the corresponding product page.

You can connect the following hardware to BVMS:

- Mobile video clients like iPhone or iPad via DynDNS
- Various IP cameras, encoders and ONVIF cameras (live only or via Video Streaming Gateway)
Connected via network
- Live only encoders with local storage
Connected via network
- iSCSI storage devices
Connected via network
- Analog cameras
Connected to encoders,
- Decoders
Connected via network
- Monitors
Connected to a decoder, to a Bosch Allegiant matrix, to a BVMS Client workstation
- Bosch Allegiant matrix (Firmware version: 8.75 or greater, MCS version: 2.80 or greater)
Connected to a COM port of the Management Server or to a remote computer and to an IP encoder on the network.

5.3 Connecting a Bosch IntuiKey keyboard to BVMS

This chapter provides background information on configuring a Bosch IntuiKey keyboard.

5.3.1 Scenarios for Bosch IntuiKey keyboard connections

You can connect a Bosch IntuiKey keyboard to the COM port of a BVMS workstation (scenario 1) or to a hardware decoder (e.g. VIP XD, scenario 2).

If you connect the keyboard to a BVMS workstation, you can control the complete system. If you connect the keyboard to a decoder, you can only control the analog monitors of the system.

If you connect the keyboard to an Enterprise Operator Client, you can control the cameras of a specific Management Server by first pressing the server key to type in the number of this server and then type the camera number.



Notice!

For connecting the Bosch IntuiKey keyboard with a BVMS workstation, use the specified Bosch cable.

For connecting the Bosch IntuiKey keyboard with a VIP XD decoder, you need a cable which connects a serial COM port of the keyboard with the serial interface of the decoder. See Connecting a CCTV keyboard to a decoder for connections.

Bosch IntuiKey keyboard connected to a BVMS workstation

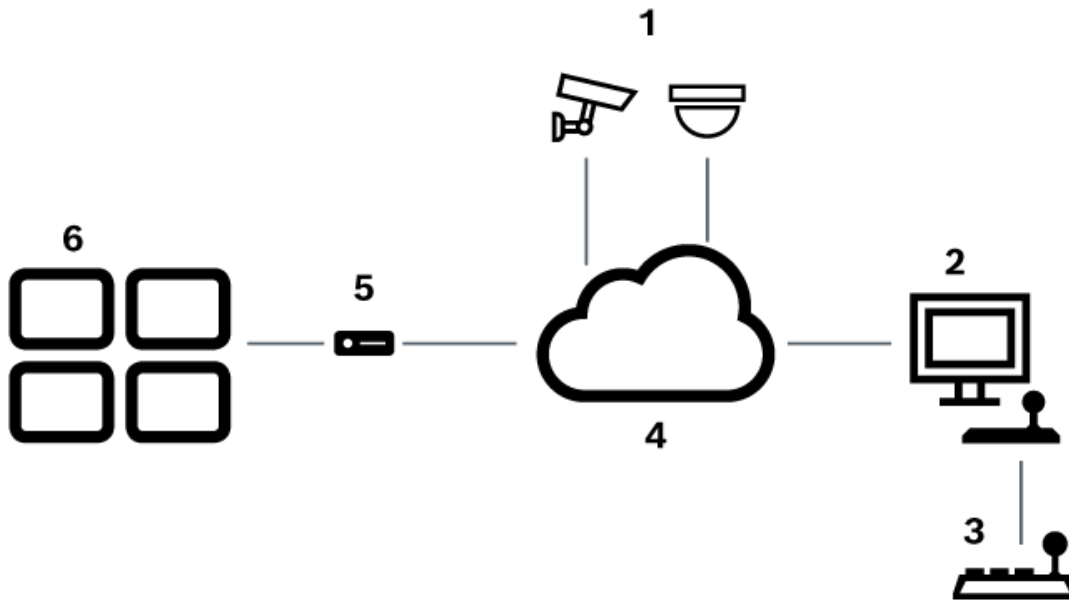

Figure 5.1: Scenario 1: Bosch IntuiKey keyboard connected to a Bosch Video Management System workstation

1	Various cameras connected to network via encoders
2	BVMS workstation
3	Bosch IntuiKey keyboard
4	BVMS network
5	Decoder
6	Monitors

Bosch IntuiKey keyboard connected to a decoder

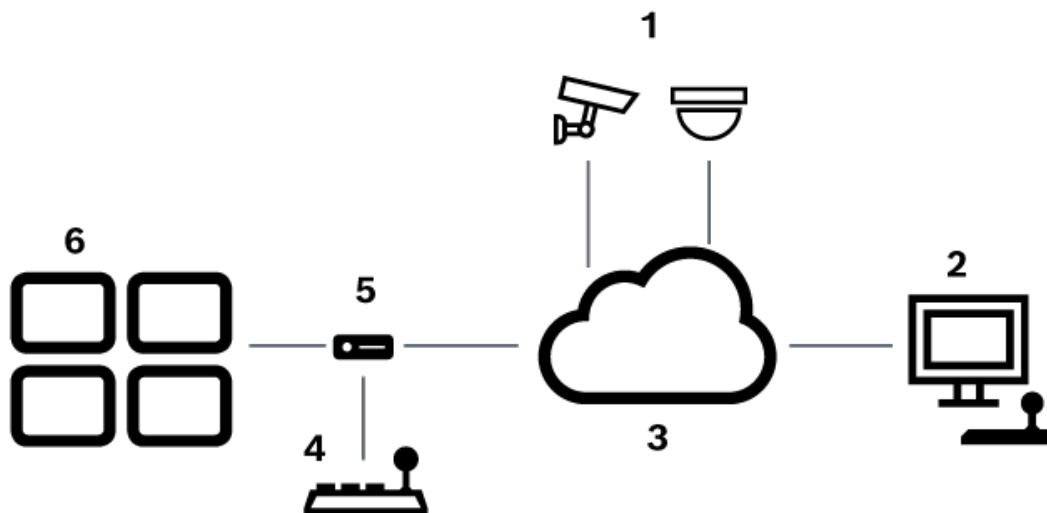

Figure 5.2: Scenario 2: Bosch IntuiKey keyboard connected to a decoder

1	Various cameras connected to network via encoders
2	BVMS workstation
3	BVMS network
4	Bosch IntuiKey keyboard
5	Decoder
6	Monitors

Follow these references to get detailed information on the available windows:

- *Assign Keyboard page, page 152*

Follow these references to get detailed information on the available step-by-step instructions:

- *Configuring a Bosch IntuiKey keyboard (settings page) (workstation), page 135*
- *Configuring a Bosch IntuiKey keyboard (decoder), page 142*
- *Configuring a decoder for use with a Bosch IntuiKey keyboard, page 142*

Refer to

- *Assign Keyboard page, page 152*

5.3.2

Connecting a Bosch IntuiKey keyboard to a decoder

Configuring the decoder

See *Configuring a decoder for use with a Bosch IntuiKey keyboard, page 142* for details.

Connections between COM port and VIP XD decoder

The following table lists the connections between an RS232 adapter and a serial interface of a VIP XD decoder:

RS232 adapter	Serial interface of a VIP XD decoder
1	
2	TX
3	RX
4	
5	GND
6	
7	CTS
8	RTS
9	

The following illustration shows the pinout of a standard RS232 adapter (1) and the pinout of the decoder’s serial adapter (2):

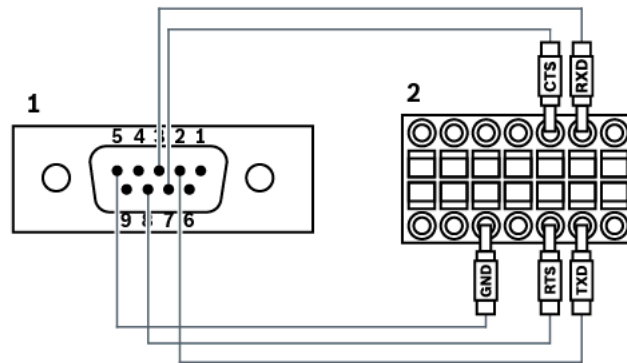

5.3.3

Updating Bosch IntuiKey keyboard firmware

1. On any PC, install the IntuiKey downloader.
2. Start IntuiKey Firmware Upgrade Utility.
3. Connect the keyboard with a valid serial cable (refer to Bosch Support if such a cable is not available) to this PC.
4. On the keyboard, press Keyboard Control softkey, then Firmware Upgrade.
5. Enter the password: 0 and 1 simultaneously.
The keyboard is in bootloader mode.
6. On the PC, click Browse to select the firmware file: for example kbd.s20
7. Set the COM port.
8. Click the Download button to download the firmware.
On the keyboard display, Programming is displayed.
Do not press the Clr key now. Otherwise the keyboard is not usable after restart (see Notice below).
9. Click Browse to select the language: for example 8900_EN_..82.s20
On the keyboard display, Programming is displayed.

10. Close IntuiKey Firmware Upgrade Utility.
11. On the keyboard, press Clr key to exit.
The keyboard restarts. Wait some seconds until the menu for selecting the keyboard language appears.
12. Select the desired language with a softkey.
The default start display appears.

**Notice!**

For starting the bootloader mode directly, you can unplug the power supply from the keyboard, press 0 and 1 simultaneously, plug in the power supply again, release 0 and 1.

5.4

Connecting Bosch Allegiant Matrix to BVMS

The BVMS Allegiant Matrix interface provides seamless access to analog matrix cameras in the Operator Client interface. Allegiant cameras appear almost identical to IP cameras. The only difference is a small grid symbol on the camera to indicate that it is a Allegiant camera. You can display cameras using the same tasks as for IP cameras. They are included both in the Logical Tree and the site maps, and users can add them to their Favorites Trees. In-video-window control for Allegiant-connected PTZ cameras is supported, and you can easily display Allegiant cameras on monitors connected to IP decoders.

BVMS provides an interface to the matrix switch via the Allegiant MCS (Master Control Software) application). The MCS, in this case, runs invisibly in the background. This software provides an efficient, event-driven interface to the Allegiant. It provides fast, real-time event response from the Allegiant to BVMS. So, for example, if a defective coax cable results in video loss in the Allegiant, an immediate notification is sent to BVMS. Also, you can program BVMS to respond to Allegiant alarms.

5.4.1

Bosch Allegiant Connection Overview

To achieve a connection between BVMS and an Allegiant matrix switching system, you configure a control channel between the BVMS and the Allegiant matrix.

Two scenarios are possible:

- Local connection
The Management Server controls the Allegiant matrix.
- Remote connection
A dedicated Bosch Allegiant PC connected to the network controls the Allegiant matrix.

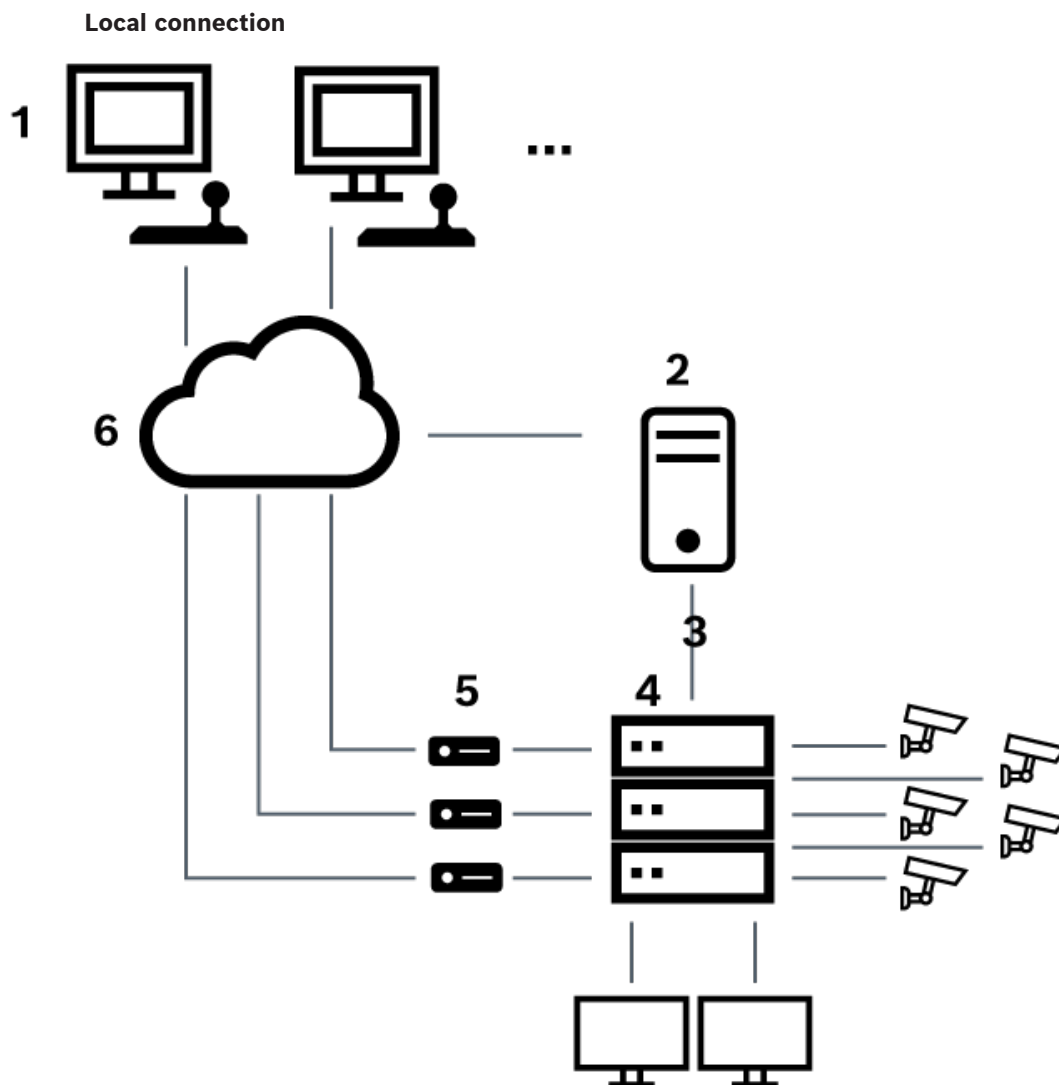

Figure 5.3: Bosch Video Management System local connection to a Bosch Allegiant matrix switch

1	BVMS Client workstations
2	Management Server with Master Control Software
3	RS-232 connection
4	Allegiant matrix
5	encoders
6	Network

Remote connection

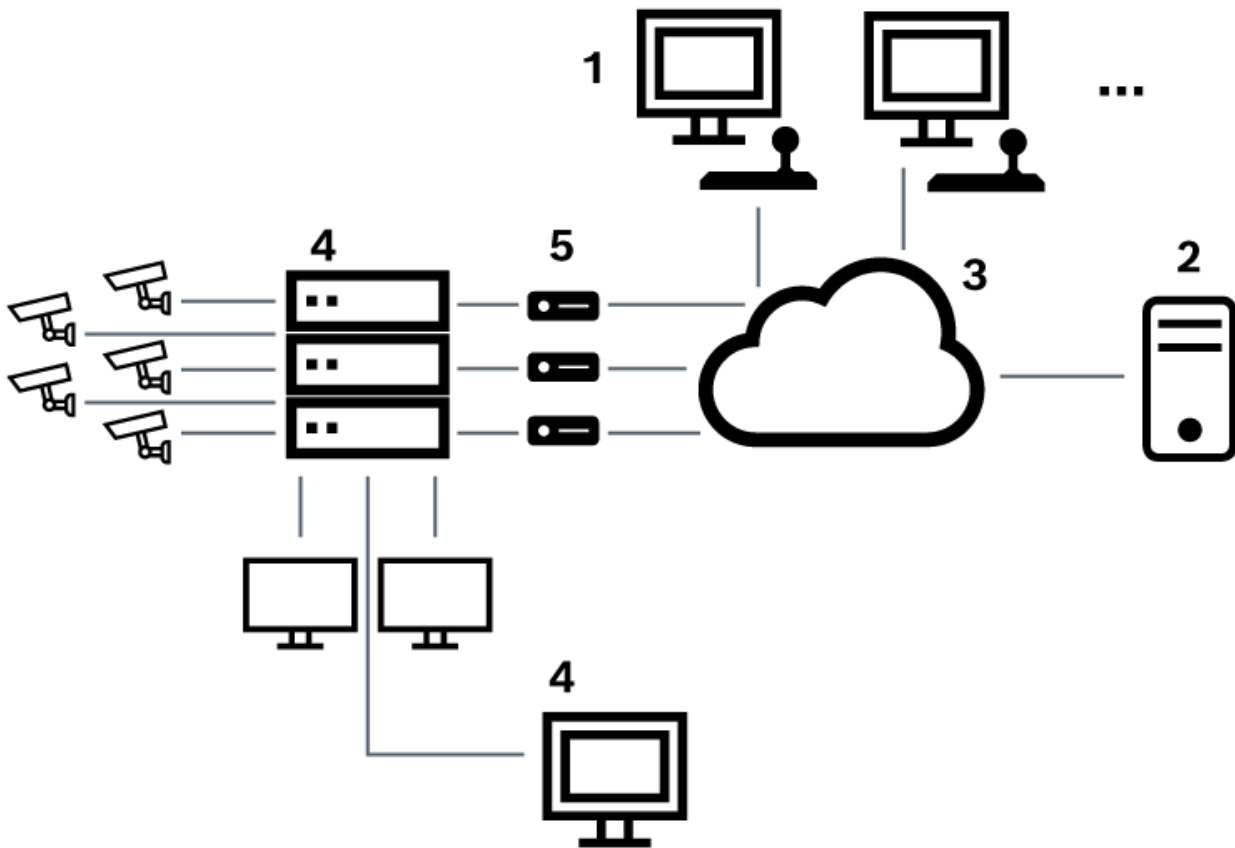

Figure 5.4: Bosch Video Management System remote connection to a Bosch Allegiant matrix switch

1	BVMS Client workstations
2	Management Server with Master Control Software
3	Network
4	Allegiant PC with Master Control Software
5	RS-232 connection
6	encoders
7	Allegiant matrix

5.4.2

Configuring the control channel

Perform the following tasks to configure the control channel:

- Wiring
- Installing the software
- Creating Allegiant configuration file
- Adding the Allegiant matrix to BVMS
- Configuring user names

Wiring

To configure the control channel between BVMS and the Allegiant matrix, connect one PC through an RS-232 serial port to the Allegiant's console port (use the specified Bosch cable for connection). This can be the BVMS Management Server, or any other PC on the network.

Installing Allegiant Master Control Software

1. Stop the Management Server service if running (**Start > Control Panel > Services > Right-click BVMS Management Server > Stop**)
2. Install the Allegiant Master Control Software on the Management Server and on the Allegiant PC (if present).
3. On an remote Allegiant PC configure it to start the Allegiant Network Host program (Id_alghw.exe) on startup. This starts the necessary Allegiant services to allow other PCs on the network to access the Allegiant. The software runs invisibly. It is not necessary to have a dongle attached to this computer.
To have the service started on computer startup automatically, copy a link to Id_alghw.exe to the Startup folder of your computer.

Creating a Bosch Allegiant configuration file

1. Using the Allegiant Master Control Software, create a Allegiant configuration file that specifies the computer attached to the Allegiant matrix. For this task, the Master Control dongle is required.
2. On the Transfer menu, click Communication Setup. In the Current Host list, enter the DNS name of the computer connected to the Allegiant matrix, and enter the serial port parameters (COM port number, baud rate, etc.) of the Allegiant-connected serial port. This allows the Master Control Software on the Management Server or PC to go on-line with the Allegiant system. If this is not successful, ensure that either the Master Control Software or the Allegiant Network Host program is running on the computer attached to the Allegiant matrix, and that the network security is configured to allow remote access to this computer.
3. On the Transfer menu, click Upload. Select all tables and click Upload. To save the configuration file, select a directory.
4. Exit the Master Control Software.

Adding the Bosch Allegiant matrix to BVMS

1. Start the BVMS Management Server service, start the Configuration Client, and add the Allegiant device by adding this configuration file (see Adding a device for the step-by-step instruction).
2. Ensure that the Allegiant Master Control Software configuration file used in BVMS matches the current Allegiant configuration.
BVMS runs the required components of Master Control Software invisibly in the background.

Configuring the user name for logging on the Allegiant services

If the Allegiant matrix is connected to a PC in the network and not to the Management Server, ensure that the Allegiant services on this PC and on the Management Server log on with the same user account. This user must be member of an administrators group.

Further notes in the documentation

Follow these references to get detailed information on the available windows:

- *Matrix Switches page, page 131*

Follow these references to get detailed information on the available step-by-step instructions:

- *Configuring a Bosch Allegiant device, page 132*

Refer to

- *Matrix Switches page, page 131*

5.4.3**Bosch Allegiant Satellite System Concept**

The Allegiant matrix switch allows multiple Allegiant systems to be tied together using the Satellite concept. In this case, multiple Allegiant systems can appear to the BVMS as one large system, providing access to all cameras on all systems.

In an Allegiant Satellite System, monitor outputs of a slave Allegiant are tied to video inputs on the master Allegiant. This connection is called a trunk line. In addition, a control channel is established between the master and the slave. When a camera from a slave Allegiant is requested from the master Allegiant, a command is sent to the slave instructing it to switch the requested camera to a trunk line. At the same time, the master Allegiant switches the trunk input to the requested master Allegiant monitor output. This completes the video connection from the requested slave camera to the desired master monitor.

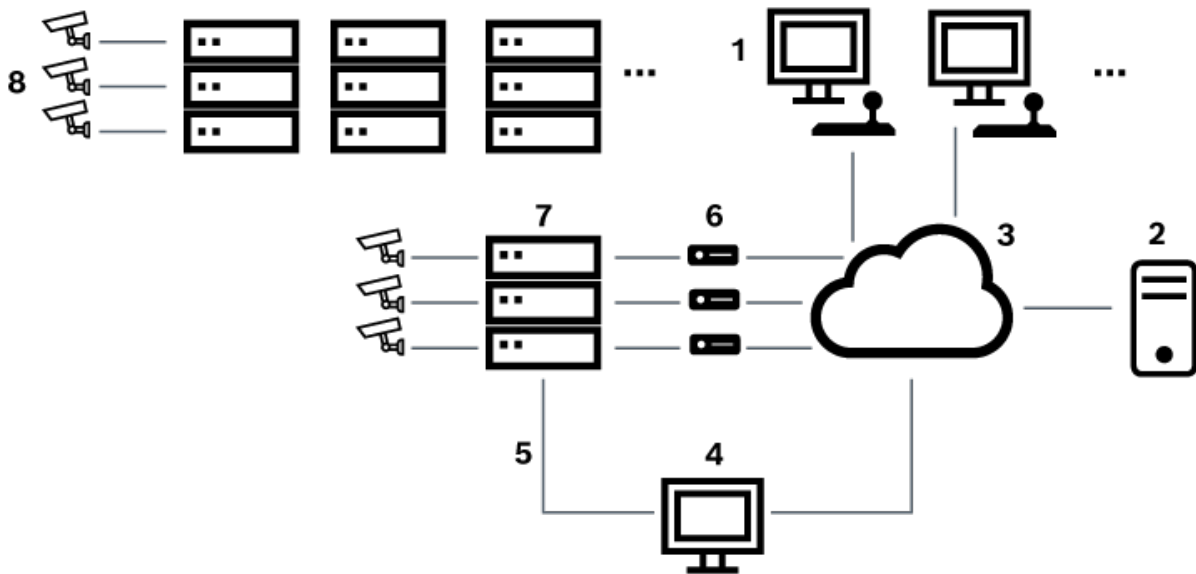

Figure 5.5: Bosch Allegiant system extended with Satellite switches

1	BVMS Client workstations
2	Management Server with Master Control Software
3	Network
4	Allegiant PC with Master Control Software
5	RS-232 connection
6	encoders
7	Allegiant matrix
8	Allegiant Satellite matrix

You can apply the Satellite concept such that an Allegiant can be both a master and a slave. In this way, each Allegiant can view cameras from the others. It is only necessary to connect trunk lines and control lines in both directions, and to properly configure the Allegiant tables. The concept can be further extended, with no practical limit, to multiple Allegiant systems. An Allegiant can have many slaves, and it can be a slave to many masters. You can program the Allegiant tables to allow or disallow user access to camera views as required by site policies.

5.5 Allegiant CCL commands supported in BVMS

To use the CCL commands you need the CCL User Guide. This manual is available in the Online Product Catalog in the document section of each LTC Allegiant Matrix.

Supported command	Description	Remarks
Switching/Sequence		
LCM	Switch Logical Camera to Monitor	LCM, LCM+ and LCM- are equivalent.
LCMP	Switch Logical Camera to Monitor with Pre-position Call	
MON+CAM	Switch Physical Camera to Monitor	
MON-RUN	Run Sequence by Monitor Number	
MON-HOLD	Hold Sequence by Monitor Number	
SEQ-REQ	Sequence Request	
SEQ-ULD	Sequence Unload	
Receiver/Driver		
R/D	Basic Control commands	
REMOTE-ACTION	Simultaneous Pan/Tilt/Zoom Control commands	
REMOTE-TGL	Toggle Pan/Tilt/Zoom Control commands	
PREPOS-SET	Set Pre-position	
PREPOS	Call Pre-position	
AUX-ON AUX-OFF	Auxiliary Control commands – Auxiliary On – Auxiliary Off	
VARSPPEED_PTZ	Variable Speed Control commands	
Alarm		Used to control virtual inputs. For example "+alarm 1" closes virtual input 1, "-alarm 1" opens virtual input 1
+ALARM	Activate an alarm	Opens a virtual input in BVMS.
-ALARM	Deactivate an alarm	Closes a virtual input in BVMS.
System		

Supported command	Description	Remarks
Switching/Sequence		
TC8x00>HEX	Set Hexadecimal Mode	
TC8x00>DECIMAL	Set Decimal Mode	

6 Use latest software

Before operating the device for the first time, make sure that you install the latest applicable release of your software version. For consistent functionality, compatibility, performance, and security, regularly update the software throughout the operational life of the device. Follow the instructions in the product documentation regarding software updates.

We only create new updates for software versions in general or limited availability state. For more information, refer to:

[Bosch Building Technologies Software Service and Support](#).

The following links provide more information:

- General information: <https://www.boschsecurity.com/xc/en/support/product-security/>
- Security advisories, that is a list of identified vulnerabilities and proposed solutions: <https://www.boschsecurity.com/xc/en/support/product-security/security-advisories.html>

Bosch assumes no liability whatsoever for any damage caused by operating its products with outdated software components.

7 Getting started

This chapter provides information on how to get started with BVMS.

7.1 Installing the software modules

**Notice!**

Install every software module on the computer that is supposed to be used for this module.

To install:

Close Configuration Client before you start the BVMS Setup.

1. Start Setup.exe or start the BVMS Setup on the Welcome screen.
2. In the next dialog box, select the modules to be installed on this computer.
3. Follow the instructions on the screen.

7.2 Using Config Wizard

Intended use for Config Wizard is the quick and easy configuration of a smaller system. Config Wizard helps you to achieve a configured system including VRM, iSCSI system, Mobile Video Service, cameras, recording profiles and user groups.

You must add iSCSI systems manually on a standard software installation.

User groups and their permissions are configured automatically. You can add or remove users and set passwords.

Config Wizard can access Management Server only on the local computer.

You can save an activated configuration for backup purposes and import this configuration later. You can change this imported configuration after import.

Config Wizard adds the local VRM automatically both on a standard software installation and on DIVAR IP 3000 and DIVAR IP 7000.

On a DIVAR IP 3000 and on a DIVAR IP 7000 the local iSCSI device is also added automatically if not already available.

On a DIVAR IP 3000 and on a DIVAR IP 7000, a local Mobile Video Service is added automatically if not already available.

**Notice!**

If you want to use decoders in your system, make sure that all encoders use the same password for the user authorization level.

To start Config Wizard:

- ▶ Click **Start** > **All Programs** > BVMS > Config Wizard
The Welcome page is displayed.

Welcome page

1 Welcome **2** Basic **3** Scan **4** Authentication **5** Cameras **6** Recording **7** Storage **8** Users **9** Finish

Welcome

Config Wizard helps you set up your BVMS quickly.

The following prerequisites must be fulfilled:

- The cameras and other network devices must have invariable IP addresses (either by using fixed IP addresses or by using static DHCP assignment).
- For cameras and other network devices to be added you must know whether they are connected to the local subnet or to other subnets.
- You need the IP addresses of storage devices that you want to add.

Config Wizard has been initialized successfully. License is valid.
Further steps can be performed.

Next

Restrictions of Config Wizard

- Config Wizard is intended for configuring a VMS where Management Server and VRM run on the same computer.
- If licenses are missing, Config Wizard allows you to save the new configuration.
- Config Wizard can only detect the following device types in the network: video encoder, video decoder and DVR.
- Storage to be added must be ready for recording. This means the device must have at least one formatted LUN. Use Configuration Client for configuring storage devices and formatting their LUNs.
- Config Wizard does not support adding Bosch DSA E-Series storage devices to the configuration.

About Config Wizard

BVMS - Config Wizard 11.1
Build 11.1.0.74

All rights reserved. Patents pending. Warning: Unauthorized reproduction or distribution of this program, or any portion of it, may result in severe civil and criminal penalties, and will be prosecuted to the maximum extent possible under the law. Portions of BVMS use MS Windows Media Technologies (c) by Microsoft Corp.

[Open Source Licenses](#)

▶ Click **Next** to continue.

Basic page

Network address	Device type	Recording Profile	Recorder
172.30.11.39	AUTODOME IP starlight		Live Only
172.31.23.168	DINION IP ultra 8000 MF		Live Only
172.31.20.20	E-Series Storages		
172.30.11.237	MIC IP starlight 7000i		Live Only
Internal	Monitor group		
172.31.21.21	VIP X1600	Continuous, Alarm Recording	VRM(172.30.11.128)
172.31.21.20	VIP X1600 XFM4	(non-uniform)	VRM(172.30.11.128)
Internal	Virtual Input		
172.30.11.128	VRM		
172.31.20.22	VRM Storage		

This page displays the latest saved configuration. You can import a BVMS file as a change to the existing configuration. This change is saved but not activated when you click **Next**. You can select the network adapter of your computer that is connected to the video devices (IP cameras, encoders, decoders, iSCSI storage systems) of your system. The IP address of this network adapter is used as IP address of the VRM, the VSG and the local iSCSI storage system.

Click **Port Mapping** to specify the public IP address or DNS name if the system shall be accessed via Internet.

Scan page

1 Welcome 2 Basic 3 Scan 4 Authentication 5 Cameras 6 Recording 7 Storage 8 Users 9 Finish

Select video devices to be added

Selected 185 of 193

✓	Device name	IP address	MAC address	Device type
<input type="checkbox"/>	DINION IP ultra 8000 MP	172.31.22.240	00-07-5f-95-81-e7	DINION IP ultra 8000 MP
<input type="checkbox"/>	FD IP micro 5000 (172.31	172.31.22.217	00-07-5f-84-24-e6	FLEXIDOME IP micro 5000
<input checked="" type="checkbox"/>	Flexidome IP Dynamic 700	172.31.22.144	00-07-5f-7a-c2-b6	FLEXIDOME IP dynamic 700
<input checked="" type="checkbox"/>	FlexiDome panorama 5000	172.31.22.62	00-07-5f-88-74-dd	FLEXIDOME IP panoramic 5000
<input checked="" type="checkbox"/>	172.30.11.198	172.31.23.202	00-07-5f-c6-71-64	FLEXIDOME multi 7000i
<input type="checkbox"/>	Camera 4	172.31.23.161	00-07-5f-99-2a-4e	DINION IP starlight 7000 HD
<input type="checkbox"/>	Camera 3	172.31.23.160	00-07-5f-99-2f-9f	DINION IP starlight 7000 HD
<input checked="" type="checkbox"/>	FLEXIDOME IP starlight 600	172.31.23.147	00-07-5f-8d-21-a5	FLEXIDOME IP starlight 600
<input checked="" type="checkbox"/>	FLEXIDOME IP panoramik	172.31.23.124	00-07-5f-84-89-e6	FLEXIDOME IP panoramic 7000
<input checked="" type="checkbox"/>	FLEXIDOME IP panoramik	172.31.23.123	00-07-5f-84-8a-e1	FLEXIDOME IP panoramic 7000
<input checked="" type="checkbox"/>	FLEXIDOME IP panoramik	172.31.23.122	00-07-5f-8b-f8-c1	FLEXIDOME IP panoramic 7000
<input type="checkbox"/>	DINION IP ultra 8000 MP	172.31.23.114	00-07-5f-8d-33-bd	DINION IP ultra 8000 MP
<input checked="" type="checkbox"/>	FLEXIDOME IP indoor 5000	172.31.23.113	00-07-5f-7c-64-32	FLEXIDOME IP indoor 5000
<input type="checkbox"/>	DINION IP ultra 8000 MP	172.31.23.102	00-07-5f-98-28-4c	DINION IP ultra 8000 MP
<input type="checkbox"/>	Dinion IP 5000i IR	172.31.23.95	00-07-5f-93-cf-bb	DINION IP 5000i IR
<input type="checkbox"/>	Dinion IP Starlight 6000 HD	172.31.23.145	00-07-5f-8d-21-d3	DINION IP starlight 6000 HD

Scan options

Range of network scan:

Local subnet only (recommended)

Across subnets

Rescan network

Change network addresses

Change the IP addresses of the selected encoders/decoders. Start with the following IP address:

..... Change IP Addresses

Next

Note:

The scan for devices can take a time. You can cancel the scan. All devices that were already scanned, are displayed in the table.

This page displays all video devices that are not included in the latest saved configuration. Clear the check boxes for the devices that should not be added to the configuration, then click

Next.

If the selected devices are not located in the same IP range as the DIVAR IP system, the device IP address can be changed by specifying a start address for the device IP range.

Authentication page

Enter passwords for devices

Device name	IP address	User name	Password	Status
172.31.23.150	172.31.23.150	service	<input type="password"/>	
Decoder (172.31.21.204)	172.31.21.204	service	<input type="password"/>	
NDC-284-P (172.31.23.15)	172.31.23.15	service	<input type="password"/>	
VIP10 (172.31.23.24)	172.31.23.24	service	<input type="password"/>	
VIPX-1600XFMD (172.31.22.4)	172.31.22.4	service	<input type="password"/>	
VIPX-1600XFMD (172.31.22.5)	172.31.22.5	service	<input type="password"/>	

You must authenticate at the devices of your system. To authenticate, enter the password for the user account of each device. An open green lock indicates a successful authentication. Devices with a status indicated by a yellow warning sign require an initial password; they do not allow logon with an empty password.

You can only click 'Next' to continue, when all locks are green.

To copy a password for authentication select a row with a shown password and press Ctrl + C. Then select the rows of the devices for which the copied password should be used. To paste the password press Ctrl + V.

This page is used to authenticate at video devices protected by password. For easy authentication with the same password for multiple devices you can use the clipboard (CTRL+C, CTRL+V):

1. Click **Show passwords**.
2. Select a row with a successfully authenticated device (green lock is displayed), press CTRL+C, select multiple rows displaying a red lock and press CTRL+V).

Password check is performed automatically, when you do not enter a further character in the password field for a few seconds or you click outside the password field.

You can provide a global default password for all devices that are currently not protected by a password.

If a device requires an initial password,  is displayed.

To set an initial password:

1. Enter the password in the **Password** field.
2. Click **Set Initial Passwords**.

The initial password is set.

Note: As long as you have not set the initial password for all devices in the list that require an initial password, you cannot continue.

3. Click **Next** to continue.

Cameras page

Specify camera settings

Camera name	IP address	Recording quality	Live quality
Camera 1 (172.31.22.227)	172.31.22.227	Bit Rate Optimized	Balanced
Camera 1 (172.31.22.229)	172.31.22.229	Bit Rate Optimized	Balanced

Next

You can rename each camera in the 'Camera name' column.

You can configure recording quality and live quality for each camera. Fractional frame rates (FR) are indicated by the profile names and refer to the fraction of the maximum frame rate of the corresponding camera model.

You can change the settings of the 'Recording quality' and the 'Live quality' columns of multiple cameras simultaneously. To that end select those cameras and change the settings in one of the selected cameras.

If the settings in a column are not identical for all selected cameras, you can click '<no change>' to avoid changing these settings unintentionally.

You can sort cameras in folders. These folders must be created in Configuration Client.

In the Preview pane, you can see a still image of the selected camera.

Preview

Use this page to manage the cameras of your system.

Recording page

Specify recording settings

Selected 0 of 2

Device name	IP address	Recording profile	Storage Min Time (days)	Storage Max Time (days)
VIP X1 (172.31.22.227)	172.31.22.227	Continuous, Alarm Re	1	unlimited
NBC-255-P (172.31.22.229)	172.31.22.229	Continuous, Alarm Re	1	unlimited

Alarm Recording
 Alarm Recording Night and Weekend
 Continuous Only
 Continuous Only Night and Weekend
 Continuous, Alarm Recording
 No Recording

You can specify the recording profile and how long you want to store the recordings.

You can change the settings for several cameras in parallel. To that end select those cameras and change the settings in one of the selected cameras. If the settings in a column are not identical for all selected cameras, you can click '<no change>' to avoid changing these settings unintentionally.

Cameras recorded by DVR devices are not shown, because the recording settings for these cameras can only be set using the configuration application of the DVR device.

Motion Alarm Recording in Recording Profiles

Recording profile	Motion Triggered Alarm Recording
Alarm Recording	<input type="checkbox"/>
Alarm Recording Night and Weekend	<input type="checkbox"/>
Continuous Only	<input type="checkbox"/>
Continuous Only Night and Weekend	<input type="checkbox"/>
Continuous, Alarm Recording	<input checked="" type="checkbox"/>
No Recording	<input type="checkbox"/>

Next

Only those cameras are displayed on this page which were newly added. As soon as you activate this configuration, you cannot change the profile assignment of these cameras. You can enable motion recording for the recording profiles with both recording and alarm recording enabled. If required, configure recording and alarm recording in Configuration Client (**Scheduled Recording Settings** dialog box).

VCA is activated automatically for each newly added camera.

Storage page

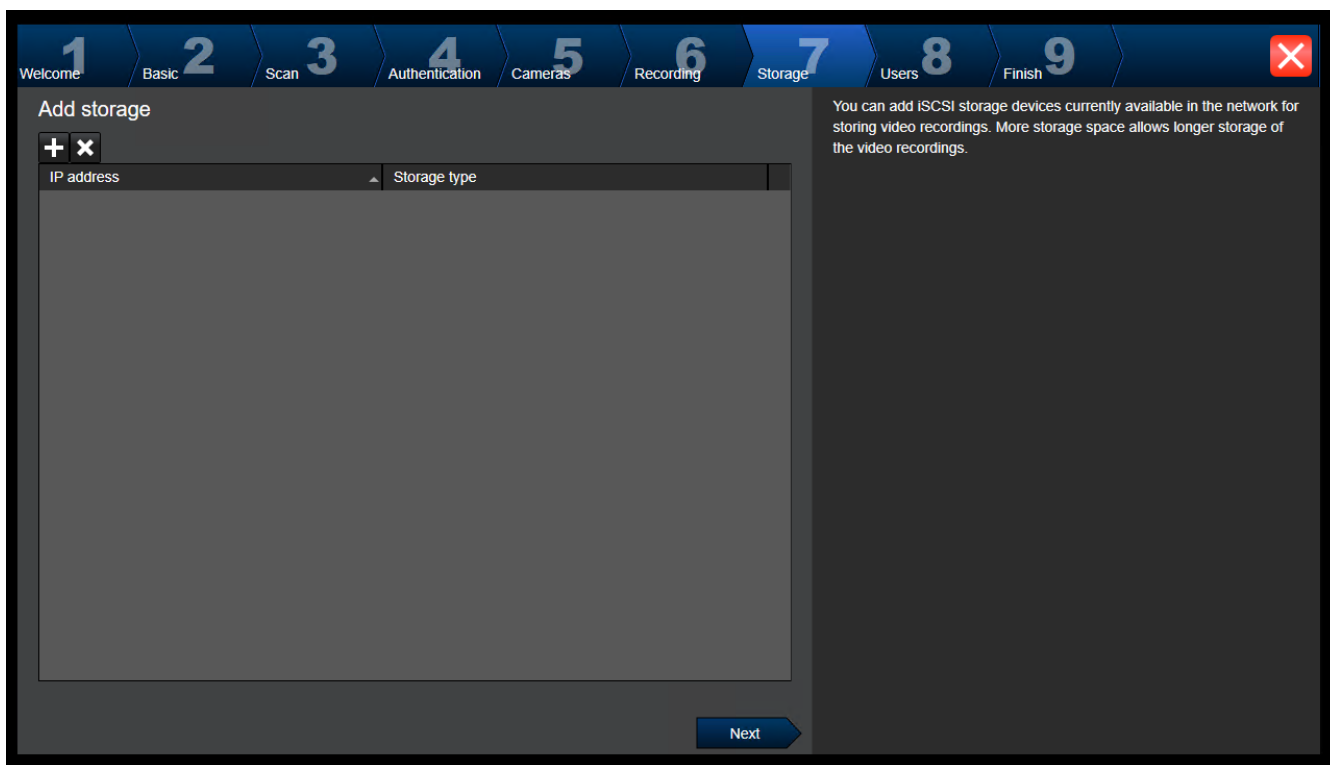

This page allows the addition of further iSCSI storage devices

Users page

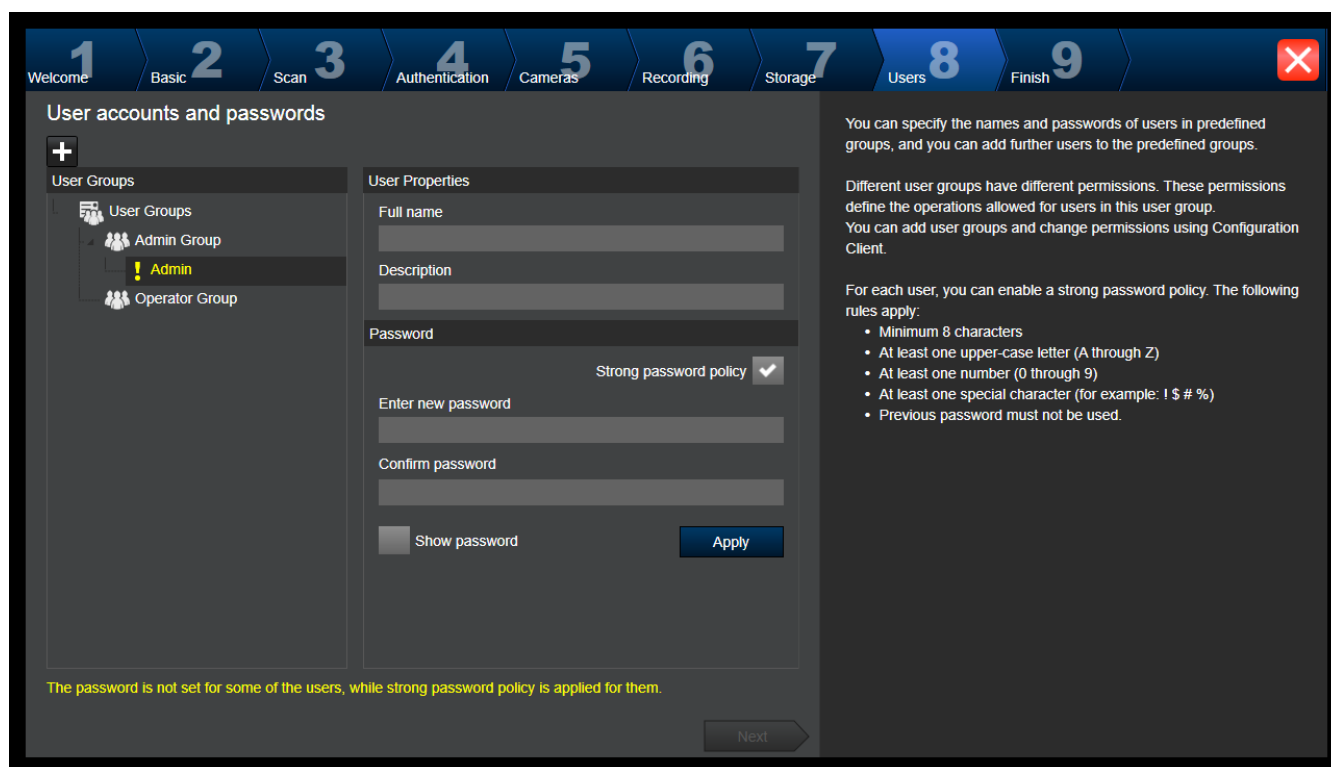

On this page you can add new users to the existing user groups.

- ▶ For every new user enter user name and description and set a password.

Strong password policy

The **Strong password policy** check box is pre-selected for all newly created user groups.

We highly recommend to keep this setting to enhance the protection of your computer against unauthorized access.

The following rules apply:

- Minimum password length as set on the **Account policies** page for the appropriate user group.
- Do not use one of the previous passwords.
- Use at least one upper-case letter (A through Z).
- Use at least one number (0 through 9).
- Use at least one special character (for instance: ! \$ # %).
- ▶ Click **Apply** to apply the settings, then click **Next** to continue.

Note: As long as there are users for whom no passwords have been set although the **Strong password policy** was enabled, you cannot continue. To continue, set the missing passwords.

Use Configuration Client to add user groups and to change user group permissions.

Finish page

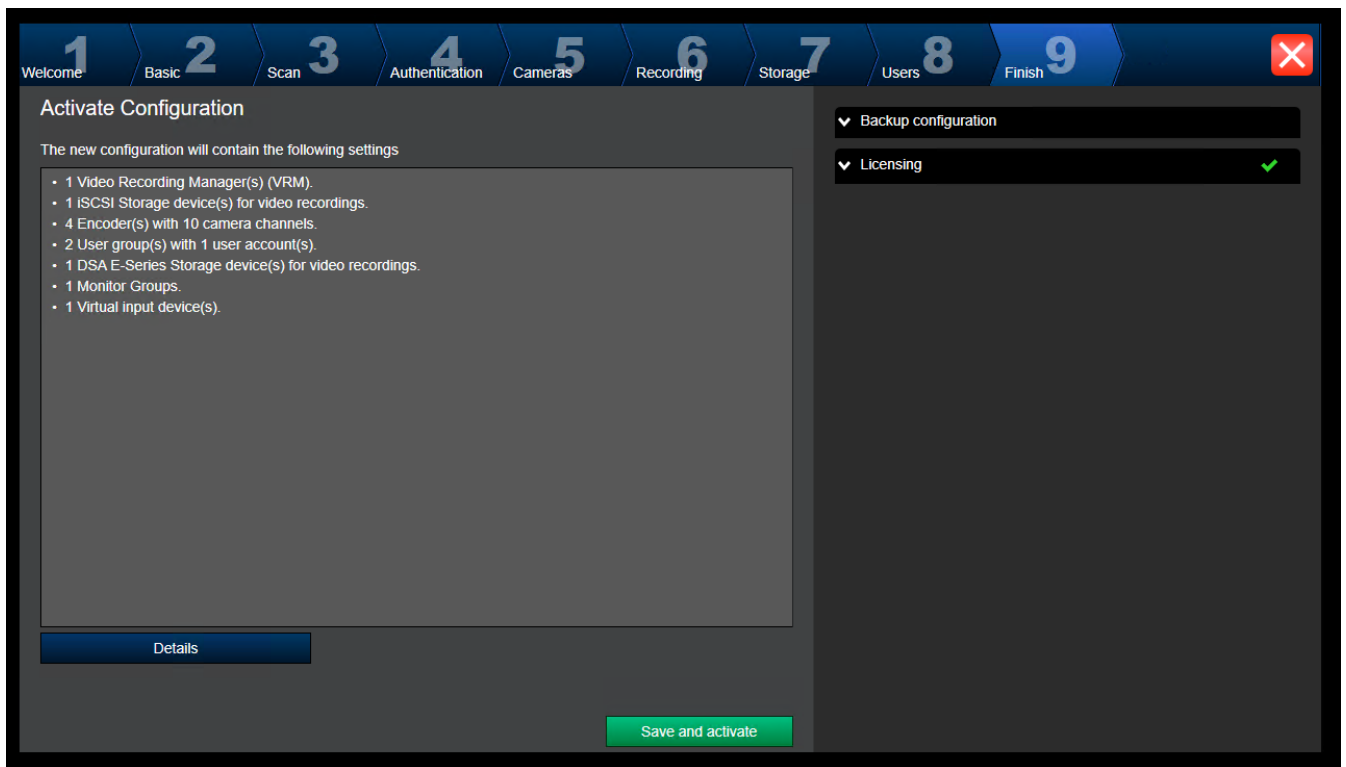

Before you can activate your configuration you must perform the following tasks:

- Provide a global default password for all devices that are not currently protected by a password.
- Activate your license package if required.

Global default password

If in Configuration Client the option **Enforce password protection on activation (Settings -> Options)** is disabled, you are not forced to provide a global default password to activate.

Licensing

Expand **Licensing** and click **License Wizard** to check or activate your license package.

After clicking **Save and activate**, the configuration is activated.

After successful activation, the **Finish** page is displayed again. Now you can store a backup of the configuration if desired: Click **Save backup copy**.

After clicking **Save and activate**, the configuration is activated.

After successful activation, the **Finish** page is displayed again. Now you can store a backup of the configuration if desired: Click **Save backup copy**.

7.3 Starting Configuration Client



Notice!

Only admin users can log on to Configuration Client.

The preconfigured default admin user is the user called Admin. Only this user can log on to Configuration Client when you start Configuration Client for the first time.

Once you have started Configuration Client, you can rename the Admin user and change the password.

Note:

You cannot start Configuration Client when another user on another computer in the system has already started Configuration Client.

To start Configuration Client:

1. From the **Start** menu, select **Programs** > BVMS > Configuration Client.
The dialog box for logging on is displayed.
2. In the **User Name:** field, type your user name.
When you start the application for the first time, enter Admin as user name, no password required.
3. In the **Password:** field, type your password.
4. Click **OK**.
The application starts.

When the Admin user starts Configuration Client for the first time, the **Password policy is violated** dialog box is displayed asking him to set a password for the Admin user account. We highly recommend to keep this setting and to set a strong password for the Admin user account according to the password policy rules.

Refer to

- *Strong password policy*, page 332
- *Configuring Admin Group*, page 337

7.4

Configuring the language of Configuration Client

You configure the language of your Configuration Client independently of the language of your Windows installation.

To configure the language:



1. On the **Settings** menu, click **Options....**
The **Options** dialog box is displayed.
2. In the **Language** list, select the desired language.
If you select the **System language** entry, the language of your Windows installation is used.
3. Click **OK**.
The language is switched after the next restart of the application.

7.5

Configuring the language of Operator Client

You configure the language of your Operator Client independently of the language of your Windows installation and of your Configuration Client. This step is performed in the Configuration Client.

To configure the language:

1. Click **User groups** > . Click the **User group properties** tab. Click the **Operating permissions** tab.
2. In the **Language** list, select the desired language.
3. Click  to save the settings.
4. Click  to activate the configuration.
Restart Operator Client.

7.6 Scanning for devices

Main window > **Devices**

You can scan for the following devices to add them with the help of the **BVMS Scan Wizard** dialog box:

- VRM devices
- Encoders
- Live only encoders
- Live only ONVIF encoders
- Local storage encoders
- Decoders
- Video Streaming Gateway (VSG) devices
- DVR devices

If you want to add devices via scan, see the respective device topic in the chapter *Devices* page, page 122.

Refer to

- *Adding VRM Devices via scan, page 166*
- *Adding an live only ONVIF device via scan, page 225*
- *Adding live only devices via scan, page 203*
- *Adding a device, page 123*

7.7 Accessing the system

You access a system performing the following steps:

1. Perform one of the following steps to select the network address of the desired system:
 - Click a preselected list entry.
 - Enter a network address manually.
 - Select a network address using Server Lookup.
2. Log on to the desired system:
 - Single server system
 - Enterprise System

7.8 Using Server Lookup

- The BVMS Server Lookup feature allows Operators to connect to a BVMS Management Server out of a provided list of servers.
- A single user of Configuration Client or Operator Client can connect to multiple system access points sequentially.
- System access points can be Management Server or Enterprise Management Server.
- Server Lookup uses dedicated Management Server to host the Server List.
- Server Lookup and Management Server or Enterprise Management Server functionally can be run on one machine.
- Server Lookup supports you in locating system access points by their names or descriptions.
- Once connected to the Management Server the Operator Client receives events and alarms from the BVMS Management Server and shows live and playback

To access:

1. Start Operator Client or Configuration Client.
The logon dialog box is displayed.

2. In the **Connection:** list, select **<Address Book...>** for Configuration Client or **<Address Book...>** for Operator Client.
If private and public IP address has been configured for a server, this is indicated.
If you select **<Address Book...>** or **<Address Book...>** for the first time, the **Server lookup** dialog box is displayed.
3. In the **(Enterprise) Management Server address** field, type in a valid network address of the desired server.
4. Enter a valid user name and password.
5. If required, click **Remember settings**.
6. Click **OK**.
The **Server lookup** dialog box is displayed.
7. Select the desired server.
8. Click **OK**.
9. If the selected server has both a private and a public network address, a message box is displayed asking whether you are using a computer located in the private network of the selected server.
The server name is added to the **Connection:** list in the logon dialog box.
10. Select this server in the **Connection:** list and click **OK**.
If you have selected the **Remember settings** check box, you can select this server directly when you again want to access this server.

7.9 Activating the software licenses

When you install BVMS for the first time, you must activate the licenses for the software packages that you have ordered, including the base package and any expansions and/or optional features.

To activate the system:

1. Start BVMS Configuration Client.
2. On the **Tools** menu, click **License Manager....**
The **License Manager** dialog box is displayed.
3. Click **Add** to add your licenses.
The **Add license** dialog box is displayed.
4. Follow the instructions in the dialog.
5. After successful activation, close the **Add license** dialog box.
6. Close the **License Manager** dialog box.

For further information refer to the respective BVMS licensing whitepaper.

Refer to

- *License Inspector dialog box (Tools menu), page 78*
- *License Manager dialog box (Tools menu), page 76*
- *Add license dialog box, page 78*
- *BVMS License activation overview, page 18*

7.9.1 License Manager dialog box (Tools menu)

Main window > **Tools** menu > **License Manager...** command

Allows you to license the BVMS package that you have ordered and to upgrade with additional features.

License status

Displays the licensing status.

System fingerprint

For support purposes we recommend to provide the **System fingerprint**.

Installation site

When activating your base license in the Bosch Remote Portal, you provide information about the installation site of your system. This information displays here.

Note: You can also provide this information in other licenses, but only the information provided in the base license displays here.

Licenses

1. Click **Add** to add your licenses.
The **Add license** dialog box is displayed.
2. Follow the instructions in the dialog.

Effective license

Displays the effective base license that you have activated.

Features

- ▶ Click **License Inspector...**

The **License inspector** dialog box displays.

Displays the quantity of the licensed features that are currently installed.

You can check whether the number of installed BVMS licenses exceeds the number of purchased licenses.

Installed BVMS version

Displays the currently installed BVMS version, for example 11.0.

Licensed BVMS versions

Displays all BVMS versions that are included and supported in the current provided license file.

For example: BVMS 11.0 and all upcoming minor versions BVMS 11.x.

Activation date

Displays the activation date of your installed BVMS version.

Expiration date

Displays the expiration date of your installed BVMS version. An Expiration date is only applicable when you install an emergency license or a sales demo license.

Software Maintenance Agreement

Expiration date

If you have purchased and activated any Software Maintenance Agreement, the expiration date displays here.

Refer to

- *Activating the software licenses, page 76*
- *Add license dialog box, page 77*
- *License Inspector dialog box (Tools menu), page 78*

7.9.1.1

Add license dialog box

Main window > **Tools** menu > **License Manager...** command > **Licenses** > **Add**

Allows you to add your purchased licenses or demo licenses from the Bosch Remote Portal website remote.boschsecurity.com to your BVMS system.

To add your licenses follow the instructions in the dialog.

For further information refer to the respective BVMS licensing whitepaper.

7.9.2 Add license dialog box

Main window > **Tools** menu > **License Manager...** command > **Licenses** > **Add**

Allows you to add your purchased licenses or demo licenses from the Bosch Remote Portal website remote.boschsecurity.com to your BVMS system.

To add your licenses follow the instructions in the dialog.

For further information refer to the respective BVMS licensing whitepaper.

7.9.3 License Inspector dialog box (Tools menu)

Main window > **Tools** menu > **License Inspector...** command > **License inspector** dialog box

Displays the quantity of the licensed features that are currently installed.

You can check whether the number of installed BVMS licenses exceeds the number of purchased licenses.

Note: If the current system configuration exceeds the limits of the currently installed licenses, you can not activate the configuration.

7.10 Maintaining BVMS

This chapter provides information on how to maintain a just installed or upgraded BVMS.

Perform the following tasks for maintaining the system:

- Export BVMS configuration and user settings. The version history (all versions of the configuration that were activated earlier) is not exported. It is recommended to activate your configuration before exporting.
 - See *To export configuration data*, page 78 for the procedure.

Or

- Perform a backup of the elements.bvms. This is required if you want to restore an (Enterprise) Management Server including the version history. User settings are not included.
 - See *To perform a backup*, page 78 for the procedure.
- Save VRM configuration file (config.xml)
 - See *To save VRM configuration*, page 79 for the procedure.

This exported configuration does not keep the system's history. No rollback is possible.

The entire system configuration including the complete history of system changes is stored in one file:

C:\ProgramData\Bosch\VMS\Elements.bvms.

To export configuration data:

1. On the **System** menu, click **Export Configuration....**
The **Export Configuration File** dialog box is displayed.

Note: If your current working copy configuration is not activated ( is active), you export this working copy and not the activated configuration.

2. Click **Save**.
3. Enter a filename.
The current configuration is exported. A .zip file with database and user data is created.

To perform a backup:

1. Stop the service BVMS **Central Server** on the (Enterprise) Management Server.
2. Copy the file elements.bvms to the desired directory for backup.
3. Start the service BVMS **Central Server** on the (Enterprise) Management Server.

The VRM configuration is stored in a single encrypted file config.xml.

The file can be copied and stored for backup while the VRM service is up and running.

The file is encrypted and contains all VRM relevant data such as:

- User data
- All system devices and their VRM relevant settings

Parts of the VRM configuration are also stored in the BVMS configuration. When you change something within these data, it is written to config.xml after activating the BVMS configuration.

The following settings are not stored in the BVMS configuration:

- **VRM Settings > Main Settings**
- **Network > SNMP**
- **Service > Advanced**
- **Recording preferences**
- **Load Balancing**

When you change something on one of these pages, it is written immediately to the VRM Server and not saved in the BVMS configuration.

To save VRM configuration:

- ▶ Copy Config.xml to safe location.
You can find this file in the following directory for a Primary VRM:
C:\ProgramData\Bosch\VRM\primary
You can find this file in the following directory for a Secondary VRM:
C:\ProgramData\Bosch\VRM\secondary

7.11 Replacing a device

This chapter provides information on how to repair the system for example when devices fail and must be replaced.

Prerequisite

The maintenance tasks have been performed.

Refer to

- *Maintaining BVMS, page 78*

7.11.1 Replacing a MS / EMS

There is no difference between Management Server and Enterprise Management Server replacement.

You can either restore the configuration of the old Management Server or Enterprise Management Server or you can import the exported configuration.

When you restore the configuration, the Server ID remains unchanged.

When you import the configuration, the Server ID of the new system is used. You need a new Server ID if you want to create an Enterprise System using an exported configuration that you import in each Management Server as a template. Each Management Server in this Enterprise System must have a unique Server ID.

You can import an exported configuration and the user settings of this configuration. The user settings contain the users that were added in this configuration and their settings in Operator Client like window sizes and favorites.

Note: Importing a configuration does not restore the version history of the old configuration. When you import a configuration, no user settings are imported. You must manually restore the exported user settings.

To import the configuration:

1. On the **System** menu, click **Import Configuration...**
The **Import Configuration File** dialog box is displayed.

2. Select the desired file for import and click **Open**.
The **Import Configuration...** dialog box is displayed.
3. Enter the appropriate password and click **OK**.
The Configuration Client is restarted. You must logon again.
The imported configuration is not activated but editable in Configuration Client.

To restore the exported configuration:

You can only access (copy, delete) this file when the BVMS **Central Server** service is stopped.

1. Stop the service BVMS **Central Server** on the (Enterprise) Management Server.
2. If required, rename the backup file to Elements.bvms.
3. Replace the existing Elements.bvms.
4. Start the service BVMS **Central Server** on the (Enterprise) Management Server.

Note: To reset the system to an empty configuration, stop the service and delete the Elements.bvms.

Further configuration files:

- Elements.bvms.bak (from V.2.2 on): Automatic backup file of the last activation including version history. Later changes of the configuration being not activated, are not included.
- Elements_Backup*****.bvms: Configuration from an older version. This file is created after a software update.

To restore the exported user settings:

1. Extract the zip file that was created during the maintenance export.
The `export.bvms` file and the `UserData` directory are extracted.
2. On the desired (Enterprise) Management Server: Copy the `UserData` directory to `C:\ProgramData\Bosch\VMS\`.

7.11.2

















Replacing a VRM

Prerequisites

- Installed OS with correct network settings and the correct version of VRM.

To replace the VRM device from within BVMS:

1. Start BVMS Configuration Client.
2. In the Device Tree, select the VRM device.
3. Perform the settings on the following pages, then save and activate the configuration:

- Main window > **Devices** > Expand  > Expand  > 
- Main window > **Devices** > Expand  > Expand  > **VRM Settings** > **Main Settings**
- Main window > **Devices** > Expand  > Expand  > **Network** > **SNMP**
- Main window > **Devices** > Expand  > Expand  > **Service** > **Advanced**
- Main window > **Devices** > Expand  > Expand  >  >  > **Advanced Settings** > **Recording Preferences**
- Main window > **Devices** > Expand  > Expand  >  >  > **iSCSI** > **Load Balancing**

To replace the VRM device without BVMS:

You use the original backup `config.xml` from the VRM device, containing all configuration settings (no further settings are required).

1. Stop the **Video Recording Manager** service.

2. Copy config.xml to the new server.
3. Start the **Video Recording Manager** service.

To replace an iSCSI device (planned failover):

1. Add the new iSCSI device.
2. Using Configuration Manager, on the iSCSI device to be replaced, configure all LUNs as read-only.

Note: You can remove the old iSCSI device when the old recordings are no longer required.



Notice!

When you configure the new iSCSI device, we recommend to use the same CHAP password as for the old device.

If you use a new CHAP password, make sure to set this new password as a system-wide CHAP password and to assign it to all iSCSI devices.

Otherwise you will not be able to authenticate at the iSCSI and to show direct playback from the iSCSI device.

7.11.3

Replacing an encoder or decoder



Notice!

Do not remove a device from the Device Tree if you want to retain its recordings. For replacing this device, exchange the hardware.

Replacing an encoder/decoder of the same type

Prerequisite is a factory default device (IP Address = 192.168.0.1).

1. Disconnect the old device from the network.
2. Do not delete the device from the Device Tree in the BVMS Configuration Client! When deleting the device from VRM, recording is lost.
3. Connect the new device of the same type to the network.



Notice!

The next steps require the above mentioned default IP address. With DHCP assigned IP addresses you cannot perform the initial device scan.

4. Configuration Client: On the **Hardware** menu, click **Initial Device Scan...**
The **Initial Device Scan** dialog box is displayed.
5. Click a cell to change the desired address. For changing multiple devices, select the desired rows. You can select multiple devices by pressing the CTRL- or the SHIFT-key. Then right-click the selected rows and click **Set IP Addresses...** or click **Set Subnet Mask...** to change the corresponding values.
You must enter the correct subnet mask and IP address.
Subnet mask and IP Address must be identical to the replaced device.
6. Click **OK**.
7. After a few seconds you can access the device setting in the Device Tree.
8. Change all required device settings that are not controlled by BVMS (refer to information below).
9. Save and activate.

Notes:

- The initial device scan only finds devices with default IP addresses (192.168.0.1) or duplicate IP addresses.

- Do not use the VRM scan to scan defaulted devices since you will not be able to change the IP address afterwards.





Replacing an encoder with DHCP assigned IP address:

Prerequisite is a factory default encoder (DHCP assigned IP).

1. Connect the encoder to the Ethernet port of your computer directly.
2. Write down the network adapter configuration for TCP/IPv4 to restore it later.
3. On the network adapter of your computer, configure the following fixed IP address and subnet mask for your network adapter:
192.168.0.2
255.255.255.0
4. Start Internet Explorer.
5. In the **Address** bar, type in 192.168.0.1.
The Web page of the device is displayed.
6. Click **Settings**, then click **Network**.
7. On the **Network** page, in the **DHCP** list, select **Off**.
8. In the **IP address** field, in the **Subnet mask** field and in the **Gateway address** field, type in the required values valid for your network.
9. Click **Set and Reboot**.
10. Restore the network adapter configuration.

Replacing an encoder/decoder of another device type

- Disconnect the old device from the network.
- Do not delete the device from the Device Tree in the BVMS Configuration Client!
- Connect the new device of the new type to the network.

Main window > **Devices** > Expand  > Expand  > Expand  > Right-click  > Click **Edit Encoder** > **Edit Encoder** dialog box
or

Main window > **Devices** > Expand  > Right-click  > Click **Edit Encoder** > **Edit Encoder** dialog box
or

Main window > **Devices** > Expand  > Right-click  > Click **Edit Encoder** > **Edit Encoder** dialog box
or

Main window > **Devices** > Expand  > Expand  > Right-click  > Click **Edit Decoder** > **Edit Decoder** dialog box

After an upgrade of the device, you can update its device capabilities. A message text informs you whether the retrieved device capabilities match the device capabilities stored in BVMS.

To update:

1. Click **OK**.
A message box is displayed with the following text:
If you apply the device capabilities, the recording settings and the event settings for this device may change. Check these settings for this device.
2. Click **OK**.
The device capabilities are updated.

Replacing a VSG camera

When you replace a VSG camera, ensure that the replaced camera has the same type, the same IP address and the same ONVIF profile as the old camera.

Additionally you must perform the following settings on a new AXIS camera via the Web interface of the VSG camera before replacing the old AXIS camera:

- Set a password for user root
- Configure time synchronization
- Disable link-local address
- Create an ONVIF user
- Disable replay attack protection

Settings controlled by BVMS

Encoders and decoders configured in a BVMS system are controlled by the BVMS Server and thus cannot be shared with other applications.

You can use the BVMS Device Monitor to check which device show a mismatching configuration deviating from the BVMS configuration.

BVMS Configuration Client offers configuration pages for all BVIP devices.

The scale of settings depends on the particular BVIP model (e. g. VIPX 1600 XFM4).

BVMS keeps control of all BVIP settings required for a seamless integration into a BVMS system.

Settings controlled by BVMS:

- Camera name
- Time server settings
- Recording Management (profiles, retention times, schedules)
- Definitions of quality settings
- Passwords

Stored in the BVMS configuration but not changed on the devices:

- IP address (you can change IP addresses with BVMS IP Device Configuration)
- Relay / input names (difference between names in the device and names configured in BVMS is displayed)

System events for mismatching device configuration

- SystemInfo events are generated, once the configuration of a device has been fixed during a periodic check.
- SystemWarning events are generated, once a mismatching configuration has been detected on a device for the first time. Subsequent checks do not raise this event until the configuration has been corrected by an activation or a periodic fix.
- SytemError events are generated, once an error regarding configuration has been detected during activation or periodic checks. Subsequent checks do not raise this event until the configuration has been corrected by an activation or a periodic fix.

7.11.4

Replacing an Operator Client

To replace an Operator Client workstation:

1. Replace the computer.
2. Start the BVMS Setup on the new computer.
3. In the list of components to be installed, select Operator Client.
If required, select other components that were installed on the replaced computer.
4. Install the software.

7.11.5 Final tests

To check MS / EMS replacement and Operator Client replacement:

1. Activate the configuration.
2. Start Operator Client.
3. Check the Logical Tree in Operator Client.
It must be identical with Logical Tree in Configuration Client.

To check VRM replacement:

- ▶ Start VRM Monitor and check the active recordings.

7.11.6 Recovering Divar IP 3000/7000

Refer to the Installation Manuals of DIVAR IP 3000 or DIVAR IP 7000. In the chapter on recovering the unit you find how to proceed.

7.12 Configuring time synchronization







Notice!

Ensure that the time of the all computers of BVMS is synchronized with Management Server. Otherwise you can loose recordings.

Configure the time server software on Management Server. On the other computers, configure the IP address of Management Server as time server using standard Windows procedures.

7.13 Configuring the storage media of an encoder

Main window > **Devices** > Expand  > Expand  >  >  > **Advanced Settings** > **Recording Management**

Note: Ensure that the desired cameras of this encoder are added to the Logical Tree. You must configure the storage media of an encoder to use the ANR function.

Note: If you want to configure the storage media of an encoder that has already been added to your system and is recorded via VRM, ensure that secondary recording is stopped:

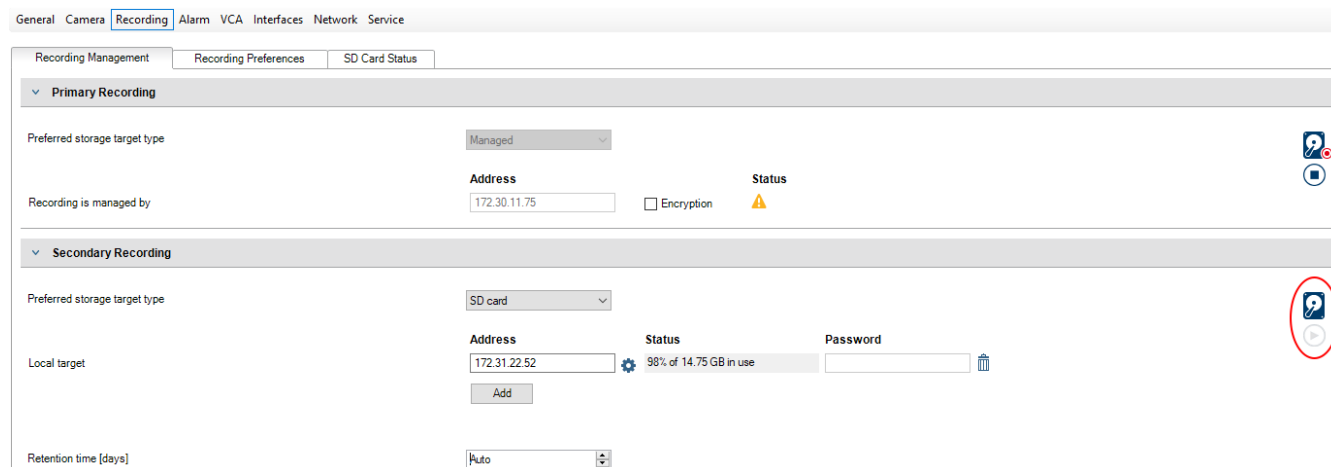

The ANR function only works on encoders with firmware version 5.90 or later. Not all encoder types support ANR even if the correct firmware version is installed.

To configure the storage media of an encoder:

1. Under **Secondary Recording**, in the **Preferred storage target type** list, select the storage media. Depending on the device type, different media are available.

2. If required, click the ... button to format the storage media.
After the successful formatting process, the storage media is ready for use with the ANR function.
3. Configure the ANR function for this encoder on the **Cameras and recording** page.

Refer to

- *Recording Management page, page 222*
- *Configuring the ANR function, page 287*

8 Creating an Enterprise System

Perform the following tasks to create an Enterprise System on an Enterprise Management Server and on multiple Management Server computers:

1. *Configuring the Server List for Enterprise System, page 86*
2. *Creating an Enterprise User Group, page 87*
3. *Creating an Enterprise Account, page 87*

You need valid licenses for using an Enterprise System.

Refer to

- *Enterprise System, page 23*

8.1 Configuring the Server List for Enterprise System

Main window > **Devices** > **Enterprise System** > **Server List / Address Book**



You configure multiple Management Server computers in the Server List of an appropriate Management Server.

For simultaneous access you must configure one or more Enterprise User Groups. This changes this Management Server to an Enterprise Management Server.

A user of Operator Client can log on with a user name of an Enterprise User Group to get simultaneous access to the Management Server computers configured in the Server List.

Operating permissions are configured on the Enterprise Management Server in **User groups**, Enterprise User Group tab.

Device permissions are configured on each Management Server in **User groups**, Enterprise Access tab.

- Click  to save the settings.
- Click  to undo the last setting.
- Click  to activate the configuration.

To add servers:

1. Click **Add Server**.
The **Add Server** dialog box is displayed.
2. Type in a display name for the server and type in the private network address (DNS name or IP address).

Note: If you use a SSH connection, enter the address in the following format:
ssh://IP or servername:5322

3. Click **OK**.
4. Repeat these steps until you have added all desired Management Server computers.

To add columns:

- ▶ Right-click on the table header and click **Add column**.
You can add up to 10 columns.
To delete a column, right-click the desired column and click **Delete column**.
 - ⇒ When you export the Server List, the added columns are also exported.
- The Management Server computers for your Enterprise System are configured.

Refer to

- *Enterprise System, page 23*

- *Server list / Address Book page, page 126*
- *User Groups page, page 311*
- *Using Server Lookup, page 75*

8.2 Creating an Enterprise User Group

Main window > **User groups**

You perform the task of creating an Enterprise User Group for an Enterprise System on the Enterprise Management Server.

You create an Enterprise User Group with users to configure their operating permissions. These operating permissions are available on an Operator Client that is connected to the Enterprise Management Server. An example of an operating permission is the user interface of the alarm monitor.

To create an Enterprise User Group:

1. Click the **Enterprise User Groups** tab.
Note: The **Enterprise User Groups** tab is only available if the appropriate license is available and if one or more Management Server computers are configured in **Devices > Enterprise System > Server List / Address Book**.
2. Click .
 The **New enterprise user group** dialog box is displayed.
3. Type in the name and a description.
4. Click **OK**.
 The Enterprise User Group is added to the corresponding tree.
5. Right-click the new Enterprise group and click **Rename**.
6. Enter the desired name and press ENTER.
7. On the **Operating permissions** page, configure the operating permissions and server access for the configured Management Server computers as required.

Refer to

- *User Group Properties page, page 313*
- *Operator Features page, page 319*
- *Priorities page, page 322*
- *User Interface page, page 322*
- *Server Access page, page 323*

8.3 Creating an Enterprise Account

Main window > **User groups**



Notice!

At least one device must be configured in the Device Tree before you can add an Enterprise Account.

You perform the task of creating an Enterprise Account on a Management Server. Repeat this task on each Management Server that is a member of your Enterprise System.

You create an Enterprise Account to configure the device permissions for an Operator Client using an Enterprise System.

To create an Enterprise Account:

1. Click the **Enterprise Access** tab.

2. Click .
The **New Enterprise Account** dialog box is displayed.
3. Type in the name and a description.
4. The **User must change password at next logon** check box is pre-selected for all newly created user accounts.
Type the key according to the key policy rules and confirm this key.
5. Click **OK**.
A new Enterprise Account is added to the corresponding tree.
6. Right-click the new Enterprise Account and click **Rename**.
7. Enter the desired name and press ENTER.
8. On the **Device permissions** page, configure the credentials and the device permissions as required.

Refer to

- *Strong password policy , page 332*
- *Credentials page, page 318*
- *Logical Tree page, page 318*
- *Events and Alarms page, page 317*
- *Control Priorities page, page 316*
- *Camera Permissions page, page 315*
- *Decoder Permissions page, page 317*

8.4 Token-based authentication

The Enterprise Account allows Enterprise management clients to access a Management Server that is configured in the server access list of the Enterprise Management Server.

The Enterprise Account is secured by a key. When you have to change this key, you also have to change it on the Management Server and on the Enterprise Management Server.

Additionally, you have to activate the changed configuration.

If you have a large number of Management Server connected to an Enterprise Management Server, this could be time consuming.

Instead of securing the Enterprise Account with a username and a key, you can configure token-based authentication.

1. The Enterprise Management Server creates the token.
2. The token is signed by using a certificate called Token Issuer.
3. The Management Server grants access when the token is valid.
The Management Server only grants access if the Management Server is configured to trust the Token Issuer certificate.

Prerequisites

For signing and validating the token you need a certificate or a chain of certificates.

Note: The certificates are not generated or installed by BVMS. You have to provide and install them independently. BVMS can use certificates installed in the Windows Certificate Store.

There are different prerequisites on Enterprise Management Server and Management Server machines. The following explains which environment requires which certificates.

Certificate

- The Enterprise Management Server requires the certificate and its private key.

- The Management Server requires the certificate.

Certificate chain

A certificate chain starts with a Root certificate which you use to sign another certificate. You can then use this certificate again to sign yet another certificate. You can define the length of the certificate chains by yourself.

- The Enterprise Management Server requires the whole certificate chain.
For the last certificate in the chain (Token Issuer), a private key is required.
- The Management Server requires only parts of the certificate chain, depending on the configured access token settings.

To configure token-based authentication, do the following steps:

1. Configuration of the Enterprise Management Server
 - Define access token authentication for the Enterprise Accounts
 - Configure the access token settings
2. Configuration of the Management Server
 - Specify the trusted certificates
 - Deny access to the Enterprise Account by key



For detailed information about the respective topics refer to the Token-based authentication White Paper.

Refer to

- *Access token settings dialog box (Settings menu), page 117*
- *Server Access page, page 323*

9 Configuring Command Scripts

This chapter describes how to configure Command Scripts. Command Scripts appear at various places of BVMS.

1. Click  to save the settings.
2. Click  to undo the last setting.
3. Click  to activate the configuration.



Notice!

Server Scripts gets activated during restart of Management Server service even if not activated from within Configuration Client.

9.1 Managing Command Scripts

Main window

You can create a Command Script using the following scripting languages:

- C#
- VB.Net

You cannot change the scripting language of an existing Command Script.

You can create a Client Script or a Server Script.

You can add scriptlets to every script.

To get help on entering code, click  in the **Command Script Editor** dialog box. The Bosch Script API help is displayed.

To add a server scriptlet:

1. On the **Tools** menu, click the **Command Script Editor...** command.
The **Select Script Language** dialog box is displayed if no Command Script was created yet.
2. In the **Script Language:** list, select the required entry.
The **Command Script Editor** dialog box is displayed.
3. In the left pane of the **Command Script Editor** dialog box, right-click ServerScript and click **New Scriptlet**.
A new scriptlet is added.
4. Enter your code.

To add a client scriptlet

1. On the **Tools** menu, click the **Command Script Editor...** command.
The **Select Script Language** dialog box is displayed if no Command Script was created yet.
2. In the **Script Language:** list, select the required entry.
The **Command Script Editor** dialog box is displayed.
3. In the left pane of the **Command Script Editor** dialog box, right-click ClientScript and click **New Scriptlet**.
A new scriptlet is added.
4. Enter your code.

To delete a scriptlet:

1. Open the **Command Script Editor** dialog box.
2. Click the **Server Script** tab or the **Client Script** tab as required.

- In the Event Tree, right-click the required event and click . The scriptlet is removed.

To exit the Command Script Editor dialog box:

- Click .

Refer to

- Command Script Editor dialog box, page 291*

9.2 Configuring a Command Script to be started automatically

Main window > **Alarms** >  or  > **Alarm Options** column > ...

You configure a Client Command Script to be started in the following cases:

- Workstation starts up.
- User accepts an alarm.

To configure a Command Script at workstation startup:

See Configuring a startup Command Script.

To configure a Command Script after user has accepted an alarm:

- Click the **Workflow** tab.
- In the **Execute the following Client Script when alarm is accepted:** list, select the desired Client Script.
This script is started as soon as a user accepts the selected alarm.

Refer to

- Alarm Options dialog box, page 297*
- Configuring a startup Command Script (settings page), page 92*

9.3 Importing a Command Script

Main window

You can import Command Scripts that have been developed on another computer. The file must be written in the same scripting language that you used on your system.

To import a Command Script:

- On the **Tools** menu, click the **Command Script Editor...** command.
The **Command Script Editor** dialog box is displayed.
- Click .
- Select the required script file and click **OK**.

Refer to

- Command Script Editor dialog box, page 291*

9.4 Exporting a Command Script

Main window

You can export Command Scripts that have been developed on another computer.

To export a Command Script:

- On the **Tools** menu, click the **Command Script Editor...** command.
The **Command Script Editor** dialog box is displayed.

2. Click  .
The dialog box for saving a file is displayed.
3. Type the required script file name and click **OK**.

Refer to

- *Command Script Editor dialog box, page 291*

9.5

Configuring a startup Command Script (settings page)

Main window > **Devices** > Expand  >  > **Settings** page

You configure a Command Script to be started when the Operator Client on the selected workstation is started.

You must create a corresponding Command Script.

For creating a Command Script, see *Managing Command Scripts, page 90*.

To configure a startup script:

- ▶ In the **Startup script:** list, select the required Command Script.

Refer to

- *Workstation page, page 134*



10 Managing configuration data

Main window

You must activate the current configuration to make it valid for the Management Server and Operator Client. The system reminds you to activate when exiting the Configuration Client. Every activated configuration is saved with the date and with a description if required.

At every point in time you can restore a recently activated configuration. All configurations saved in the meantime get lost.

You can export the current configuration in a configuration file and import this file later. This restores the exported configuration. All configurations saved in the meantime get lost.

- Click  to save the settings.
- Click  to undo the last setting.
- Click  to activate the configuration.

10.1 Activating the working configuration

Main window

You activate the currently working configuration. The Operator Client uses the activated configuration after the next start if the user accepted it. If the activation is enforced, all open instances of the Operator Client in the network exit and start again. The user of each Operator Client instance usually does not have to log on again.

You can configure a delayed activation time. If you configure a delayed activation time, the working configuration is not activated at once but at the time configured. If you configure another activation time later (delayed or not does not matter), this time is active now. The first configured activation time is removed.

When you exit the Configuration Client the system reminds you to activate the current working copy of the configuration.

You cannot activate a configuration that contains a device without password protection.



Notice!

If the activation is enforced, each instance of Operator Client restarts when the configuration is activated. Avoid unnecessary activations. Perform activations preferably in the night or during time periods with low activities.



Notice!

If your system contains devices that are not protected by a password, you must secure these devices before you can activate. You can deactivate this password enforcement.

To activate the currently working configuration:

1. Click  .
The **Activate configuration** dialog box is displayed.
If your configuration contains devices that are not protected by a password, you cannot activate. In this case the **Protect Devices with Default Password...** dialog box is displayed.
Follow the instructions in this dialog box and click **Apply** .
The **Activate configuration** dialog box is displayed again.

2. If appropriate, enter a delayed activation time. By default, the present point in time is configured as activation time. If you do not change the delayed activation time, the activation is performed immediately.
If appropriate, click to check **Force activation for all Operator Clients**.
3. Type a description and click **OK**.
The current configuration is activated.
Each Operator Client workstation is instantly restarted, if connected to the network and the activation is enforced. If a workstation is not connected, it is restarted as soon it is connected again.
If you configured a delayed activation time, the configuration will be activated later.

Note: Delayed-activation is not executed as long as the user is logged on to the Configuration Client.

Refer to

- *Protect Devices with Global Default Password dialog box (Hardware menu), page 105*
- *Activate Configuration dialog box (System menu), page 104*

10.2 Activating a configuration

Main window

You can activate a previous version of the configuration that you have saved earlier.

To activate a configuration:

1. On the **System** menu, click **Activation Manager...**
The **Activation Manager** dialog box is displayed.
2. In the list, select the configuration you want to activate.
3. Click **Activate**.
A message box is displayed.
4. Click **OK**.
The **Activate configuration** dialog box is displayed.
5. If appropriate, click to check **Force activation for all Operator Clients**. Each Operator Client workstation is automatically restarted to activate the new configuration. The user cannot refuse the new configuration.
If **Force activation for all Operator Clients** is not checked, on each Operator Client workstation a dialog box appears for some seconds. The user can refuse or accept the new configuration. The dialog box is closed after a few seconds without user interaction. In this case the new configuration is not accepted.

Refer to

- *Activate Configuration dialog box (System menu), page 104*
- *Activation Manager dialog box (System menu), page 104*

10.3 Exporting configuration data

Main window

You can export the device configuration data of BVMS in a .zip file. This .zip file contains the database file (`Export.bvms`) and the user data (.dat file).

You can use these files for restoring a system configuration that has been exported before on the same (Enterprise) Management Server or for importing it on another (Enterprise) Management Server. The user data file cannot be imported but you can use it to manually restore the user configuration.

To export configuration data:

1. On the **System** menu, click **Export Configuration....**
The **Export Configuration File** dialog box is displayed.



Note: If your current working copy configuration is not activated ( is active), you export this working copy and not the activated configuration.

2. Click **Save**.
3. Enter a filename.
The current configuration is exported. A .zip file with database and user data is created.

Refer to

- *Importing configuration data, page 95*

10.4**Importing configuration data**

Main window

The following use cases are covered:

- Importing a configuration that has been exported (backup has been performed) before on the same server
- Importing a configuration template that has been prepared and exported on another server
- Importing the configuration of an earlier BVMS version.

You can only import a configuration if the latest changes of the current working copy are saved and activated.

For importing the configuration data you need the appropriate password.

You cannot import user data.

To import the configuration:

1. On the **System** menu, click **Import Configuration....**
The **Import Configuration File** dialog box is displayed.
2. Select the desired file for import and click **Open**.
The **Import Configuration...** dialog box is displayed.
3. Enter the appropriate password and click **OK**.
The Configuration Client is restarted. You must logon again.
The imported configuration is not activated but editable in Configuration Client.

**Notice!**

If you want to continue editing the configuration that has been activated for your Management Server, perform a rollback in the **Activate configuration** dialog box.

Refer to

- *Exporting configuration data, page 94*

10.5**Exporting configuration data to OPC**

Main window

You can export the device configuration data of BVMS in an XML file to import it in an OPC Server application. The file must be stored in the bin directory of your BVMS installation.

For configuring a BVMS - BIS connection, the BVMS - BIS Connectivity installation manual and the BVMS OPC Server technical service note are available.

**Notice!**

Install BIS server and BVMS Management Server on different computers.
If both the servers run on the same computer, the performance of the systems is reduced.
Additionally serious software crashes can appear.

To export configuration data:

1. On the **System** menu, click **Export Device Information for OPC...**
The **Export Device Information File** dialog box is displayed.
2. Enter a file name and click **Save**.
The file is saved.
You can import this file in your OPC server application.

10.6 Checking the status of your encoders/decoders

Main window > **Hardware** menu > **Device Monitor...** command > **Device Monitor** dialog box
You can check the status of all activated encoders/decoders in the Device Tree.

Refer to

- *Device Monitor dialog box (Hardware menu), page 110*

10.7 Configuring SNMP monitoring

Main window

To configure:

1. On the **Settings** menu, click **SNMP Settings...**
The **SNMP Settings** dialog box is displayed.
2. Make the required settings and click **OK**.

To disable SNMP GetRequest:

- ▶ In the **SNMP GET port** field, delete the content of the field.
BVMS no longer listens to SNMP GetRequest.

Refer to

- *SNMP Settings dialog box (Settings menu), page 114*

10.8 Creating a report

Main window

You can create reports where information on the current configuration is collected.

To create a report:

1. On the **Reports** menu, click the desired command.
The corresponding dialog box is displayed.
2. Click **CSV Export**.
3. Enter path and filename for the new report.
4. Open the CSV file in Microsoft Excel or another spreadsheet application to check the content.

Refer to

- *Recording Schedules dialog box, page 113*
- *Task Schedules dialog box, page 113*
- *Cameras and Recording Parameters dialog box, page 113*
- *Stream Quality Settings dialog box, page 113*
- *Event Settings dialog box, page 113*

- *Compound Event Settings dialog box, page 113*
- *Alarm Settings dialog box, page 113*
- *Configured Users dialog box, page 113*
- *User Groups and Accounts dialog box, page 114*
- *Operating Permissions dialog box, page 114*

11 Configuration examples

This chapter contains examples on how to configure selected devices in BVMS.







11.1 Adding a Bosch ATM/POS bridge

This example describes how to set up a Bosch ATM/POS Bridge.

Configuring the ATM/POS Bridge

1. Ensure that the device is powered.
2. To configure the IP address and subnet mask of the device connect it to a COM port of your computer with a RS232 cable (use the specified Bosch cable for connection). See the Installation Manual of the Bosch ATM/POS Bridge for details.
3. On this computer, start a Hyper terminal session (usually: **Start > Programs > Accessories > Communications > Hyper Terminal**).
4. Type a name for the session and click **OK**.
5. Select the COM port number and click **OK**.
6. Enter the following COM port settings:
 - 9600 bits/s
 - 8 data bits
 - no parity
 - 1 stop bit
 - hardware flow control
 Click **OK**.
7. Press F1 for displaying the system options menu of the device.
8. Enter 1 to set the IP address and the subnet mask as required.
9. Leave the default settings for the ports:
 - port1: **4201**
 - port2: **4200**

Adding the ATM/POS Bridge to BVMS



1. Connect the device to your BVMS network.
2. Start Configuration Client.
3. Click **Devices**, expand the Logical Tree, expand , right-click , click **Add Bosch ATM/POS-Bridge**.
The **Add Bosch ATM/POS-Bridge** dialog box is displayed.
4. Type a name as desired and type the settings that you configured earlier.
5. Click the **Inputs** tab and select the required inputs.
6. Click  to save the settings.
7. Click **Events**.
8. Expand , expand **POS Bridge Input**, click **Data Input**.
9. In the **Trigger Alarm** list, select **Always** to ensure that this event always triggers an alarm. If you want the event trigger an alarm only during a certain time span, select a schedule.
10. Click  to save the settings.
11. Click **Alarms**.
12. Configure the desired alarm settings for this event.
13. Click  to save the settings and click  to activate the configuration.

14. Perform a test to ensure that the alarm is working as desired.

11.2 Adding a Bosch Allegiant input alarm

After a Bosch Allegiant device is added to BVMS, you add Allegiant alarm inputs.

1. On the Device Tree, click the Allegiant device entry.
2. Click the **Inputs** tab and click **Add Input**.
3. Add the desired input alarms.
4. Click **Events**.
5. In the Event Tree, expand **Allegiant Devices**, expand **Allegiant Input**, and click **Input Closed** or **Input Opened** (depends on your application).
6. In the **Trigger Alarm** list, select **Always** to ensure that an event always triggers an alarm. If you want the event trigger an alarm only during a certain time span, select a schedule.

7. Click  to save the settings and click  to activate the configuration.
8. Perform a test to ensure that the alarm is working as desired.

11.3 Adding and configuring 2 Dinion IP cameras with VRM recording

This section describes how to add 2 Dinion IP cameras for VRM recording, how to configure different recording settings and how to configure Forensic Search for these cameras.

Prerequisite:

VRM and iSCSI devices are properly configured.

This means:

- The VRM is added to the Device Tree.
- An iSCSI device with configured target and LUN is assigned to this VRM.

To add the IP cameras to an existing VRM:

Main window > **Devices** > Expand 

1. Right-click  and click **Add Encoder**.
The **Add Encoder** dialog box is displayed.
2. Type the IP address of the IP camera and select the encoder type (Dinion IP).
Click **OK**.
Repeat this step for the other IP camera.

To add the IP cameras to the Logical Tree:

Main window > **Maps and structure**

- ▶ Drag the cameras to the Logical Tree.

To change camera properties:

Main window > **Cameras and recording** >  >  tab

1. In the **Live Video** column, configure the quality of live display. For these devices, you can only set the live quality per camera, not schedule dependent.
2. Make the appropriate settings in the other columns.

To configure recording settings for the cameras:

1. Click .
2. Select the respective device family.
3. Select the respective available recording setting.

4. Select the respective recording schedule, for example **Day**.
5. Under **Continuous or Pre-alarm Recording**, select the desired recording mode, stream and quality.
If you select in the recording mode **Pre-alarm**, the **Duration** parameter is available to select the alarm recording time before the alarm in seconds.
6. Under **Alarm Recording**, in the **Duration** column, click a cell and type the desired recording time after the alarm happens in seconds.
7. Repeat the previous steps to configure the recording settings for the other device family camera.

To enable Forensic Search on a workstation:

Main window > **Devices** > Expand 

1. Click the  icon of your workstation.
2. Click the **Settings** tab.
3. Click to select the check box.

12 Global Configuration Client windows



Notice!

BVMS Viewer offers only basic features. Advanced features are included in BVMS Professional. For detailed information about the different BVMS editions refer to www.boschsecurity.com and the BVMS Quick Selection Guide: [BVMS Quick Selection Guide](#).





This chapter contains information on some basic application windows available in BVMS Configuration Client.



12.1 Configuration window

Main window

Allows you to configure your system. The buttons in the toolbar represent the various pages which you must configure to get a running system. Their sequence represents the recommended workflow of configuration.

- ▶ Click a tree item to display the available property pages.

Devices	Click to display the Devices page with all devices connected to the system.
Maps and structure	Click to display the Maps and structure page with Logical Tree, Device Tree, and maps.
Schedules	Click to display the Recording Schedules and Task Schedules page.
Cameras and recording	Click to display the Cameras and recording page with the Camera Table and the recording settings of all cameras.
Events	Click to display the Events page.
Alarms	Click to display the Alarms page.
User groups	Click to display the User groups page with all users.
	Click to save the changed settings of the current window.
	Click to restore the saved settings of the current window. Note: Only settings done in BVMS are restored, not the settings that have been made directly on the device. This may lead to no longer accessible devices.
	Click to display the Activate configuration dialog box.
	Click to delete the selected item. (Not available on every page).
	Click to rename the selected item. (Not available on every page).

	Click to display help information on the current window.
	Click to update the state information for all devices and the device capabilities if required (not available on every page). You can update the state of a single device: Right-click the device and click Refresh state . Note: When you have a large system with several 1000 devices configured, the process of updating states and device capabilities can take a long time.

12.2

Menu commands

System menu commands

Save Changes	Saves all changes made on this page.
Undo All Changes on Page	Restores the settings of this page since the last saving.
Activation Manager...	Displays the Activation Manager dialog box.
Export Configuration...	Displays the Export Configuration File dialog box.
Import Configuration...	Displays the Import Configuration File dialog box.
Export Device Information for OPC...	Displays a dialog box for creating a configuration file that you can import in a 3rd party management system.
Exit	Exits the program.

Hardware menu commands

Initial Device Scan...	Displays the Initial Device Scan dialog box.
Protect Devices with Default Password...	Displays the Protect Devices with Global Default Password dialog box.
Protect iSCSI storages with CHAP password...	Displays the Protect iSCSI storages with CHAP password dialog box.
Change device passwords...	Displays the Change device passwords dialog box.
Update device firmware...	Displays the Update device firmware dialog box.
Change device IP and network settings...	Displays the Change device IP and network settings dialog box.
Device Monitor...	Displays the Device Monitor dialog box.

Tools menu commands

Command Script Editor...	Displays the Command Script Editor dialog box
Resource Manager...	Displays the Resource Manager dialog box.

Sequence Builder...	Displays the Sequence Builder dialog box.
Resource Converter	Displays the Resource Converter dialog box if map resources are available.
License Manager...	Displays the License Manager dialog box.
License Inspector...	Displays the License inspector dialog box.

Reports menu commands

Recording Schedules...	Displays the Recording Schedules report dialog box.
Scheduled Recording Settings...	Displays the Scheduled Recording Settings report dialog box.
Task Schedules...	Displays the Task Schedules report dialog box.
Cameras and Recording Parameters...	Displays the Cameras and Recording Parameters report dialog box.
Stream Quality Settings...	Displays the Stream Quality Settings report dialog box.
Event Settings...	Displays the Event Settings report dialog box.
Compound Event Settings...	Displays the Compound Event Settings report dialog box.
Alarm Settings...	Displays the Alarm Settings report dialog box.
Configured Users...	Displays the Configured Users report dialog box.
User Groups and Accounts...	Displays the User Groups And Accounts report dialog box.
Device Permissions...	Displays the Device Permissions report dialog box.
Operating Permissions...	Displays the Operating Permissions report dialog box.
Configuration Permissions...	Displays the Configuration Permissions report dialog box.
User Group Permissions...	Displays the User Group Permissions report dialog box.
Security Settings...	Displays the Security Settings report dialog box.
Bypassed devices...	Displays the Bypassed devices report dialog box.

Settings menu commands

Alarm Settings...	Displays the Alarm Settings dialog box.
SNMP Settings...	Displays the SNMP Settings dialog box.
LDAP server settings...	Displays the LDAP server settings dialog box.
Define LDAP user group order...	Displays the Define LDAP user group order... dialog box.
Access token settings...	Displays the Access token settings dialog box.

Trusted certificate settings...	Displays the Trusted certificate settings dialog box. Note: The Trusted certificate settings... menu is only available if you start the Configuration Client with admin permissions and if the user who logs in has the Configure User Groups/Enterprise Accounts permission.
Set Recording Qualities...	Displays the Stream Quality Settings dialog box.
Options...	Displays the Options dialog box.

Help menu commands

Display Help	Displays the BVMS Application Help.
About...	Displays a dialog box containing information on the installed system, e.g., the version number.

12.3

Activation Manager dialog box (System menu)

Main window > **System** menu > **Activation Manager...** command

Allows you to activate the current configuration or to rollback to a previous configuration.

Activation Manager ×

Please select the configuration you want to activate. If you activate an older configuration, the system will perform a rollback and the newer configurations will be removed.

Date & Time	User	Description
Working Copy		
11/25/2021 2:01:01 PM	TECHDOC-01 : Admin	
11/17/2021 11:09:06 AM	TECHDOC-01 : SYSTEM	Migrated to Version: 11.1.0.335
11/2/2021 12:35:57 PM	TECHDOC-01 : SYSTEM	Migrated to Version: 11.1.0.301
10/11/2021 2:41:12 PM	TECHDOC-01 : SYSTEM	Added event type data to configuration (BVMS version 11.1.0.232)
10/11/2021 2:40:58 PM	TECHDOC-01 : SYSTEM	Migrated to Version: 11.1.0.232
7/26/2021 6:01:33 PM	TECHDOC-01 : Admin	
7/26/2021 2:39:38 PM	TECHDOC-01 : SYSTEM	Migrated to Version: 11.1.0.74
5/11/2021 12:43:21 PM	TECHDOC-01 : SYSTEM	Migrated to Version: 11.0.0.1001
3/29/2021 2:31:47 PM	TECHDOC-01 : Admin	
3/18/2021 1:08:18 PM	TECHDOC-01 : Admin	
3/18/2021 1:05:00 PM	TECHDOC-01 : Admin	
3/18/2021 1:04:02 PM	TECHDOC-01 : Admin	
3/18/2021 1:01:44 PM	TECHDOC-01 : Admin	

⬆️ Exported configuration ● Currently active configuration
⬆️ Imported configuration ⬇️ Rollback: This configuration will be removed after activation

Generate new Management Server ID

Activate
Cancel

Activate

Click to display the **Activate configuration** dialog box.

Refer to

- *Activating the working configuration, page 93*
- *Activating a configuration, page 94*

12.4

Activate Configuration dialog box (System menu)



Main window >

Allows you to type a description for the working copy of the configuration to be activated.

Set delayed-activation time

Click to select a delayed-activation time.

Note: Delayed-activation is not executed as long as the user is logged on to the Configuration Client.

Force activation for all Operator Clients

If checked, each Operator Client workstation is automatically restarted to activate the new configuration. The user cannot refuse the new configuration.

If not checked, on each Operator Client workstation a dialog box appears for some seconds. The user can refuse or accept the new configuration. The dialog box is closed after a few seconds without user interaction. In this case the new configuration is not accepted.

Refer to

– *Activating the working configuration, page 93*

12.5 Initial Device Scan dialog box (Hardware menu)

Main window > **Hardware** menu > **Initial Device Scan...** command

Displays the devices which have duplicate IP addresses or a default IP address (192.168.0.1). Allows you to change such IP addresses and subnet masks.

You must enter the correct subnet mask before changing an IP address.

12.6 Protect Devices with Global Default Password dialog box (Hardware menu)

Main window > **Hardware** menu > **Protect Devices with Default Password...** command
or



Main window >

This dialog box appears, if an activation is pending and if your configuration contains devices that are not protected by a password. It allows you to enter a global default password that is applied on all affected devices.

Update states and capabilities

Click to rescan the network for devices that are not protected by a password.

Global default password

Type in a password that is used for all currently not protected devices.

Show passwords

Click to enable that all passwords in this dialog are visible.

Enforce password protection on activation

Click to select this checkbox. If enabled, you must apply a global default password for devices that are not protected by a password.

Apply

Click to apply the global default password.

The **Changing Passwords** dialog box is displayed. The changes of passwords are listed.

Click **OK** to close.

If you started with activating your configuration, the **Activation Manager** dialog box is displayed.

Refer to

- *Activating the working configuration, page 93*

12.7**Protect iSCSI storages with CHAP password dialog box (Hardware menu)**

Use this dialog to set CHAP passwords on iSCSI and VRM devices. The system automatically transfers these passwords to the accounts **User** and **Destination** of encoders, decoders and VSG devices.

On newly added devices, the passwords are set automatically when you activate the configuration.

Note: Setting an empty CHAP password removes the CHAP password on iSCSI and VRM devices.

Notice!

- On all DSA E-Series, the CHAP password is set automatically.
- VRM devices transfer the CHAP password to the encoders. But you have to set the CHAP password on the respective iSCSI device to ensure recording.
- On all DIVAR IP devices, you have to manually set the CHAP password. See the respective DIVAR IP manual for further instructions. Otherwise recording stops or playback does not work.

Global CHAP password

Type the iSCSI CHAP password which is necessary to authenticate at the iSCSI storage device and to enable a direct playback from the iSCSI.

Confirm global CHAP password

Confirm the iSCSI CHAP password.

Show password

Click to enable that the entered password is displayed. Be careful that nobody can spy out this password.

Apply

Click to apply the CHAP password.

Note: Check the operation result. It is possible that you have to set the CHAP password manually on some iSCSI devices.

12.8**Change device passwords dialog box (Hardware menu)**

Main window > **Devices** >  **Change device passwords** > **Change device passwords** dialog box

or

Main window > **Hardware** menu > **Change device passwords...** command > **Change device passwords** dialog box



Click to refresh the state information for all devices. You can refresh the state of a single device: Right-click the device and click **Refresh state**.

Note: When you have a large system with several 1000 devices configured, the process of refreshing states can take a long time.



Click to select all available devices at once.

Show passwords

Select the check box when you want the configured passwords being displayed in readable form.

To search for items:

- ▶ In the search field type a string and press the ENTER key to filter the displayed items.

Only items containing the string and their corresponding parent items (only in trees) are displayed. The count of filtered items and the total count of items is provided.

Note: Enclose strings with double quotes to find them exactly, for example "Camera 1" exactly filters the cameras with this name, not camera 201.

Note: Only if the **Show passwords** check box is selected, it is possible to also search for passwords.

The table allows you to set the following properties of the available IP devices:

- Service password
- User password
- Live password
- Destination password

To change the password for IP devices:

1. Select the required device.
2. Right-click the selected device and click **Edit password...**
The **Change device passwords** dialog box is displayed.
3. Select the required password type.
4. Type in the new password.
5. Click **OK**.
The new password is updated in the selected device.

To change the settings for multiple devices:

See *Configuring multiple encoders / decoders*, page 220.

12.9

Update device firmware dialog box (Hardware menu)

Main window > **Hardware** menu > **Update device firmware...** command > **Update device firmware** dialog box



Click to refresh the state information for all devices. You can refresh the state of a single device: Right-click the device and click **Refresh state**.

Note: When you have a large system with several 1000 devices configured, the process of refreshing states can take a long time.



Click to select all available devices at once.



Click to update the firmware version.

To search for items:

- ▶ In the search field type a string and press the ENTER key to filter the displayed items.

Only items containing the string and their corresponding parent items (only in trees) are displayed. The count of filtered items and the total count of items is provided.

Note: Enclose strings with double quotes to find them exactly, for example "Camera 1" exactly filters the cameras with this name, not camera 201.

To update the firmware version:

1. Select the required device.
2. Click **Update Firmware**.
A Configuration Client information window is displayed.
3. Click **OK**.
The file explorer opens.
4. Select the file containing the update.
5. Click **Open**.
The **Firmware Upload Status** window opens.
6. Click **Start** to start the upload.
7. Click **Close**.
The firmware is updated.

To change the settings for multiple devices:

See *Configuring multiple encoders / decoders*, page 220.

12.10

Change device IP and network settings dialog box (Hardware menu)

Main window > **Hardware** menu > **Change device IP and network settings...** command > **Change device IP and network settings** dialog box



Click to refresh the state information for all devices. You can refresh the state of a single device: Right-click the device and click **Refresh state**.

Note: When you have a large system with several 1000 devices configured, the process of refreshing states can take a long time.



Click to select all available devices at once.

To search for items:

- ▶ In the search field type a string and press the ENTER key to filter the displayed items.
Only items containing the string and their corresponding parent items (only in trees) are displayed. The count of filtered items and the total count of items is provided.

Note: Enclose strings with double quotes to find them exactly, for example "Camera 1" exactly filters the cameras with this name, not camera 201.

The table allows you to set the following properties of the available IP devices:

- Display name
- IP address
- Subnet mask
- Gateway IP

**Notice!**

Instead of using the commands, you can type the appropriate settings in the required field.

To set the display name for IP devices:

1. Select the required device.
2. Right-click the selected device and click **Set Display Names...** The **Set Display Names** dialog box is displayed.
3. In the **Start with:** field, type the first string.
4. Click **Calculate**. In the **End with:** field, the last string of the range for the selected device is displayed.
5. Click **OK**.
6. In the **Change device IP and network settings** dialog box, click **Apply**.
The calculated name is updated in the selected device.

Set display names dialog box**Start with:**

Type the first name.

End with:

Displays the last name for the selected devices after having clicked **Calculate**.

Calculate

Click to calculate the range of display names for the selected devices.

To set the IP address for IP devices:

1. Select the required device.
2. Right-click the selected device and click **Set IP Addresses....** The **Set IP Addresses** dialog box is displayed.
3. In the **Start with:** field, type the first IP address.
4. Click **Calculate**. In the **End with:** field, the last IP address of the range for the selected device is displayed.
5. Click **OK**.

- In the **Change device IP and network settings** dialog box, click **Apply**.
The new IP address is updated in the selected device.

Set IP addresses dialog box

Start with:

Type the first IP address..

End with:

Displays the last IP address for the selected devices after having clicked **Calculate**.

Calculate

Click to calculate the range of IP addresses for the selected devices.

To set subnet mask / gateway ID for IP devices:

- Click in the required field.
- Type the appropriate value.
- Click **Apply**.
The new value is updated in the selected device.

Apply

Click to configure the devices with the entered values without closing the dialog box.

To change the settings for multiple devices:

See *Configuring multiple encoders / decoders*, page 220.

12.11

Device Monitor dialog box (Hardware menu)

Main window > **Hardware** menu > **Device Monitor...** command > **Device Monitor** dialog box

Allows you to check the status of the encoders/decoders in your Device Tree that are active in your BVMS.

Display Name

Device name that was configured in BVMS.

Network Address

IP address of the device.

State

The following states can be displayed:

- **Configured:** Configuration of this device is activated.
- **Configuration mismatch:** Configuration of this device is not activated.
- **Unknown:** Status could not be determined.
- **Not Connected:** Not connected.

Last Check

Date and time when the dialog was started and the check was performed. As long as the dialog box is displayed, the devices are not checked again.

Refer to

- *Checking the status of your encoders/decoders*, page 96

12.12

Command Script Editor dialog box (Tools menu)

See *Command Script Editor dialog box*, page 291 for details.

Refer to

- *Command Script Editor dialog box, page 291*

12.13 Resource Manager dialog box (Tools menu)

See *Resource Manager dialog box, page 251* for details.

Refer to

- *Resource Manager dialog box, page 251*

12.14 Sequence Builder dialog box (Tools menu)

See *Sequence Builder dialog box, page 254* for details.

Refer to

- *Sequence Builder dialog box, page 254*

12.15 License Manager dialog box (Tools menu)

Main window > **Tools** menu > **License Manager...** command

Allows you to license the BVMS package that you have ordered and to upgrade with additional features.

License status

Displays the licensing status.

System fingerprint

For support purposes we recommend to provide the **System fingerprint**.

Installation site

When activating your base license in the Bosch Remote Portal, you provide information about the installation site of your system. This information displays here.

Note: You can also provide this information in other licenses, but only the information provided in the base license displays here.

Licenses

1. Click **Add** to add your licenses.
The **Add license** dialog box is displayed.
2. Follow the instructions in the dialog.

Effective license

Displays the effective base license that you have activated.

Features

- ▶ Click **License Inspector...**

The **License inspector** dialog box displays.

Displays the quantity of the licensed features that are currently installed.

You can check whether the number of installed BVMS licenses exceeds the number of purchased licenses.

Installed BVMS version

Displays the currently installed BVMS version, for example 11.0.

Licensed BVMS versions

Displays all BVMS versions that are included and supported in the current provided license file.

For example: BVMS 11.0 and all upcoming minor versions BVMS 11.x.

Activation date

Displays the activation date of your installed BVMS version.

Expiration date

Displays the expiration date of your installed BVMS version. An Expiration date is only applicable when you install an emergency license or a sales demo license.

Software Maintenance Agreement**Expiration date**

If you have purchased and activated any Software Maintenance Agreement, the expiration date displays here.

Refer to

- *Activating the software licenses, page 76*
- *Add license dialog box, page 112*
- *License Inspector dialog box (Tools menu), page 112*

12.15.1**Add license dialog box**

Main window > **Tools** menu > **License Manager...** command > **Licenses** > **Add**

Allows you to add your purchased licenses or demo licenses from the Bosch Remote Portal website remote.boschsecurity.com to your BVMS system.

To add your licenses follow the instructions in the dialog.

For further information refer to the respective BVMS licensing whitepaper.

12.16**License Inspector dialog box (Tools menu)**

Main window > **Tools** menu > **License Inspector...** command > **License inspector** dialog box

Displays the quantity of the licensed features that are currently installed.

You can check whether the number of installed BVMS licenses exceeds the number of purchased licenses.

Note: If the current system configuration exceeds the limits of the currently installed licenses, you can not activate the configuration.

12.17**Workstation monitoring dialog box (Tools menu)**

Main window > **Tools** menu > **Workstation monitoring...** command > **Workstation monitoring** dialog box

Displays a list of all workstations that are currently connected to the BVMS Management Server.

Note: The list displays all connected Operator Clients and Cameo SDK clients.

To disconnect a workstation:

1. Select the respective entry from the list.
2. Click **Disconnect**.

Note: The function is only active if the user has the respective permission.

3. Click **Yes**.

The list entry is removed if the corresponding Operator Client logs off successfully.

Note: You can only disconnect Operator Client workstations.

12.18**Reports dialog boxes (Reports menu)**

This chapter covers all dialog boxes which are available for configuration reports.

Refer to

– *Creating a report, page 96*

12.18.1**Recording Schedules dialog box**

Main window > **Reports** menu > **Recording Schedules...** command

Lists the configured recording schedules.

- ▶ Click **CSV Export** to save all information of this dialog box in a CSV file.

12.18.2**Scheduled Recording Settings dialog box**

Main window > **Reports** menu > **Scheduled Recording Settings...** command

Lists the configured scheduled recording settings.

- ▶ Click **CSV Export** to save all information of this dialog box in a CSV file.

12.18.3**Task Schedules dialog box**

Main window > **Reports** menu > **Task Schedules...** command

Lists the configured task schedules.

- ▶ Click **CSV Export** to save all information of this dialog box in a CSV file.

12.18.4**Cameras and Recording Parameters dialog box**

Main window > **Reports** menu > **Cameras and Recording Parameters...** command

Lists the recording parameters that are configured in the Camera Table and the Recording Table.

- ▶ Click **CSV Export** to save all information of this dialog box in a CSV file.

12.18.5**Stream Quality Settings dialog box**

Main window > **Reports** menu > **Stream Quality Settings...** command

Lists the configured stream quality settings of all cameras.

- ▶ Click **CSV Export** to save all information of this dialog box in a CSV file.

12.18.6**Event Settings dialog box**

Main window > **Reports** menu > **Event Settings...** command

Lists the events for which a schedule for triggering an alarm is configured.

- ▶ Click **CSV Export** to save all information of this dialog box in a CSV file.

12.18.7**Compound Event Settings dialog box**

Main window > **Reports** menu > **Compound Event Settings...** command

Lists the all compound events.

- ▶ Click **CSV Export** to save all information of this dialog box in a CSV file.

12.18.8**Alarm Settings dialog box**

Main window > **Reports** menu > **Alarm Settings...** command

Lists all alarm settings of the configured alarms, including the settings in the **Alarm Options** dialog box.

- ▶ Click **CSV Export** to save all information of this dialog box in a CSV file.

12.18.9**Configured Users dialog box**

Main window > **Reports** menu > **Configured Users...** command

Lists the users who are permitted to log on to the Operator Client.

- ▶ Click **CSV Export** to save all information of this dialog box in a CSV file.

12.18.10 **User Groups and Accounts dialog box**

Main window > **Reports** menu > **User Groups and Accounts...** command

Lists the configured user groups, Enterprise Accounts, Enterprise User Groups and dual authorization groups.

- ▶ Click **CSV Export** to save all information of this dialog box in a CSV file.

12.18.11 **Device Permissions dialog box**

Main window > **Reports** menu > **Device Permissions...** command

Lists the permissions for using the configured devices for each user group.

- ▶ Click **CSV Export** to save all information of this dialog box in a CSV file.

12.18.12 **Operating Permissions dialog box**

Main window > **Reports** menu > **Operating Permissions...** command

Lists the permissions for using Operator Client for each user group.

- ▶ Click **CSV Export** to save all information of this dialog box in a CSV file.

12.18.13 **Configuration Permissions dialog box**

Main window > **Reports** menu > **Configuration Permissions...** command

Lists the permissions for using Configuration Client for each user group.

- ▶ Click **CSV Export** to save all information of this dialog box in a CSV file.

12.18.14 **User Group Permissions dialog box**

Main window > **Reports** menu > **User Group Permissions...** command

Lists the permissions for configuring user groups for each user group.

- ▶ Click **CSV Export** to save all information of this dialog box in a CSV file.

12.18.15 **Security Settings dialog box**

Main window > **Reports** menu > **Security Settings...** command

Lists the configured security settings for each user group and Enterprise User Groups.

- ▶ Click **CSV Export** to save all information of this dialog box in a CSV file.

12.18.16 **Application permissions dialog box**

Main window > **Reports** menu > **Application permissions...** command

Lists all user groups and their application permissions.

- ▶ Click **CSV Export** to save all information of this dialog box in a CSV file.

12.18.17 **Bypassed devices dialog box**

Main window > **Reports** menu > **Bypassed devices...** command

Lists all configured devices and which devices are bypassed.

- ▶ Click **CSV Export** to save all information of this dialog box in a CSV file.

12.19 **Alarm Settings dialog box (Settings menu)**

See *Alarm Settings dialog box*, page 295 for details.

12.20 **SNMP Settings dialog box (Settings menu)**

Main window > **Settings** menu > **SNMP Settings...** command

Allows you to configure SNMP monitoring on your Management Server computer. You specify for which event an SNMP trap is sent, some additional information on your system, and the IP addresses of the computers which are planned to receive SNMP traps from BVMS.

The server sends SNMP traps when events occur. You can receive these traps with the SNMP receiver in Configuration Client using the **SNMP Trap Logger** tool. You can also use another software that can receive SNMP traps.

The SNMP agent in BVMS supports SNMP GetRequest. When an SNMP manager software (for example iReasoning MIB Browser) sends an SNMP GetRequest to the BVMS Management Server then the Management Server sends a corresponding response message.

The MIB file is located in the following file:

```
<installation_directory>\Bosch\VMS\bin\BVMS.mib
```

Only SNMPv1 and v2 are supported.

Note: SNMPv1 and SNMPv2 are not completely compatible. Hence we recommend not using SNMPv1 and SNMPv2 together.

SNMP GET port

Type in the port number for SNMP GetRequest. This is the port where the SNMP agent of the BVMS Management Server listens for SNMP GetRequest.

Note: BVMS does not use the standard port number 161 for SNMP GetRequest, because this port is possibly used by the SNMP agent of the computer where the BVMS Management Server is installed on.

The default value is 12544.

System contact

Type in contact data for your BVMS. You can retrieve this information with an SNMP GetRequest using the OID .1.3.6.1.2.1.1.4.

System description

Type in a description of your BVMS. You can retrieve this information with an SNMP GetRequest using the OID .1.3.6.1.2.1.1.5.

System location

Type in the location of your BVMS. This string should specify the physical location of the server computer, for example building, room number, rack-number, etc.

You can retrieve this information with an SNMP GetRequest using the OID .1.3.6.1.2.1.1.6.

Trap Receivers

Type the IP address of the computer where BVMS is supposed to send SNMP traps to.

Trap Filter

Click to select the events in the Event Tree to filter the SNMP traps that are sent.

Refer to

– *Configuring SNMP monitoring, page 96*

12.21

LDAP Server Settings dialog box (Settings menu)

Main window > **Settings** menu > **LDAP server settings...** command

You enter the LDAP server settings that are configured outside of BVMS. You will need the assistance of your IT administrator who set up the LDAP server for the following entries. All fields are mandatory except the fields in the **Test user / User group** group box.

LDAP server settings

LDAP server

Type the name or IP address of the LDAP server.

Port

Type the port number of the LDAP server (default HTTP: 389, HTTPS: 636)

Secure connection

Select the check box to activate secure data transmission.

Authentication mechanism

Negotiate selects the appropriate authentication protocol automatically.

Simple transmits the logon credentials unencrypted as clear text.

Proxy authentication**Anonymous**

Use to log on as a guest. Select this option if the LDAP server supports it and you are not able to configure a specific proxy user.

Use following credentials**User name**

Type the unique name of the proxy user. This user is required to allow the users of this BVMS user group to access the LDAP server.

Password

Type the proxy user password.

Test

Click to test whether the proxy user has access to the LDAP server.

LDAP basis for user

Type the unique name (DN = distinguished name) of the LDAP path in which you can search for a user.

Example for a DN of the LDAP basis: CN=Users,DC=Security,DC=MyCompany,DC=com

Filter for user

Select a filter used to search for a unique user name. Examples are predefined. Replace %username% with the actual user name.

LDAP basis for group

Type the unique name of the LDAP path in which you can search for groups.

Example for a DN of the LDAP basis: CN=Users,DC=Security,DC=MyCompany,DC=com

Filter for group member search

Select a filter used to search for a group member.

Examples are predefined. Replace %usernameDN% with the actual user name and his DN.

Group search filter

Do not leave this field empty. If there is no entry, you cannot assign an LDAP group to a BVMS user group.

Select a filter to find a user group.

Examples are predefined.

Test user / User group

The entries in this group box are not saved after clicking **OK**. They only serve for testing.

User name

Type the name of a test user. Omit the DN.

Password

Type the test user password.

Test user

Click to test whether the combination of user name and password is correct.

Group (DN)

Type the unique group name with which the user is associated.

Test group

Click to test the association of the user with the group.

Refer to

- *Selecting an associated LDAP group, page 337*

12.21.1**Associating an LDAP group**

You associate an LDAP group with a BVMS user group to give the users of this LDAP group access to the Operator Client. The users of the LDAP group have the access rights of the user group where you configure the LDAP group.

You probably need the help of the IT administrator who is responsible for the LDAP server. You configure LDAP groups in standard user groups or Enterprise User Groups.

**Notice!**

If an LDAP group is associated with a BVMS user group, users of this LDAP group can start the Operator Client using Single Sign-on.

**Notice!**

A LDAP user can be associated with more than one LDAP user group, which in turn are associated with a particular BVMS user group.

The LDAP user gets the permissions of the BVMS user group that is ordered above the other LDAP user groups, that are associated with this LDAP user.

To associate an LDAP group:

1. Click **LDAP server settings...**
The **LDAP server settings** dialog box is displayed.
2. Enter the settings of your LDAP server and click **OK**.

For detailed information on the various fields, follow the link to the appropriate application window below.

Refer to

- *LDAP Server Settings dialog box (Settings menu), page 115*
- *User Group Properties page, page 313*

12.22**Define LDAP user group order dialog box (Settings menu)**

Displays the **Change LDAP user group order** list. The list shows the LDAP user groups with their associated BVMS user groups and Enterprise User Groups. By drag and drop or using the up and down arrow buttons you can change the order of the groups.

**Notice!**

A LDAP user can be associated with more than one LDAP user group, which in turn are associated with a particular BVMS user group.

The LDAP user gets the permissions of the BVMS user group that is ordered above the other LDAP user groups, that are associated with this LDAP user.

12.23**Access token settings dialog box (Settings menu)**

Main window > **Settings** menu > **Access token settings...** command

If you have configured the logon to the Management Server by using an access token, you must define the token settings first.

A token is created by the Enterprise Management Server and must be signed by a certificate from a certificate store on the local computer. You have to identify the certificate in order to know which certificate to use.

Note: BVMS does not support certificates that use a Secure Hash Algorithm SHA-1 and have a key length smaller than 2048 bits.

Signing certificate properties

Type a properties string to identify the respective certificate.

Note: If more than one certificate matches the criteria, the newest currently valid certificate is used.

Follow the rules to type a valid properties string in the **Signing certificate properties** field:

- The string consists of one or multiple conditions.
- Conditions are separated by semicolons (;).
- Conditions are pairs of certificate property name and expected value, separated by an equals sign (=).
- Certificate property names may consist of one or multiple parts, separated by a period (.).
- Certificate property names and expected values are not case-sensitive.

Examples:

```
SubjectName.CN=BVMS Token Issuer;Parent.SubjectName.CN=BVMS Intermediate
```

- The Common Name part (CN) of the certificate's Subject name must be equal to the BVMS Token Issuer.
- Additionally, the Common Name part of the Subject Name of the certificate's parent must be equal to BVMS Intermediate. The parent is the certificate that was used to sign the current certificate.

```
Parent.Thumbprint=A95FF7C6EC374127174D3AFA8EA67C94E8E66C3F
```

- The thumbprint of the certificate's parent certificate must be as specified.

List of supported certificate property names:

Name	Return type
Thumbprint	String
SerialNumber	String
SubjectName	Distinguished name of subject
IssuerName	Distinguished name of issuer
Parent	Certificate that was used to sign the current certificate (Issuer CA)

List of supported property names on distinguished name:

Name	Return type
CN	String: Common name
OU	String: Organizational unit name
O	String: Organization name

Name	Return type
L	String: Locality name
S	String: State or province name
C	String: Country name

Examples for the use of distinguished name:

- SubjectName.CN=verisign authority
- IssueName.C=DE
- Parent.Parent.SubjectName.O=Bosch Security Systems

Certificate chain

Select the checkbox to include the certificate chain.

Note: If the Management Server has exactly the same certificate installed, you don't necessarily have to include the certificate chain.

Number of included certificates

Type the exact number of certificates that are included in the access token.

Note: You must not include the Root certificate.

Access token lifetime

Type the time in hours to define how long the tokens are valid after they have been created by the Enterprise Management Server.

Refer to

- *Token-based authentication, page 88*

12.24

Trusted certificate settings dialog box (Settings menu)

Main window > **Settings** menu > **Trusted certificate settings...** command

This dialog allows you to introduce the certificate thumbprint that is used by the Management Server to authenticate the access token.

Note: The **Trusted certificate settings...** menu is only available if you start the Configuration Client with admin permissions and if the user who logs in has the **Configure User Groups/Enterprise Accounts** permission.

Thumbprint of trusted certificate

Displays an already configured thumbprint or an empty thumbprint in case no configuration can be found in the registry. Type or change the root certificate thumbprint.

The provided thumbprint is written to the path `HKEY_LOCAL_MACHINE\SOFTWARE\Bosch Sicherheitssysteme GmbH\Bosch Video Management System\TrustedCertificates` to the key "BvmsTrustedCertificate".

Note: The thumbprint is not included in the export when the configuration is exported.

Note: BVMS does not support certificates that use a Secure Hash Algorithm SHA-1 and have a key length smaller than 2048 bits.

12.25

Options dialog box (Settings menu)

Note: Some features require purchasing the respective license.

Main window > **Settings** menu > **Options...** command

Configuration Client

Language

Allows you to configure the language of your Configuration Client. If you select **System Language** the language of your Windows installation is used.

This setting is enabled after restarting Configuration Client.

Automatic logoff

Allows you to configure the automatic logoff of Configuration Client. Configuration Client will log off after the configured time period.

Changes in the configuration pages of the following devices in the **Devices** page are not saved automatically and are lost after inactivity logoff:

- Encoders
- Decoders
- VRM devices
- iSCSI devices
- VSG devices

All other pending configuration changes are saved automatically.

Note: Changes in dialog boxes that were not confirmed by clicking **OK**, are not saved.

Scan options

Allows you to configure if it is possible to scan for devices in the respective subnet or across the subnet.

Operator Client

Multiple logon

Allow multiple logon with the same user

Allows you to configure that a user of BVMS SDK, BVMS Web Client, BVMS Mobile App, or Operator Client can perform multiple synchronous logons with the same user name.

Server settings

Database connection string

Allows you to configure the connection string for the Logbook database.



Notice!

Change this string only when you want to configure a remote SQL server for the Logbook and only when you are familiar with SQL server technology.

Retention period

Allows you to define a maximum retention time of the entries within the logbook. After this defined retention time the entries are automatically deleted.

This setting is enabled after activating the configuration.

Devices

Monitor Group

Allows you to configure that the users can control all monitor groups with each BVMS client computer. It is then not required to configure this computer as a workstation in the Device Tree.

Decoder stream selection

Allows you to configure that all decoders in your system use a compatible stream and not necessarily the live stream.

This setting is enabled after activating the configuration.

Timeserver for encoder

Allows you to configure the time server settings for encoders. By default the Central-Server IP address is used.

System features**Maps****Type of background map**

Allows you to select the type of background map for the global map. The following map types are available if you have access to the internet (online mode):

- **HERE street map**
- **HERE dark street map**
- **HERE satellite map**

If you do not have access to the internet (offline mode), select **None**.

Customer specific API key

Enter your API key for using the online (Here) maps.

Display API key

Select the check box to display the API key.

**Notice!**

If you switch the type of background map from online (Here maps) to offline (**None**) or the other way around you lose all positioned camera hotspots and map viewports. You can define only one background for the global map. This background applies to all map viewports.

Map-based tracking assistant**Enable system feature**

Allows you to configure that a user of the Operator Client can use the Map-based tracking assistant.

Advanced state display**Disable hot spot coloring in maps**

Allows you to configure disabling blinking hotspots in maps.

Enabled advanced state display (hot spot coloring in maps depending on state)

Allows you to configure for all state events that the hotspots of the devices belonging to this event, are displayed with a background color and blink when the configured event occurs.

Enable advanced alarm display (hot spot coloring in maps depending on alarm)

Allows you to configure for all alarms that the hotspots of the devices belonging to this alarm, are displayed with a background color and blink when the configured alarm occurs. The configuration of the advanced state display is possible after you saved the configuration. The hotspots are displayed on a map in Operator Client after you have activated the configuration.

Export with Privacy overlay**Enable system feature**

Allows you to configure that a user of the Operator Client can export video with Privacy overlay.

13 Devices page

Main window > **Devices**



Notice!

BVMS Viewer does not support decoder devices.

Displays the Device Tree and the configuration pages.

The count of items below an entry is displayed in square brackets.

Allows you to configure the available devices, such as mobile video services, ONVIF encoders, Bosch Video Streaming Gateway devices, encoders, decoders, VRMs, local storage encoders, analog matrices, or peripheral devices like ATM/POS Bridge.

Note:

Devices are represented in a tree and grouped by the physical network structure and the device categories.

Video sources like encoders are grouped under VRMs.

To search for items:

- ▶ In the search field type a string and press the ENTER key to filter the displayed items.
Only items containing the string and their corresponding parent items (only in trees) are displayed. The count of filtered items and the total count of items is provided.

Note: Enclose strings with double quotes to find them exactly, for example "Camera 1" exactly filters the cameras with this name, not camera 201.

- ▶ Click a tree item to display the corresponding page.

13.1 Updating device states and capabilities

Main window > **Devices**

For example after a firmware update it can be necessary to synchronize the capabilities of all configured decoders, encoders and VSGs. With this function the capabilities from each device are compared to the capabilities already stored within BVMS. You can update the device capabilities of all devices in the device tree at once.

It is also possible to copy a list of the devices whose capabilities changed into the clipboard. You can then paste the list, for example, into a text editor to examine the changes in detail.

The device list from the clipboard is formatted as CSV and contains the following information:

- Device
- Device type
- IP address

Note: When you have a large system with several 1000 devices configured, the process of refreshing device states and updating device capabilities can take a long time.



Notice!

The capabilities are only retrieved for reachable devices. To see, if a device is not reachable, you have to check the state of the device.

To update the device states and capabilities:

1. Click .

The **Update device capabilities** dialog box is displayed. The state information of all devices is updated and the device capabilities are retrieved.

Only if device capabilities are not up to date, the appropriate devices are displayed in a list and the **Update** button is enabled.
 2. If required, click **Copy device list to clipboard**.
 3. Click **Update**.
 4. Click **OK**.
- ⇒ The device capabilities are now updated.

**Notice!**

The state information of all devices will always be updated, even if you cancel the **Update device capabilities** dialog.

13.2**Changing the password for IP devices**

Main window > **Devices** >  **Change device passwords** > **Change device passwords** dialog box

or

Main window > **Hardware** menu > **Change device passwords...** command > **Change device passwords** dialog box

To change the password for IP devices:

1. Select the required device.
2. Right-click the selected device and click **Edit password...**

The **Change device passwords** dialog box is displayed.
3. Select the required password type.
4. Type in the new password.
5. Click **OK**.

The new password is updated in the selected device.

See *Change device passwords dialog box (Hardware menu)*, page 106 for details.

To change the settings for multiple devices:

See *Configuring multiple encoders / decoders*, page 220.

Refer to

- *Change device passwords dialog box (Hardware menu)*, page 106

13.3**Adding a device**

Main window > **Devices**

You add the following devices to the Device Tree manually, that means you must know the network address of the device to add it:

- Video IP device from Bosch
- Analog matrix

For adding a Bosch Allegiant device, you need a valid Allegiant configuration file.
- BVMS workstation

A workstation must have the Operator Client software installed.
- Communication device

- Bosch ATM/POS Bridge, DTP device
- Virtual input
- Network monitoring device
- Bosch IntuiKey keyboard
- KBD-Universal XF keyboard
- Monitor group
- I/O module
- Allegiant CCL emulation
- Intrusion panel from Bosch
- Server-based analytics device
- Access control systems from Bosch

You can scan for the following devices to add them with the help of the **BVMS Scan Wizard** dialog box:

- VRM devices
- Encoders
- Live only encoders
- Live only ONVIF encoders
- Local storage encoders
- Decoders
- Video Streaming Gateway (VSG) devices
- DVR devices



Notice!



After having added a device, click  to save the settings.





Notice!

Add the DVR using the administrator account of the device. Using a DVR user account with restricted permissions can result in features that are not usable in BVMS, for example using the control of a PTZ camera.



BVMS Scan Wizard dialog box

Main window > **Devices** > Expand  > Right-click  > Click **Scan for Encoders** > **BVMS Scan Wizard** dialog box

Main window > **Devices** > Expand  > Right-click  > Click **Scan for Video Streaming Gateways** > **BVMS Scan Wizard** dialog box

Main window > **Devices** > Right-click  > Click **Scan for Live Only Encoders** > **BVMS Scan Wizard** dialog box

Main window > **Devices** > Right-click  > Click **Scan for Local Storage Encoders** > **BVMS Scan Wizard** dialog box

Main window > **Devices** > Expand  > Expand  > Right-click  > Click **Scan for decoders** > **BVMS Scan Wizard** dialog box

This dialog box allows you to scan for available devices in your network, configure them and add them to your system in one process.

Use

Click to select a device for adding to the system.

Type (not available for VSG devices)

Displays the type of the device.

Display Name

Displays the device name that was entered in the Device Tree.

Network Address

Displays the IP address of the device.

User Name

Displays the user name that is configured on the device.

Password

Type in the password for authenticating with this device.

Status

Displays the status of authentication.



: Succeeded



: Failed

Main window > **Devices** > Right-click  > Click **Scan for VRM Devices** > BVMS Scan Wizard dialog box



Notice!

For configuring a Secondary VRM you must first install the appropriate software on the desired computer. Run Setup.exe and select **Secondary VRM**.

Role

In the list, select the desired entry.

The following table lists which roles each VRM type can have:

Role / Type	Primary VRM	Secondary VRM
Primary (Normal)	X	
Secondary (Normal)		X
Primary Failover	X	
Secondary Failover		X
Mirrored		X

To a Primary VRM you can add a VRM device with the following roles:

- Failover VRM
- Mirrored VRM

To a Secondary VRM you can add VRM devices with the following role:

- Failover VRM

Master VRM

In the list, select the desired entry.

User Name

Displays the user name that is configured on the VRM device.

You can type in another user name if required.

Refer to

- *Adding VRM Devices via scan, page 166*
- *Adding an encoder to a VRM pool, page 210*
- *Adding a live only encoder, page 211*
- *Adding a local storage encoder, page 211*
- *Scanning for devices, page 75*

13.4

Server list / Address Book page

Main window > **Devices** > **Enterprise System** > **Server List / Address Book**

You can add multiple Management Server computers for simultaneous access in BVMS Enterprise System. You can also add multiple Management Server computers for sequential access for Server Lookup.

You can add additional columns in the Server List. This lets you add further information that the user can search for when using Server Lookup. The added columns are also visible on the

Server access page (Main window > **User groups** > **Enterprise User Groups** tab >  > **Server access** tab).

Add Server

Click to display the **Add Server** dialog box.

Delete Server

Click to remove the Management Server entries.

Management Server

Displays the names of all added Management Server computers. You can change each entry.

Note: If you use a SSH connection, enter the address in the following format:

ssh://IP or servername:5322

Private Network Address

Displays the private network addresses of all added Management Server computers. You can change each entry.

Server Number

Displays the logical numbers of all added Management Server computers. You can change each entry.

Server Description

Type in a description for this Management Server. You need this description to find it in the list of all available servers when you want to access the Management Server exclusively, for example to clarify an alarm coming from another management system.

Click to get a step-by-step instruction:

- *Configuring the Server List for Enterprise System, page 86*
- *Configuring Server Lookup, page 127*

- *Exporting the Server List, page 128*
- *Importing a Server List, page 128*

Refer to

- *SSH Tunneling, page 50*

13.4.1**Add Server dialog box**

Main window > **Devices** > **Enterprise System** > **Server List / Address Book**

Server name

Type in the display name of the Management Server.

Note: If you use a SSH connection, enter the address in the following format:

ssh://IP or servername:5322

Private Network Address

Type in the private IP address or DNS name of the Management Server.

Public Network Address

Type in the public network address.

Server description

Type in a description for the Management Server.

13.4.2**Configuring Server Lookup**

For Server Lookup, the user of Operator Client or Configuration Client logs on with a user name of a normal user group, not as a user of an Enterprise User Group.

Refer to

- *Server Lookup, page 24*
- *Server list / Address Book page, page 126*
- *Using Server Lookup, page 75*

13.4.3**Configuring the Server List**

Main window > **Devices** > **Enterprise System** > **Server List / Address Book**

To add servers:

1. Click **Add Server**.
The **Add Server** dialog box is displayed.
2. Type in a display name for the server and type in the private network address (DNS name or IP address).
Note: If you use a SSH connection, enter the address in the following format:
ssh://IP or servername:5322
3. Click **OK**.
4. Repeat these steps until you have added all desired Management Server computers.

To add columns:

- ▶ Right-click on the table header and click **Add column**.
You can add up to 10 columns.
To delete a column, right-click the desired column and click **Delete column**.
- ⇒ When you export the Server List, the added columns are also exported.

Refer to

- *Configuring the Server List for Enterprise System, page 86*

13.4.4 Exporting the Server List

Main window > **Devices** > **Enterprise System** > **Server List / Address Book**

You can export the Server List with all configured properties for editing and later import.

When you edit the exported csv file in an external editor, note the limitations described in the Server List chapter.

To export:

1. Right-click on the table header and click **Export Server List....**
 2. Type in a name for the export file and click **Save**.
- ⇒ All columns of the Server List are exported as a csv file.

Related Topics

- *Server Lookup, page 24*
- Server List
- *Server list / Address Book page, page 126*

13.4.5 Importing a Server List

Main window > **Devices** > **Enterprise System** > **Server List / Address Book**

When you have edited the exported csv file in an external editor, note the limitations described in the Server List chapter.

To import:

1. Right-click on the table header and click **Import Server List....**
2. Click the desired file and click **Open**.

Related Topics

- *Server Lookup, page 24*
- Server List
- *Server list / Address Book page, page 126*

13.5 DVR (Digital Video Recorder) page

Main window > **Devices** >  > 

Displays the property pages of a selected DVR.

Allows you to integrate a DVR into your system.

- ▶ Click a tab to display the corresponding property page.



Notice!

You do not configure the DVR itself but only the integration of the DVR device into BVMS.



Notice!

Add the DVR using the administrator account of the device. Using a DVR user account with restricted permissions can result in features that are not usable in BVMS, for example using the control of a PTZ camera.

Refer to

- *DVR devices, page 128*
- *Configuring the integration of a DVR, page 131*

13.5.1 DVR devices

This chapter gives background information on the DVR devices that you can integrate in BVMS.

Some DVR models (e.g. DHR-700) support recording from encoders / IP cameras. Other DVR models support only analog cameras.

An encoder / IP camera should not be integrated into the configuration of two video systems (DVRs or video management systems).

If encoders / IP cameras are connected to a DVR which is already integrated in BVMS, these encoders / IP cameras are not detected by the BVMS network device scan. This holds true for the network scan started from within Configuration Client or started from within Config Wizard.

If a DVR with connected encoders / IP cameras is integrated in BVMS and these encoders / IP cameras are already added to BVMS, a warning is displayed. Remove these encoders / IP cameras from the DVR or from BVMS.

Config Wizard does not add DVR devices with conflicting IP cameras to the configuration. DVR devices support a limited number of simultaneous connections. This number defines the maximum number of Operator Client users that can simultaneously display videos from this DVR without black Image panes being displayed.



Notice!

Add the DVR using the administrator account of the device. Using a DVR user account with restricted permissions can result in features that are not usable in BVMS, for example using the control of a PTZ camera.



Notice!

DIVAR AN 3000/5000: When you delete video data from the DVR, please note that you always delete at least the full hour of video data. For example if you select a time period from 6:50 to 7:05, you will effectively delete the video data from 6:00 through 8:00.

Bosch 700 Series Hybrid and Network HD Recorders: Deletion always starts with the beginning of the recordings of all cameras that are displayed in Operator Client, and ends with the point in time that you enter.

Refer to

- *DVR (Digital Video Recorder) page, page 128*
- *Configuring the integration of a DVR, page 131*

13.5.2

Adding a DVR device via scan

To add DVR devices via scan:

1. Right-click  and click **Scan for DVRs**.
The **BVMS Scan Wizard** dialog box is displayed.
2. Select the desired check boxes for the devices that you want to add.
3. Click **Next >>**.
The **Authenticate Devices** dialog box of the wizard is displayed.
4. Type in the password for each device that is protected by a password.
Password check is performed automatically, when you do not enter a further character in the password field for a few seconds or you click outside the password field.
If the passwords of all devices are identical, you can enter it in the first **Password** field.

Then right-click this field and click **Copy cell to column**.



In the **Status** column, the successful logons are indicated with



The failed logons are indicated with

5. Click **Finish**.

The device is added to the Device Tree.

13.5.3 Add DVR dialog box

Main window > **Devices** > Expand  >  > **Add DVR**

Allows you to manually add a DVR device.

Network address / port

Type the IP address of your DVR. If required, change the port number.

User name:

Type the user name for connecting to the DVR.

Password:

Type the password for connecting to the DVR.

Security

The **Secure connection** check box is selected by default.

If a secure connection is not possible, a message appears. Click to remove the checkmark.



Notice!

If the **Secure connection** check box is selected, command and control connections are secure. Video data streaming is not secure.

Refer to

- *Adding a device, page 123*

13.5.4 Settings tab

Main window > **Devices** >  >  > **Settings tab**

Displays the network settings of the DVR connected to your system. Allows you to change the settings if required.

13.5.5 Cameras tab

Main window > **Devices** >  >  > **Cameras tab**

Displays all video channels of the DVR as cameras. Allows you to remove cameras.

A video input that is disabled in a DVR device is displayed as an active camera in BVMS because earlier recordings could exist for this input.

13.5.6 Inputs tab

Main window > **Devices** >  >  > **Inputs tab**

Displays all inputs of the DVR.

Allows you to remove items.

13.5.7 Relays tab

Main window > **Devices** >  >  > **Relays** tab
Displays all relays of the DVR. Allows you to remove items.

13.5.8 Configuring the integration of a DVR

Main window > **Devices** > Expand  > 



Notice!

Add the DVR using the administrator account of the device. Using a DVR user account with restricted permissions can result in features that are not usable in BVMS, for example using the control of a PTZ camera.



Notice!

You do not configure the DVR itself but only the integration of the DVR device into BVMS.

To remove an item:

1. Click the **Settings** tab, the **Cameras** tab, the **Inputs** tab, or the **Relays** tab.
2. Right-click an item and click **Remove**. The item is removed.



Notice!

To restore a removed item, right-click the DVR device and click **Rescan DVR**.



To rename a DVR device:

1. Right-click a DVR device and click **Rename**.
2. Type the new name for the item.

Refer to

- *Adding a device, page 123*
- *DVR (Digital Video Recorder) page, page 128*

13.6 Matrix Switches page

Main window > **Devices** >  > 
Displays the property pages of the Bosch Allegiant device.
You do not configure the Bosch Allegiant device itself but only the BVMS related properties.
For connecting an Allegiant device with BVMS, see the **Concepts** chapter in this Online Help.
This chapter provides background information on selected issues.
You can additionally configure control priorities for Allegiant trunk lines.

- ▶ Click a tab to display the corresponding property page.

Refer to

- *Configuring a Bosch Allegiant device, page 132*
- *Connecting Bosch Allegiant Matrix to BVMS, page 56*

13.6.1 Adding a Bosch Allegiant device

To add a Bosch Allegiant device:

1. Right-click  and click **Add Allegiant**.
The **Open** dialog box is displayed.
2. Select the appropriate Allegiant configuration file and click **OK**.
The Bosch Allegiant device is added to your system.

Note: You can add only one Bosch Allegiant matrix.

13.6.2 Configuring a Bosch Allegiant device

Main window > **Devices** > Expand  > 

You do not configure the Bosch Allegiant device itself but only the BVMS related properties.

To assign an output to an encoder:

1. Click the **Outputs** tab.
2. In the **Usage** column, click **Digital Trunk** in the desired cells.
3. In the **Encoder** column, select the desired encoder.

Adding an input to a Bosch Allegiant device:

1. Click the **Inputs** tab.
2. Click **Add Inputs**. A new row is added to table.
3. Type the required settings in the cells.

Deleting an input:

1. Click the **Inputs** tab.
2. Click the required table row.
3. Click **Delete Input**. The row is deleted from the table.

Refer to

- *Connecting a Bosch IntuiKey keyboard to BVMS, page 52*
- *Connection page, page 133*
- *Cameras page, page 134*
- *Outputs page, page 132*
- *Inputs page, page 133*

13.6.3 Outputs page

Main window > **Devices** > Expand  >  > **Outputs** tab

Allows you to configure the usage of a Bosch Allegiant device output and to assign an encoder to an output.

To store the video data of a Bosch Allegiant device output in BVMS, you must assign an encoder to the output. This encoder must be connected to the output.

No.

Displays the number of the output.

Allegiant Logical No.

Displays the logical number of the output within Allegiant.

BVMS Logical No.

Allows you to change the logical number of the output within BVMS. If you enter an already used number, a message is displayed.

Name

Displays the name of the output.

Usage

Allows you to change the usage of the output.

If you select **Digital Trunk**, you can assign an encoder to this output in the **Encoder** field. The Allegiant output becomes network-compatible.

If you select **Allegiant Monitor**, in Operator Client the user can assign the camera signal to a hardware monitor. PTZ control is possible if the camera is configured as PTZ camera. In Operator Client, the user cannot drag this camera on an Image pane.

If you select **Unused**, the user cannot assign a monitor to an Allegiant camera.



Encoder

Allows you to assign an output to an encoder. You can only select an encoder when you have checked **Digital Trunk**. The encoder is locked for the Logical Tree. If you assign an encoder that is already in the Logical Tree, it is removed from there. In the Operator Client, the user can drag the camera to an Image pane.

Refer to

– *Configuring a Bosch Allegiant device, page 132*

13.6.4**Inputs page**

Main window > **Devices** > Expand  >  > **Inputs** tab
Allows you to add inputs to a Bosch Allegiant device.

Add Input

Click to add a new row in the table for specifying a new input.

Delete Input

Click to remove a row from the table.

Input No.

Type the required number of the input. If you enter an already used number, a message is displayed.



Input Name

Type the required name of the input.

Refer to

– *Configuring a Bosch Allegiant device, page 132*

13.6.5**Connection page**

Main window > **Devices** > Expand  >  > **Connection** tab
Displays the name of the Bosch Allegiant configuration file.

BVMS can read out a configuration file in structured storage format with the names and configuration information of all cameras connected to the Bosch Allegiant device.



Update Configuration

Click to select an updated Bosch Allegiant configuration file.

Refer to

– *Configuring a Bosch Allegiant device, page 132*

13.6.6 Cameras page

Main window > **Devices** > Expand  >  > **Cameras** tab
Displays a camera table of the cameras that are connected to the Bosch Allegiant device.

No.

Displays the consecutive number of the camera.

Allegiant Logical No.

Displays the logical number of the camera.

Camera Name

Displays the name of the camera.

Refer to

- *Configuring a Bosch Allegiant device, page 132*

13.7 Workstation page

Main window > **Devices** > Expand  > 
A workstation must have the Operator Client software installed.

Allows you to configure the following settings for a workstation:

- Add a CCTV keyboard connected to a Bosch Video Management System workstation.
- Assign a Command Script that is executed on startup of the workstation.
- Select the default stream for live display. You can select streams for dual stream cameras and for multi stream cameras.
- Enable Forensic Search.

Note: You can not configure a CCTV keyboard for a default workstation. This is only possible for specific configured workstations.

To add a Bosch IntuiKey keyboard that is connected to a decoder, expand , click .

Refer to

- *Adding a workstation manually, page 134*
- *Configuring a startup Command Script (settings page), page 135*

13.7.1 Adding a workstation manually

To add a BVMS workstation:

1. Right-click 
2. Click **Add Workstation**.
The **Add Workstation** dialog box is displayed.
3. Enter the appropriate value.
4. Click **OK**.

The workstation  is added to your system.

To add a BVMS default workstation:

- ▶ Right-click 

Click **Add Default Workstation**.

The workstation  is added to your system.



Notice!

You can only add one single default workstation.

If a default workstation is configured, the settings apply for each workstation that is connected to this server and is not configured separately.

If a workstation is configured, the settings for this specific workstation apply and not the default workstation settings.

13.7.2 Configuring a Bosch IntuiKey keyboard (settings page) (workstation)

Main window > **Devices**> Expand  > 

To configure a Bosch IntuiKey keyboard connected to a workstation:

1. Click the **Settings** tab.
2. In the **Keyboard Settings** field, make the required settings.

For detailed information on the various fields, see the Online Help for the appropriate application window.

Refer to

- *Workstation page, page 134*

13.7.3 Enabling Forensic Search on a workstation (settings page)

Main window > **Devices** > Expand  >  > **Settings** page

You must enable Forensic Search on a workstation.

Note:

Enable video content analysis on each encoder. Use the VCA page of the encoder in the Device Tree.

To enable Forensic Search:

- ▶ Click to select the check box.

13.7.4 Configuring a startup Command Script (settings page)

Main window > **Devices** > Expand  >  > **Settings** page

You configure a Command Script to be started when the Operator Client on the selected workstation is started.

You must create a corresponding Command Script.

For creating a Command Script, see *Managing Command Scripts, page 90*.

To configure a startup script:

- ▶ In the **Startup script:** list, select the required Command Script.

Refer to

- *Workstation page, page 134*

13.7.5 Settings page



Main window > **Devices** > Expand

Allows you to configure a script that is executed when the Operator Client on the workstation is started.

Allows you to configure TCP or UDP as transmission protocol used for all cameras that are displayed in Live Mode on your workstation.

Allows you to configure which stream of an IP device is used for live display.

Allows you to enable Forensic Search for this workstation.

And you can configure the keyboard that is connected to this workstation.

Network address:

Type the DNS name or the IP address of your workstation.

Startup script:

Select the desired script that you want to be started when the workstation's Operator Client is started. You create or import such a script on the **Events** page.

Default camera protocol:

Select the default transmission protocol used for all cameras that are assigned to the Logical Tree of this workstation.

Override settings from "Cameras and Recording" page

Select the check box to enable selecting the desired stream for live view.

Note: For DVR devices which offer more than 1 stream (for example DIVAR AN 3000/5000), the Live stream setting from this DVR is also changed here. Live stream settings for DVR devices are not available on the **Cameras and recording** page.

Live Stream

Select the desired stream for live view. You can select streams for dual stream cameras and for multi stream cameras.

When you select **Image pane size optimized**, the resolution of each displayed camera is automatically adjusted to the size of the Image pane depending on the resolution of the used monitor. This is useful for displaying multiple cameras with a large resolution, for example 4K ultra HD cameras. Only cameras with streams whose resolution can be configured independently, can adjust the resolution to the Image pane. The user of Operator Client can change the stream selection for each camera individually.

Dual stream cameras

Select the default stream for live display for dual stream cameras.

Multi stream cameras

Select the default stream for live display for multi stream cameras.

Use transcoded stream instead, if available

Select the check box to enable the usage of a transcoded stream if available. This transcoded stream is used instead of the selected stream for live view.

For a transcoded stream being available in BVMS, either MVS must be installed or your VRM computer offers a built-in hardware transcoder.

When a camera is displayed in Live Mode then the default stream set for the workstation is used. If the camera has no stream 2 or the transcoding service (SW and HW) is not available then stream 1 will be used even though another setting is configured in the workstation settings.

Use direct playback from storage

Select the check box to send the video stream directly from the storage device to this workstation. Now the stream is not sent via VRM. The workstation still needs connection to the VRM to ensure correct playback.

Note: You can only use the direct playback from the iSCSI storage device if you have set the global iSCSI CHAP password.

Retrieve live video from Video Streaming Gateway instead of camera

Displays the list of Video Streaming Gateway devices. Select the desired entries to enable the transmission of video data via low bandwidth segments between the video source and this workstation.

Note: If you select a Video Streaming Gateway device for retrieving live video, the **Live Video - Profile** on the **Cameras and recording** page is obsolete. Instead, the **Recording - Profile** setting is also used for live video.

Keyboard type:

Select the type of the keyboard that is connected to your workstation.

Port:

Select the COM port that is used to connect your keyboard.

Baudrate:

Select the maximum rate, in bits per second (bps), that you want data to be transmitted through this port. Usually, this is set to the maximum rate supported by the computer or device you are communicating with.

Data bits:

Displays the number of data bits you want to use for each character that is transmitted and received.

Stop bits:

Displays the time between each character being transmitted (where time is measured in bits).

Parity:

Displays the type of error checking you want to use for the selected port.

Port type:

Displays the connection type that is used to connect the Bosch IntuiKey keyboard with the workstation.

Refer to

- *Configuring a startup Command Script (settings page), page 135*
- *Enabling Forensic Search on a workstation (settings page), page 135*

13.7.6**Changing the network address of a workstation**

Main window > **Devices** > Expand 

To change the IP address:

1. Right-click  and click **Change Network Address**.
The **Change Network Address** dialog box is displayed.
2. Change the entry in the field according to your requirements.

13.8**Decoders page**

Main window > **Devices** > Expand   >

Allows you to add and configure decoders.



Notice!

BVMS Viewer does not support decoder devices.



Notice!

If you want to use decoders in your system, make sure that all encoders use the same password for the user authorization level.

Refer to

- *Scanning for devices, page 75*
- *Bosch Encoder / Decoder / Camera page, page 209*

13.8.1

Adding an Encoder / Decoder manually

Main window > **Devices** > Expand  > Expand  > Right-click  > Click **Add Encoder** > **Add Encoder** dialog box

or

Main window > **Devices** > Right-click  > Click **Add Encoder** > **Add Encoder** dialog box

or

Main window > **Devices** > Right-click  > Click **Add Encoder** > **Add Encoder** dialog box

or

Main window > **Devices** > Expand  > Right-click  > Click **Add Decoder** > **Add Encoder** dialog box

Allows you to add an encoder or decoder manually. This is especially useful when you want to add any Video IP device from Bosch (only for VRM).

Notice:

If you add a Video IP encoder or decoder from Bosch with the **<Auto Detect>** selection, this device must be available in the network.

To add a Video IP device from Bosch:

1. Expand , expand , right-click .
- Or

Right-click .

Or

Right-click .

2. Click **Add Encoder**.
The **Add Encoder** dialog box is displayed.
3. Enter the appropriate IP address.
4. In the list, select **<Auto Detect>**.

- 5. Click **OK**.
The device is added to the system.

The  icon indicates an error that you need to take care of. Check the tool tip for more information about the specific error.

Add Encoder dialog box

IP address:

Type in a valid IP address.

Encoder type: / Decoder type:





For a device with known device type, select the appropriate entry. It is not necessary that the device is available in the network.

If you want to add any Video IP device from Bosch, select **<Auto Detect>**. The device must be available in the network.



If you want to add a camera for offline configuration, select **<Single placeholder camera>**.

13.8.2

Edit Encoder / Edit Decoder dialog box

Main window > **Devices** > Expand  > Expand  > Expand  > Right-click  > Click **Edit Encoder** > **Edit Encoder** dialog box
or

Main window > **Devices** > Expand  > Right-click  > Click **Edit Encoder** > **Edit Encoder** dialog box
or

Main window > **Devices** > Expand  > Right-click  > Click **Edit Encoder** > **Edit Encoder** dialog box
or

Main window > **Devices** > Expand  > Expand  > Right-click  > Click **Edit Decoder** > **Edit Decoder** dialog box

Allows you to check and update the device capabilities of a device. On opening this dialog box the device is connected. The password is checked and the device capabilities of this device are compared with the device capabilities stored in BVMS.

Name

Displays the device name. When you add a Video IP device from Bosch, the device name is generated. If required change the entry.

Network address / port

Type the network address of the device. If required, change the port number.

User name

Displays the user name used for authenticating at the device.

Password

Type the valid password for authenticating at the device.

Show password

Click to enable that the entered password is displayed. Be careful that nobody can spy out this password.

Authenticate

Click to authenticate at the device with the credentials entered above.

Security

The **Secure connection** check box is selected by default.

If a secure connection is not possible, a message appears. Click to remove the checkmark.

The following decoders support secure connection:

- VJD 7000
- VJD 8000
- VIP XD HD



Notice!

The connection between a decoder and an encoder is only secure, if both are configured with secure connection.

Video stream

UDP: Enables encrypted multicast streaming for supported decoder devices.

TCP: Enables encrypted unicast streaming for supported decoder devices.

Note: If no multicast address is configured for an encoder, the decoder retrieves the stream by unicast.



Notice!

BVMS does not support Bosch cameras connected to a VSG.

BVMS only supports UDP encryption for platforms older than CPP13.

Device Capabilities

You can sort the displayed device capabilities per category or alphabetically.

A message text informs you whether the detected device capabilities match the current device capabilities.





Click **OK** to apply the changes of the device capabilities after an upgrade of the device.

Refer to

- *Encrypting live video (Edit Encoder), page 211*
- *Updating the device capabilities (Edit Encoder), page 212*

13.8.3

Changing the password of an encoder / decoder (Change password / Enter password)

Main window > **Devices** > Expand  > Expand  >  > 



or

Main window > **Devices** >  > 

or

Main window > **Devices** >  > 

or

Main window > **Devices** > Expand  > Expand  > 

Define and change a separate password for each level. Enter the password (19 characters maximum; no special characters) for the selected level.

To change the password:

1. Right-click  and click **Change password...**
The **Enter password** dialog box is displayed.
 2. In the **Enter user name** list, select the desired user for which you want to change the password.
 3. In the **Enter password for user** field, type in the new password.
 4. Click **OK**.
- ⇒ The password is changed immediately on the device.

A password prevents unauthorized access to the device. You can use different authorization levels to limit access.

Proper password protection is only guaranteed when all higher authorization levels are also protected with a password. Therefore, you must always start from the highest authorization level when assigning passwords.

You can define and change a password for each authorization level if you are logged into the “service” user account.

The device has three authorization levels: service, user, and live.

- service is the highest authorization level. Entering the correct password gives access to all the functions and allows all configuration settings to be changed.
- user is the middle authorization level. At this level you can operate the device, play back recordings, and also control camera, for example, but you cannot change the configuration.
- live is the lowest authorization level. At this level you can only view the live video image and switch between the different live image displays.

For a decoder the following authorization level replaces the live authorization level:

- destination password (only available for decoders)
Used for access to an encoder.

Refer to

- *Providing the destination password for a decoder (Authenticate...), page 204*

13.8.4**Decoder profile**

Allows you to set the various options for the display of video images on a VGA monitor.

Monitor name

Type the name of the monitor. The monitor name facilitates the identification of the remote monitor location. Use a name that makes it as easy as possible to identify the location.

Click  to update the name in the Device Tree.

Standard

Select the video output signal of the monitor you are using. Eight pre-configured settings for the VGA monitors are available in addition to the PAL and NTSC options for analog video monitors.

**Notice!**

Selecting a VGA setting with values outside the technical specification of the monitor can result in severe damage to the monitor. Refer to the technical documentation of the monitor you are using.

Window layout

Select the default image layout for the monitor.

VGA screen size

Type the aspect ratio of the screen (for example 4 x 3) or the physical size of the screen in millimeters. The device uses this information to accurately scale the video image for distortion-free display.

13.8.5**Monitor display**

The device recognizes transmission interruptions and displays a warning on the monitor.

Display transmission disturbance

Select **On** to display a warning in case of transmission interruption.

Disturbance sensitivity

Move the slider to adjust the level of the interruption that triggers the warning.

Disturbance notification text

Type the text of the warning the monitor displays when connection is lost. The maximum text length is 31 characters.

13.8.6**Configuring a Bosch IntuiKey keyboard (decoder)**

Main window > **Devices**> Expand

**Notice!**

You cannot connect a KBD-Universal XF keyboard to a decoder.

To configure a Bosch IntuiKey keyboard connected to a decoder:

1. In the **Connection** column, click a cell, and select the appropriate decoder.
You can also select a workstation, if the Bosch IntuiKey keyboard is connected to it.



A workstation must be configured on the  page.

2. In the **Connection Settings** field, make the required settings.
For detailed information on the various fields, see the Online Help for the appropriate application window.

Refer to

- *Assign Keyboard page, page 152*
- *Scenarios for Bosch IntuiKey keyboard connections, page 52*
- *Connecting a Bosch IntuiKey keyboard to a decoder, page 54*

13.8.7**Configuring a decoder for use with a Bosch IntuiKey keyboard**

Main window > **Devices** > Expand



> Expand



Perform the following steps to configure a VIP XD decoder that is connected to a Bosch IntuiKey keyboard.

To configure a decoder:

1. Click the appropriate decoder which is used for connecting a Bosch IntuiKey keyboard.
2. Click the **Periphery** tab.
3. Ensure that the following settings are applied:
 - Serial port function: **Transparent**

- Baud rate: **19200**
- Stop bits: **1**
- Parity check: **None**
- Interface mode: **RS232**
- Half-duplex mode: **Off**

Refer to

- *Scenarios for Bosch IntuiKey keyboard connections, page 52*
- *Connecting a Bosch IntuiKey keyboard to a decoder, page 54*
- *Updating Bosch IntuiKey keyboard firmware, page 55*



13.8.8

Delete decoder logo

Click to delete the logo that has been configured on the Web page of the decoder.

13.9

Monitor groups page

Main window > **Devices** > Expand  >  > Click **Add monitor group**

Allows you to add and configure monitor groups. You assign a monitor group to a BVMS workstation in .



Notice!



You cannot control a monitor group from within Operator Client when the connection to the Management Server is lost.

Refer to

- *Adding a monitor group manually, page 143*
- *Configuring a monitor group, page 144*
- *Configuring predefined positions and auxiliary commands, page 284*
- *Configuring an alarm, page 306*
- *Alarm Options dialog box, page 297*
- *Select Image Pane Content dialog box (MG), page 296*



13.9.1

Adding a monitor group manually

Main window > **Devices** > Expand  > Right-click  > Click **Add monitor group**

1. Click **Add monitor group**.
The **Add monitor group** dialog box is displayed. Type in the name for your new monitor group.
2. Click OK.
The monitor group is added to your system.
3. Click **Maps and structure**.
4. Drag the monitor group to the Logical Tree.

13.9.2 Configuring a monitor group

Main window > **Devices** > Expand  >  > 



Notice!

You cannot control a monitor group from within Operator Client when the connection to the Management Server is lost.

You configure the monitors in a monitor group logically in rows and columns. This arrangement does not have to meet the physical arrangement of the monitors.

To configure a monitor group:

1. Drag the appropriate monitors from the **Unassigned monitors** tab to the monitor groups field.
2. In the **Layout** tab, select the appropriate layout.
3. Drag any available camera from the **Cameras** tab to a monitor pane on the left. The logical number of the camera is displayed as a black number on the monitor pane and the color of this pane changes.
4. Change the logical numbers of the image panes as required. If you enter an already used number, a message box is displayed.
5. In the **Options** tab, you can select, if the camera name and number are visible in the monitor pane. You can also select the position of this information.

Monitor image

The black bold number, if present, displays the logical number of the initial camera. The black light number displays the logical number of the monitor.

To un-assign a camera, right-click the monitor pane and click **Clear monitor** or drag the camera outside the image pane.

Refer to

- *Adding a monitor group manually, page 143*

13.10 Communication Devices page

Main window > **Devices** > Expand  > 

Allows you to add or configure a communication device.

You can configure the following communication device:



- E-mail

Refer to

- *Configuring a communication device, page 145*

13.10.1 Adding an E-mail/SMTP Server

To add a communication device:

1. Expand , right-click  and click **Add E-mail/SMTP Device**. The **Add E-mail/SMTP Device** dialog box is displayed.
2. Enter the appropriate settings.

3. Click **OK**.
The communication device is added to your system.

Add E-mail/SMTP Device dialog box

Name:

Type the display name of the e-mail server.

13.10.2

SMTP Server page

Main window > **Devices** > Expand  > Expand  > 

Allows you to configure the e-mail settings of your system. On the **Events** page, you can assign an event to an e-mail. When this event occurs, the systems sends an e-mail. You cannot receive e-mails in BVMS.

SMTP server name

Type the name of the e-mail server. You get the information about the required entry from your provider. Usually this is the IP address or DNS name of your e-mail server.

Sender address

Type the email the email address which is used as the sender address when the system sends an email, for example in case of an alarm.

SSL/TLS

Select the check box to enable the usage of a secure SSL/TLS connection. In this case the network port switches automatically to 587.

Port

Type the required network port number for outgoing mails. You get the information about the required entry from your provider.

Port 25 is selected automatically when you disable the **SSL/TLS** setting.

You can select another port if required.

Connection time-out [s]

Type the number of seconds of inactivity until the connection is disconnected.

Authentication

Select a check box for the required authentication method. You get the information about the required entry from your provider.

User name

Type the user name for authenticating at the e-mail server. You get the information about the required entry from your provider.

Password:

Type the password for authenticating at the e-mail server. You get the information about the required entry from your provider.

Send Test E-mail

Click to display the **Send Test E-mail** dialog box.

Refer to

– *Configuring a communication device, page 145*

13.10.3

Configuring a communication device

Main window > **Devices** > Expand  > Expand 

To configure a communication device:



1. Click .
2. Make the appropriate settings.

For detailed information on the various fields, see the Online Help for the appropriate application window.

Refer to

- *Adding an E-mail/SMTP Server, page 144*
- *SMTP Server page, page 145*

13.10.4**Send Test E-mail dialog box**

Main window > **Devices** > Expand  > Expand  >  > **Send Test E-mail** button
Allows you to send a test e-mail.

From:

Type the e-mail address of the sender.

To

Type the e-mail address of the recipient.

Subject

Type the subject of the e-mail.

Message

Type the message.



Send Test E-mail

Click to send the e-Mail.

Refer to

- *Configuring a communication device, page 145*



13.11**ATM/POS page**

Main window > **Devices** > Expand  > 
Allows you to add and configure peripheral devices, for example, a Bosch ATM/POS Bridge.
If you want to add multiple bridges at one server, you must use different ports.



Refer to

- *Adding a Bosch ATM/POS bridge, page 98*
- *Configuring a peripheral device, page 147*

13.11.1**Adding a Bosch ATM/POS-Bridge manually**

Main window > **Devices** > Expand  > Right-click  > **Add Bosch ATM/POS-Bridge** .
Allows you to add a Bosch ATM.

To add a peripheral device:

1. Expand , right-click  and click **Add Bosch ATM/POS-Bridge**.
The **Add Bosch ATM/POS-Bridge** dialog box is displayed.
2. Enter the appropriate settings.

3. Click **OK**.
The peripheral device is added to your system.

Add Bosch ATM/POS-Bridge dialog box

Name:

Type an appropriate name for the device.

IP address:

Type the IP address of the device.

Port 1:

Type the appropriate port number used as the listening port of the ATM/POS Bridge.

Port 2:

Type the appropriate port number used as the listening port of the BVMS Management Server.



Notice!

When you add multiple ATM/POS Bridges to your system, ensure that the numbers for port 2 of each device deviate. Using the same number for port 2 multiple times can lead to ATM/POS data loss.

Refer to

- *Adding a Bosch ATM/POS bridge, page 98*

13.11.2

Bosch ATM/POS-Bridge page



Allows you to configure a Bosch ATM/POS Bridge.

IP address:

Type in the IP address of the device.

Port 1:

Type the appropriate port number used as the listening port of the ATM/POS Bridge.

Port 2:

Type the appropriate port number used as the listening port of the BVMS Management Server.



Notice!

When you add multiple ATM/POS Bridges to your system, ensure that the numbers for port 2 of each device deviate. Using the same number for port 2 multiple times can lead to ATM/POS data loss.





Refer to

- *Configuring a peripheral device, page 147*
- *Adding a Bosch ATM/POS bridge, page 98*

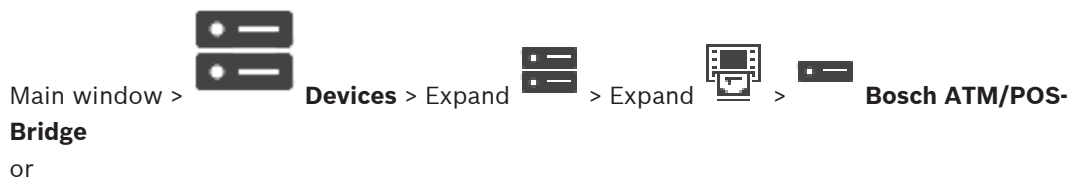
13.11.3

Configuring a peripheral device



Main window >  **Devices** > Expand  > Expand  > **DTP Device** > 

To configure a peripheral device:

- ▶ Change the required settings.

For detailed information on the various fields, follow the link to the appropriate application window below.

Refer to

- *ATM Settings page, page 148*
- *Bosch ATM/POS-Bridge page, page 147*
- *DTP Settings page, page 148*

13.11.4

DTP Settings page

Main window >  **Devices** > Expand  > Expand  > 

Allows you to configure a DTP device with maximum 4 ATM devices connected to this DTP device.

Serial port

In the list, select the appropriate port.

Refer to

- *ATM Settings page, page 148*
- *Configuring a peripheral device, page 147*

13.11.5

ATM Settings page

Main window >  **Devices** > Expand  > Expand  >  > 

Allows you to configure an ATM device that is connected to a DTP.

Input number of the DTP device

Select the desired input number. If the number is already used by another ATM device, you can swap the input numbers.

Connection timeout [hours]

Enter the desired number of hours. When during this time period the ATM device did not send any transaction data, BVMS assumes that the connection is disconnected. A corresponding event is triggered. The **Not Authenticated** event is available for an ATM device but not relevant.

Entering **0** means that no connection check is performed.



Data Inputs

Click to enable the desired inputs and type in a desired name for the inputs.

Refer to

- *Configuring a peripheral device, page 147*

13.11.6 Inputs page

Main window >  **Devices** > Expand  > Expand  > **Inputs** tab

Allows you to configure the inputs of a Bosch ATM/POS Bridge.

Refer to

- *Configuring a peripheral device, page 147*
- *Adding a Bosch ATM/POS bridge, page 98*

13.12 Foyer Card Readers

Main window > **Devices** > Expand  >  > **Global Settings for Foyer Card Readers** tab

You can configure the settings that are valid for all foyer card readers in your system.

Serial port

Select the serial port to which the foyer card reader is connected.

Locked Out

Allows you to add bank routing codes for locking out. This means that cards with the lock characteristics entered here do not have access authorization. Access is denied by the foyer card reader. The default mode of electric door lock release of the foyer card reader must be set to: **Automatic**

The list may contain entries with wildcards:

?: Indicates any or no character at this position.

*: Indicates a sequence (one or more characters) of any or no characters (exception: * on its own means that all bank sort codes are locked out).

Ignore country code on EC cards

Click to enable that BVMS does not analyze card data that is used to identify in which country the card was issued. Access is possible for cards with a different country code.

13.12.1 Add Foyer Card Reader dialog box

Main window > **Devices** > Expand  > Right-click  > **Add Foyer Card Reader** command

You can add a foyer card reader.



Name

Type in a name for the device.

Device identifier

Select a unique number for the device. If no numbers are available, the maximum number of foyer card readers have already been added to the system.

13.12.2 Settings for Foyer Card Reader page

Main window > **Devices** > Expand  >  >  > **Settings for Foyer Card Reader** tab

You can configure a foyer card reader.

Device identifier

Displays the unique number of the device.

Enable skimming protection

Click to enable that BVMS triggers an event when an attached skimming device detects skimming. This is not supported by all types of foyer card readers.

Default mode of electric door lock release

Open: The door is open and everybody can access without a card.

Closed: The door is closed, no matter what card is inserted.

Automatic: The door only opens when a card with access authorization is inserted in the reader.

Enable schedule-based control

Click to enable that you can assign a schedule to the selected release mode of the door lock. When a schedule becomes active, BVMS switches the foyer card reader to the corresponding release mode.

If the selected schedules overlap, the effective door release mode is determined by the following priority of modes: 1. **Open** 2. **Closed** 3. **Automatic**

13.13**Virtual Inputs page**

Main window > **Devices** > Expand  > 

Displays the virtual inputs configured in your system.

Allows you to add new virtual inputs and to delete existing ones.

Add Inputs

Click to display a dialog box for adding new virtual inputs.

Delete Inputs

Click to delete a selected virtual input.

Number

Displays the number of the virtual input.

Name



Click a cell to modify the name of the virtual input.

13.13.1**Adding Virtual Inputs manually**

Main window > **Devices** > Expand  > **Add Inputs** button

Allows you to add new virtual inputs.

To add a virtual input:

1. Expand , click  .
The corresponding page is displayed.
2. Click **Add Inputs**.
A row is added to the table.
3. Make the appropriate settings.
4. Click **Add**.
The virtual input is added to your system.

Add Inputs dialog box**Start:**

Select the first number of the new virtual inputs.

End:

Select the last number of the new virtual inputs.

Name:

Type in the name of each new virtual input. A consecutive number is appended.

Add

Click to add new virtual inputs.

13.14**SNMP page**



Main window > **Devices** > Expand  > 

Allows you to add or configure an SNMP measurement for maintaining the network quality.



Refer to

– *Configuring an SNMP trap receiver (SNMP trap receiver page), page 151*

13.14.1**Adding an SNMP manually**

Main window > **Devices** > Expand  > Right-click  > **Add SNMP** command
Allows you to add a network monitoring system to your BVMS.

To add a network monitoring device:

1. Expand , right-click  and click **Add SNMP**.
The **Add SNMP** dialog box is displayed.
2. Type a name for the SNMP device.
The network monitoring device is added to your system.

Add SNMP dialog box**Name:**

Type a name for the network monitoring device.

Refer to

– *Configuring an SNMP trap receiver (SNMP trap receiver page), page 151*

13.14.2**Configuring an SNMP trap receiver (SNMP trap receiver page)**

Main window > **Devices** > Expand 

To configure the SNMP trap receiver:

1. Click  to display the **SNMP Trap Receiver** page.
2. Make the required settings.

For detailed information on the various fields, see the Online Help for the appropriate application window.

SNMP Trap Receiver page.

Main window > **Devices** > Expand  > Expand 

Allows you to select devices for monitoring and to select SNMP trap OIDs that trigger an event for the selected device when they are received.

**Notice!**

You must enter the IP address of the Bosch Video Management System Management Server as the trap receiver in your devices that you want to monitor.

SNMP Trap Sending Devices:

Allows you to enter a range of IP addresses of the monitored network devices. To monitor a single device enter the corresponding IP address in the **Range From** cell.

Be careful when changing these addresses. Entering a wrong address stops network monitoring of this device.

SNMP Trap Filter Rules:

Allows you to enter OIDs and corresponding values. You can use wildcards as * and ? to enhance the filter range. If you enter OIDs and values in more than one row, these filter rules must match simultaneously to trigger an event. In both columns, you can enter a regular expression in {}. If there are characters outside the brackets, the regular expression is not evaluated.

Show Trap Logger Tool

Click to display the **SNMP Trap Logger** dialog box for tracing SNMP trap OIDs.

13.14.3**SNMP Trap Logger dialog box**

Main window > **Devices** > Expand  > Expand  > Select a generic SNMP Trap Receiver > Click **Show Trap Logger Tool**

Allows you to trace SNMPtrapOIDs. You can receive traps from all devices in your network or only from selected ones. You can filter the traps to be received and you can add OIDs and values of selected traps to the **SNMP Trap Filter Rules:** table.

Start/Pause

Click to start or stop a tracing process.

Only Traps From Sender

Enter the IP address or DNS name of a device. Only traps from this device are traced.

Only Traps Containing

Enter a string a trap can contain. You can use * and ? as wildcards. Strings in {} are treated as regular expressions. Only traps containing such a string are traced.

Received Traps

Displays the traps that are received by a tracing process.



Click to remove all entries in the **Received Traps** field.

Trap Details

Displays the trap details. You can copy the OID and the Value entry to the **SNMP Trap Filter Rules:** table.

Refer to

– *Configuring an SNMP trap receiver (SNMP trap receiver page), page 151*



13.15**Assign Keyboard page**

Main window > **Devices** > Expand  > 

Allows you to add a KBD-Universal XF keyboard (connected to a BVMS workstation) or a Bosch IntuiKey keyboard (connected to a BVMS workstation or to a decoder).

To add a CCTV keyboard:

Note: For adding a keyboard you must have added a workstation.

1. Expand  , click  .
The corresponding page is displayed.
2. Click **Add Keyboard**.
A row is added to the table.
3. In the appropriate field of the **Keyboard Type** column, select the desired keyboard type:
 - IntuiKey Keyboard**
 - KBD-Universal XF Keyboard**
4. In the appropriate field of the **Connection** column, select the workstation that is connected with the keyboard.
5. Make the appropriate settings.
The keyboard is added to your system.

Add Keyboard

Click to add a row to the table for configuring a keyboard.

Delete Keyboard

Click to remove the selected row.

Keyboard Type



Displays the type of the keyboard that is connected to your workstation or decoder.

Click a cell to select the required keyboard type.

- **IntuiKey**
Select this type if you have attached an IntuiKey keyboard from Bosch.
- **KBD-Universal XF Keyboard**
Select this type if you have attached a KBD-Universal XF keyboard.

Connection

In a cell, select the device your keyboard is connected to. If you select a workstation, the

keyboard is also added to the  >  page.

Port

In a cell, select the desired COM port.

Baudrate

In a cell, select the maximum rate, in bits per second (bps), that you want data to be transmitted through this port. Usually, this is set to the maximum rate supported by the computer or device you are communicating with.

Data Bits

Displays the number of data bits you want to use for each character that is transmitted and received.

Stop Bits

Displays the time between each character being transmitted (where time is measured in bits).

Parity

Displays the type of error checking you want to use for the selected port.



Port Type

Displays the connection type that is used to connect the Bosch IntuiKey keyboard with the workstation.

Refer to

- *Configuring a decoder for use with a Bosch IntuiKey keyboard, page 142*
- *Configuring a Bosch IntuiKey keyboard (settings page) (workstation), page 135*
- *Configuring a Bosch IntuiKey keyboard (decoder), page 142*

13.16**I/O Modules page**



Main window > **Devices** > Expand  > 

Allows you to add or configure an I/O module.
Currently only ADAM devices are supported.

Refer to

- *Configuring an I/O module, page 154*

13.16.1**Adding an I/O module manually****To add an I/O module:**

1. Expand , right-click  and click **Add New ADAM Device**.
The **Add ADAM** dialog box is displayed.
2. Type the IP address of the device.
3. Select the device type.
The corresponding page is displayed.
4. Click the **ADAM** tab to change the display names of the inputs if required.
5. Click the **Name** tab to change the display names of the Relays if required.

**Notice!**

You can also perform a scan for ADAM devices (**Scan for ADAM Devices**). The IP addresses of the devices are detected. If available the device type is preselected. You must confirm this selection.

13.16.2**Configuring an I/O module**

Main window > **Devices** > Expand  > Expand  > 

To configure an I/O module:**Notice!**

Avoid changing the device type.
When you reduce the number of inputs or relays, all configuration data for the removed inputs or relays are deleted.

1. Click the **ADAM** tab.
2. In the **Adam type:** list, select the appropriate device type.
3. Click the **Inputs** tab.
4. In the **Name** column, change the display name of an input if required.
5. Click the **Relays** tab.
6. In the **Relays** column, change the name of a relay if required.

To change an IP address:

1. In the device tree, right-click an ADAM device.
2. Select **Change network address**.
3. Type the new IP address and click **OK**.



4. Activate the configuration.
- ⇒ The new IP address is used to access the device.

Refer to

- *I/O Modules page, page 154*

13.16.3

ADAM page

Main window > **Devices** > Expand  >  >  > **ADAM** tab

Displays information on the selected ADAM device.
Allows you to change the display name of an ADAM device.

Adam type:

Select the appropriate device type.

Inputs total:



Displays the total number of inputs available with this device type.

Relays/Outputs total:

Displays the total number of relays available with this device type.

13.16.4

Inputs page

Main window > **Devices** > Expand  >  >  > **Inputs** tab

Allows you to change the display names of the inputs of the selected ADAM device.

Number

Displays the logical number of the input.

Name

Click a cell to change the display name of an input.

13.16.5

Relays page

Main window > **Devices** > Expand  >  >  > **Relays** tab

Allows you to change the display names of the relays of the selected ADAM device.

Number



Click a cell to change the logical number of a relay.

Name

Type the display name of the relay.

13.17

Allegiant CCL Emulation page

Main window > **Devices** > Expand  > 

Allows you to activate the Allegiant CCL emulation.
Allegiant CCL commands supported in BVMS, page 61 lists the CCL commands supported in Bosch Video Management System.

Note:

Do not configure the Allegiant CCL emulation and an Allegiant device to the same COM port. If for both devices the same COM port is configured, the Allegiant device wins. The access of the Allegiant CCL emulation device fails with an appropriate message.

To solve this, the Management Server must have two different COM ports or connect the Allegiant device to another computer.

Enable Allegiant CCL Emulation

Select the check box to enable the emulation.

Baud rate

Select the value for the transmission rate in bit/s.

Stop bits

Select the number of stop bits per character.

Parity check

Select the type of parity check.

Handshake

Select the desired method for flow control.

Model



Select the Allegiant model that you want to emulate.

Refer to

– *Configuring an Allegiant CCL emulation, page 156*

13.17.1**Adding an Allegiant CCL emulation manually**

To add an Allegiant CCL emulation:

1. Expand , click  .
The **Allegiant CCL Emulation** tab is displayed.
2. Click to check **Enable Allegiant CCL Emulation**.
3. Make the required settings.
The Allegiant CCL emulation service is started on the Management Server.

13.17.2**Allegiant CCL commands**

You use CCL commands for switching IP cameras or encoders to IP decoders both configured in BVMS. You cannot use CCL commands to directly control analog cameras or the Allegiant matrix itself.

The Allegiant CCL emulation starts an internal BVMS service that translates CCL commands of the Matrix Switch into BVMS. You configure a COM port of the Management Server to listen to these CCL commands. The CCL emulation helps to exchange existing Allegiant devices with Bosch Video Management System or to use Bosch Video Management System with applications that support the Allegiant CCL commands. Old Allegiant hardware configured in BVMS cannot be controlled with these commands.

13.17.3**Configuring an Allegiant CCL emulation**

Main window > **Devices**> Expand  > 

To use the CCL commands you need the CCL User Guide. This manual is available in the Online Product Catalog in the document section of each LTC Allegiant Matrix.

The *Allegiant CCL commands supported in BVMS, page 61* section lists the CCL commands supported in Bosch Video Management System.

To configure an Allegiant CCL emulation:

1. Click **Enable Allegiant CCL Emulation**.
 2. Configure the communication settings as required.
- For detailed information on the various fields, see the Online Help for the appropriate application window.

Refer to

- *Allegiant CCL Emulation page, page 155*

13.18 Mobile Video Service page

Main window > **Devices** > 

Allows you to add one or more transcoding service entries to your BVMS. This transcoding service adapts the video stream from a camera configured in BVMS to the available network bandwidth. This enables mobile video clients like an iPhone, iPad or Web Client to receive live or playback video data via unreliable network connections with limited bandwidth.

Refer to

- *Adding a Mobile Video Service manually, page 157*

13.18.1 Mobile Video Service

Mobile Video Service is transcoding video streams from the source to the available bandwidth of connected clients. The interfaces of the Mobile Video Service are designed to support clients on multiple platforms, for example Mobile devices (IOS; iPad, iPhone) and Windows Internet Explorer HTML client.

Mobile Video Service is based on Microsoft Internet Information Service.

One mobile service may serve several clients synchronously.

For limits refer to data sheet and the Technical Note Mobile Video Service available in the Online Product Catalog for BVMS.

Internet Information Service

Configure the settings for Internet Information Service on the computer where you plan to install MVS for BVMS.

Installation notes

You cannot add Mobile Video Service (MVS) in Configuration Client when the time between the Configuration Client computer and the Mobile Video Service computer is not synchronized. Please ensure that the time is synchronized between the affected computers. Install and configure Internet Information Service (IIS) before you install Mobile Video Service. If IIS is not installed, BVMS Setup to install Mobile Video Service aborts.

You select the Mobile Video Service component for installation during BVMS Setup.

You cannot install VRM and Mobile Video Service on the same computer.

We recommend that you do not install Mobile Video Service on the same computer where you install Management Server.

With Mobile App you can perform the following tasks:

- Displaying video
 - Live
 - Playback
- Monitoring network and server

Refer to

- *Adding a Mobile Video Service manually, page 157*

13.18.2 Adding a Mobile Video Service manually

Main window > **Devices** > Right-click  > Click **Add Mobile Video Service**

You can add one or more Mobile Video Service entries to your BVMS.

To add:

1. Type in the URI of your Mobile Video Service.
 2. Click **OK**.
- ⇒ Mobile Video Service and Management Server now know each other and the Mobile Video Service can receive configuration data from Management Server.

Add Mobile Video Service dialog box**URI**

Type in the URI of your Mobile Video Service. Follow the syntax rules of the example:

<https://www.MyDomain.org/mvs>

You must start the entry always with https://, even when you did not configure an encrypted access to your Web server.

13.19 Intrusion panels page

Main window > **Devices** > Expand  > 

Allows you to add and configure intrusion panels from Bosch. The device must be connected and available.

When you have added an intrusion panel, the areas, points, doors, and relays are displayed in the Device Tree hierarchically.

You can remove or rename the panel, each area, each point, each door, and each relay.

When the configuration on the intrusion panel was changed, you must rescan the device to display the changes in BVMS.



**Notice!**

All alarm events that can occur at a point, are automatically configured as a BVMS alarm.
Example: Fire alarm

**Notice!**



If a door is not assigned to a point in the configuration of an intrusion panel that is added to your BVMS, an alarm from this door does not trigger a BVMS event and hence no BVMS alarm.

13.19.1 Adding an Intrusion Panel manually

Main window > **Devices** > Expand  > Right-click  > **Add Panel** command

Allows you to add an intrusion panel from Bosch.

To add an intrusion panel:

1. Expand , right-click  and click **Add Panel**.
The **Add Intrusion Panel** dialog box is displayed.
2. Enter the appropriate values.
3. Click **OK**.
The intrusion panel is added to your system.

Add Intrusion Panel dialog box**Network address**

Type in the IP address of the device.

Network port

Select the port number configured in the device.

Automation passcode

Type in the passcode for authenticating at the device.

13.19.2**Settings page**

Main window > **Devices** > Expand  > Expand  >  > **Settings** tab

Allows you to change the connection settings of the intrusion panel.

13.20**Access control systems page**

Main window > **Devices** > Expand  > 

Allows you to add and configure access control systems from Bosch. The device must be connected and available. When you have added an access control system, the controller, entrances, readers and doors are displayed in the Device Tree hierarchically.

You can remove or rename the controller, entrances, readers and doors on the **Maps and structure** page.

When the configuration or hierarchy for controllers, readers or doors of the access control system was changed, you must rescan the device to display the changes in BVMS.

HTTPS Certificate for Client

In order to secure the connection between the access control system and BVMS, you have to export a client certificate from the access control system and import it into BVMS. This process is described in the section **HTTPS Certificate for Client** of the access control system documentation.

**Notice!**

If the certificate is not added, the systems will not be able to exchange information with each other.

13.20.1**Adding an access control system**

Main window > **Devices** > Expand  > 

To add an access control system:

1. Right-click  .
2. Click **Add access control system**.

The **Add access control system** dialog box is displayed.

Note: When adding an access control system, configured doors, readers, inputs and relays are listed in the device tree on the **Maps and structure** page.

Add access control system dialog box**Network address / HTTPS port**

Type the network address of the device. If required, change the port number.

User name

Displays the user name used for authenticating at the device.

Password

Type the valid password for authenticating at the device.

To test the connection:

1. Click connect.
The BVMS Configuration Client will try to connect to the access control system and retrieve the relevant information.
2. Click OK.
The access control system is added to your system, based on the information displayed.

13.20.2**Editing an access control system**

Main window > **Devices** > Expand  >  > 

To edit an access control system:

1. Right-click .
2. Click **Edit access control system**.
The **Edit access control system** dialog box is displayed.

13.20.3**Settings page**

Main window > **Devices** > Expand  >  >  > **Settings** tab

Allows you to change the connection settings of the access control system.

13.21**Video analytics page**

Main window > > **Devices** > Expand  > 

Allows you to add video analytics, Person Identification (PID) devices and LPR devices.

13.21.1**Video Analytics Settings page**

Main window > > **Devices** > Expand  > Expand  >  **Video Analytics** > **Video Analytics Settings** page

You can add a server-based video analytics device.

The credentials and the installation path to the analytics viewer application used for the video analytics device must be available.

Network address

Type in the IP address of the video analytics device. DNS name is not allowed.

User name

Type in the user name as configured in the video analytics device.

Password

Type in the password as configured in the server-based analytics device.

Analytics viewer path

Type in the relative path of the installation path of the analytics viewer application. The path is relative to `C:\Program Files (x86)\` on the computer where the viewer application is used. Example: The analytics viewer application (`AnalyticsViewer.exe`) is installed in the following directory:

```
C:\Program Files (x86)\VideoAnalytics\
```

Configure the following path in the **Analytics viewer path** field:



VideoAnalytics\AnalyticsViewer.exe

13.21.2 Adding a Video Analytics Device

Main window > > **Devices** > Right-click  > **Add Video Analytics Device** command > **Add Video Analytics Device** dialog box

When adding a server-based analytics device, you type in the credentials for the new device.

To add a server-based analytics device:

1. Expand , right-click  and click **Add Video Analytics Device**.
The **Add Video Analytics Device** dialog box is displayed.
2. Enter the appropriate values.
3. Click **OK**.
The device is added to your system.

Add Video Analytics Device dialog box

Network address

Type in the IP address of the video analytics device. DNS name is not allowed.

User name

Type in the user name as configured in the video analytics device.

Password

Type in the password as configured in the server-based analytics device.

13.21.3 Person Identification devices page

Main window > > **Devices** > Expand  > Expand  >  Person Identification devices page

Allows you to add a Person Identification device. The device must be connected and available. You can add cameras to your Person Identification device and configure Person Identification events and alarms.

Person groups

In the **Person groups** tab you can add and configure person groups.

Cameras

In the **Cameras** tab you can add cameras to your Person Identification device. The added cameras appear in a list.

Note: At first, add the appropriate cameras to the Logical Tree.

13.21.4 Adding a Person Identification device (PID)



Notice!

In the event of a central server breakdown you need to restore the BVMS configuration and the certificate Bosch VMS CA. Otherwise you can not use an existing PID without a reset, which deletes all stored persons.



We recommend to create a backup of the BVMS configuration and the certificate Bosch VMS CA.

When adding a Person Identification device, make sure the certificate that is displayed in the **Add Person Identification Device** dialog box corresponds to the PID that you want to add. From BVMS 10.1 you can add multiple PID devices.

The first PID device you add is the leading device that is connected to the BVMS system. This first PID device establishes the connection to the other PID devices and the person database is stored on it.

Note: Before you can delete the first PID device, you have to delete all other configured PID devices.

To add a Person Identification device:

1. Expand .
2. Right-click .
3. Click **Add Person Identification Device**.
The **Add Person Identification Device** dialog box is displayed.
4. Enter the appropriate values.
5. Click **View certificate...** to check, if the certificate corresponds to the PID.
6. Click **OK** to confirm.
7. Click **OK**.
The device is added to your system.

Add Person Identification Device dialog box

Network address

Type in the IP address of the device.

Port number





Type in the port number of the device.

Refer to

- *Restoring access to a PID after a BVMS central server breakdown, page 163*
- *To export configuration data:, page 95*

13.21.5

PID page

Main window > **Devices** > Expand  > Expand  >  Person Identification devices
>  PID page

Connection

The **Connection** tab displays the network address and port number of your Person Identification device. The connection settings of a Person Identification device are read-only.

13.21.6 Restoring access to a PID after a BVMS central server breakdown



Notice!

In the event of a central server breakdown you need to restore the BVMS configuration and the certificate Bosch VMS CA. Otherwise you can not use an existing PID without a reset, which deletes all stored persons.

We recommend to create a backup of the BVMS configuration and the certificate Bosch VMS CA.

For more information on saving the BVMS configuration refer to *To export configuration data, page 78*. Certificates are managed outside of BVMS in the Windows application **Manage Computer Certificates**.



Notice!

Certificates contain confidential information. Protect them by doing the following:

- Set a strong password.
- Store the certificate in a restricted area, for example a non-public server.
- Make sure that only authorized personnel can access the certificate.

To create a backup of the Bosch VMS CA certificate:

1. Open the Windows application **Manage Computer Certificates**.
2. In the folder **Trusted Root Certification Authorities** select the certificate Bosch VMS CA.
3. Export the certificate with the private key by selecting **Yes, export the private key**.
4. Use the Personal Information Exchange format.
5. Set a strong password.
6. Save the certificate as a PFX file.

To restore the access to the PID from a newly installed BVMS central server:

1. Open the Windows application **Manage Computer Certificates**.
2. Import the PFX file that contains the certificate Bosch VMS CA into the folder **Trusted Root Certification Authorities** of the new central server. Include all extended properties.
3. Import the BVMS configuration backup.



Refer to

- *Exporting configuration data, page 94*

13.21.7 Adding cameras to a Person Identification device (PID)

You can add cameras to your Person Identification device, if they are already added to the Logical tree.

To add cameras to a Person Identification device:

1. Expand .
2. Expand .
3. Click .
4. Click the **Cameras** tab.

- Drag the appropriate cameras from the **Logical Tree** window to the **Cameras** window.
Or
double-click the appropriate cameras in the **Logical Tree** window.
The cameras are added to your Person Identification device and are displayed in the **Cameras** list.

13.21.8 Configuring camera parameters for Person Identification alarms

For each available camera you can configure camera parameters for Person Identification alarms to reduce false alarms.



Camera parameter

Name	Value information	Description
Threshold probability (%)	Default: 55 % Min: 0 % Max: 100 %	The minimum probability of positive identification of a face in order to generate a Person Identification event.
Face size (%)	Default: 7,5 % Min: 5 % Max: 100 %	The minimum size of a face to be detected compared to the size of the entire video frame.
Min. frame number	Default: 4 Min.: 1	The minimum number of consecutive video frames in which a face must appear in order to be detected.
Frames to analyze (%)	Default: 100 % Min: 10 % Max: 100 %	The percentage of frames that is analyzed to identify persons. A value of 50 % means every second frame is analyzed.

13.21.9 Configuring person groups

Main window > > **Devices** > Expand  > 

To configure person groups:

- Select the **Person groups** tab.
- Click  to add a new person group.
- Enter the appropriate values.
- Click  to delete a person group.



Notice!

You can not delete or change the values of the default group.

Person groups table

Person group	Type the person group name.
Alarm Color	Double-click to select the alarm color.
Alarm Title	Type the title of the alarm that will be displayed in the Operator client.

To change the values of the person groups table:

1. Double-click in the appropriate table field.
2. Change the value.

Alarm priority

You can set the alarm priority for Person Identification alarms on the **Alarms** page.



Notice!

You can set different alarm priorities for each camera of the appropriate person group. You can also change the alarm priority of the default person group.

Refer to

- *Alarms page, page 294*

13.21.10

Adding a LPR device

Main window > > **Devices** > Expand  >  > 

LPR devices identify and detect license plate numbers. You can configure LPR events and alarms accordingly.

If the LPR device should detect specific license plate numbers, you first have to configure a list of relevant license plate numbers directly in the LPR device. For detailed information, please refer to the user documentation of the device.



Notice!

The device must be connected and available.

BVMS connects only if authentication is enabled on the LPR device, and user name and password are specified. User name and password can not be empty.

To add a LPR device:

1. Right-click 
2. Click **Add LPR Device**.
The **Add LPR Device** dialog box is displayed.
3. Enter the appropriate values.
4. Click **Authenticate**.
5. Click **OK**.
The device is added to your system.



Notice!

You have to specify the IP address of the BVMS Management Server in the LPR device configuration. Otherwise the BVMS system does not retrieve events from this LPR device.

Add LPR Device dialog box**Network address**

Type in the IP address of the device.

Port number

Type in the port number of the device.

User name

Type the valid user name for authenticating at the device.

Password

Type the valid password for authenticating at the device.

Authenticate

Click to authenticate at the device with the credentials entered above.

13.22**VRM Devices page**

Main window > **Devices** > Expand  > 

Allows you to add and configure VRM devices. A VRM device needs at least an encoder, an iSCSI device, and a LUN assigned to the iSCSI device, and a storage pool. See the Release Notes and the data sheet for current firmware versions.

**Notice!**

After you have added an iSCSI device with respective encoders to your BVMS, you must add the IQN of each encoder to this iSCSI device (valid for some iSCSI device types). See *Configuring an iSCSI device, page 188* for details.

**Notice!**

Ensure that the time of the VRM computer is synchronized with the Management Server. Otherwise you can lose recordings. Configure the time server software on the Management Server. On the VRM computer, configure the IP address of the Management Server as time server using standard Windows procedures.

Refer to

- *Configuring multicast, page 223*
- *Synchronizing BVMS configuration, page 175*
- *VRM Settings page, page 169*
- *Pool page, page 176*
- *iSCSI device page, page 184*
- *Changing the password of a VRM device, page 172*

13.22.1**Adding VRM Devices via scan**

Main window > **Devices** > 

In your network, you need a VRM service running on a computer, and an iSCSI device.







Notice!

When you add an iSCSI device with no targets and LUNs configured, start a default configuration and add the IQN of each encoder to this iSCSI device.

When you add an iSCSI device with targets and LUNs pre-configured, add the IQN of each encoder to this iSCSI device.

See *Configuring an iSCSI device, page 188* for details.

To add VRM devices via scan:

1. Right-click  and click **Scan for VRM Devices**.
The **BVMS Scan Wizard** dialog box is displayed.
 2. Select the desired check boxes for the devices that you want to add.
 3. In the **Role** list, select the desired role.
It depends on the current type of the VRM device which new role you can select.
If you select **Mirrored** or **Failover**, the next configuration step is additionally required.
 4. In the **Role** list, select the desired role.
It depends on the current type of the VRM device which new role you can select.
 5. Click **Next >>**
 6. In the **Master VRM** list, select the Master VRM for the selected Mirrored or Failover VRM.
 7. Click **Next >>**.
The **Authenticate Devices** dialog box of the wizard is displayed.
 8. Type in the password for each device that is protected by a password.
Password check is performed automatically, when you do not enter a further character in the password field for a few seconds or you click outside the password field.
If the passwords of all devices are identical, you can enter it in the first **Password** field.
Then right-click this field and click **Copy cell to column**.

- In the **Status** column, the successful logons are indicated with .
- The failed logons are indicated with .
9. Click **Finish**.
The device is added to the Device Tree.

Note: All VRM devices are added with secure connection by default.

To change secure/unsecure connection:

1. Right-click .
2. Click **Edit VRM Device**.
The **Edit VRM Device** dialog box is displayed.
3. Select the **Secure connection** check box.
The used port changes automatically to the HTTPS port.
Or
deselect the **Secure connection** check box.
The used port changes automatically to the rcpp port.

Refer to

- *Adding a device, page 123*
- *VRM Devices page, page 166*
- *Configuring an iSCSI device, page 188*
- *Dual / failover recording, page 28*

13.22.2 Adding a primary or secondary VRM manually

Main window > **Devices** > Right-click  > Click **Add VRM** > **Add VRM** dialog box
Allows you to add a VRM device. You can select the type of the device and enter the credentials.

You can effectively assign a Failover VRM to a Master VRM only when both are online and are successfully authenticated. The passwords are then synchronized.

You can add a Primary VRM device manually if you know the IP address and password.

To add a Primary VRM device:

1. Make the required settings for your VRM device.
2. In the **Type** list, select the **Primary** entry.
3. Click **OK**.

The VRM device is added.

You can add a Secondary VRM device manually if you know the IP address and password.



Notice!

For configuring a Secondary VRM you must first install the appropriate software on the desired computer. Run Setup.exe and select **Secondary VRM**.

To add a Secondary VRM device:

1. Make the required settings for your VRM device.
2. In the **Type** list, select the **Secondary** entry.
3. Click **OK**.

The VRM device is added.

You can now configure the Secondary VRM like any Primary VRM.

Add VRM dialog box

Name

Type in a display name for the device.

Network address / port

Type in the IP address of your device.

If the **Secure connection** check box is selected, the port changes automatically to HTTPS port. You can change the port number, if no default ports are used.

Type

Select the desired device type.

User name

Type in the user name for authentication.

Password

Type in the password for authentication.

Show password

Click to enable that the password is visible.

Security

The **Secure connection** check box is selected by default, if HTTPS is supported.

**Notice!**

If you migrate to BVMS version 10.0 and higher, the **Secure connection** check box is not selected by default and the connection is unsecure (rcpp).

To change secure or unsecure connection, use the **Edit VRM Device** command and select or deselect the **Secure connection** check box.

Test

Click to check whether the device is connected and authentication is successful.

Properties

If required, change the port numbers for the HTTP port and for the HTTPS port. This is only possible when you add or edit a VRM that is not connected. If the VRM is connected, the values are retrieved and you cannot change them.

The **Master VRM** table row shows the selected device if applicable.

Refer to

- *Editing a VRM device, page 169*
- *Adding a Mirrored VRM manually, page 173*
- *Adding a Failover VRM manually, page 172*

13.22.3**Editing a VRM device**

Main window > **Devices**

Allows you to edit a VRM device.

To change secure/unsecure connection:

1. Right-click  .
2. Click **Edit VRM Device**.
The **Edit VRM Device** dialog box is displayed.
3. Select the **Secure connection** check box.
The used port changes automatically to the HTTPS port.
Or
deselect the **Secure connection** check box.
The used port changes automatically to the rcpp port.

**Notice!**

After upgrading to a newer version, we recommend changing to secure connection.

For detailed information about the parameter of the **Edit VRM Device** dialog box, see chapter Adding a primary or secondary VRM manually.

Refer to

- *Adding a primary or secondary VRM manually, page 168*

13.22.4**VRM Settings page**

Main window > **Devices** > Expand  >  > **Main Settings** > **VRM Settings**

Server initiator name

Displays the iSCSI initiator name of VRM Server.

13.22.5

SNMP page

Main window > **Devices** > Expand  > Expand  > **Network** > **SNMP**

1. SNMP host address 2. SNMP host address

VRM supports the SNMP (Simple Network Management Protocol) for managing and monitoring network components, and can send SNMP messages (traps) to IP addresses. The unit supports SNMP MIB II in the unified code. If you wish to send SNMP traps, enter the IP addresses of one or two required target units here.

Some events are sent as SNMP traps only. Refer to the MIB file for descriptions.

13.22.6

Accounts page

In order to configure image posting, and to export video in MP4 file format, you must create an Account in which to save and access them. You can create a maximum of four (4) accounts.

Type

Select the type of account: **FTP** or **Dropbox**.

IP address

Enter the IP address of the server on which you wish to save the images.

User name

Enter the user name for the server.

Password

Enter the password that gives you access to the server. To verify the password, click **Check** to the right.

Check

Click to verify the password.

Path

Enter the exact path on which you wish to post the images and video on the server.

13.22.7

Advanced page

Main window > **Devices** > Expand  > Expand  > **Service** > **Advanced**

RCP+ logging / Debug logging / Replay logging / VDP logging / Performance logging

Activate the different logs for VRM Server and Configuration Manager.

The log files for VRM Server are stored on the computer on which VRM Server has been started, and can be viewed or downloaded with VRM Monitor.

The log files for Configuration Manager are stored locally in the following directory:
%USERPROFILE%\My Documents\Bosch\Video Recording Manager\Log

Retention time (days)

Specify the retention time for log files in days.

Complete memory dump file

Only select this check box if necessary, for example, if the Technical Customer Service team requests a complete summary of the main memory.

Telnet support

Select this check box if access with the Telnet protocol is to be supported. Only select if necessary.

**Notice!**

Extensive logging requires considerable CPU power and HDD capacity.
Do not use extensive logging in continuous operation.

13.22.8**Encrypting recording for VRM**

Encrypted recording for VRM encoders is not enabled by default.
You have to enable encrypted recording for the primary and secondary VRM separately.

**Notice!**

You have to create a redundancy key (backup certificate) before you enable encrypted recording for the first time. You only have to create a redundancy key once for each VRM device.

In any case of loss of the regular encryption key, you can decrypt the recordings with the redundancy key.

We recommend to keep a copy of the redundancy key at a secure place (for example in a safe).

To create a redundancy key:

1. Select the appropriate VRM device.
2. Select the **Service** tab.
3. Select the **Recording encryption** tab.
4. Click **Redundancy key**.
5. Choose a certification store location.
6. Type in a password that meets the password complexity requirements, and confirm.
7. Click **Create**.

The redundancy key (backup certificate) is created.

To enable/disable encrypted recording:

1. Select the appropriate VRM device.
2. Select the **Service** tab.
3. Select the **Recording encryption** tab.
4. Select/deselect the **Enable encrypted recording** check box.

5. Click  .

Note: Encryption is only enabled after the next block change. This may take a while.
Please check to ensure that the encoders are encrypting.

To check the VRM encoders that are encrypting:

1. Select the appropriate VRM device.
2. Select the **Service** tab.
3. Select the **Recording encryption** tab.

Note: You can also refer to the **Monitoring** tab in the VRM Monitor.

**Notice!**

All VRM encoders, that support encryption, are automatically encrypting recording after encryption is enabled in the VRM.

Encryption can be disabled for a single encoder.

VSG encoders are always encrypting, if encryption is enabled in the VRM.

To enable/disable encrypted recording for a single VRM encoder:

1. Select the appropriate VRM encoder.
2. Select the **Recording** tab.
3. Select the **Recording management** tab.
4. Select/deselect the **Encryption** check box.

5. Click .

13.22.9**Changing the password of a VRM device**

Main window > **Devices** > Expand  > 

To change the password:

1. Right-click  and click **Change VRM Password**.
The **Change password** dialog box is displayed.
2. In the **Old Password** field, type in the appropriate password.
3. In the **New Password** field, type in the new password and click and repeat this entry in the second **New Password** field.



Click **OK**.

- ▶ Confirm the next dialog box.
- ⇒ The password is changed immediately on the device.

13.22.10**Adding a VRM pool**

Main window > **Devices** > Expand 



To add a VRM pool:

- ▶ Right-click  or  and click **Add Pool**.
A new pool is added to the system.

Refer to

– *iSCSI storage pool, page 184*

13.22.11**Adding a Failover VRM manually**

Main window > **Devices** > Expand  > Right-click  > Click **Add Failover VRM** > **Add Failover VRM** dialog box

**Notice!**

For configuring a Secondary VRM you must first install the appropriate software on the desired computer. Run Setup.exe and select **Secondary VRM**.

Either a Primary VRM or a Secondary VRM can take over the role of a Failover VRM. You add a Primary Failover VRM to a Primary VRM or you add a Secondary Failover VRM to a Secondary VRM.

You can add a Failover VRM device manually if you know the IP address and password. The initially selected VRM is the Master VRM for this Failover VRM.

You can add a Failover VRM device. You can either add it manually or you can select a device from a list of scanned VRM devices.

You can effectively assign a Failover VRM to a Master VRM only when both are online and are successfully authenticated. The passwords are then synchronized.

To add a Failover VRM device:

1. Make the required settings for your VRM device.
 2. Ensure that the correct Master VRM is selected. If not, cancel this procedure.
 3. Click **OK**.
- ⇒ The Failover VRM device is added to the selected Master VRM.

Add Failover VRM dialog box

Network address

Type in the IP address of your device or select a network address in the **Scanned VRMs** list.

Scanned VRMs

Displays the list of scanned VRM computers. To rescan, close the dialog box and display the dialog box again.



Notice!

The Failover VRM device inherits the settings that are configured in the Master VRM. If the settings of the Master VRM are changed, the settings of the Failover VRM device are changed accordingly.

Refer to

– *Dual / failover recording, page 28*

13.22.12

Adding a Mirrored VRM manually

Main window > **Devices** > Expand  > Right-click  > Click **Add Mirrored VRM** > **Add VRM** dialog box



Notice!

For configuring a Secondary VRM you must first install the appropriate software on the desired computer. Run Setup.exe and select **Secondary VRM**.

Only a Secondary VRM can take over the role of a Mirrored VRM. You add a Mirrored VRM to a Primary VRM.

You can add a Mirrored VRM device manually if you know the IP address and password. The initially selected VRM is the Master VRM for this Mirrored VRM.

To add a Mirrored VRM device:

1. Make the required settings for your VRM device.
2. Ensure that the correct Master VRM is selected. If not, cancel this procedure.
3. Click **OK**.

The Mirrored VRM device is added to the selected Primary VRM.

Add VRM dialog box

Name

Type in a display name for the device.

Network address / port

Type in the IP address of your device.

If the **Secure connection** check box is selected, the port changes automatically to HTTPS port. You can change the port number, if no default ports are used.

Type

Select the desired device type.

User name

Type in the user name for authentication.

Show password

Click to enable that the password is visible.

Password

Type in the password for authentication.

Security

The **Secure connection** check box is selected by default, if HTTPS is supported.

**Notice!**

If you migrate to BVMS version 10.0 and higher, the **Secure connection** check box is not selected by default and the connection is unsecure (rcpp).

To change secure or unsecure connection, use the **Edit VRM Device** command and select or deselect the **Secure connection** check box.

Test

Click to check whether the device is connected and authentication is successful.

Properties

If required, change the port numbers for the HTTP port and for the HTTPS port. This is only possible when you add or edit a VRM that is not connected. If the VRM is connected, the values are retrieved and you cannot change them.

The **Master VRM** table row shows the selected device if applicable.

Refer to

- *Adding a primary or secondary VRM manually, page 168*
- *Dual / failover recording, page 28*

13.22.13**Adding Encoders via scan****To add encoders via scan:**

1. Right-click  and click **Scan for Encoders**.
The **BVMS Scan Wizard** dialog box is displayed.
2. Select the required encoders, select the desired VRM pool and click **Assign** to assign them to the VRM pool.
3. Click **Next >>**.
The **Authenticate Devices** dialog box of the wizard is displayed.
4. Type in the password for each device that is protected by a password.
Password check is performed automatically, when you do not enter a further character in the password field for a few seconds or you click outside the password field.
If the passwords of all devices are identical, you can enter it in the first **Password** field.
Then right-click this field and click **Copy cell to column**.

In the **Status** column, the successful logons are indicated with .

The failed logons are indicated with .



- Click **Finish**.
The device is added to the Device Tree.

The  icon indicates an error that you need to take care of. Check the tool tip for more information about the specific error.

13.22.14 Adding VSG devices via scan

To add VSG devices via scan:

- Right-click  and click **Scan for Video Streaming Gateways**.
The **BVMS Scan Wizard** dialog box is displayed.
- Select the required VSG devices, select the desired VRM pool and click **Assign** to assign them to the VRM pool.
- Click **Next >>**.
The **Authenticate Devices** dialog box of the wizard is displayed.
- Type in the password for each device that is protected by a password.
Password check is performed automatically, when you do not enter a further character in the password field for a few seconds or you click outside the password field.
If the passwords of all devices are identical, you can enter it in the first **Password** field.
Then right-click this field and click **Copy cell to column**.

In the **Status** column, the successful logons are indicated with  .

The failed logons are indicated with

- Click **Finish**.
The device is added to the Device Tree.

13.22.15 Synchronizing BVMS configuration

Main window > **Devices** > Expand  > Right-click  > **Synchronize BVMS Configuration** command

As of BVMS 6.0, VRM 3.50 is supported. When you do not upgrade VRM to version 3.50 during the upgrade to BVMS 6.0, recording continues but you cannot change the configuration of the old VRM.

If you upgraded your VRM software to version 3.50, you must manually synchronize the BVMS configuration.

13.22.16 Importing configuration from VRM

Main window > **Devices** > Expand  > 

In case you have to exchange a primary VRM device, you can import the configuration of the former primary VRM device.

Note: This is only possible for primary VRM devices.

Prerequisite: A backup of the former VRM device configuration file (config.xml) was performed. How to perform a backup, see *Maintaining BVMS, page 78*.

To import configuration from VRM:



- Copy the backup VRM configuration file (config.xml) to C:
\\ProgramData\\Bosch\\VRM\\primary.

2. Right-click .
3. Select **Import configuration from VRM**.
The configuration of the former VRM is imported.

**Notice!**

Only the encoder, VSG and iSCSI configuration is imported.
You have to redo all other configuration, for example adding the required devices to the **Logical Tree**, configuring alarms or recording settings.

13.23**Pool page**

Main window > **Devices** > Expand  > Expand  > 

Allows you to configure recording settings valid for all devices that are collected in this storage pool.

Pool identification

Displays the pool number.

Recording preferences mode– **Failover**

Recordings are saved only to primary target. If it is not possible to save to this target, the recording will be saved to the target entered under secondary target.

A failure situation is reached if the primary target does not provide storage blocks, for example, due to system down, network error, or no capacity left.

You can leave the secondary target list empty. In this case no failover is possible but the number of required iSCSI sessions is reduced and no disk space on secondary target is allocated. This reduces system overhead and extends the system retention time.

Note: For each camera and encoder you must then configure the primary and secondary target.

– **Automatic**

Load balancing is configured automatically. The **Automatic** mode tries automatically to optimize the retention time of the available iSCSI targets. To allocate the blocks of the second iSCSI target, select **On** in the **Secondary target usage** list.

Sanity check period (days)

Enter the required time period. After this time period the Video Recording Manager program makes an analyze whether the storage distribution in the **Automatic** mode is still optimal. And if not, the Video Recording Manager program makes changes.

Secondary target usage

Allows you to select whether blocks are distributed from a second target.

Select **On** or **Off** to turn on or off the use of a secondary target.

- **On:** Select **On** to use a secondary target to reduce the recording gap in case of primary target failure. If the primary target is available, the blocks on the secondary target are not used but the storage is allocated. This redundancy reduces the retention time of the system.
- **Off:** Select **Off** if you want to use no secondary target. In case of primary target failure the Video Recording Manager program needs more time to reorganize. This means that the recording gap is larger.

Block reservation for downtime

Enter the number of days that the assigned encoders will be recorded although the VRM Server is down.

For example, if you enter 4, the encoders will be recorded during approximately 4 days of VRM Server downtime.

If your system has encoders with low bit rate, you can significantly reduce the pre-allocated disk space. This ensures a proper distribution of storage capacity and extends the retention time.

Allow LUNs larger than 2 TB

Click to enable the use of LUNs that are larger than 2 TB.

LUNs larger than 2 TB ("large LUNs") are not supported by the following devices:

- VRM devices earlier than 3.60
- VSG devices with firmware version earlier than 6.30
- Encoders with firmware version earlier than 6.30

BVMS prevents you to perform the following procedures:

- Add or move devices with firmware version earlier than 6.30 to a pool that allows large LUNs.
- Add or move devices that are currently not connected to the network, to a pool that allows large LUNs.
- Add or move an iSCSI device that contains large LUNs, to a pool that does not allow large LUNs.
- Allow large LUNs on a pool that contains devices with firmware version earlier than 6.30.
- Disable large LUNs on a pool with an iSCSI device that contains large LUNs.



Please move devices with firmware earlier than 6.30 to a pool that does not allow large LUNs.

Refer to

- *Adding a LUN, page 192*
- *Adding a VRM pool, page 172*

13.23.1

Configuring automatic recording mode on a pool

Main window > **Devices** > Expand  > Expand  > 

Notice:

If you have configured a failover recording mode earlier, this configuration is overwritten.

To configure:



- ▶ In the **Recording preferences mode** list, select **Automatic**.
After activation of the configuration the **Automatic** recording mode is active. On the **Recording Preferences** page of an encoder, the primary and the secondary target list are disabled.

Related Topics

- *Configuring failover recording mode on an encoder, page 222*

13.23.2

Adding an Encoder / Decoder manually

Main window > **Devices** > Expand  > Expand  > Right-click  > Click **Add Encoder**

> **Add Encoder** dialog box

or

Main window > **Devices** > Right-click  > Click **Add Encoder** > **Add Encoder** dialog box

or

Main window > **Devices** > Right-click  > Click **Add Encoder** > **Add Encoder** dialog box
or





Main window > **Devices** > Expand  > Right-click  > Click **Add Decoder** > **Add Encoder** dialog box

Allows you to add an encoder or decoder manually. This is especially useful when you want to add any Video IP device from Bosch (only for VRM).

Notice:

If you add a Video IP encoder or decoder from Bosch with the **<Auto Detect>** selection, this device must be available in the network.

To add a Video IP device from Bosch:

1. Expand , expand , right-click .
Or
Right-click .
Or
Right-click .

2. Click **Add Encoder**.
The **Add Encoder** dialog box is displayed.
3. Enter the appropriate IP address.
4. In the list, select **<Auto Detect>**.
5. Click **OK**.
The device is added to the system.

The  icon indicates an error that you need to take care of. Check the tool tip for more information about the specific error.

Add Encoder dialog box

IP address:

Type in a valid IP address.

Encoder type: / Decoder type:

For a device with known device type, select the appropriate entry. It is not necessary that the device is available in the network.

If you want to add any Video IP device from Bosch, select **<Auto Detect>**. The device must be available in the network.

If you want to add a camera for offline configuration, select **<Single placeholder camera>**.

13.23.3 Adding an iSCSI device manually

Main window > **Devices** >  > Expand  > Right-click  > **Add iSCSI device** > **Add iSCSI device** dialog box

Allows you to add an iSCSI device to a VRM.

To add an iSCSI device:

1. Right-click  and click **Add iSCSI device**.
The **Add iSCSI device** dialog box is displayed.
2. Type the desired display name, the network address of an iSCSI device, and the device type and click **OK**.
The iSCSI device is added to the selected VRM pool.
If required, add targets and LUNs.

Add iSCSI device dialog box**Name**

Type in a display name for the device.

Network Address

Type in a valid network address of the device.

iSCSI device type

Select the appropriate device type.

User name

Type in the user name for authentication.

Password

Type in the password for authentication.

Enable monitoring

If a DIVAR IP device is selected as iSCSI device type and any SNMP (Simple Network Management Protocol) monitoring is supported for that type of DIVAR IP device, the **Enable monitoring** checkbox is enabled.

Select the check box to enable monitoring the health state of the DIVAR IP device. BVMS now automatically receives and analyses SNMP traps of the DIVAR IP device and activates health monitoring events and alarms (for example CPU, storage, fan, ...). As default only critical alarms are triggered.

Note: Make sure to configure SNMP on the DIVAR IP device first.

Note: This setting is only available for supported devices.

For further information on how to configure SNMP on a DIVAR IP device, refer to the respective DIVAR IP documentation.

Related Topics

- *Adding VRM Devices via scan, page 166*

Refer to

- *SNMP page, page 151*
- *Configuring SNMP monitoring, page 96*

13.23.4**Adding a Video Streaming Gateway manually**

Main window > **Devices** > Expand  > 

You can add VSG devices to a VRM pool.

To add a VSG device manually:

1. Right-click  and click **Add Video Streaming Gateway**.
The **Add Video Streaming Gateway** dialog box is displayed.
2. Make the required settings for your VSG device.
3. Click **Add**.

⇒ The VSG device is added to the system. The cameras assigned to this VSG device are recorded.

Add Video Streaming Gateway dialog box

Right-click  > **Add Video Streaming Gateway** > **Add Video Streaming Gateway** dialog box

Name

Type in the desired display name for the device.

User name

Type in the user name used for authenticating at the device. Usually: service

Network address / port

Type the IP address of your device.

If the **Secure connection** check box is selected, the port changes automatically to HTTPS port. You can change the port number, if no default ports are used or the VSG instances are configured in a different order.

Default ports

VSG instance	rcpp port	HTTPS port
1	8756	8443
2	8757	8444
3	8758	8445
4	8759	8446
5	8760	8447
6	8761	8448
7	8762	8449

Password

Type in the valid password for authenticating at the device.

Show password

Click to enable that the entered password is displayed. Be careful that nobody can spy out this password.

Security

The **Secure connection** check box is selected by default, if HTTPS is supported. From VSG version 7.0, VSG supports secure connection.



Notice!

If you migrate to BVMS version 10.0 and higher, the **Secure connection** check box is not selected by default and the connection is unsecure (rcpp).

To change secure or unsecure connection, use the **Edit Video Streaming Gateway** command and select or deselect the **Secure connection** check box.

Test

Click to authenticate at the device with the credentials entered above.

Refer to

- *Editing a Video Streaming Gateway, page 195*

13.23.5

Adding a DSA E-Series iSCSI device manually

Main window > **Devices** >  > Expand  > 

You can either add an E-Series iSCSI device that is already initialized or you add an E-Series iSCSI device that is not initialized.

You can add LUNs larger than 2 TB if the pool is enabled for large LUNs.

LUNs larger than 2 TB ("large LUNs") are not supported by the following devices:

- VRM devices earlier than 3.60
- VSG devices with firmware version earlier than 6.30
- Encoders with firmware version earlier than 6.30

BVMS prevents you to perform the following procedures:

- Add or move devices with firmware version earlier than 6.30 to a pool that allows large LUNs.
- Add or move devices that are currently not connected to the network, to a pool that allows large LUNs.
- Add or move an iSCSI device that contains large LUNs, to a pool that does not allow large LUNs.
- Allow large LUNs on a pool that contains devices with firmware version earlier than 6.30.
- Disable large LUNs on a pool with an iSCSI device that contains large LUNs.



Please move devices with firmware earlier than 6.30 to a pool that does not allow large LUNs.

To add an initialized iSCSI device:

1. Right-click  and then click **Add DSA E-Series Device**.
The **Add DSA E-Series Device** dialog box is displayed.
2. Type in the management IP address and the password.
3. Click **Connect**
If connection is established, the fields in the **Controller** group and/or the **2nd Controller** group are filled.
4. Click **OK**.
The device is added to the system.
The available targets are automatically scanned and the LUNS are displayed.
You can use the iSCSI device.
If the pool is enabled for large LUNs, and the iSCSI device has large LUNs configured, the **Large LUN** column displays a checkmark for the affected LUNs.



To add a not initialized iSCSI device:

1. Right-click  and then click **Add DSA E-Series Device**.
The **Add DSA E-Series Device** dialog box is displayed.
2. Type in the management IP address and the password.
3. Click **Connect**
If connection is established, the fields in the **Controller** group and/or the **2nd Controller** group are filled.
4. Click **OK**.
The device is added to the system.

5. Click  and then click  .

6. Click the **Basic Configuration** tab.
7. Type in the desired LUN capacity.
If you type in a value larger than 2 TB, you must enable your pool for LUNs larger than 2 TB.
8. Click **Initialize**.
The LUNs are created.
9. Click **Close**.
10. Right-click the iSCSI device, and then click **Scan Target**.
The LUNs are displayed with an unknown state.
11. Save and activate the configuration.
12. Format all LUNs.
13. If you added an iSCSI device with dual controller, remove the desired LUNs from the first controller, right-click the second controller, and click **Scan Target** to add these LUNs.

Add DSA E-Series Device dialog box

Main window > **Devices** >  > Expand  > Right-click  > **Add DSA E-Series Device** > **Add DSA E-Series Device** dialog box

Allows you to add a DSA E-Series iSCSI device. This device type has a management IP address different from the IP address of the iSCSI storage. Via this management IP address the device is automatically detected and configured.

Name

Type in a display name for the device.

Management address

Type in the IP address for automatic configuration of the device.

Password

Type the password of this device.

DSA E-Series type

Displays the device type.

Network address iSCSI Ch

Displays the IP address of the iSCSI port of the device. If available you can select another IP address.

Management address

Displays the IP address for automatic configuration of the second controller if available. If available you can select another IP address.

Network address iSCSI Ch

Displays the IP address of the iSCSI port of the second controller if available. If available you can select another IP address.

Connect

Click to detect the settings of the device.

If connection is established, the fields in the **Controller** group and the **2nd Controller** group are filled.

Refer to

- *Basic Configuration page, page 189*
- *Formatting a LUN, page 193*

13.23.6 Adding Encoders via scan

To add encoders via scan:

1. Right-click  and click **Scan for Encoders**.
The **BVMS Scan Wizard** dialog box is displayed.
2. Select the required encoders, select the desired VRM pool and click **Assign** to assign them to the VRM pool.
3. Click **Next >>**.
The **Authenticate Devices** dialog box of the wizard is displayed.
4. Type in the password for each device that is protected by a password.
Password check is performed automatically, when you do not enter a further character in the password field for a few seconds or you click outside the password field.
If the passwords of all devices are identical, you can enter it in the first **Password** field.
Then right-click this field and click **Copy cell to column**.

In the **Status** column, the successful logons are indicated with .

The failed logons are indicated with .

5. Click **Finish**.
The device is added to the Device Tree.

The  icon indicates an error that you need to take care of. Check the tool tip for more information about the specific error.

13.23.7 Adding VSG devices via scan

To add VSG devices via scan:



1. Right-click  and click **Scan for Video Streaming Gateways**.
The **BVMS Scan Wizard** dialog box is displayed.
2. Select the required VSG devices, select the desired VRM pool and click **Assign** to assign them to the VRM pool.
3. Click **Next >>**.
The **Authenticate Devices** dialog box of the wizard is displayed.
4. Type in the password for each device that is protected by a password.
Password check is performed automatically, when you do not enter a further character in the password field for a few seconds or you click outside the password field.
If the passwords of all devices are identical, you can enter it in the first **Password** field.
Then right-click this field and click **Copy cell to column**.

In the **Status** column, the successful logons are indicated with .

The failed logons are indicated with .

5. Click **Finish**.
The device is added to the Device Tree.

13.23.8 Configuring dual recording in the Device Tree

Main window > **Devices** > Expand  >  > 

You must disable the ANR function to configure dual recording.

If you configure dual recording for one camera of a multi-channel encoder, the system ensures that the same recording target is configured for all cameras of this encoder.

You can configure dual recording by assigning encoders that are recorded by a Primary VRM to a Secondary VRM. This is for example useful when you want to assign only a part of the encoders that are recorded by a Primary VRM.

A Secondary VRM must already be added.

To configure:

1. Right-click  and click **Add Encoder from Primary VRM**.
The **Add Encoders** dialog box is displayed.
2. Click to select the desired encoders.
When you select a pool or a VRM, all child items are automatically selected.
3. Click **OK**.
The selected encoders are added to the Secondary VRM.

Refer to

- *Configuring dual recording in the Camera Table, page 287*
- *Configuring the ANR function, page 287*
- *Dual / failover recording, page 28*

13.24 Bosch Encoder / Decoder page

To configure a Bosch Encoder / Decoder, see *Bosch Encoder / Decoder / Camera page, page 209*.

13.25 iSCSI device page

Main window > **Devices** > Expand  > Expand  > Expand  > Expand 

You can either add a E-Series iSCSI device or any other supported iSCSI device.

Refer to

- *Adding an iSCSI device manually, page 185*
- *Adding a DSA E-Series iSCSI device manually, page 186*
- *Configuring an iSCSI device, page 188*
- *Adding a LUN, page 192*
- *Formatting a LUN, page 193*

13.25.1 iSCSI storage pool

A storage pool can be used to have a logical mapping of the network topology to the Video Recording Manager system. For example: 2 buildings, both containing storage and devices, you want to avoid routing the network traffic from one building to the other.

Storage pools can also be used to group cameras and storage systems by an important aspect of view. For example a system contains of some very important cameras and a lot of less important ones. In this case it is possible to group them into two storage pools, one with a lot of redundancy features and one with less redundancy.

You can configure the following load balancing properties for a storage pool:

- Recording preferences (**Automatic** or **Failover**)
- Secondary target usage
Secondary target is used in case of **Failover** mode if the assigned primary target fails. If this option is turned off, the recording stops on all devices assigned to this failed primary

target.

In case of **Automatic** mode: if one target fails, VRM Server performs an automatic reassign of the related devices to other storages. If the VRM Server is down while a target fails, the recording is stopped on the devices currently recording on the failed target.

- Block reservation for downtime
- Sanity check period

For each pool you can configure that this pool allows LUNs larger than 2 TB.

LUNs larger than 2 TB ("large LUNs") are not supported by the following devices:

- VRM devices earlier than 3.60
- VSG devices with firmware version earlier than 6.30
- Encoders with firmware version earlier than 6.30

BVMS prevents you to perform the following procedures:

- Add or move devices with firmware version earlier than 6.30 to a pool that allows large LUNs.
- Add or move devices that are currently not connected to the network, to a pool that allows large LUNs.
- Add or move an iSCSI device that contains large LUNs, to a pool that does not allow large LUNs.
- Allow large LUNs on a pool that contains devices with firmware version earlier than 6.30.
- Disable large LUNs on a pool with an iSCSI device that contains large LUNs.

Please move devices with firmware earlier than 6.30 to a pool that does not allow large LUNs.



If a Primary VRM has a pool that allows large LUNs, the corresponding Mirrored VRM inherits this setting and you cannot select or clear the **Allow LUNs larger than 2 TB** checkbox on the corresponding pool of the Mirrored VRM. If you have added an iSCSI device with large LUNs to a Mirrored VRM, you cannot clear the **Allow LUNs larger than 2 TB** checkbox on the corresponding pool of the Primary VRM.

Refer to

- *Pool page, page 176*

13.25.2

Adding an iSCSI device manually

Main window > **Devices** >  > Expand  > Right-click  > **Add iSCSI device** > **Add iSCSI device** dialog box

Allows you to add an iSCSI device to a VRM.

To add an iSCSI device:

1. Right-click  and click **Add iSCSI device**.
The **Add iSCSI device** dialog box is displayed.
2. Type the desired display name, the network address of an iSCSI device, and the device type and click **OK**.
The iSCSI device is added to the selected VRM pool.
If required, add targets and LUNs.

Add iSCSI device dialog box

Name

Type in a display name for the device.

Network Address

Type in a valid network address of the device.

iSCSI device type

Select the appropriate device type.

User name

Type in the user name for authentication.

Password

Type in the password for authentication.

Enable monitoring

If a DIVAR IP device is selected as iSCSI device type and any SNMP (Simple Network Management Protocol) monitoring is supported for that type of DIVAR IP device, the **Enable monitoring** checkbox is enabled.

Select the check box to enable monitoring the health state of the DIVAR IP device. BVMS now automatically receives and analyses SNMP traps of the DIVAR IP device and activates health monitoring events and alarms (for example CPU, storage, fan, ...). As default only critical alarms are triggered.

Note: Make sure to configure SNMP on the DIVAR IP device first.

Note: This setting is only available for supported devices.

For further information on how to configure SNMP on a DIVAR IP device, refer to the respective DIVAR IP documentation.

Related Topics

- *Adding VRM Devices via scan, page 166*

Refer to

- *SNMP page, page 151*
- *Configuring SNMP monitoring, page 96*

13.25.3**Adding a DSA E-Series iSCSI device manually**

Main window > **Devices** >  > Expand  > 

You can either add an E-Series iSCSI device that is already initialized or you add an E-Series iSCSI device that is not initialized.

You can add LUNs larger than 2 TB if the pool is enabled for large LUNs.

LUNs larger than 2 TB ("large LUNs") are not supported by the following devices:

- VRM devices earlier than 3.60
- VSG devices with firmware version earlier than 6.30
- Encoders with firmware version earlier than 6.30

BVMS prevents you to perform the following procedures:

- Add or move devices with firmware version earlier than 6.30 to a pool that allows large LUNs.
- Add or move devices that are currently not connected to the network, to a pool that allows large LUNs.
- Add or move an iSCSI device that contains large LUNs, to a pool that does not allow large LUNs.
- Allow large LUNs on a pool that contains devices with firmware version earlier than 6.30.
- Disable large LUNs on a pool with an iSCSI device that contains large LUNs.



Please move devices with firmware earlier than 6.30 to a pool that does not allow large LUNs.

To add an initialized iSCSI device:



1. Right-click  and then click **Add DSA E-Series Device**.
The **Add DSA E-Series Device** dialog box is displayed.

2. Type in the management IP address and the password.
3. Click **Connect**
If connection is established, the fields in the **Controller** group and/or the **2nd Controller** group are filled.
4. Click **OK**.
The device is added to the system.
The available targets are automatically scanned and the LUNS are displayed.
You can use the iSCSI device.
If the pool is enabled for large LUNs, and the iSCSI device has large LUNs configured, the **Large LUN** column displays a checkmark for the affected LUNs.

To add a not initialized iSCSI device:

1. Right-click  and then click **Add DSA E-Series Device**.
The **Add DSA E-Series Device** dialog box is displayed.
2. Type in the management IP address and the password.
3. Click **Connect**
If connection is established, the fields in the **Controller** group and/or the **2nd Controller** group are filled.
4. Click **OK**.
The device is added to the system.
5. Click  and then click .
6. Click the **Basic Configuration** tab.
7. Type in the desired LUN capacity.
If you type in a value larger than 2 TB, you must enable your pool for LUNs larger than 2 TB.
8. Click **Initialize**.
The LUNs are created.
9. Click **Close**.
10. Right-click the iSCSI device, and then click **Scan Target**.
The LUNs are displayed with an unknown state.
11. Save and activate the configuration.
12. Format all LUNs.
13. If you added an iSCSI device with dual controller, remove the desired LUNs from the first controller, right-click the second controller, and click **Scan Target** to add these LUNs.

Add DSA E-Series Device dialog box

Main window > **Devices** >  > Expand  > Right-click  > **Add DSA E-Series Device** > **Add DSA E-Series Device** dialog box

Allows you to add a DSA E-Series iSCSI device. This device type has a management IP address different from the IP address of the iSCSI storage. Via this management IP address the device is automatically detected and configured.

Name

Type in a display name for the device.

Management address

Type in the IP address for automatic configuration of the device.

Password

Type the password of this device.

DSA E-Series type

Displays the device type.

Network address iSCSI Ch

Displays the IP address of the iSCSI port of the device. If available you can select another IP address.

Management address

Displays the IP address for automatic configuration of the second controller if available. If available you can select another IP address.

Network address iSCSI Ch

Displays the IP address of the iSCSI port of the second controller if available. If available you can select another IP address.

Connect

Click to detect the settings of the device.

If connection is established, the fields in the **Controller** group and the **2nd Controller** group are filled.

Refer to

- *Basic Configuration page, page 189*
- *Formatting a LUN, page 193*

13.25.4**Configuring an iSCSI device**

Main window > **Devices** > Expand  > Expand  > 

After adding VRM devices, iSCSI devices, and encoders, perform the following tasks to ensure that video data of encoders is stored on the iSCSI devices or video data can be retrieved from these iSCSI devices:

- Execute the default configuration to create LUNs on each target of the iSCSI device. This step is optional. You do not need to perform this step on an iSCSI device with LUNs pre-configured.
- Scan the iSCSI device to add the targets and LUNs to the Device Tree after default configuration.



Note:

Not all iSCSI devices support the default configuration and automatic IQN mapping.

Prerequisite:

The iSCSI device must be configured with valid IP addresses.

To perform basic configuration of an DSA E-Series iSCSI device:

- ▶ Expand the appropriate VRM device  and , click the appropriate iSCSI device .







1. Click the **Basic Configuration** tab.
2. Type in the desired LUN capacity.
If you type in a value larger than 2 TB, you must enable your pool for LUNs larger than 2 TB.
3. Click **Initialize**.
The LUNs are created.
4. Click **Close**.

5. Right-click the iSCSI device, and then click **Scan Target**.
The LUNs are displayed with an unknown state.
6. Save and activate the configuration.
7. Format all LUNs.
8. If you added an iSCSI device with dual controller, remove the desired LUNs from the first controller, right-click the second controller, and click **Scan Target** to add these LUNs.

To perform basic configuration on other iSCSI devices:

1. Click the **Basic Configuration** tab.
2. Type in the desired LUN count.
3. Click **Set**.
The LUNs are created.
4. Click **Close**.
5. Right-click the iSCSI device, and then click **Scan Target**.
The LUNs are displayed with an unknown state.
6. Save and activate the configuration.
7. Format all LUNs.

To perform IQN mapping for other iSCSI devices:

1. Expand the appropriate VRM device  and , click the appropriate iSCSI device .
2. Right-click  and click **Map IQNs**.
The iqn-Mapper dialog box is displayed and the process is started.
The encoders that are assigned to the selected VRM device are evaluated and their IQNs are added to this iSCSI device.
3. Click  to save the settings.
4. Click  to activate the configuration.

Refer to

- *Basic Configuration page, page 189*
- *Load Balancing dialog box, page 190*
- *iqn-Mapper dialog box, page 193*
- *Formatting a LUN, page 193*

13.25.5

Basic Configuration page

Main window > **Devices** > Expand  > Expand  > Expand  > Click  > **Basic Configuration** tab

The displayed options can differ depending on the used type of iSCSI storage system. Allows you to perform a basic configuration of your iSCSI device. You create LUNs on the iSCSI hard drive and format these LUNs.

Only displayed if the device is one of the iSCSI storage systems supported by Bosch, for example DSA or DLS 1x00.

**Notice!**

After the basic configuration of an E-Series the system needs many hours (or even days) to initialize. In this phase the full performance is not available and in phase 1.5 formatting can fail.

Physical capacity [GB]

Information on the total capacity of the storage system.

Number of LUNs

You can change the number of LUNs.

**Notice!**

If you change the number of LUNs, the entire iSCSI system is reorganized and any sequences saved on the system are lost.

Therefore, before making changes, check the recordings and back up any important sequences.

Capacity for new LUNs [GB]

As 256 is the maximum number of LUNs of a storage array, the LUN size should not be set to a too small value. Otherwise no more LUNs can be created in the future, if an additional shelf is installed.

Target spare disks

Number of spare disks the user wants the system to have.

Actual spare disks

Number of spare disks which are currently in the system. This number can differ from the number above, for example, if the storage system is reconfigured manually or if disks are broken.

Initialization status (%)

Additional information is displayed during initialization. When initialization is complete (100%), you will also have the opportunity to delete all LUNs again.

RAID-DP (reliability focused)

Activate this option if you do not wish to use the specified RAID type RAID-4, but would prefer to use the more reliable RAID type RAID DP.

RAID 6 (reliability focused)

Select this option if you do not want to use the specified RAID type RAID 5, but would prefer to use the more reliable RAID type RAID 6.





Additional information

Displays additional information, for example information that the storage system is not configured correctly and that therefore no setup is possible.

Refer to

– *Adding a DSA E-Series iSCSI device manually, page 186*

13.25.6**Load Balancing dialog box**

Main window > **Devices** > Expand  > Expand  > Expand  > Right-click  > **Load Balancing...** command > **Load Balancing** dialog box

Prerequisite: Configure the **Automatic** recording mode.

Set the upper limits for the permitted bit rate and the number of simultaneous iSCSI connections for each iSCSI system. If these limits are exceeded, data is no longer being written to the iSCSI system and is lost.



For supported systems (for example Bosch RAID, NetApp, DLA), use the default values. For another device see the documentation of this device. Start testing with small values.

13.25.7 Moving an iSCSI system to another pool (Change pool...)





Main window > **Devices** > Expand  > Expand  > Expand  > 

You move a device from one pool to another within the same VRM device without any recording loss.

To move:

1. Right-click  /  /  and click **Change Pool ...**
The **Change pool** dialog box is displayed.
2. In the **New Pool:** list, select the desired pool.
3. Click **OK**.
The device is moved to the selected pool.

13.25.8 LUNs page

Main window > **Devices** > Expand  > Expand  > Expand  > Expand  > 

Allows you to add, remove, or format LUNs, and to view information on the LUNs.

Add

Click to display the **Add LUN** dialog box.

Remove

Click to remove the selected rows. To select a row, click the row header on the left side. Each row represents a LUN.

A message box is displayed.

Format LUN

Click to format the selected LUN. A message box is displayed.

Format

Click the check box to select the LUN and then click **Format LUN**.

LUN

Displays the name of the LUN.

Size [GB]

Displays the maximal capacity of the LUN.

Large LUN

Each cell displays whether this is a LUN larger than 2 TB or not.

State

Displays the state of the LUN.

Progress

Displays the progress of the formatting process.

Refer to

– *Pool page, page 176*

- Adding a LUN, page 192
- Adding VRM Devices via scan, page 166

13.25.9 Adding a LUN

Main window > **Devices** > Expand  > Expand  > Expand 

Usually the network scan adds the desired iSCSI devices with their targets and LUNs automatically. If your network scan did not work correctly or you want to configure your iSCSI device offline before it is actually integrated into your network, you configure a target in your iSCSI device and on this target you configure one or more LUNs.

You can add LUNs larger than 2 TB if the pool is enabled for large LUNs.

LUNs larger than 2 TB ("large LUNs") are not supported by the following devices:

- VRM devices earlier than 3.60
- VSG devices with firmware version earlier than 6.30
- Encoders with firmware version earlier than 6.30

BVMS prevents you to perform the following procedures:

- Add or move devices with firmware version earlier than 6.30 to a pool that allows large LUNs.
- Add or move devices that are currently not connected to the network, to a pool that allows large LUNs.
- Add or move an iSCSI device that contains large LUNs, to a pool that does not allow large LUNs.
- Allow large LUNs on a pool that contains devices with firmware version earlier than 6.30.
- Disable large LUNs on a pool with an iSCSI device that contains large LUNs.

Please move devices with firmware earlier than 6.30 to a pool that does not allow large LUNs.

To add:

1. If required, click to select **Allow LUNs larger than 2 TB**.

2. Right-click  and click **Scan Target**.

The target  is added.

3. Click the target.
The **LUNs** page is displayed.

4. Click **Add**.
The **Add LUN** dialog box is displayed.

5. Enter the desired LUN number and click **OK**.
The LUN is added as a new row in the table.
Repeat this step for each desired LUN.

Notes:

- To remove a LUN, click **Remove**.
The video data remains on this LUN.
- To format a LUN, click **Format LUN**.
All data on this LUN is removed!

Add LUN dialog box

Main window > **Devices** > Expand  > Expand  > Expand  > Expand  >  > Click **Add**

Allows you to add a LUN.

Id

Enter the ID of the desired LUN.

Refer to

- Pool page, page 176
- LUNs page, page 191

13.25.10 Formatting a LUN

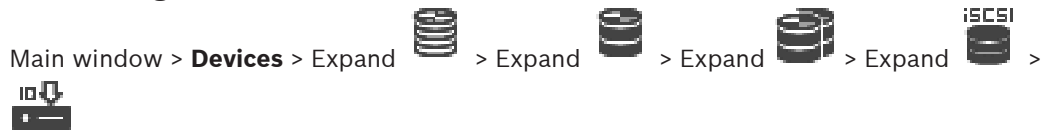

You format a LUN to prepare it for the first use.



Notice!

All data on the LUN is lost after formatting.

To configure:

1. Select the desired LUN and, in the **Format** column, click to check.
2. Click **Format LUN**.
3. Read the displayed message carefully and confirm the message if desired.
The selected LUN is formatted. All data on this LUN is lost.

Refer to

- LUNs page, page 191

13.25.11 iqn-Mapper dialog box

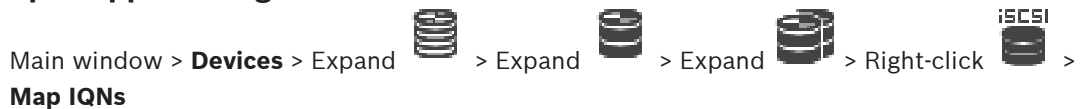

Allows you to start the IQN mapping process.

Refer to

- Adding VRM Devices via scan, page 166
- Configuring an iSCSI device, page 188

13.26 Video Streaming Gateway device page





This chapter provides information on how to configure the VSG device in your system.

Allows you to add and configure the following encoder types:

- Bosch encoders
- ONVIF encoders
- JPEG encoders
- RTSP encoders

To add VSG devices via scan:

1. Right-click  and click **Scan for Video Streaming Gateways**.
The **BVMS Scan Wizard** dialog box is displayed.
2. Select the required VSG devices, select the desired VRM pool and click **Assign** to assign them to the VRM pool.
3. Click **Next >>**.
The **Authenticate Devices** dialog box of the wizard is displayed.
4. Type in the password for each device that is protected by a password.
Password check is performed automatically, when you do not enter a further character in the password field for a few seconds or you click outside the password field.
If the passwords of all devices are identical, you can enter it in the first **Password** field.
Then right-click this field and click **Copy cell to column**.

In the **Status** column, the successful logons are indicated with .

The failed logons are indicated with .

5. Click **Finish**.

The device is added to the Device Tree.

If you add a new VSG version 7.0 or higher, the **Secure connection** check box is selected by default.

To change secure or unsecure connection, use the **Edit Video Streaming Gateway** command and select or deselect the **Secure connection** check box.

Refer to

- *Editing a Video Streaming Gateway, page 195*
- *ONVIF page, page 225*

13.26.1**Adding a Video Streaming Gateway manually**

Main window > **Devices** > Expand  > 

You can add VSG devices to a VRM pool.

To add a VSG device manually:

1. Right-click  and click **Add Video Streaming Gateway**.
The **Add Video Streaming Gateway** dialog box is displayed.
2. Make the required settings for your VSG device.
3. Click **Add**.
⇒ The VSG device is added to the system. The cameras assigned to this VSG device are recorded.

Add Video Streaming Gateway dialog box

Right-click  > **Add Video Streaming Gateway** > **Add Video Streaming Gateway** dialog box

Name

Type in the desired display name for the device.

User name

Type in the user name used for authenticating at the device. Usually: service

Network address / port

Type the IP address of your device.

If the **Secure connection** check box is selected, the port changes automatically to HTTPS port. You can change the port number, if no default ports are used or the VSG instances are configured in a different order.

Default ports

VSG instance	rcpp port	HTTPS port
1	8756	8443
2	8757	8444
3	8758	8445
4	8759	8446
5	8760	8447
6	8761	8448
7	8762	8449

Password

Type in the valid password for authenticating at the device.

Show password

Click to enable that the entered password is displayed. Be careful that nobody can spy out this password.

Security

The **Secure connection** check box is selected by default, if HTTPS is supported. From VSG version 7.0, VSG supports secure connection.



Notice!

If you migrate to BVMS version 10.0 and higher, the **Secure connection** check box is not selected by default and the connection is unsecure (rcpp).

To change secure or unsecure connection, use the **Edit Video Streaming Gateway** command and select or deselect the **Secure connection** check box.

Test

Click to authenticate at the device with the credentials entered above.

Refer to

– *Editing a Video Streaming Gateway, page 195*

13.26.2

Editing a Video Streaming Gateway

Main window > **Devices** > Expand  > Expand  > Expand  > 

To change secure/unsecure connection:

1. Right- click .
2. Click **Edit Video Streaming Gateway**.
The **Edit Video Streaming Gateway** dialog box is displayed.

3. Select the **Secure connection** check box.
The used port changes automatically to the HTTPS port.
Or
deselect the **Secure connection** check box.
The used port changes automatically to the rcpp port.

**Notice!**

After upgrading to a newer version, we recommend changing to secure connection.

Refer to

- *Adding a Video Streaming Gateway manually, page 194*

13.26.3**Adding a camera to a VSG**

Main window > **Devices** > Expand  > Expand  > Expand  > 

You can add the following devices to your VSG:

- Encoders from Bosch
- ONVIF cameras
- JPEG cameras
- RTSP encoders

If you added VSG encoders offline, you can refresh their state.

To add:

1. Right-click , point to **Add Encoder/camera** and click the desired command.
2. Make the required settings in the dialog box for adding the device.
3. Click **OK**.

The device is added.





To refresh:

- ▶ Right-click the desired encoder and click **Refresh state**.
The properties of the device are retrieved.

Refer to

- *Add Bosch Encoder dialog box, page 196*
- *Add ONVIF Encoder dialog box, page 197*
- *Add JPEG Camera dialog box, page 199*
- *Add RTSP Encoder dialog box, page 200*

13.26.4**Add Bosch Encoder dialog box**

Main window > **Devices** > Expand  > Expand  > Expand  > Right-click  > **Add Encoder/camera** > **Bosch Encoder** command

You can add an encoder from Bosch to your VSG device.

Name

Type in the desired display name for the device.

Network address

Type in the network address of the device.

Type

Displays the detected device type, if supported.

User name

Type in the user name used for authenticating at the device. Usually: service

Password

Type in the valid password for authenticating at the device.

Show password

Click to enable that the entered password is displayed. Be careful that nobody can spy out this password.

Test

Click to authenticate at the device with the credentials entered above.

Properties

Click to enable the desired features available for this device.





Audio	Click to activate audio if available for this device.
PTZ	Click to activate PTZ if available for this device.
Camera protocol	<p>TCP Used for transmission in the Internet and / or for lossless data transmission. Ensures that no data packet gets lost. Bandwidth requirement can be high. Use if the device is located behind a Firewall. Does not support multicast.</p> <p>UDP Used for connectionless and lightweight data transmission in private networks. Data packets can get lost. Bandwidth requirement can be low. Supports multicast.</p>
Use video input 1 - Use video input 4	Click to select the video inputs if you configure a multichannel device.

Refer to

- *Adding a camera to a VSG, page 196*

13.26.5

Add ONVIF Encoder dialog box

Main window > **Devices** > Expand  > Expand  > Expand  > Right-click  > **Add Encoder/camera** > **Add ONVIF Encoder** command

or

Main window > **Devices** > Right-click  > **Add ONVIF Encoder** command

You can add an ONVIF encoder to your VSG device or as a live only encoder. You must configure the used profile for recording and live in the Camera Table.

From BVMS 10.0, ONVIF encoder events can be retrieved from VSG or ONVIF encoder directly. If you add a new ONVIF encoder, the **retrieve ONVIF events from VSG (Profile S, T)** check box is selected by default and Profile T is supported.

The following features are only supported, if an ONVIF encoder is added to your system via a VSG device:

- If ONVIF encoder events are retrieved from VSG, default ONVIF events are already mapped.
- The Operator can switch relays on or off in the Operator Client.



Notice!

Retrieving ONVIF events from VSG is only available from VSG version 7.0. If you migrate to BVMS version 10.0, existing ONVIF encoder events are retrieved from ONVIF encoder directly. You have to update the VSG to version 7.0.

Name

Type in the desired display name for the device.

Network address / port

Type the network address of the device. If required, change the port number.

User name

Type in the user name used for authenticating at the device. Usually: service

Password

Type in the valid password for authenticating at the device.

Show password

Click to enable that the entered password is displayed. Be careful that nobody can spy out this password.

Test

Click to authenticate at the device with the credentials entered above.

Secure connection

You can activate the secure connection of live video transferred from an ONVIF encoder to your VSG device.

Note:

When activated, the user of Operator Client cannot switch a stream to UDP and to UDP multicast.

When activated, ANR does not work for the affected device.

When activated, encoder replay does not work on encoders with firmware earlier than 6.30.



Notice!

Port 443 is set by default. You can edit the port number to match the configured HTTPS port on the encoder.

The configured port number will not be remembered.

Properties

Device type	Displays the retrieved device type.
Manufacturer	Displays the retrieved manufacturer name.
Model	Displays the retrieved model name.
Firmware version	Displays the retrieved firmware version.

Auxiliary commands	If the check box is selected, auxiliary commands are supported.
Number of video input channels	Enter the number of desired video inputs.
Number of audio input channels	Enter the number of desired audio inputs.
Number of alarm inputs	Enter the number of desired alarm inputs.
Number of relays	Enter the number of desired relays.
Assigned Gateway channel(s)	Enter the number of desired gateway channels.
Camera protocol	Select the desired camera protocol.
Use video input {0}	Select the check box to use the appropriate video input.
ONVIF profile	If supported, select the profile you want to configure.



Notice!

The **Video Streaming Gateway settings** options are not available for ONVIF encoder, that are added as live only encoder.

Refer to

- *Adding a camera to a VSG, page 196*

13.26.6

Add JPEG Camera dialog box

Main window > **Devices** > Expand  > Expand  > Expand  > Right-click  >

Add Encoder/camera > **JPEG camera** command

You can add a JPEG camera to your VSG device.

Name

Type in the desired display name for the device.

URL

Enter the URL of your JPEG camera / RTSP camera.

For a JPEG camera from Bosch, type in the following string:

`http://<ip-address>/snap.jpg?jpegCam=<channel_no.>`

For an RTSP camera from Bosch, type in the following string:

`rtsp://<ip-address>/rtsp_tunnel`

User name

Type in the user name used for authenticating at the device. Usually: service

Password

Type in the valid password for authenticating at the device.

Show password

Click to enable that the entered password is displayed. Be careful that nobody can spy out this password.

Test

Click to authenticate at the device with the credentials entered above.





Properties

Number of video input channels	Enter the number of available video inputs if available.
Frame rate [ips]	Enter the desired frame rate.

Refer to

– *Adding a camera to a VSG, page 196*

13.26.7**Add RTSP Encoder dialog box**

Main window > **Devices** > Expand  > Expand  > Expand  > Right-click  > **Add Encoder/camera** > **RTSP camera** command

You can add an RTSP encoder to your VSG device.

Name

Type in the desired display name for the device.

URL

Enter the URL of your JPEG camera / RTSP camera.

For a JPEG camera from Bosch, type in the following string:

```
http://<ip-address>/snap.jpg?jpegCam=<channel_no.>
```

For an RTSP camera from Bosch, type in the following string:

```
rtsp://<ip-address>/rtsp_tunnel
```

User name

Type in the user name used for authenticating at the device. Usually: service

Password

Type in the valid password for authenticating at the device.

Show password

Click to enable that the entered password is displayed. Be careful that nobody can spy out this password.

Test

Click to authenticate at the device with the credentials entered above.



Properties

Number of video input channels	Enter the number of available video inputs if available.
---------------------------------------	--

Refer to



– *Adding a camera to a VSG, page 196*

13.26.8**Moving a VSG to another pool (Change pool)**

Main window > **Devices** > Expand  > Expand  >  >  >

You move a device from one pool to another within the same VRM device without any recording loss.

To move:

1. Right-click  /  /  and click **Change Pool ...**
The **Change pool** dialog box is displayed.
2. In the **New Pool:** list, select the desired pool.
3. Click **OK**.
The device is moved to the selected pool.

13.26.9

Configuring multicast (multicast tab)

Main window > **Devices** > Expand  > Expand  > Expand  > 

For each camera assigned to a Video Streaming Gateway device you can configure a multicast address and port.

To configure multicast:

1. Select the desired check box to enable multicast.
2. Type a valid multicast address and a port number.
3. If required, configure continuous multicast streaming.

Multicast tab

Main window > **Devices** > Expand  > Expand  > Expand  >  > **Network tab**
> **Multicast tab**

Allows you to configure multicast for the assigned cameras.

Enable

Click to enable multicast for this camera.

Multicast Address

Insert a valid multicast address (in the range 224.0.0.0 - 239.255.255.255).

Enter 1.0.0.0. A unique multicast address is automatically inserted based on the MAC address of the device.

Port

When a firewall is used, enter a port value that is configured as non-blocked port in the firewall.





Streaming

Click to enable continuous multicast streaming to the switch. This means that the multicast connection is not preceded by a RCP+ registration. The encoder streams always all data to the switch. The switch in return (if no IGMP multicast filtering is supported or configured) sends this data to all ports, with the result that the switch will flood.

You need streaming when using a non-Bosch device for receiving a multicast stream.

13.26.10

Configuring logging (advanced tab)

Main window > **Devices** > Expand  > Expand  > Expand  >  > **Service tab**
> **Advanced tab**

Allows you to activate logging for Video Streaming Gateway.

The log files are usually stored in the following path:

C:\Program Files (x86)\Bosch\Video Streaming Gateway\log

From VSG version 7.0, the log files are usually stored in the following path:

C:\ProgramData\Bosch\VSG\log

Note: If you upgrade to VSG 7.0 or newer, previous log files are automatically moved to this location.

Log files from older VSG versions are usually stored in the following path:

```
C:\Program Files (x86)\Bosch\Video Streaming Gateway\log
```

Advanced tab

RCP+ logging

Click to enable RCP+ logging.

Debug logging

Click to enable debug logging.

RTP logging

Click to enable RTP logging.

Retention time (days)

Select the desired number of days.

Complete memory dump file

Only select this check box if necessary, for example, if the Technical Customer Service team requests a complete summary of the main memory.

Telnet support

Select this check box if access with the Telnet protocol is to be supported. Only select if necessary.



Notice!

Extensive logging requires considerable CPU power and HDD capacity. Do not use extensive logging in continuous operation.

13.26.11

Starting ONVIF Camera Event Driver Tool from Configuration Client

Main window > **Devices** > Expand > Expand > Expand >

You can start the ONVIF Camera Event Driver Tool directly from the Configuration Client for the selected VSG.

Note: You can also start the tool from the Windows start menu.

The ONVIF Camera Event Driver Tool allows you to map ONVIF events to VSG BVIP events. You can connect to ONVIF cameras and retrieve the ONVIF events for mapping.

To start the ONVIF Camera Event Driver Tool from the Configuration Client:

1. Right-click the appropriate VSG.
2. Click **Start ONVIF Camera Event Driver Tool**.
The ONVIF Camera Event Driver Tool is displayed.



Notice!

The ONVIF Camera Event Driver Tool only supports secure connection to the VSG.

To use the ONVIF Camera Event Driver Tool:

See the [How to video](#).

13.27 Live Only page

Main window > **Devices** > Expand  > 

Allows you to add and configure encoders used for live only. You can add Bosch encoders and ONVIF network video transmitters.

To add, edit, and configure a live only ONVIF encoder, see *ONVIF page, page 225*.

Refer to

- *Adding a live only encoder, page 211*
- *Scanning for devices, page 75*
- *Bosch Encoder / Decoder / Camera page, page 209*
- *ONVIF page, page 225*
- *Configuring multicast, page 223*

13.27.1 Adding live only devices via scan

To add Bosch live only devices via scan:

1. Right-click  and click **Scan for Live Only Encoders**.
The **BVMS Scan Wizard** dialog box is displayed.
2. Select the desired check boxes for the devices that you want to add.
3. Click **Next >>**.
The **Authenticate Devices** dialog box of the wizard is displayed.
4. Type in the password for each device that is protected by a password.
Password check is performed automatically, when you do not enter a further character in the password field for a few seconds or you click outside the password field.
If the passwords of all devices are identical, you can enter it in the first **Password** field.
Then right-click this field and click **Copy cell to column**.



In the **Status** column, the successful logons are indicated with .

The failed logons are indicated with .

5. Click **Finish**.
The device is added to the Device Tree.

The  icon indicates an error that you need to take care of. Check the tool tip for more information about the specific error.

13.27.2 Adding an Encoder / Decoder manually

Main window > **Devices** > Expand  > Expand  > Right-click  > Click **Add Encoder** > **Add Encoder** dialog box
or

Main window > **Devices** > Right-click  > Click **Add Encoder** > **Add Encoder** dialog box
or

Main window > **Devices** > Right-click  > Click **Add Encoder** > **Add Encoder** dialog box
or





Main window > **Devices** > Expand  > Right-click  > Click **Add Decoder** > **Add Encoder** dialog box

Allows you to add an encoder or decoder manually. This is especially useful when you want to add any Video IP device from Bosch (only for VRM).

Notice:

If you add a Video IP encoder or decoder from Bosch with the **<Auto Detect>** selection, this device must be available in the network.

To add a Video IP device from Bosch:

1. Expand , expand , right-click .
Or
Right-click .
Or
Right-click .

2. Click **Add Encoder**.
The **Add Encoder** dialog box is displayed.
3. Enter the appropriate IP address.
4. In the list, select **<Auto Detect>**.
5. Click **OK**.
The device is added to the system.

The  icon indicates an error that you need to take care of. Check the tool tip for more information about the specific error.

Add Encoder dialog box

IP address:

Type in a valid IP address.

Encoder type: / Decoder type:

For a device with known device type, select the appropriate entry. It is not necessary that the device is available in the network.

If you want to add any Video IP device from Bosch, select **<Auto Detect>**. The device must be available in the network.

If you want to add a camera for offline configuration, select **<Single placeholder camera>**.

13.27.3 Providing the destination password for a decoder (Authenticate...)

Main window > **Devices** > Expand  > Expand  > Right-click  > Click **Authenticate...** > **Enter password** dialog box

To enable the access of a password protected encoder to a decoder, you must enter the password of the user authorization level of the encoder as the destination password in the decoder.

To provide:

1. In the **Enter user name** list, select destination password.
2. In the **Enter password for user** field, type in the new password.
3. Click **OK**.

⇒ The password is changed immediately on the device.

Refer to

- *Changing the password of an encoder / decoder (Change password / Enter password), page 140*

13.28**Local Storage page**

Main window > **Devices** > Expand  > 

Allows you to add and configure encoders with local storage.

To add local storage encoders via scan:

1. In the Device Tree right-click  and click **Scan for Local Storage Encoders**.
The **BVMS Scan Wizard** dialog box is displayed.
2. Select the desired check boxes for the devices that you want to add.
3. Click **Next >>**.
The **Authenticate Devices** dialog box of the wizard is displayed.
4. Type in the password for each device that is protected by a password.
Password check is performed automatically, when you do not enter a further character in the password field for a few seconds or you click outside the password field.
If the passwords of all devices are identical, you can enter it in the first **Password** field.
Then right-click this field and click **Copy cell to column**.

In the **Status** column, the successful logons are indicated with .

The failed logons are indicated with .

5. Click **Finish**.
The device is added to the Device Tree.

The  icon indicates an error that you need to take care of. Check the tool tip for more information about the specific error.

Refer to

- *Configuring multicast, page 223*
- *Adding a local storage encoder, page 211*
- *Bosch Encoder / Decoder / Camera page, page 209*
- *Scanning for devices, page 75*

13.29**Unmanaged Site page**

Main window > **Devices** > Expand  > 

You can add a video network device to the **Unmanaged Sites** item of the Device Tree.

It is assumed that all unmanaged network devices of an unmanaged site are located in the same time zone.

Site name

Displays the name of the site that was entered during creation of this item.

Description

Type in a description for this site.

Time zone

Select the appropriate time zone for this unmanaged site.

Refer to

- *Unmanaged site, page 25*
- *Adding an unmanaged site manually, page 206*
- *Importing unmanaged sites, page 206*
- *Configuring the time zone, page 207*

13.29.1 Adding an unmanaged site manually

Main window > **Devices** > 

To create:

1. Right-click  and then click **Add Unmanaged Site**.
The **Add Unmanaged Site** dialog box is displayed.
2. Type in a site name and a description.
3. In the **Time zone** list, select the appropriate entry.
4. Click **OK**.
A new unmanaged site is added to the system.

Refer to

- *Unmanaged site, page 25*
- *Unmanaged Site page, page 205*

13.29.2 Importing unmanaged sites

Main window > **Devices** > 

You can import a CSV file containing a configuration of a DVR or another BVMS that you want to import in your BVMS as an unmanaged site.

To import:

1. Right-click  and then click **Import Unmanaged Sites**.
2. Click the desired file and click **Open**.
One or more new unmanaged site is added to the system.
You can now add these unmanaged sites to the Logical Tree.
Note: If an error occurs and the file cannot be imported, an error message informs you accordingly.

13.29.3 Unmanaged Site page**Site name**

Displays the name of the site that was entered during creation of this item.

Description

Type in a description for this site.

Time zone



Select the appropriate time zone for this unmanaged site.

13.29.4 Adding an unmanaged network device

Main window > **Devices** >  > 

1. Right-click this item and then click **Add Unmanaged Network Device**.
The **Add Unmanaged Network Device** dialog box is displayed.
2. Select the desired device type.
3. Type in a valid IP address or hostname and credentials for this device.
4. Click **OK**.
A new **Unmanaged Network Device** is added to the system.
You can now add this unmanaged site to the Logical Tree.
Please note that only the site is visible in the Logical Tree but not the network devices belonging to this site.
5. Type in the valid user name for this network device if available.
6. Type in the valid password if available.

Add Unmanaged Network Device dialog box

Main window > **Devices** > Expand  > Right click  > Click **Add Unmanaged Network Device**

Device type:

Select the entry that is applicable for this device.

Available entries:

- **DIVAR AN / DVR**
- **DIVAR IP (AiO), BVMS**
- **Bosch IP camera / encoder**

Network address:

Type an IP address or hostname. If required, change the port number.

Note: If you use a SSH connection, enter the address in the following format:

ssh://IP or servername:5322

Security

The **Secure connection** check box is selected by default.



Notice!

If adding DVR and the **Secure connection** check box is selected, command and control connections are secure. Video data streaming is not secure.

User name:

Type the valid user name for this network device if available. See *Unmanaged site, page 25* for details.

Password:

Type the valid password if available. See *Unmanaged site, page 25* for details on user credentials.

Refer to

- *Unmanaged site, page 25*

13.29.5

Configuring the time zone

Main window > **Devices** > Expand  > 

You can configure the time zone of an unmanaged site. This is useful when a user of Operator Client wants to access an unmanaged site using a computer with Operator Client located in another time zone than this unmanaged site.

To configure the time zone:

- ▶ In the **Time zone** list, select the appropriate entry.

Refer to

- *Unmanaged Site page, page 205*

14 Bosch Encoder / Decoder / Camera page

This chapter provides information on how to configure the encoders and decoders in your system.











Notice!

BVMS Viewer does not support decoder devices.

To get detailed information on the encoder, decoder or camera settings, for example Video Content Analysis (VCA) or network settings, refer to the appropriate device manuals. The count of items below an entry is displayed in square brackets.

To configure an encoder:

Main window > **Devices** > Expand  > Expand  >  > 

or
Main window > **Devices** > Expand  > Expand  > Expand  > 

or
Main window > **Devices** >  > 

or
Main window > **Devices** >  > 





To configure a decoder:



Main window > **Devices** > Expand  > Expand  > 

See the Online Help for the  pages for details.

To configure a camera:

Main window > **Devices** > Expand  > Expand  >  > 

or
Main window > **Devices** > Expand  > Expand  >  >  > 



or
Main window > **Devices** > Expand  > Expand  > Expand  >  > 

or
Main window > **Devices** >  >  > 

or
Main window > **Devices** >  >  > 

- Click  to save the settings.

- Click  to undo the last setting.





- Click  to activate the configuration. Most of the settings on the encoder / decoder / camera pages are active immediately after you click . If you click another tab without clicking  and changes have occurred, two corresponding message boxes are displayed. Confirm them both if you want to save. To change the passwords of an encoder right-click the device icon and click **Change password...** To display the device in a Web browser right-click the device icon and click **Show webpage in browser**.

Note:

Depending on the selected encoder or camera, not all pages described here are available for each device. The wording used here for describing the field labels can deviate from your software.

- ▶ Click a tab to display the corresponding property page.

To add encoders via scan:

1. Right-click  and click **Scan for Encoders**. The **BVMS Scan Wizard** dialog box is displayed.
 2. Select the required encoders, select the desired VRM pool and click **Assign** to assign them to the VRM pool.
 3. Click **Next >>**. The **Authenticate Devices** dialog box of the wizard is displayed.
 4. Type in the password for each device that is protected by a password. Password check is performed automatically, when you do not enter a further character in the password field for a few seconds or you click outside the password field. If the passwords of all devices are identical, you can enter it in the first **Password** field. Then right-click this field and click **Copy cell to column**. 
- In the **Status** column, the successful logons are indicated with .
- The failed logons are indicated with .
5. Click **Finish**. The device is added to the Device Tree.

The  icon indicates an error that you need to take care of. Check the tool tip for more information about the specific error.

Refer to

- *Scanning for devices, page 75*

14.1**Adding an encoder to a VRM pool**

To add encoders to a VRM pool, see *Adding Encoders via scan, page 174*.

Refer to

- *Adding a device, page 123*

14.2 Adding a live only encoder

To add a live only encoder via scan, see *Adding live only devices via scan, page 203*.

Refer to

- *Adding a device, page 123*
- *Live Only page, page 203*

14.3 Adding a local storage encoder

To add local storage encoders via scan, see *Local Storage page, page 205*.

Refer to

- *Adding a device, page 123*
- *Local Storage page, page 205*

14.4 Adding a single placeholder camera

If you want to add and configure a camera that is currently offline, you can add a single placeholder camera instead. You can add the single placeholder camera to the logical tree, to maps and configure events and alarms.

To add a single placeholder camera

1. Right-click the device tree item where you want to add the placeholder camera.
2. Click **Add Encoder**.
The **Add Encoder** dialog box displays.
3. Type a respective IP address that is currently offline.
4. Select the encoder type **<Single placeholder camera>**.
5. Configure all appropriate settings for the placeholder camera.





To replace a single placeholder camera

1. Right-click the respective placeholder camera.
2. Click **Edit Encoder**.
The **Edit Encoder** dialog box displays.
3. Type the network address of the replacement camera.
4. Type the correct password of the replacement camera.
5. Click **OK**.
The **Updating Device Names** dialog box displays.
6. Click **OK**.

Note: When the device capabilities of the replacement camera are up to date, you have to check the settings you made in the cameras and recordings table.

14.5 Editing an Encoder

14.5.1 Encrypting live video (Edit Encoder)

Main window > **Devices** > Expand  > Expand  > Expand  > Click  > **Edit Encoder** dialog box

Main window > **Devices** > Expand  > Right click  > **Edit Encoder** dialog box

Main window > **Devices** > Expand  > Click  > **Edit Encoder** dialog box

You can activate the secure connection of live video transferred from an encoder to the following devices if HTTPS port 443 is configured on the encoder:

- Operator Client computer
- Management Server computer
- Configuration Client computer
- VRM computer
- Decoder

Note:

When activated, ANR does not work for the affected device.

When activated, encoder replay does not work on encoders with firmware earlier than 6.30.

Only encoder with firmware version 7.0 or later support secure UDP. When secure connection is activated in this case, the user of Operator Client can switch a stream to UDP and to UDP multicast.

To activate:





1. Select the check box **Secure connection**.
2. Click **OK**.
Secure connection is enabled for this encoder.

Refer to

- *Configuring multicast, page 223*
- *Edit Encoder / Edit Decoder dialog box, page 213*

14.5.2



Updating the device capabilities (Edit Encoder)

Main window > **Devices** > Expand  > Expand  > Expand  > Right-click  > Click **Edit Encoder** > **Edit Encoder** dialog box

or

Main window > **Devices** > Expand  > Right-click  > Click **Edit Encoder** > **Edit Encoder** dialog box

or

Main window > **Devices** > Expand  > Right-click  > Click **Edit Encoder** > **Edit Encoder** dialog box

or

Main window > **Devices** > Expand  > Expand  > Right-click  > Click **Edit Decoder** > **Edit Decoder** dialog box

After an upgrade of the device, you can update its device capabilities. A message text informs you whether the retrieved device capabilities match the device capabilities stored in BVMS.

To update:





1. Click **OK**.
A message box is displayed with the following text:
If you apply the device capabilities, the recording settings and the event settings for this device may change. Check these settings for this device.
2. Click **OK**.
The device capabilities are updated.

Refer to

- *Edit Encoder / Edit Decoder dialog box, page 213*

14.5.3

Edit Encoder / Edit Decoder dialog box

Main window > **Devices** > Expand  > Expand  > Expand  > Right-click  > Click **Edit Encoder** > **Edit Encoder** dialog box

or

Main window > **Devices** > Expand  > Right-click  > Click **Edit Encoder** > **Edit Encoder** dialog box

or

Main window > **Devices** > Expand  > Right-click  > Click **Edit Encoder** > **Edit Encoder** dialog box

or

Main window > **Devices** > Expand  > Expand  > Right-click  > Click **Edit Decoder** > **Edit Decoder** dialog box

Allows you to check and update the device capabilities of a device. On opening this dialog box the device is connected. The password is checked and the device capabilities of this device are compared with the device capabilities stored in BVMS.

Name

Displays the device name. When you add a Video IP device from Bosch, the device name is generated. If required change the entry.

Network address / port

Type the network address of the device. If required, change the port number.

User name

Displays the user name used for authenticating at the device.

Password

Type the valid password for authenticating at the device.

Show password

Click to enable that the entered password is displayed. Be careful that nobody can spy out this password.

Authenticate

Click to authenticate at the device with the credentials entered above.

Security

The **Secure connection** check box is selected by default.

If a secure connection is not possible, a message appears. Click to remove the checkmark.

The following decoders support secure connection:

- VJD 7000
- VJD 8000
- VIP XD HD



Notice!

The connection between a decoder and an encoder is only secure, if both are configured with secure connection.

Video stream

UDP: Enables encrypted multicast streaming for supported decoder devices.

TCP: Enables encrypted unicast streaming for supported decoder devices.

Note: If no multicast address is configured for an encoder, the decoder retrieves the stream by unicast.



Notice!

BVMS does not support Bosch cameras connected to a VSG.

BVMS only supports UDP encryption for platforms older than CPP13.

Device Capabilities

You can sort the displayed device capabilities per category or alphabetically.

A message text informs you whether the detected device capabilities match the current device capabilities.

Click **OK** to apply the changes of the device capabilities after an upgrade of the device.

Refer to

- *Encrypting live video (Edit Encoder), page 211*
- *Updating the device capabilities (Edit Encoder), page 212*

14.6

Managing the verification of authenticity

For activating the verification of authenticity on an encoder, you must perform the following steps:

- Configure the authentication on the encoder.
- Download a certificate from the encoder.
- Install this encoder certificate on the workstation used for authenticity verification.

Refer to

- *Verification of authenticity , page 214*

14.6.1

Verification of authenticity

The user of Operator Client can verify the authenticity of recordings. The authenticity of exports is automatically verified.

The administrator must follow these steps for ensuring an unbroken certificate chain. For large systems (>30 cameras) we recommend the following procedure:

- Let your issuing certificate authority (CA) issue a certificate for each encoder.
- Upload the issued certificate (including private key) in a secure way on each encoder.
- Install the CA certificate on the Operator Client workstations where you want to perform authenticity verification or on other computers where you want to perform exports.

For small systems (<30 cameras) we recommend the following procedure:

- Download the `HTTPS Server` certificate from each encoder.
- Install these certificates on the Operator Client workstations where you want to perform authenticity verification.

Ask the IT support of your company for details.

For activating the secure verification of authenticity, the administrator must perform the following steps:

- Activate the authentication on each desired camera.
- For large systems: Upload and assign the appropriate certificate to each desired camera.
- For small systems: Download a certificate from each encoder. Install the certificates allowing verification on a workstation.

Limitations

Firmware version 6.30 or later is required.

We recommend verifying the authenticity of maximum 4 cameras at the same time.

The user of Operator Client cannot verify the authenticity of live video.

Note: Do not change the certificate when recording is running. If you have to change the certificate, first stop the recording, change the certificate, and start recording again.

For verifying the authenticity of a recording, this recording is replayed in a background process with maximum speed. In networks with low bandwidth the playback can be slow. The verify process can then take as long as the time period selected for verifying. Example: You select a time period of 1 hour. The verifying process can last up to 1 hour.

The user can only verify that a recording is authentic. If the verification process is not successful, this does not necessarily mean that the video has been manipulated. Many other reasons can be responsible for the failure, for example a manual deletion. The user of Operator Client cannot distinct between an intended change of the recording or fraudulent manipulation.

Video authentication deals solely with methods of validating the authenticity of video. Video authentication does not deal with the transmission of video, or data, in any way.

The watermark feature for verifying authenticity in earlier BVMS versions is replaced. The new authenticity verification is automatically available after upgrade to the latest BVMS version.

Authenticity checks that were successful in the past, can now not be verified because these recordings do not contain the required extended information.

Verifying authenticity is not supported in the following cases:

- Transcoding
- Local recording
- VSG
- Digital Video Recorder
- Bosch Recording Station
- ANR

Refer to

- *Configuring the authentication, page 215*
- *Uploading a certificate, page 216*
- *Downloading a certificate, page 216*
- *Installing a certificate on a workstation, page 216*

14.6.2

Configuring the authentication

Main window > **Devices** > Expand  > Expand  > Expand  > 

or

Main window > **Devices** > Expand  > 





You can activate the verification of authenticity on an encoder.

To configure:

1. Click **Camera**, and then click **Video Input**.
2. In the **Video authentication** list, select **SHA-256**.
3. In the **Signature intervals** list, select the desired value.
A small value increases the security, a large value reduces the load for the encoder.

4. Click  .

14.6.3 Uploading a certificate

Main window > **Devices** > Expand  > Expand  > Expand  > 

or

Main window > **Devices** > Expand  > 





You can upload a derived certificate to an encoder.

To upload:

1. Click **Service**, and then click **Certificates**.
2. Click **Upload certificate**.
3. Select the appropriate file containing the certificate for this encoder. This file must contain the private key, for example *.pem.
Ensure a secure data transmission.
4. Click **Open**.
5. In the **Usage** list, select **HTTPS server** to assign the uploaded certificate to the **HTTPS server** entry.

6. Click  .

14.6.4 Downloading a certificate

Main window > **Devices** > Expand  > Expand  > Expand  > 

or

Main window > **Devices** > Expand  > 

You can download a certificate from an encoder.

To download:

1. Click **Service**, and then click **Certificates**.
2. Select the desired certificate and click the *Save* icon.
3. Select the appropriate directory for saving the certificate file.
4. Rename the file extension of the certificate file to *.cer.

You can now install this certificate on the workstation where you want to verify authenticity.

14.6.5 Installing a certificate on a workstation

You can install the certificate that you have downloaded from an encoder, on a workstation where you want to perform authenticity verification.

1. On the workstation, start *Microsoft Management Console*.
2. Add the *Certificates snap-in on this computer with the Computer account option* selected.
3. Expand *Certificates (Local computer)*, expand *Trusted Root Certification Authorities*.
4. Right-click *Certificates*, point to *All Tasks* and then and click *Import...*
The *Certificate Import Wizard* is displayed.
The *Local Machine* option is preselected and cannot be changed.
5. Click *Next*.
6. Select the certificate file that you have downloaded from the encoder.
7. Click *Next*.
8. Leave the settings unchanged and click *Next*.
9. Leave the settings unchanged and click *Finish*.

14.7 Providing the destination password for a decoder (Authenticate...)

Main window > **Devices** > Expand  > Expand  > Right-click  > Click **Authenticate...** > **Enter password** dialog box

To enable the access of a password protected encoder to a decoder, you must enter the password of the user authorization level of the encoder as the destination password in the decoder.





To provide:

1. In the **Enter user name** list, select destination password.
 2. In the **Enter password for user** field, type in the new password.
 3. Click **OK**.
- ⇒ The password is changed immediately on the device.

Refer to

- *Changing the password of an encoder / decoder (Change password / Enter password), page 217*

14.8 Changing the password of an encoder / decoder (Change password / Enter password)

Main window > **Devices** > Expand  > Expand  >  > 

or

Main window > **Devices** >  > 

or

Main window > **Devices** >  > 

or

Main window > **Devices** > Expand  > Expand  > 

Define and change a separate password for each level. Enter the password (19 characters maximum; no special characters) for the selected level.

To change the password:

1. Right-click  and click **Change password...**
The **Enter password** dialog box is displayed.
 2. In the **Enter user name** list, select the desired user for which you want to change the password.
 3. In the **Enter password for user** field, type in the new password.
 4. Click **OK**.
- ⇒ The password is changed immediately on the device.

A password prevents unauthorized access to the device. You can use different authorization levels to limit access.

Proper password protection is only guaranteed when all higher authorization levels are also protected with a password. Therefore, you must always start from the highest authorization level when assigning passwords.

You can define and change a password for each authorization level if you are logged into the “service” user account.

The device has three authorization levels: service, user, and live.

- service is the highest authorization level. Entering the correct password gives access to all the functions and allows all configuration settings to be changed.
- user is the middle authorization level. At this level you can operate the device, play back recordings, and also control camera, for example, but you cannot change the configuration.
- live is the lowest authorization level. At this level you can only view the live video image and switch between the different live image displays.

For a decoder the following authorization level replaces the live authorization level:

- destination password (only available for decoders)
Used for access to an encoder.

Refer to

- *Providing the destination password for a decoder (Authenticate...), page 217*

14.9

Moving an encoder to another pool (Change Pool)

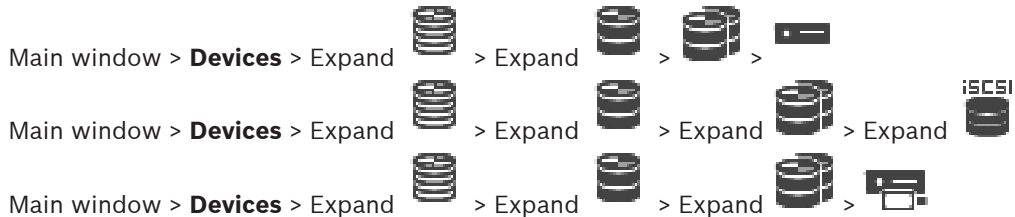

You move a device from one pool to another within the same VRM device without any recording loss.

To move:

1. Right-click / / and click **Change Pool ...**
The **Change pool** dialog box is displayed.
2. In the **New Pool:** list, select the desired pool.
3. Click **OK**.
The device is moved to the selected pool.

Change pool dialog box

Allows you to change the pool assignment of a device.

Current Pool:

Displays the number of the pool which the selected device is currently assigned to.

New Pool:

Select the desired pool number.

14.10

Recovering recordings from a replaced encoder (Associate with recordings of predecessor)



If replacing a defective encoder, the recordings of the replaced encoder are available for the new encoder when selecting the new encoder in the Operator Client.



Notice!



An encoder can only be replaced by an encoder with the same amount of channels.

To recover recordings from a replaced encoder



Notice!

Do not use the **Edit Encoder** command.

1. Right-click  > **Associate with recordings of predecessor ...** command.
2. The **Associate with recordings of predecessor ...** dialog box is displayed.
3. Type in the network address and a valid password for the new device.
4. Click **OK**.
5. Click  to save the settings.
6. Click  to activate the configuration.

Associate with recordings of predecessor ... dialog box

Allows you to recover recordings from a replaced encoder. After configuring the settings in the dialog box, the recordings of the replaced encoder are available for the new encoder when selecting the new encoder in the Operator Client .

Network address / port

Type the network address of the device.

User name

Displays the user name used for authenticating at the device.

Password

Type the valid password for authenticating at the device.

Authenticate





Click to authenticate at the device with the credentials entered above.

14.11

Configuring encoders / decoders

14.11.1

Configuring the storage media of an encoder

Main window > **Devices** > Expand  > Expand  >  >  > **Advanced Settings**
 > **Recording Management**

Note: Ensure that the desired cameras of this encoder are added to the Logical Tree.

You must configure the storage media of an encoder to use the ANR function.

Note: If you want to configure the storage media of an encoder that has already been added to your system and is recorded via VRM, ensure that secondary recording is stopped:

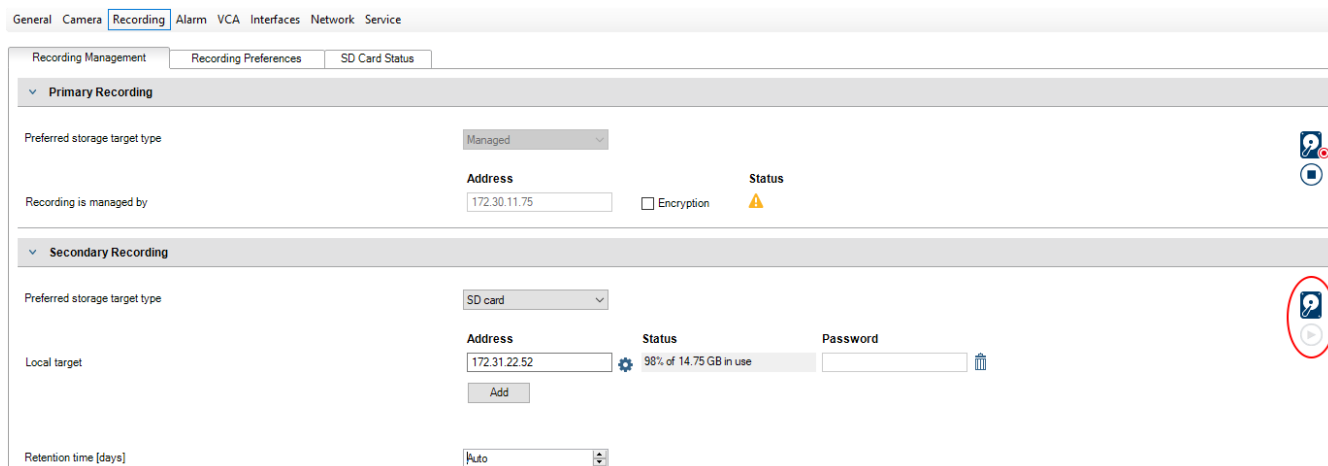

The ANR function only works on encoders with firmware version 5.90 or later. Not all encoder types support ANR even if the correct firmware version is installed.

To configure the storage media of an encoder:

1. Under **Secondary Recording**, in the **Preferred storage target type** list, select the storage media. Depending on the device type, different media are available.
2. If required, click the ... button to format the storage media.
After the successful formatting process, the storage media is ready for use with the ANR function.
3. Configure the ANR function for this encoder on the **Cameras and recording** page.

Refer to

- *Recording Management page, page 222*
- *Configuring the ANR function, page 287*

14.11.2

Configuring multiple encoders / decoders

Main window

You can modify the following properties of multiple encoders and decoders at once:

- Device passwords
- IP addresses
- Display names
- Subnet mask
- Gateway ID
- Firmware versions

To select multiple devices:

- ▶ Select the required devices by pressing the CTRL- or the SHIFT-key.

To select all available devices:

- ▶ Click the  **Select all** command.

To change the password for multiple devices:

1. On the Main window **Devices** click the  **Change device passwords** command.
Or
on the **Hardware** menu, click **Change device passwords...**
The **Change device passwords** dialog box is displayed.
2. Select the required devices.
3. Right-click the selected devices.
4. Click **Edit password...** The **Changing passwords** dialog box is displayed.
5. Make the appropriate settings.

**Notice!**

You can only select the password types that are available for all selected devices.

To configure multiple display names:

1. On the **Hardware** menu, click **Change device IP and network settings...**
The **Change device IP and network settings** dialog box is displayed.
2. Select the required devices.
3. Right-click the selected devices.
4. Click **Set Display Names...**
The **Set Display Names** dialog box is displayed.
5. Make the appropriate settings.

To configure multiple IP addresses:**Notice!**

Changing the IP address of an IP device can make it unreachable.

1. On the **Hardware** menu, click **Change device IP and network settings...**
The **Change device IP and network settings** dialog box is displayed.
2. Select the required devices.
3. Right-click the selected devices.
4. Click **Set IP addresses...**
The **Set IP Addresses** dialog box is displayed.
5. Make the appropriate settings.

To change subnet mask / gateway ID for multiple devices:

1. Click in the required field of one of the devices you want to change the value.
2. Type the appropriate value.
3. Select all required devices.
4. Right-click the required field of the device you already changed the value.
5. Click the **Copy Cell to** command and the **Selection in Column** command.
Or click the **Complete Column** command, if required.

**Notice!**

You can also copy complete rows to change IP addresses, display names, subnet masks and gateway IDs for multiple devices.

To update firmware for multiple devices:

1. On the **Hardware** menu, click **Update device firmware...** .
The **Update device firmware** dialog box is displayed.
2. Select the required devices.
3. Click the **Update Firmware** command.
4. Select the file containing the update.
5. Click **OK**.

Operation Result

Displays the appropriate state for the affected devices.

14.11.3**Configuring failover recording mode on an encoder**

Main window > **Devices** > Expand  > Expand  >  > 

Prerequisites: On the **Pool** page, in the **Recording preferences mode** list, select **Failover**. If **Automatic** is selected, the settings are performed automatically and cannot be configured.

If you want to use a secondary target for both automatic or failover mode: On the **Pool** page, in the **Secondary target usage** list, select **On**.

It is recommended to configure at least 2 iSCSI devices for failover mode.

To configure:

1. Click **Advanced Settings**.
2. Click **Recording Preferences**.
3. Under **Primary target**, select the entry for the required target. All storage systems entered under **Storage Systems** will be shown in the list.
4. Under **Secondary target**, select the entry for the required target. All storage systems entered under **Storage Systems** are displayed in the list.
The changes are active immediately. An activation is not required.

Related Topics

- *Configuring automatic recording mode on a pool, page 177*

14.11.4**Recording Management page**

Active recordings are indicated by

Point to the icon. Detailed information about the active recordings are displayed.

Recordings manually managed

The recordings are managed locally on this encoder. All relevant settings must be carried out manually. The encoder / IP camera acts as a live only device. It is not be removed from VRM automatically.

Recording 1 managed by VRM

The recordings of this encoder are managed by the VRM system.

Dual VRM

Recording 2 of this encoder is managed by a secondary VRM.

iSCSI Media tab

Click to display the available iSCSI storage connected to this encoder.

Local Media tab

Click to display the available local storage on this encoder.

Add

Click to add a storage device to the list of managed storage media.

Remove

Click to remove a storage device from the list of managed storage media.

Refer to

– *Configuring the storage media of an encoder, page 219*

14.11.5

Recording preferences page

The **Recording preferences** page is displayed for each encoder. This page only appears if a device is assigned to a VRM system.

Primary target

Only visible if the **Recording preferences mode** list on the **Pool** page is set to **Failover**. Select the entry for the required target.

Secondary target

Only visible if the **Recording preferences mode** list on the **Pool** page is set to **Failover** and if the **Secondary target usage** list is set to **On**. Select the entry for the required target for configuring failover mode.

Refer to

– *Pool page, page 176*

14.12

Configuring multicast

For each assigned camera you can configure a multicast address with port.

To configure multicast:

1. Select the desired check box to enable multicast.
2. Type a valid multicast address and a port number.
3. If required, configure continuous multicast streaming.

Multicast tab

Main window > **Devices** >  > 

or

Main window > **Devices** >  > 

or

Main window > **Devices** > Expand  > Expand  >  > 

> **Network** tab > **Multicast** tab

Allows you to configure multicast for the assigned cameras.

Enable

Click to enable multicast for this camera.

Multicast Address

Insert a valid multicast address (in the range 224.0.0.0 - 239.255.255.255).

Enter 1.0.0.0. A unique multicast address is automatically inserted based on the MAC address of the device.

Port

When a firewall is used, enter a port value that is configured as non-blocked port in the firewall.

Streaming

Click to enable continuous multicast streaming to the switch. This means that the multicast connection is not preceded by a RCP+ registration. The encoder streams always all data to the switch. The switch in return (if no IGMP multicast filtering is supported or configured) sends this data to all ports, with the result that the switch will flood.

You need streaming when using a non-Bosch device for receiving a multicast stream.

**Notice!**

Multicast streams are only secure, if the encoder has firmware version 7.0 or later and the **Secure connection** check box is selected.

Refer to

- *Encrypting live video (Edit Encoder), page 211*

15 ONVIF page

Main window > **Devices** > Expand  > 

Main window > **Devices** > Expand  > Expand  > Expand  > Expand  > 

Refer to

- *Video Streaming Gateway device page, page 193*
- *Live Only page, page 203*

15.1 Adding an live only ONVIF device via scan

To add live only ONVIF devices via scan:

1. Right-click  and click **Scan for Live Only ONVIF Encoders**.
The **BVMS Scan Wizard** dialog box is displayed.
2. Select the desired check boxes for the devices that you want to add.
3. Click **Next >>**.
The **Authenticate Devices** dialog box of the wizard is displayed.
4. Type in the password for each device that is protected by a password.
Password check is performed automatically, when you do not enter a further character in the password field for a few seconds or you click outside the password field.
If the passwords of all devices are identical, you can enter it in the first **Password** field.
Then right-click this field and click **Copy cell to column**.

In the **Status** column, the successful logons are indicated with .

The failed logons are indicated with .

5. Click **Finish**.
The device is added to the Device Tree.

15.2 ONVIF Encoder page

Main window > **Devices** > Expand  > Expand  > Expand  > Expand  >  > **ONVIF Encoder** tab

or

Main window > **Devices** > Expand  >  > **ONVIF Encoder** tab
Displays information on a live only ONVIF encoder added to your BVMS.

Name

Displays the name of the ONVIF device. You can rename it in the Device Tree directly.

Network Address

Displays the IP address of the device.

Manufacturer

Displays the manufacturer name.

Model

Displays the model name.

Video Inputs

Enter the number of cameras connected to this encoder.

Audio Inputs

Enter the number of audio inputs connected to this encoder.

Alarm Inputs

Enter the number of alarm inputs connected to this encoder.

Relays

Enter the number of relays connected to this encoder.

Refer to

- *ONVIF Encoder Events page, page 226*
- *Adding a live only encoder, page 211*
- *Configuring an ONVIF mapping table, page 230*

15.3**ONVIF Encoder Events page**

From BVMS 10.0, ONVIF encoder events can be retrieved from VSG or ONVIF encoder directly. If you add a new ONVIF encoder, the **retrieve ONVIF events from VSG (Profile S, T)** check box is selected by default and Profile T is supported.

The following features are only supported, if an ONVIF encoder is added to your system via a VSG device:

- If ONVIF encoder events are retrieved from VSG, default ONVIF events are already mapped.
- The Operator can switch relays on or off in the Operator Client.

**Notice!**

Retrieving ONVIF events from VSG is only available from VSG version 7.0. If you migrate to BVMS version 10.0, existing ONVIF encoder events are retrieved from ONVIF encoder directly. You have to update the VSG to version 7.0.

Main window > **Devices** > Expand  > Expand  > Expand  > Expand  >  > **ONVIF Encoder Events** tab

or

Main window > **Devices** > Expand  >  > **ONVIF Encoder Events** tab

You have to map ONVIF events to BVMS events, if ONVIF encoder events are retrieved from ONVIF encoder directly. This ensures that you later can configure ONVIF events as BVMS alarms.

**Notice!**

If ONVIF encoder events are retrieved from VSG, default ONVIF events are already mapped.

Mapping Table

You can create or edit a Mapping Table.

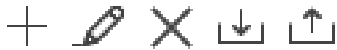

Click to display the **Add Mapping Table** dialog box.

Click to display the **Rename Mapping Table** dialog box.

Click to remove the Mapping Table with all rows.

Click or to import or export an ONVIF Mapping Table.

Events and Alarms

Select a BVMS event for mapping with an ONVIF event.

Add row

Click to add a row to the Mapping Table.

When multiple rows are available, an event occurs if one row is true.

Remove row

Click to remove the selected row from the Mapping Table.

ONVIF Topic

Type in or select a string, for example:

```
tns1:VideoAnalytics/tnsaxis:MotionDetection
```

ONVIF Data Name

Type in or select a string.

ONVIF Data Type

Type in or select a string.

ONVIF Data Value

Type in or select a string or number.

If ONVIF events are retrieved from VSG, the following events are mapped to VSG by default:

- **Global Change - Detected**
- **Global Change - Not detected**
- **Motion Detection - Motion Detected**
- **Motion Detection - Motion Stopped**
- **Reference Image Check - Deadjusted**
- **Reference Image Check - Adjusted**
- **Video Loss - Video Signal Lost**
- **Video Loss - Video Signal OK**
- **Video Loss - Video Signal State Unknown**
- **Video Signal Too Blurry - Video signal OK**
- **Video Signal Too Blurry - Video signal not OK**
- **Video Signal Too Bright - Video Signal OK**
- **Video Signal Too Bright - Video Signal Not OK**
- **Video Signal Too Dark - Video Signal OK**
- **Video Signal Too Dark - Video Signal Not OK**
- **Video Signal Too Noisy - Video Signal OK Video Signal Not OK**
- **Relay State - Relay Opened**

- **Relay State - Relay Closed**
- **Relay State - Relay Error**
- **Input State - Input Opened**
- **Input State - Input Closed**
- **Input State - Input Error**

Refer to

- *Starting ONVIF Camera Event Driver Tool from Configuration Client, page 202*
- *ONVIF event mapping, page 42*
- *Configuring an ONVIF mapping table, page 230*

15.3.1

Adding and removing an ONVIF profile

Main window > **Devices** > Expand  > Expand  > Expand  > Expand  >  > **ONVIF Encoder Events** tab

or

Main window > **Devices** > Expand  >  > **ONVIF Encoder Events** tab

You can add, remove or change ONVIF profiles for a selected encoder.

To add:

1. Click **Add...**
2. In the **Add Profile** dialog box, type a name for the profile.
3. Click **Next >**.
4. In the next dialog box, select the desired camera.
5. Click **Next >**.
6. In the next dialog box, select the desired non-recording encoder profile.
7. Click **Save**.

The new profile is saved.

The settings of this profile are filled with the values from the selected encoder profile.

You can change these values if required.

To remove:

- ▶ In the list, select a profile and click **Remove**.

To change:

1. In the list, select a profile.
2. Change the settings as required.

15.3.2

Exporting an ONVIF mapping table file

Main window > **Devices** > Expand  > Expand  > Expand  > Expand  >  > **ONVIF Encoder Events** tab

or

Main window > **Devices** > Expand  >  > **ONVIF Encoder Events** tab

You can export an ONVIF Mapping Table as a file (OMF file). The Mapping Table is saved for the selected encoder model.

To export:

1. Click .
2. Type in a filename and click **Save**.

The ONVIF Mapping Table is exported as OMF file for the selected encoder model.

Refer to

- *ONVIF Encoder Events page, page 226*

15.3.3 Importing an ONVIF mapping table file

Main window > **Devices** > Expand  > Expand  > Expand  > Expand  >
 > **ONVIF Encoder Events** tab

or

Main window > **Devices** > Expand  >  > **ONVIF Encoder Events** tab

You can import an ONVIF Mapping Table available as a file (OMF file).

Released ONVIF Mapping files are stored in the following directory of Configuration Client:

- %programdata%\Bosch\VMS\ONVIF







If the same Mapping Table name is already imported, an error message is displayed.

If a newer version of this file is imported, a warning is displayed. Click **OK** if you want to import this file. Otherwise click **Cancel**.

To import:

1. Click .
2. Select the desired file and click **Open**.
The **Import Mapping Table** dialog box is displayed.
3. Make the appropriate settings.
4. Click **OK**.

Import Mapping Table dialog box

Main window > **Devices** > Expand  > Expand  > Expand  > Expand  >
 > **ONVIF Encoder Events** tab > 

or

Main window > **Devices** > Expand  >  > **ONVIF Encoder Events** tab > 

Manufacturer

Displays the manufacturer name this Mapping Table is valid for.

Model

Displays the model name this Mapping Table is valid for.

Description

Displays further information for example on tested camera models.

Mapping Table name

Displays the name of the Mapping Table. Change this name if it is already in use in BVMS.

You can select one of the following options to decide to which ONVIF encoders you want to apply the Mapping Table.

Apply only to selected ONVIF encoder

Apply to all ONVIF encoders of the listed models

Apply to all ONVIF encoders of the manufacturer

Existing ONVIF event mapping is continued. You cannot import OMT files from earlier BVMS versions.

15.3.4 Configuring an ONVIF mapping table

Main window > **Devices** > Expand  > Expand  > Expand  > Expand  >  > **ONVIF Encoder Events** tab

or

Main window > **Devices** > Expand  >  > **ONVIF Encoder Events** tab

You configure Mapping Tables for mapping ONVIF events to BVMS events.

You configure a Mapping Table for all ONVIF encoders of the same model or all ONVIF encoders from the same manufacturer.

Click  to update ONVIF encoders that were added offline with the event mapping of an already added ONVIF encoder with the same manufacturer and/or model name.

For multichannel encoders you can configure the event sources, for example a specific camera or a relay.

To create a Mapping Table:

1. Click  .
The **Add Mapping Table** dialog box is displayed.
2. Type in a name for the Mapping Table.
3. In the **Manufacturer** and the **Model** lists, select the entries if desired.
When you select **<none>** in both lists, the event mapping is only valid for this device.
When you select **<none>** in the **Model** list and the manufacturer name in the **Manufacturer** list, the event mapping is valid for all devices with the same manufacturer.
When you select the available entries in both lists, the event mapping is valid for all devices with the same manufacturer and model.
4. Click **OK**.
You can now edit the Mapping Table, for example add a row to the **Motion Detected** event.

To edit a Mapping Table:

1. Click  .
The **Rename Mapping Table** dialog box is displayed.
2. Change the desired entries.

To add or remove event mappings:

1. In the **Mapping Table** list, select the desired name.
2. To add a row: Click **Add row**.
3. In the row, select the desired entries.
When multiple rows are available, an event is triggered when only one of the rows is true.





4. To remove a row: Click **Remove row**.

To remove a Mapping Table:







1. In the **Mapping Table** list, click the name of the event mappings that you want to remove.

2. Click .

To configure an event source:

1. Expand  and click  or  or .
2. Click the **ONVIF Event Source** tab.
3. In the **Trigger Event** column, activate the event configured in this row.
4. Select the desired event definitions.

Add / Rename ONVIF Mapping Table dialog box

Main window > **Devices** > Expand  > Expand  > Expand  > Expand  >  > **ONVIF Encoder Events** tab >  or 

or

Main window > **Devices** > Expand  >  > **ONVIF Encoder Events** tab >  or 

Allows you to add a Mapping Table. If this Mapping Table shall serve as a template for future ONVIF encoders of the same manufacturer and model, select the correct entries.

Mapping Table name

Type in name for easy identification.

Manufacturer

Select an entry if required.





Model

Select an entry if required.



Refer to

- *Enabling logging for ONVIF events, page 354*
- *ONVIF event mapping, page 42*
- *ONVIF Encoder Events page, page 226*
- *ONVIF Event Source page, page 243*

15.4 ONVIF Configuration page

Main window > **Devices** > Expand  > Expand  > Expand  > Expand  >  > **ONVIF Configuration** tab

or

Main window > **Devices** > Expand  >  > **ONVIF Configuration** tab

You can select multiple ONVIF encoders and change settings on the **Video Encoder Profile** page. The changed settings are valid for all selected devices. This page is only available for ONVIF encoders.







Notice!

Limitations of ONVIF configuration

Settings which you perform on these pages, are possibly not executed correctly because they are not supported by your camera. Supported ONVIF cameras were tested only with default settings.

15.4.1

Unit Access

Main window > **Devices** > Expand  > Expand  > Expand  > Expand  >  > **ONVIF Configuration** tab > **Main Settings** tab > **Unit Access** tab

or

Main window > **Devices** > Expand  >  > **ONVIF Configuration** tab > **Main Settings** tab > **Unit Access** tab

Manufacturer

Displays the manufacturer name of the selected encoder.

Model

Displays the model name of the selected encoder.

Note: If you want to export any event mappings into a ONVIF Mapping file select this model name as file name.

Hardware ID

Displays the hardware ID of the selected encoder.

Firmware version

Displays the firmware version of the selected encoder.

Note: Please ensure with the BVMS compatibility list whether the firmware version is correct.

Serial number

Displays the serial number of the selected encoder.

MAC address

Displays the MAC address of the selected encoder.





ONVIF version

Displays the ONVIF version of the selected encoder.



For BVMS, the ONVIF version 2.0 is required.

15.4.2

Date / Time

Main window > **Devices** > Expand  > Expand  > Expand  > Expand  >  > **ONVIF Configuration** tab > **Main Settings** tab > **Date/Time** tab

or

Main window > **Devices** > Expand  >  > **ONVIF Configuration** tab > **Main Settings** tab > **Date/Time** tab

Time zone

Select the time zone in which the system is located.





If there are multiple devices operating in your system or network, it is important to synchronize their internal clocks. For example, it is only possible to identify and correctly evaluate simultaneous recordings when all devices are operating on the same time.

1. Enter the current date. Since the device time is controlled by the internal clock, it is not necessary to enter the day of the week – it is added automatically.
2. Enter the current time or click **Sync to PC** to apply the system time from your computer to the device.

Note:

It is important that the date/time is correct for recording. An incorrect date/time setting could prevent correct recording.

15.4.3 User Management

Main window > **Devices** > Expand  > Expand  > Expand  > Expand  >  > **ONVIF Configuration** tab > **Main Settings** tab > **User Management** tab

or

Main window > **Devices** > Expand  >  > **ONVIF Configuration** tab > **Main Settings** tab > **User Management** tab

These user settings are used for 3rd party applications such as direct Web Client access to encoders.

Following user roles for the access of 3rd party applications are supported:

- **Anonymous:** This role has unlimited access only to those devices where no users from other roles (**User, Operator, Administrator**) are registered. On the devices with at least one above mentioned user, the anonymous user has the right only to view time settings.
- **Administrator** (not supported by Configuration Client): This role has access to all application sections and features, the rights to reboot the device, reset settings and update firmware as well as create other users with different access rights.

The first user created on the device must be **Administrator**.

For differences in Operator's and User's default access rights of the **Operator** role and the **User** role, see the following table.

ONVIF Configuration Section or Feature	Operator	User
Identification	VIEW	HIDDEN
Time Settings	VIEW	VIEW
Network Settings	VIEW	VIEW
Users	HIDDEN	HIDDEN
Relays Settings	CHANGE	VIEW
Live Video (including rtsp-link)	CHANGE	CHANGE
Video Streaming	CHANGE	VIEW
Profiles	CHANGE	VIEW

CHANGE - Change current and create new settings.

VIEW - Settings are not hidden, but it is not permitted to change and create them.

HIDDEN - Certain settings or even the whole sections are hidden.

Users

Lists the available users of the device.

Password

Type in a valid password.

Confirm password

Confirm the typed in password.



Role

Select the desired role for the selected user. Access rights are adapted accordingly.

15.4.4**Video Encoder Profile page**

Main window > **Devices** > Expand  > Expand  > Expand  > Expand  >  > **ONVIF Configuration** tab > **Camera** tab > **Video Encoder Profile** tab

or

Main window > **Devices** > Expand  >  > **ONVIF Configuration** tab > **Camera** tab > **Video Encoder Profile** tab

Profiles are rather complex and include a number of parameters that interact with one another, so it is generally best to use the pre-defined profiles. Only change a profile if completely familiar with all the configuration options.

Profiles

Click the desired name.

Notice!

The profiles configured here can be selected in Configuration Client.



In the main window, click **Cameras and recording** and click  or .

The default setting '<Automatic>' can be changed to one of the listed and configured profiles

Note: Take care when using actively more than 1 profile of a single device that certain performance restrictions apply and possibly the camera automatically restricts the quality of a stream in overload situations.

Name

You can enter a new name for the profile here. The name is then displayed in the list of available profiles in the Active profile field.

Encoding

Select the desired codec.

Resolution

Select the desired resolution for the video image.

Quality

This parameter allows you to reduce the load on the channel by means of reducing the picture definition. The parameter is set with the help of the slider bar: The left most position corresponds to the highest picture definition, the right most - to the lowest load on the video channel.

Frame rate limit

Frame rate (frame per second) denotes how many frames per second are captured by the video camera connected to the device. This parameter is shown just for information.

If an encoding interval is provided the resulting encoded frame rate is reduced by the given factor.

Bit rate limit

The less the bit rate is, the less the final video file size. But when the bit rate is considerably reduced, the program will have to use stronger compression algorithms, which also reduces video quality.

Select the maximum output bit rate in kbps. This maximum data rate is not exceeded under any circumstances. Depending on the video quality settings for the I- and P-frames, this fact can result in individual images being skipped.

The value entered here should be at least 10% greater than the typical target data bit rate.

Encoding interval

Encoding interval (number of frames) denotes at which rate the frames coming from the camera are encoded. For example, when encoding the interval comprises 25, it means that 1 frame from 25 captured per second is encoded and transmitted to the user. The maximum value reduces the load on the channel but may cause skipping information from the frames that were not encoded. Reducing the encoding interval increases the frequency of picture update as well as the load on the channel.

GOP length

GOP length is possible to edit only in case the encoder is H.264 or H.265. This parameter denotes the length of the picture group between the two key frames. The higher this value is, the less the load to the network is, but the video quality is affected.

An entry of 1 indicates that I-frames are continuously generated. An entry of 2 indicates that every second image is an I-frame, and 3 only every third frame, and so on. The frames in between are encoded as P-frames or B-frames.

Session timeout

The RTSP session timeout for the related video stream.

The session timeout is provided as a hint for keeping RTSP session by a device.

Multicast - IP address

Enter a valid multicast address to be operated in multicast mode (duplication of the data stream in the network).

With a 0.0.0.0 setting, the encoder for the stream operates in multi-unicast mode (copying of data stream in device). The camera supports multi-unicast connections for up to five simultaneously connected receivers.

Duplication of data places a heavy demand on the CPU and can lead to impairment of the image quality under certain circumstances.

Multicast - Port

Select the RTP multicast destination port. A device may support RTCP. In this case the port value shall be even to allow the corresponding RTCP stream to be mapped to the next higher (odd) destination port number as defined in the RTSP specification.

Multicast - TTL

A value can be entered to specify how long the multicast data packets are active on the network. If multicast is to be run via a router, the value must be greater than 1.

**Notice!**

Multicast operation is only possible with the UDP protocol. The TCP protocol does not support multicast connections.



If the device is operated behind a Firewall, select TCP (HTTP port) as the transfer protocol. For use in a local network, select UDP.

15.4.5**Audio Encoder Profile**

Main window > **Devices** > Expand  > Expand  > Expand  > Expand  >

 > **ONVIF Configuration** tab > **Camera** tab > **Audio Encoder Profile** tab

or

Main window > **Devices** > Expand  >  > **ONVIF Configuration** tab > **Camera** tab > **Audio Encoder Profile** tab

Profiles are rather complex and include a number of parameters that interact with one another, so it is generally best to use the pre-defined profiles. Only change a profile if completely familiar with all the configuration options.

Encoding

Select the desired encoding for the audio source if available:

- **G.711 [ITU-T G.711]**
- **G.726 [ITU-T G.726]**
- **AAC [ISO 14493-3]**

Bit rate

Select the desired bit rate, for example 64 kbps, for transmitting the audio signal.

Sample rate

Enter the output sample rate in kHz, for example 8 kbps.

Session timeout

The RTSP session timeout for the related audio stream.



The session timeout is provided as a hint for keeping RTSP session by a device.

15.4.6**Imaging General**

Main window > **Devices** > Expand  > Expand  > Expand  > Expand  >

 > **ONVIF Configuration** tab > **Camera** tab > **Imaging General** tab

or

Main window > **Devices** > Expand  >  > **ONVIF Configuration** tab > **Camera** tab > **Imaging General** tab

Brightness

Adjust the image brightness to your working environment.

Color saturation

Adjust the color saturation in the image to make the reproduction of colors on your monitor as realistic as possible.

Contrast

You can adapt the contrast of the video image to your working environment.

Sharpness

Adjust the sharpness in the image.

A low value makes the picture less sharp. Increasing sharpness brings out more detail. Extra sharpness can enhance the details of license plates, facial features and the edges of certain surfaces but can increase bandwidth requirements.





IR cut-off filter

Select the state of the IR cut-off filter.



The AUTO state lets the exposure algorithm handle when the IR cut-off filter is switched.

15.4.7

Backlight Compensation

Main window > **Devices** > Expand  > Expand  > Expand  > Expand  >  > **ONVIF Configuration** tab > **Main Settings** tab > **Backlight compensation** tab

or

Main window > **Devices** > Expand  >  > **ONVIF Configuration** tab > **Main Settings** tab > **Backlight compensation** tab

Depending on the device model you can configure here parameters for the backlight compensation.

Mode

Select **Off** to switch off backlight compensation.





Select **On** to capture details in high-contrast and extremely bright-dark conditions.

Level



Enter or select the desired value.

15.4.8

Exposure

Main window > **Devices** > Expand  > Expand  > Expand  > Expand  >  > **ONVIF Configuration** tab > **Main Settings** tab > **Exposure** tab

or

Main window > **Devices** > Expand  >  > **ONVIF Configuration** tab > **Main Settings** tab > **Exposure** tab

Depending on the device model you can configure here parameters for the exposure.

Mode

Select **Auto** to enable the exposure algorithm on the device. The values in the following fields are used by the algorithm:

- **Priority**
- **Window**
- **Min. exposure time**
- **Max. exposure time**
- **Min. gain**
- **Max. gain**
- **Min. iris**

Select **Manual** to disable the exposure algorithm on the device. The values in the following fields are used by the algorithm:

- **Exposure time**

- **Gain**
- **Iris**

Priority

Configure the exposure priority mode (low noise/frame rate).

Window

Define a rectangular exposure mask.

Min. exposure time

Configure the minimum exposure time period [μ s].

Max. exposure time

Configure the maximum exposure time period [μ s].

Min. gain

Configure the minimum sensor gain range [dB].

Max. gain

Configure the maximum sensor gain range [dB].

Min. iris

Configure the minimum attenuation of input light affected by the iris [dB]. 0dB maps to a fully opened iris.

Max. iris

Configure the maximum attenuation of input light affected by the iris [dB]. 0dB maps to a fully opened iris.

Exposure time

Configure the fixed exposure time [μ s].

Gain



Configure the fixed gain [dB].

Iris

Configure the fixed attenuation of input light affected by the iris [dB]. 0dB maps to a fully opened iris.



15.4.9

Focus

Main window > **Devices** > Expand  > Expand  > Expand  > Expand  >

 > **ONVIF Configuration** tab > **Main Settings** tab > **Focus** tab

or

Main window > **Devices** > Expand  >  > **ONVIF Configuration** tab > **Main Settings** tab > **Focus** tab

Depending on the device model you can configure here parameters for the focus.

This page allows for moving the lens in an absolute, a relative or in a continuous way. Focus adjustments through this operation turn off the autofocus. A device with support for remote focus control usually supports control through this move operation. The focus position is represented with a certain numeric value. The state of the focus can be one of the following:

MOVING

OK

UNKNOWN

Additionally error information can be displayed, for example a positioning error indicated by the hardware.

Mode

Select **Auto** to enable the lens to automatically focus at any time according to the objects in the scene. The values in the following fields are used by the algorithm:

- **Near limit**
- **Far limit**

Select **Manual** to adjust the focus manually. The values in the following fields are used by the algorithm:

- **Default speed**

Default speed

Configure the default speed for focus move operation (when the speed parameter not is present).

Near limit





Configure the near limit for focus lens [m].

Far limit



Configure the far limit for focus lens [m].

15.4.10

Wide Dynamic Range

Main window > **Devices** > Expand  > Expand  > Expand  > Expand  >  > **ONVIF Configuration** tab > **Main Settings** tab > **Wide Dynamic Range** tab

or

Main window > **Devices** > Expand  >  > **ONVIF Configuration** tab > **Main Settings** tab > **Wide Dynamic Range** tab

Depending on the device model you can configure here parameters for the wide dynamic range.

Mode





Enter or select the desired value.

Level



Enter or select the desired value.

15.4.11

White balance

Main window > **Devices** > Expand  > Expand  > Expand  > Expand  >  > **ONVIF Configuration** tab > **Main Settings** tab > **White Balance** tab

or

Main window > **Devices** > Expand  >  > **ONVIF Configuration** tab > **Main Settings** tab > **White Balance** tab

Depending on the device model you can configure here parameters for the white balance.

Mode

Auto mode allows the camera to continually adjust for optimal color reproduction using an average reflectance method or in an environment with natural light sources.

In Manual mode the Red, Green, and Blue gain can be manually set to a desired position

It is only necessary to change the white point offset for special scene conditions:

- indoor light sources and for colored LED light illumination

- sodium vapor light sources (street lighting)
- for any dominant color in the image for example, the green of a football pitch or of a gaming table

R-gain

In Manual white balance mode, adjust the Red gain slider to offset the factory white point alignment (reducing Red, increases Cyan).

B-gain



In Manual white balance mode, adjust the Blue gain slider to offset the factory white point alignment (reducing Blue, increases Yellow).

15.4.12

Network Access

Main window > **Devices** > Expand  > Expand  > Expand  > Expand  >  > **ONVIF Configuration** tab > **Network** tab > **Network Access** tab

or

Main window > **Devices** > Expand  >  > **ONVIF Configuration** tab > **Network** tab > **Network Access** tab

Here you can configure various network settings.

Ethernet IPv4

DHCP

If a DHCP server is employed in the network for the dynamic assignment of IP addresses, you can activate acceptance of IP addresses automatically assigned to the encoder. BVMS uses the IP address for the unique assignment of the encoder. The DHCP server must support the fixed assignment between IP address and MAC address, and must be appropriately set up so that, once an IP address is assigned, it is retained each time the computer is restarted.

Subnet mask

Type in the appropriate subnet mask for the set IP address. If DHCP server is enabled, the subnet mask is automatically assigned.

Default gateway

If you want the module to establish a connection to a remote location in a different subnet, type in the IP address of the gateway here. Otherwise leave the field empty (0.0.0.0).

Ethernet IPv6

DHCP

Enter or select the desired value.

IP address

Displays the IPv6 address of the device, provided by the DHCP server.

Prefix length

Displays the prefix length of the device, provided by the DHCP server.

Default gateway

Displays the default gateway of the device, provided by the DHCP server.

Host name

Enter or select the desired value.

DNS

Using a DNS server, the device can resolve an address indicated as a name. Enter the IP address of the DNS server here.

NTP servers

Type in the IP address of the desired time server or let the DHCP server do this for you. The encoder can receive the time signal from a time server using various time server protocols, and then use it to set the internal clock. The module polls the time signal automatically once every minute. Enter the IP address of a time server here. This supports a high level of accuracy and is required for special applications.

HTTP ports

Select a different HTTP browser port if required. The default HTTP port is 80. If you want to allow only secure connections via HTTPS, you must deactivate the HTTP port.

Note: Not supported by BVMS.

HTTPS ports

Note: Not supported by BVMS.

If you want to grant access on the network via a secure connection, select an HTTPS port if necessary. The default HTTPS port is 443. Select the **Off** option to deactivate HTTPS ports; only unsecured connections will now be possible.

Default gateway

Enter or select the desired value.

RTSP ports

If necessary, select a different port for the exchange of the RTSP data. The standard RTSP port is 554. Select **Off** to deactivate the RTSP function.

Zero configuration address

Enable or disable the zero configuration discovery of the selected camera.

Zero configuration is an alternative method to DHCP and DNS for assigning IP addresses to cameras. It automatically creates a usable IP network address without configuration or special servers.

Note: In the ONVIF standard only the service discovery of zero configuration is used.

Alternatively without zero configuration the network must provide services, such as DHCP or DNS.

Otherwise configure the network settings of each IP camera manually.

ONVIF discovery mode

If enabled, the camera can be scanned in the network. This includes its capabilities.

If disabled, the camera does not send any discovery messages to avoid denial-of-service attacks.

We recommend disabling the discovery after adding the camera to the configuration.

Enter or select the desired value.

Enable DynDNS

Allows for enabling DynDNS.

A dynamic Domain Name Service (DNS) allows you to select the unit via the Internet using a host name, without having to know the current IP address of the unit. To do this, you must have an account with one of the dynamic DNS providers and you must register the required host name for the unit on that site.

Note:

For information about the service, registration process and available host names refer to the DynDNS provider on dyndns.org.

Type

Enter or select the desired value.

Name



Type in the name of your DynDNS user account.

TTL



Enter or select the desired value.

15.4.13

Scopes

Main window > **Devices** > Expand  > Expand  > Expand  > Expand  > **ONVIF Configuration** tab > **Network** tab > **Scopes** tab

or

Main window > **Devices** > Expand  >  > **ONVIF Configuration** tab > **Network** tab > **Scopes** tab

You can add or remove scopes to your ONVIF device with URIs having the following format:

`onvif://www.onvif.org/<path>`

The following example illustrates the usage of the scope value. This is just an example, and not at all an indication of what type of scope parameter to be part of an encoder configuration. In this example we assume that the encoder is configured with the following scopes:

- `onvif://www.onvif.org/location/country/china`
- `onvif://www.onvif.org/location/city/beijing`
- `onvif://www.onvif.org/location/building/headquarter`
- `onvif://www.onvif.org/location/floor/R5`
- `onvif://www.onvif.org/name/ARV-453`

You can give the device a detailed location and device name to identify it within your list of devices.

The table shows the basic capabilities and other properties of the device, which are standardized:

Category	Defined values	Description
type	video_encoder	The device is a network video encoder device.
	Ptz	The device is a PTZ device.
	audio_encoder	The device provides audio encoder support.
	video_analytics	The device supports video analytics.
	Network_Video_Transmitter	The device is a network video transmitter.
	Network_Video_Decoder	The device is a network video decoder.
	Network_Video_Storage	The device is a network video storage device.
	Network_Video_Analytic	The device is a network video analytics device.
location	Any character string or path value.	Not supported by BVMS.

Category	Defined values	Description
hardware	Any character string or path value.	A string or path value describing the hardware of the device. A device shall include at least one hardware entry into its scope list.
name	Any character string or path value.	The searchable name of the device. This name is displayed in the Device and the Logical Tree.

The scope name, model, manufacturer determine how the device appears in the Device Tree and the ONVIF Encoder Identification and Main Settings.

15.4.14

Relays

Main window > **Devices** > Expand  > Expand  > Expand  > Expand  >  > **ONVIF Configuration** tab > **Interfaces** tab > **Relay** tab

Main window > **Devices** > Expand  >  > **ONVIF Configuration** tab > **Interfaces** tab > **Relay** tab

The physical idle state of a relay output can be configured by setting the idle state to **open** or **closed** (inversion of the relay behavior).

The available digital outputs of the device are listed with their name, e.g.:

- **AlarmOut_0**
- **AlarmOut_1**

For any event mapping of relays within BVMS use the names listed here.

Mode

The relay can work in two relay modes:

- **Bistable:** After setting the state, the relay remains in this state.
- **Monostable:** After setting the state, the relay returns to its idle state after the specified delay time.

Idle state

Select **Open** if you want the relay to operate as a normally open contact, or select **Closed** if the relay is to operate as a normally closed contact.

Delay time

Set the delay time. After this time period, the relay switches back to its idle state if configured in the **Monostable** mode.

If you like to test any configurations related to a relay status change, click **Activate** or **Deactivate** to switch the relay. You can check the configured camera relay events for correct functioning: Status display of the relay icon in Logical Tree, Events in Alarm List or Event Log.

Activate

Click to switch the relay to the configured idle state.

Deactivate

Click to switch the relay to the configured non-idle state.

15.5



ONVIF Event Source page

Main window > **Devices** > Expand  > Expand  > Expand  > Expand  > Expand  >  > **ONVIF Event Source** tab

or

Main window > **Devices** > Expand  > Expand  >  > **ONVIF Event Source** tab

or

Main window > **Devices** > Expand  > Expand  > Expand  > Expand  > Expand  >  > **ONVIF Event Source** tab

or

Main window > **Devices** > Expand  > Expand  >  > **ONVIF Event Source** tab

or

Main window > **Devices** > Expand  > Expand  > Expand  > Expand  > Expand  >  > **ONVIF Event Source** tab

or

Main window > **Devices** > Expand  > Expand  >  > **ONVIF Event Source** tab

You can configure ONVIF events of a source (video channel, input or relay). An activated event definition is added to the Mapping Table of the encoder.

For example for a multichannel encoder, you configure for which camera a **Motion Detected** event is triggered.

Trigger Event

Activate this event.

ONVIF Topic

Type in or select a string.

ONVIF Source Name

Type in or select a string.

ONVIF Source Type

Type in or select a string.

ONVIF Source Value

Type in or select a string.

Refer to

- *ONVIF event mapping, page 42*
- *Configuring an ONVIF mapping table, page 230*

15.6

Assigning an ONVIF profile

Main window > **Cameras and recording** > 

You can assign an ONVIF Media Profile token to an ONVIF camera. You can assign either for live video or for recording.

To assign a live video token:

- ▶ In the **Live Video - Profile** column, select the desired entry.

To assign a recording token:

- ▶ In the **Recording - Profile** column, select the desired entry.

Refer to

- *Cameras page, page 271*

16 Maps and Structure page



Notice!

BVMS Viewer offers only basic features. Advanced features are included in BVMS Professional. For detailed information about the different BVMS editions refer to www.boschsecurity.com and the BVMS Quick Selection Guide: [BVMS Quick Selection Guide](#).

The count of items below an entry is displayed in square brackets.

Main window > **Maps and structure**

Permissions can get lost. If you move a group of devices, these devices lose their permission settings. You must set the permissions on the **User groups** page again.

Displays the Device Tree, the Logical Tree, and the **Global map** window.

Allows you to introduce a structure for all the devices in your BVMS. Your structure is displayed in the Logical Tree.

Allows you to perform the following tasks:

- Configuring the full Logical Tree
- Managing resources
- Creating Command Scripts
- Creating sequences
- Creating map viewports
- Creating malfunction relays
- Adding site maps and creating hotspots

Hotspots on maps can be:







- Cameras
- Inputs
- Relays
- Command Scripts
- Sequences
- Documents
- Links to other site maps
- VRM
- iSCSI
- Readers of an access control system
- Intrusion panels
- Management Server of Enterprise Systems

Resource files can be:

- Map files
- Document files
- Links to external URLs
- Audio files
- Links to external applications

Icons

	Displays a dialog box for managing resource files.
	Displays a dialog box for adding or managing Command Scripts to the Logical Tree.
	Displays a dialog box for adding or editing a camera sequence file.

	Creates a folder in the logical tree.
	Displays a dialog box for adding map resource files.
	Creates a map viewport in the logical tree.
	Displays a dialog box for adding a document file.
	Displays a dialog box for adding a link to an external application.
	Displays a dialog box for adding a malfunction relay.

Symbols

	Device was added to the Logical Tree.
---	---------------------------------------

To search for items:

- ▶ In the search field type a string and press the ENTER key to filter the displayed items.
Only items containing the string and their corresponding parent items (only in trees) are displayed. The count of filtered items and the total count of items is provided.

Note: Enclose strings with double quotes to find them exactly, for example "Camera 1" exactly filters the cameras with this name, not camera 201.



17 Configuring maps and the logical tree

This chapter provides information on how to configure the Logical Tree and how to manage resource files such as maps.



Notice!

If you move a group of devices in the Logical Tree, these devices lose their permission settings. You must set the permissions in the **User groups** page again.

- Click  to save the settings.
- Click  to undo the last setting.
- Click  to activate the configuration.

Refer to

- *Resource Manager dialog box, page 251*
- *Select Resource dialog box, page 251*
- *Sequence Builder dialog box, page 254*
- *Add Sequence dialog box, page 256*
- *Add Sequence Step dialog box, page 256*
- *Add URL dialog box, page 252*
- *Select Map for Link dialog box, page 257*
- *Malfunction Relay dialog box, page 264*
- *Link to External Application dialog box, page 253*

17.1 Configuring the Logical Tree

Main window > **Maps and structure** > **Logical tree** tab

You can add devices, resource files, map viewports, sequences, client command scripts, and folders to the logical tree. Devices are listed in the device tree and you can drag any level of the device tree to the logical tree.

A resource file can be, for example, a site map, a document, a web file, an audio file, or a command script.

- A site map is a file that you can add to the logical tree. Adding a site map to the logical tree creates a map folder in which you can organize the logical devices that are specific to the map.
- A map viewport is an area of a global map with a specific center and zoom level.
- A folder allows you to further organize devices in the logical tree.

When you start the Configuration Client for the first time, the logical tree is empty.

If a user group does not have the permission to access a device (e.g., a camera), the device is not being displayed on the site map, on the map viewport, or in the logical tree.

You can add the following items from the device tree or the logical tree as hot spots to a site map:

- Cameras
- Inputs
- Relays
- Command Scripts
- Sequences

- Documents
- Links to other site maps
- VRM
- iSCSI
- Readers of an access control system
- Intrusion panels
- Management Server of Enterprise Systems

Adding an item to a site map creates a hot spot on the map.

When you add an item to a map folder in the logical tree, it is also displayed on the upper left corner of the map. When you add an item to a map, it is also added under the corresponding map node in the logical tree of the Operator Client.

You can add the following items from the device tree to the global map:

- Cameras

To configure the logical tree you perform some of or all the following steps several times.

To rename the logical tree:

1. Select the logical tree root item.

2. Click  .

3. Enter the new name.

This name is visible for all users in the logical tree of the Operator Client.

Refer to

- *Maps and Structure page, page 246*

17.2

Adding a device to the Logical Tree

Main window > **Maps and structure** > **Logical tree** tab

To add a device:

- ▶ Drag an item from the Device Tree to the required location in the Logical Tree.
You can drag a complete node with all sub-items from the Device Tree to the Logical Tree.
You can select multiple devices by pressing the CTRL- or the SHIFT-key.

Refer to

- *Maps and Structure page, page 246*

17.3

Removing a tree item

Main window > **Maps and structure** > **Logical tree** tab

To remove a tree item from the Logical Tree:

- ▶ Right-click an item in the Logical Tree and click **Remove**. If the selected item has sub-items, a message box is displayed. Click **OK** to confirm. The item is removed.
When you remove an item from a map folder of the Logical Tree, it is also removed from the map.

Refer to

- *Maps and Structure page, page 246*

17.4

Managing resource files

Main window > **Maps and structure** > > **Logical tree** tab > 
or

Main window > **Alarms** > 

You can import resource files in the following formats:

- DWF files (2 D, map resource files)
- PDF
- JPG
- PNG
- HTML files
- MP3 (audio file)
- TXT files (Command Scripts or camera sequences)
- MHT files (Web archives)
- URL files (links to Web pages)
- HTTPS URL files (links to Intelligent Insights widgets)
- WAV (audio file)

The imported resource files are added to a database. They are not linked to the original files.



Notice!

After each of the following tasks:

Click  to save the settings.

To import a resource file:

1. Click  .
The **Import Resource** dialog box is displayed.
2. Select one or more files.
3. Click **Open**.
The selected files are added to the list.
If a file has already been imported, a message box is displayed.
If you decide to import an already imported file again, a new entry is added to the list.

To remove a resource file:

1. Select a resource file.
2. Click  .
The selected resource file is removed from the list.

To rename a resource file:

1. Select a resource file.
2. Click  .
3. Enter the new name.
The original file name and creation date persists.

To replace the content of a resource file:

1. Select a resource file.
2. Click  .
The **Replace Resource** dialog box is displayed.
3. Select a file with the appropriate content and click **Open**.
The resource name persists, the original file name is exchanged with the new file name.

To export a resource file:

1. Select a resource file.
2. Click  .
A dialog box for selecting a directory is displayed.
3. Select the appropriate directory and click **OK**.
The original file is exported.

Refer to

- *Select Resource dialog box, page 251*

17.4.1

Resource Manager dialog box

Main window > **Maps and structure** >  > **Resource Manager** dialog box
Allows you to manage resource files.

You can manage the following file formats:

- DWF files (map resource files)
For use in Operator Client, these files are converted to a bitmap format.
- PDF
- JPG
- PNG
- HTML files (HTML documents, e.g. action plans)
- MP3 (audio file)
- TXT files (text files)
- URL files (contain links to web pages or Intelligent Insights widgets)
- MHT files (Web archives)
- WAV (audio file)
- EXE



Click to display a dialog box for importing a resource file.



Click to display the **Add URL** dialog box.



Click to display the **Link to External Application** dialog box.



Click to remove the selected resource file.



Click to rename the selected resource file.



Click to display a dialog box for replacing the selected resource file with another one.



Click to display a dialog box for exporting the selected resource file.

17.4.2

Select Resource dialog box

Main window > **Maps and structure** > 
Allows you to add a map file in DWF, PDF, JPG or PNG format to the Logical Tree.

Select a resource file:

Click a filename to select a map file. The content of the selected file is displayed in the preview pane.

Manage...

Click to display the **Resource Manager** dialog box.

Refer to

- *Adding a map, page 256*
- *Assigning a map to a folder, page 257*
- *Adding a document, page 252*

17.5 Adding a document

Main window > **Maps and structure** > **Logical tree** tab

You can add text files, HTML files (including MHT files), URL files (containing an Internet address) or HTTPS URL files (for example containing an Intelligent Insights widget) as documents. And you can add a link to another application.

Before you can add a document, you must have document files imported.

To import document files see *Managing resource files, page 249* for details.

To add a map document file / to add an Intelligent Insights widget:

1. Ensure that the document file that you want to add has already been imported.
2. Select a folder where you want to add the new document.

3. Click . The **Select Resource** dialog box is displayed.
4. Select a file in the list. If the required files are not available in the list, click **Manage...** to display the **Resource Manager** dialog box for importing files.
5. Click **OK**. A new document is added under the selected folder.

Refer to

- *Select Resource dialog box, page 251*
- *Managing resource files, page 249*

17.5.1 Add URL dialog box

Main window > **Maps and structure** >  > 

Allows you to add an HTTP Internet address (URL) or an HTTPS Internet Address such as Intelligent Insights widgets to your system. You can add this URL to the Logical Tree as a document. The user can display an Internet page or an Intelligent Insights widget in his Operator Client.

Name

Type a display name for the URL.

URL

Type the URL.

For secure connection only**User**

Type the user name for the HTTPS URL.

Password:

Type the password for the HTTPS URL.



Show password

Click to enable that the entered password is displayed. Be careful that nobody can spy out this password.

Refer to

– *Adding a document, page 252*

17.6**Link to External Application dialog box**

Main window > **Maps and structure** > **Logical tree** tab >  > **Resource Manager** dialog box >  > **Link to External Application** dialog box

Allows you to add a link to an external application. The link must be valid on the workstation where this link is used.

**Notice!**

An external application that starts with a splash screen will not work as expected.
An external application which shares functions with Operator Client, will not work as expected and can, under rare circumstances, lead to a crash of Operator Client.

Name

Type in a name for the link that is displayed in the Logical Tree.

Path

Type in or browse the path to the external application. This path must be valid on the workstation where the user of Operator Client uses this link.

Arguments

If required, type in arguments for the command that executes the external application.

17.7**Adding a Command Script**

Main window > **Maps and structure** > **Logical tree** tab

Before you can add a Command Script, you must have Command Script files imported or created.

If required, see *Configuring Command Scripts, page 90* for details.

To add a Command Script file:

1. Select a folder where you want to add the new Command Script.

2. Click . The **Select Client Script** dialog box is displayed.

3. Select a file in the list.

4. Click **OK**.

A new Command Script is added under the selected folder.

Refer to

– *Select Resource dialog box, page 251*

17.8**Adding a camera sequence**

Main window > **Maps and structure** > **Logical tree** tab

You add a camera sequence to the root directory or to a folder of the Logical Tree.

To add a camera sequence:

1. In the Logical Tree, select a folder where you want to add the new camera sequence.

2. Click . The **Sequence Builder** dialog box is displayed.

3. In the list, select a camera sequence.

- Click **Add to Logical Tree**. A new  is added under the selected folder.

Refer to

- *Sequence Builder dialog box, page 254*



17.8.1

Sequence Builder dialog box

Main window > **Maps and structure** > 

Allows you to manage camera sequences.

Icons

	Click to display the Add Sequence dialog box.
	Click to rename a camera sequence.
	Click to remove the selected camera sequence.

Add Step

Click to display the **Add Sequence Step** dialog box.

Remove Step

Click to remove selected steps.

Step

Displays the number of the step. All cameras of a particular step have the same dwell time.

Dwell

Allows you to change the dwell time (seconds).

Camera Number

Click a cell to select a camera via its logical number.

Camera

Click a cell to select a camera via its name.

Camera Function

Click a cell to change the function of the camera in this row.

Data

Type the time for the duration of the selected camera function. To configure this, you must have selected an entry in the **Camera** column and an entry in the **Camera Function** column.

Data Unit

Select the unit for the selected time, for example seconds. To configure this, you must have selected an entry in the **Camera** column and an entry in the **Camera Function** column.

Add to Logical Tree

Click to add the selected camera sequence to the Logical Tree and to close the dialog box.

Refer to

- *Managing pre-configured camera sequences, page 254*

17.9

Managing pre-configured camera sequences

Main window > **Maps and structure** > **Logical tree** tab

You can perform the following tasks for managing camera sequences:

- Create a camera sequence
- Add a step with a new dwell time to an existing camera sequence
- Remove a step from camera sequence
- Delete a camera sequence



Notice!

When the configuration is changed and activated, a camera sequence (pre-configured or automatic) usually is continued after restart of the Operator Client.

But in the following cases the sequence is not continued:

A monitor where the sequence is configured to be displayed has been removed.

The mode of a monitor (single/quad view) where the sequence is configured to be displayed has been changed.

The logical number of a monitor where the sequence is configured to be displayed is changed.



Notice!

After each of the following tasks:

Click to save the settings.

To create a camera sequence:

1. In the Logical Tree, select a folder where you want to create the camera sequence.

2. Click .

The **Sequence Builder** dialog box is displayed.

3. In the **Sequence Builder** dialog box, click .

The **Add Sequence** dialog box is displayed.

4. Enter the appropriate values.
5. Click **OK**.

A new camera sequence is added.

For detailed information on the various fields, see the Online Help for the appropriate application window.

To add a step with a new dwell time to a camera sequence:

1. Select the desired camera sequence.
2. Click **Add Step**.
The **Add Sequence Step** dialog box is displayed.
3. Make the appropriate settings.
4. Click **OK**.

A new step is added to the camera sequence.

To remove a step from a camera sequence:

- ▶ Right-click the desired camera sequence and click **Remove Step**.
The step with the highest number is removed.

To delete a camera sequence:

1. Select the desired camera sequence.
2. Click . The selected camera sequence is removed.

Refer to

– *Sequence Builder dialog box, page 254*

17.9.1 Add Sequence dialog box

Main window > **Maps and structure** >  > **Sequence Builder** dialog box > 
Allows you to configure the properties of a camera sequence.

Sequence name:

Type an appropriate name for the new camera sequence.

Logical number:

For using with a Bosch IntuiKey keyboard, enter a logical number for the sequence.

Dwell time:

Enter the appropriate dwell time.

Cameras per step:

Enter the number of cameras in each step.

Steps:

Enter the appropriate number of steps.

17.9.2 Add Sequence Step dialog box

Main window > **Maps and structure** >  > **Add Step** button
Allows you to add a step with a new dwell time to an existing camera sequence.



Dwell time:

Enter the appropriate dwell time.

17.10 Adding a folder

Main window > **Maps and structure** > **Logical tree** tab

To add a folder:

1. Select a folder where you want to add the new folder.
2. Click . A new folder is added under the selected folder.
3. Click  to rename the folder.
4. Type the new name and press ENTER.

Refer to

– *Maps and Structure page, page 246*

17.11 Adding a map

Main window > **Maps and structure** > **Logical tree** tab

Before you can add a map, you must have map resource files imported.

To import a map resource file see *Managing resource files, page 249* for details.

To add a map:

1. Ensure that the map resource file that you want to add has already been imported.
2. Select a folder where you want to add the new map.
3. Click . The **Select Resource** dialog box is displayed.

4. Select a file in the list.
If the required files are not available in the list, click **Manage...** to display the **Resource Manager** dialog box for importing files.
5. Click **OK**.

A new map  is added under the selected folder.
The map is displayed.
All devices within this folder are displayed in the upper left corner of the map.

Refer to



– *Select Resource dialog box, page 251*

17.12 Adding a link to another map

Main window > **Maps and structure** > **Logical tree** tab

After you have added at least two maps, you can add a link on one map to the other so that the user can click from one map to a linked one.

To add a link:

1. Click a map folder  in the Logical Tree.
2. Right-click the map and click **Create Link**.
The **Select map for link** dialog box is displayed.
3. In the dialog box, click a map .
4. Click **Select**.
5. Drag the item to the appropriate place on the map.

17.12.1 Select Map for Link dialog box

Main window > **Maps and structure** > Select a map folder  in the Logical Tree > On the map, right-click and click **Create Link**
Allows you to select a map for creating a link to another map.

 Click another map to select.

Select

Click to insert the link to the selected map.

17.13 Assigning a map to a folder

Main window > **Maps and structure** > **Logical tree** tab

Before you can assign maps, you must have map resource files imported.

If required, see *Managing resource files, page 249* for details.

To assign a map resource file:

1. Right-click a folder and click **Assign Map**.
The **Select Resource** dialog box is displayed.
2. Select a map resource file in the list.
3. Click **OK**. The selected folder is displayed as .
The map is displayed in the map window.
All items within this folder are displayed in the upper left corner of the map.

Refer to

- *Maps and Structure page, page 246*
- *Select Resource dialog box, page 251*

17.14**Managing devices on a site map**

Main window > **Maps and structure** > **Logical tree** tab

Before you can manage devices on a site map you must add a map or assign a map to a folder and add devices to this folder.

**Notice!**

After each of the following tasks:

Click  to save the settings.

To place items on a site map:

1. Select a map folder.
2. Drag devices from the device tree to the map folder.
The devices of a map folder are located on the left upper corner of the site map.
3. Drag the items to the appropriate places on the site map.

To remove an item in the logical tree only from the site map:

1. Right-click the item on the map and click **Invisible**.
The item is removed from the site map.
The item remains in the logical tree.
2. To make it visible again, right-click the device in the logical tree and click **Visible In Map**.

To remove an item from the site map and from the full logical tree:

- ▶ Right-click the item in the logical tree and click **Remove**.
The item is removed from the site map and from the logical tree.

To change the icon for the orientation of a camera:

- ▶ Right-click the item, point to **Change Image**, and then click the appropriate icon.
The icon changes accordingly.

To change the color of an item:

- ▶ Right-click the item and click to **Change Color**. Select the appropriate color.
The icon changes accordingly.

To bypass / unbypass a device on a site map:

1. Right-click the certain device on the site map.
2. Click **Bypass / Unbypass**.

**Notice!**

It is possible to filter bypassed devices in the search text field.

Refer to

- *Configuring bypass of devices, page 264*
- *Maps and Structure page, page 246*

17.15**Configuring the global map and map viewports**

Main window > **Maps and structure** > **Global map** tab

In order to use online maps or the Map-based tracking assistant in the Operator Client you have to add and configure cameras on the global map. You can configure map viewports from a global map. A map viewport is an area of the global map with a specific center and zoom level. A map viewport can be displayed in an image pane of the Operator Client.

If you want to create a map viewport or use the Map-based tracking assistant in the Operator Client, do the following first:

1. Select the background map type of the global map.
2. Drag your cameras to the global map.
3. Configure the direction and view cone of your cameras on the global map.

If you want to create map viewports or use the Map-based tracking assistant in the Operator Client **on multiple floors**, do the following first:

1. Select the background map type of the global map.
2. Add a map to the global map.
 - Note:**The first map that you add will be the ground floor. If you select the offline background map type **None**, the first map that you add will be the background map.
3. Add floors to the ground floor or to the background map.
4. Select the required floor.
5. Drag your cameras to the floor map.
6. Configure the direction and view cone of your cameras.

17.15.1

Configuring the global map

You can define background map types for the global map and search for cameras, locations and addresses.

To change the background map type of the global map:

1. Go to the Main window and select the **Settings** menu > **Options...** command.
2. Select the appropriate option.
 - Note:** If you have access to the internet you can select an online background map type (Here maps). If you do not have access to the internet select the offline background map type **None**.
 - You have to purchase a license to use online maps.**
3. If you selected an online background map type, enter your customer specific API key.
4. Click **Test** to check the API connection.
5. Click **OK**.



Notice!

If you switch the type of background map from online (Here maps) to offline (**None**) or the other way around you lose all positioned camera hotspots and map viewports. You can define only one background for the global map. This background applies to all map viewports.

To search for cameras or locations on the global map:

1. Type the name of a camera, location or address in the search field.
 - As soon as you start typing a dropdown menu with a list of relevant options displays.
2. Select the respective option from the list

The camera, location or address displays and is indicated with a flag  for some seconds.

Refer to

- *Options dialog box (Settings menu), page 119*

17.15.2**Configuring cameras on the global map****To configure a camera on the global map:**

Note: If you have configured multiple floors on maps, make sure you select the correct floor where you want to configure your cameras.

1. Select the **Global map** tab.
2. To go to the position, where you want to place your camera, type an address or a location in the search field.

You can also zoom in and out by using the  and  buttons or the mouse scroll wheel.

3. Drag a camera from the device tree to the respective area of the global map.
4. Click on the camera to select it.
5. Configure the direction and the view cone of the camera.

Note: When you select a dome camera, you see the reachable view cone and the actual view cone. A warning symbol indicates that the actual view cone of the dome camera needs a horizontal and vertical calibration. To calibrate the dome camera, open the live video preview.

6. Click  to see a live video preview of the selected camera.
The video preview may help you to configure the direction and view cone.

7. Click  to hide the video preview of the selected camera.

Note: If you add a camera to the global map and you did not already add this camera to the logical tree, it will be automatically added at the end of the logical tree.

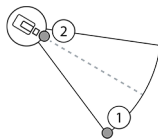
To configure the direction and the view cone of a camera:

1. Drag to configure the view cone.
2. Drag to rotate and configure the direction.

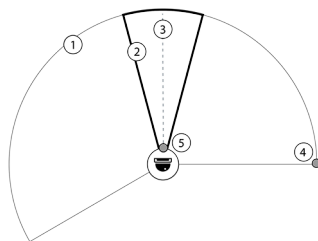

To configure the horizontal direction and view cone of a PTZ camera (platform CPP4 or higher):

1. The reachable view cone indicates the theoretically reachable view area.
2. The actual view cone indicates the actual PTZ position of the PTZ camera
3. Pan angle 0.
4. Drag to configure the view cone.
5. Drag to rotate and configure the direction.

**Notice!**

To ensure the optimal usage of the Map-based tracking assistant, you also have to adjust the vertical position of the PTZ camera. We recommend to adjust the vertical position in the live video preview based on a well-known position in the area, for example based on a distinctive monument. The Map-based tracking assistant will later always use this configured vertical position.

To display or hide camera previews:

1. Click  to see a live video preview of the selected camera.
Or
Right-click the camera and select **Show previews**.
The video preview may help you to configure the direction and view cone.
2. Click  to hide the video preview of the selected camera.
Or
Right-click the camera and select **Hide previews**.

To remove a camera from the global map:

- ▶ Right-click the camera and select **Remove**.

To make a camera visible on all floors:

- ▶ Right-click the camera hotspot and select **Visible on all floors**.
The camera is now always visible when you select another floor.

Clustering of camera hotspots

If you already have several cameras configured on the global map and zoom out, the camera hotspots are clustered to hot spot groups. The number of individual hotspots in a hotspot group displays. A selected camera does not display as part of a cluster.

17.15.3

Adding maps on the global map

You can add your own building map files on top of the global map. The BVMS operators can then have a more detailed view of certain camera locations.

To add a map on the global map:

1. Select the **Global map** tab.
2. To go to the position, where you want to place your map, type an address or a location in the search field.

You can also zoom in and out by using the  and  buttons or the mouse scroll wheel.

3. Click .
The **Select Resource** window opens.
4. Select a map and click **OK**.
5. Click and drag ↻ to rotate the map.
6. Click and drag + to move the map.
7. Use the drag points to adjust the size of your map.
8. Click × to remove the map.

Note: If you want to add multiple floors, the first map that you add will be the ground floor.

The ground floor is indicated by the number 0 in the  field.

To add more floors to the ground floor:

1. Click the number 0 in the  field.

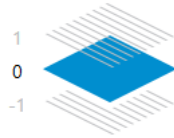

The  field opens.



2. Select the floor where you want to add a map.
3. **Note:** You can only select the next higher or lower floor to add a map.

4. Click .

The **Select Resource** window opens.

5. Select a map and click **OK**.
6. Modify the added floor map to fit the position to the position of the ground floor map.

To make a floor visible on all floors:

1. Right-click on any of the adjustment icons of the respective floor map, , , or .
2. Select **Visible on all floors**.

This floor is now always visible when you select another floor.

Note: If you do not have access to the internet and you selected the offline background map type **None**, you can add a map as background map. We recommend to make this background map visible on all floors. The background map will then always be visible if you select another floor.

17.16 Adding a map viewport

Main window > **Maps and structure** > **Logical tree** tab

To add a map viewport:

1. Click  to add a map viewport.
2. Type the name of your map viewport.
3. To go to the location where you want to create your map viewport, type an address or location in the search field of the global map.

If you do not know the address or location, you can zoom in and out by using the 

and  buttons or the mouse scroll wheel.

4. Click  to save your configuration.

**Notice!**

If a map viewport contains different floors, the floor that is selected when saving the configuration, is the one displayed in the Operator Client when the operator opens the map viewport. The operator can change the floor of the map viewport in the image pane afterwards.

17.17 Enabling the Map-based tracking assistant

The Map-based tracking assistant helps you to track moving objects across multiple cameras. The respective cameras have to be configured on the global map. If an interesting moving object appears in live, playback, or in an alarm image pane, the user can start the Map-based tracking assistant that displays all nearby cameras automatically.

To enable the Map-based tracking assistant:

1. Go to the Main window and select the **Settings** menu > **Options...** command.
2. Select the **Enable system feature** check box.
3. Click **OK**.

17.18 Adding a malfunction relay

Main window > **Maps and structure** > **Logical tree** tab >  > **Malfunction Relay** dialog box

Intended use

A malfunction relay is intended to switch in case of any severe system error to trigger an external alert (strobe, siren, etc.).

The user must reset the relay manually.

The malfunction relay can be one from the following list:

- BVIP encoder or decoder relay
- ADAM relay
- Intrusion panel output

Example

If something happens that severely affects the system functioning (for example a hard disk failure) or an incident occurs that endangers the security of a site (for example a failing reference image check), the malfunction relay is activated. This can for example trigger an audible alarm or can close doors automatically.

Functional description

You can configure a single relay to act as a malfunction relay. The malfunction relay gets activated automatically when an event from a set of user-defined events is triggered. Activation of a relay means that a command will be sent to the relay to close it. The subsequent “Relay Closed” event is decoupled from the command and will only be generated and received if the relay state is physically changed! For example a relay being closed before, will not send this event.

Apart from being automatically triggered by the set of user-defined events, the malfunction relay is treated like any other relay. Therefore, the user is able to deactivate the malfunction relay in Operator Client. The Web Client also allows deactivating the malfunction relay. Because the regular access permissions apply to the malfunction relay as well, all clients need to consider the permissions of the logged-on user.

To add:

1. In the **Malfunction Relay** list, select the desired relay.
2. Click **Events...**
The **Events selection for Malfunction Relay** dialog box is displayed.
3. Click to select the desired events that can trigger the malfunction relay.
4. Click **OK**.

The malfunction relay is added to the system.

17.18.1 Malfunction Relay dialog box

Main window > **Maps and structure** > **Logical tree** tab >  > **Malfunction Relay** dialog box
You can add a malfunction relay to your system. You define the relay that is to be used as malfunction relay and you configure the events that can trigger the malfunction relay.
The relay must already be configured in the Logical Tree.

Malfunction Relay

In the list, select the desired relay.

Events...

Click to display the **Events selection for Malfunction Relay** dialog box.

17.19 Configuring bypass of devices

Main window > **Maps and structure** > **Logical tree** tab

It is possible to bypass certain encoders, cameras, inputs and relays, for example, during construction work. If an encoder, camera, input or relay is bypassed, recording is stopped, the BVMS Operator Client does not display any events or alarms and alarms are not recorded in the Logbook.

The bypassed cameras still show live video in the Operator Client and the Operator still has access to old recordings.



Notice!

If the encoder is bypassed, no alarms and events are generated for all cameras, relays and inputs of this encoder. If a certain camera, relay or input is bypassed separately and the certain device will be disconnected from the encoder, these alarms are still generated.

To bypass / unbyypass a device in the Logical Tree or in the Device Tree:

1. In the Logical Tree or in the Device Tree right-click the certain device.
2. Click **Bypass / Unbypass**.

To bypass / unbyypass a device on a map:

See *Managing devices on a site map, page 258*



Notice!

It is possible to filter bypassed devices in the search text field.

Refer to

- *Managing devices on a site map, page 258*

18 Schedules page

Main window >

Allows you to configure Recording Schedules and Task Schedules.



Click to rename the selected Recording or Task Schedule.

Recording Schedules

Displays the Recording Schedules Tree. Select an entry for configuring.

Task Schedules

Displays the Task Schedules Tree. Select an entry for configuring.

Add

Click to add a new Task Schedule.

Delete

Click to delete the selected Task Schedule.

Refer to

– *Configuring schedules, page 267*

18.1 Recording Schedules page

Main window > > Select an item in the Recording Schedules tree

Allows you to configure Recording Schedules.

Weekdays

Click to display the Schedule Table for weekdays. The time periods of all configured Recording Schedules are displayed.

Drag the pointer to select the time periods for the selected schedule. All selected cells get the color of the selected schedule.

The 24 hours of the day are displayed horizontally. Every hour is divided into 4 cells. One cell represents 15 minutes.

Holidays

Click to display the Schedule Table for holidays.

Exception Days

Click to display the Schedule Table for exception days.

Add

Click to display a dialog box for adding the required holidays or exception days.

Delete

Click to display a dialog box for removing holidays or exception days.

Refer to

- *Configuring a Recording Schedule, page 267*
- *Adding holidays and exception days, page 269*
- *Removing holidays and exception days, page 270*
- *Renaming a schedule, page 270*

18.2 Task Schedules page

Main window > > Select an item in the Task Schedules tree

Allows you to configure the available Task Schedules. You can configure a standard or a recurring pattern.

Standard

Click to display the Schedule Table for configuring standard Task Schedules. If you configure a Standard Pattern, no Recurring Pattern is valid for the selected schedule.

Recurring

Click to display the Schedule Table for configuring a recurring pattern for the selected Task Schedule. For example, you configure a schedule for every second Tuesday of every month or for the 4th of July of every year. If you configure a recurring pattern, no standard pattern is valid for the selected Task Schedule.

Weekdays

Click to display the Schedule Table for weekdays.

Drag the pointer to select the time periods for the selected schedule. The selected cells are displayed in the color of the selected schedule.

The 24 hours of the day are displayed horizontally. Every hour is divided into 4 cells. One cell represents 15 minutes.

Holidays

Click to display the Schedule Table for holidays.

Exception Days

Click to display the Schedule Table for exception days.

Clear All

Click to clear the time periods of all available days (weekdays, holidays, exception days).

Select All

Click to select the time periods of all available days (weekdays, holidays, exception days).

Add...

Click to display a dialog box for adding the required holidays or exception days.

Delete...

Click to display a dialog box for deleting holidays or exception days.

Recurrence Pattern

Click the frequency with which you want the Task Schedule to recur (Daily, Weekly, Monthly, Yearly) and then select the corresponding options.

Day Pattern

Drag the pointer to select the time period(s) for the recurring pattern.

Refer to

- *Adding a Task Schedule, page 268*
- *Configuring a standard Task Schedule, page 268*
- *Configuring a recurring Task Schedule, page 268*
- *Removing a Task Schedule, page 269*
- *Adding holidays and exception days, page 269*
- *Removing holidays and exception days, page 270*
- *Renaming a schedule, page 270*

19 Configuring schedules

Main window > **Schedules**

There are two schedule types available:

- Recording Schedules
- Task Schedules



You can configure a maximum of 10 different Recording Schedules in the Recording Schedule Table. In these segments the cameras can behave differently. For example, they can have different frame rate and resolution settings (to be configured in the **Cameras and recording** page). In every point in time, exactly one Recording Schedule is valid. There are no gaps and no overlaps.

You configure Task Schedules for scheduling various events which can occur in your system (to be configured in the **Events** page).

See glossary for definitions of Recording Schedules and Task Schedules.

The schedules are used in other pages of the Configuration Client:

- **Cameras and recording** page
Used to configure recording.
- **Events** page
Used to determine when events cause logging, alarms, or execution of Command Scripts.
- **User groups** page
Used to determine when the members of a user group can log on.

- Click  to save the settings.
- Click  to undo the last setting.
- Click  to activate the configuration.

Refer to

- *Recording Schedules page, page 265*
- *Task Schedules page, page 265*

19.1 Configuring a Recording Schedule

Main window > **Schedules**

You can add exception days and holidays to any Recording Schedule. These settings override the normal weekly settings.

The sequence of decreasing priority is: exception days, holidays, weekdays.

The maximum number of Recording Schedules is 10. The first three entries are configured by

default. You can change these settings. Entries with the gray icon  do not have a time period configured.

Recording Schedules share the same weekdays.

Each Standard Task Schedule has its own weekdays patterns.

To configure a Recording Schedule:

1. In the **Recording Schedules** tree, select a schedule.
2. Click the **Weekdays** tab.
3. In the **Schedule Table** field, drag the pointer to select the time periods for the selected schedule. The selected cells are displayed in the color of the selected schedule.

Notes:

- You can mark a time period on a weekday of a Recording Schedule with the color of another Recording Schedule.

Refer to

- *Recording Schedules page, page 265*

19.2 Adding a Task Schedule

Main window > **Schedules**

To add a Task Schedule:

1. Click **Add**.
A new entry is added.
2. Enter the appropriate name.
3. Click **Standard** for a standard Task Schedule or **Recurring** for a recurring Task Schedule. If you change the setting, a message box is displayed. Click **OK** if you want to change the schedule type.

A standard Task Schedule is displayed as , a recurring Task Schedule as .

4. Make the appropriate settings for the selected schedule.

Refer to

- *Task Schedules page, page 265*

19.3 Configuring a standard Task Schedule

Main window > **Schedules**

Each standard Task Schedule has its own weekdays patterns.

To configure a standard Task Schedule:

1. In the **Task Schedules** tree, select a standard Task Schedule.
2. Click the **Weekdays** tab.
3. In the **Schedule Table** field, drag the pointer to select the time periods for the selected schedule.

Refer to

- *Task Schedules page, page 265*

19.4 Configuring a recurring Task Schedule

Main window > **Schedules**

Each recurring Task Schedule has its own day pattern.

To configure a recurring Task Schedule:

1. In the **Task Schedules** tree, select a recurring Task Schedule .
2. In the **Recurrence Pattern** field, click the frequency with which you want the Task Schedule to recur (**Daily**, **Weekly**, **Monthly**, **Yearly**) and then make the corresponding settings.
3. In the **Start date:** list, select the appropriate start date.
4. In the **Day Pattern** field, drag the pointer to select the appropriate time period.

Refer to

- *Task Schedules page, page 265*

19.5 Removing a Task Schedule

Main window > > Select an item in the **Task Schedules** tree

To remove a Task Schedule:

1. In the **Task Schedules** tree, select an item.
2. Click **Delete**.

The Task Schedule is deleted. All items that are assigned to this schedule, are not scheduled.

Refer to

- *Task Schedules page, page 265*

19.6 Adding holidays and exception days

Main window > **Schedules**



Notice!

You can configure empty exception days and holidays. Exception days and holidays replace the schedule of the corresponding week day.

Example:

Old configuration:

Weekday schedule configured to be active from 9:00 to 10:00

Exception day schedule configured to be active from 10:00 to 11:00

Result: activity from 10:00 to 11:00

Same behavior is valid for holidays.

You can add holidays and exception days to a Recording Schedule or to a Task Schedule.

Recording Schedules share the same holidays and exception days.

Each standard Task Schedule has its own holidays or exception days patterns.

To add holidays and exception days to a schedule:

1. In the **Recording Schedules** or **Task Schedules** tree, select a schedule.
2. Click the **Holidays** tab.
3. Click **Add**.
The **Add Holiday(s)** dialog box is displayed.
4. Select one or more holidays and click **OK**.
The selected holidays are added to the Schedule Table.
5. Drag the pointer to select the appropriate time period (this is not possible for Recording Schedules).
The selected cells are cleared and vice versa.
6. Click the **Exception Days** tab.
7. Click **Add**.
The **Add Exception Day(s)** dialog box is displayed.
8. Select one or more special days and click **OK**.
The selected exception days are added to the Schedule Table.
9. Drag the pointer to select the appropriate time period (this is not possible for Recording Schedules).
The selected cells are cleared and vice versa.
The sorting order of the added holidays and exception days is chronological.

Notes:

- You can mark a time period on a holiday or exception day of a Recording Schedule with the color of another Recording Schedule.

Refer to

- *Recording Schedules page, page 265*
- *Task Schedules page, page 265*

19.7**Removing holidays and exception days**

Main window > **Schedules**

You can remove holidays and exception days from a Recording Schedule or a Task Schedule.

To remove holidays and exception days from a Task Schedule:

1. In the **Recording Schedules** or **Task Schedules** tree, select a schedule.
2. Click the **Holidays** tab.
3. Click **Delete**.
The **Select the holidays to delete** dialog box is displayed.
4. Select one or more holidays and click **OK**.
The selected holidays are removed from the Schedule Table.
5. Click the **Exception Days** tab.
6. Click **Delete**.
The **Select the exception days to delete** dialog box is displayed.
7. Select one or more exception days and click **OK**.
The selected exception days are removed from the Schedule Table.

Refer to

- *Recording Schedules page, page 265*
- *Task Schedules page, page 265*

19.8**Renaming a schedule**

Main window >

To rename a schedule:

1. In the **Recording Schedules** or **Task Schedules** tree, select an item.
2. Click  .
3. Enter the new name and press ENTER. The entry is renamed.

Refer to

- *Recording Schedules page, page 265*
- *Task Schedules page, page 265*

20

Cameras and Recording page



Notice!

BVMS Viewer offers only basic features. Advanced features are included in BVMS Professional. For detailed information about the different BVMS editions refer to www.boschsecurity.com and the BVMS Quick Selection Guide: [BVMS Quick Selection Guide](#).

Main window > **Cameras and recording**

Displays the Camera Table page or a Recording Table page.

Allows you to configure camera properties and recording settings.

Allows you to filter the cameras that are displayed according to their type.

Icons

	Click to copy recording settings from one Recording Schedule to another.
	Click to display the Stream Quality Settings dialog box.
	Click to display the Scheduled Recording Settings dialog box.
	Click to display the dialog box for configuring a selected PTZ camera.
	Displays all available cameras regardless of their storage device.
	Click to change the Camera Table according to the selected storage device.
	Displays the corresponding Camera Table. No recording settings are available because these cameras are not recorded in BVMS.
	Click to select the columns that should be visible in the Cameras table.

To search for items:

- ▶ In the search field type a string and press the ENTER key to filter the displayed items.

Only items containing the string and their corresponding parent items (only in trees) are displayed. The count of filtered items and the total count of items is provided.

Note: Enclose strings with double quotes to find them exactly, for example "Camera 1" exactly filters the cameras with this name, not camera 201.

20.1

Cameras page

Main window > **Cameras and recording** > Click an icon to change the Cameras page according

to the desired storage device, for example

Displays various information on the cameras available in your BVMS.

Allows you to change the following camera properties:

- Camera name

- Assignment of an audio source
- Logical number
- PTZ control, if available
- Live quality (VRM and Live / Local Storage)
- Recording settings profile
- Minimum and maximum storage time
- Region of Interest (ROI)
- Automated Network Replenishment
- Dual recording

To customize the Cameras table:

1. Click  to select the columns that should be visible in the **Cameras** table.
2. Click a column title to sort the table by this column.

Camera - Encoder

Displays the device type.

Camera - Camera

Displays the name of the camera.

Camera - Network Address

Displays the IP address of the camera.

Camera - Location

Displays the location of the camera. If the camera is not assigned to a Logical Tree yet, **Unassigned Location** is displayed.

Camera - Device Family

Displays the name of the device family to which the selected camera belongs.

Camera - Number

Click a cell to edit the logical number that the camera received automatically when it was detected. If you enter an already used number, a corresponding error message is displayed. The logical number is "free" again when the camera is removed.

Audio

Click a cell to assign an audio source to the camera.

If an alarm occurs with low priority and with a camera that has audio configured, this audio signal is played even when an alarm with higher priority is currently being displayed. But this is only true, if the high priority alarm has no audio configured.

Streams / Stream limits

This column is read only and indicates the stream limits of the respective camera.

Note: Stream limits are only displayed for CPP13 and CPP14 cameras.

Notice!



You can not edit stream limits in BVMS. You can edit them on the encoder web site or in the Configuration Manager. After editing the stream limits on the web site or in the Configuration Manager, you must update the device capabilities in BVMS. If you do not update the device capabilities, BVMS will overwrite the updated stream limits with the old settings that displayed when you updated the device capabilities the last time.

Stream 1 - Codec / Stream 2 - Codec

Click a cell to select the desired codec for encoding the stream.

Stream 3 - Codec

Click a cell to select the desired video resolution.

The values for video resolution are loaded from the encoder. Displaying those values may take a while.

Note: Only CPP13 and CPP14 cameras support a third stream. This column only displays if you have at least one camera configured that supports a third stream.

Stream 1 - Quality / Stream 2 - Quality / Stream 3 - Quality

Select the desired quality of the stream used for live or recording. You configure quality settings in the **Stream Quality Settings** dialog box.

Stream 1 - Active platform / Stream 2 - Active platform / Stream 3 - Active platform

Shows the name of the platform settings within the **Stream Quality Settings** dialog box. This column is read only and indicates which profile settings will be written to the encoder.



Notice!

You can use stream 3 only for live display. Recording is not possible.

Live Video - Stream (only VRM and Live Only and Local Storage)

Click a cell to select the stream for a VRM or a local storage / live only encoder.

Live Video - Profile (only available for ONVIF cameras)

Click a cell to browse for the available live profile tokens of this ONVIF camera.

If you select the **<Automatic>** entry, the stream with the highest quality is automatically used.

Note: If you select a Video Streaming Gateway device for retrieving the live video in a workstation, the **Live Video - Profile** setting is obsolete. Instead, the **Recording - Profile** setting is also used for live video.

Live Video - ROI

Click to enable Region of Interest (ROI). This is only possible if in the **Quality** column the H.264 MP SD ROI or H.265 MP SD ROI item is selected for stream 2 and stream 2 is assigned to Live Video.

Note: If stream 1 is used for Live for a specific workstation then the Operator Client running on this workstation cannot enable ROI for this camera.



is automatically enabled in the  table.

Recording - Setting

Click a cell to select the required recording setting. You configure the available recording settings in the **Scheduled Recording Settings** dialog box.

Recording - Profile (only available for ONVIF cameras)

Click a cell to browse for the available recording profile tokens of this ONVIF camera. Select the desired entry.

Recording - ANR

Select a check box to enable the ANR function. You can only enable this function, if the encoder has an appropriate firmware version and an appropriate device type.

Recording - Max Pre-Alarm Duration

Displays the calculated maximum pre-alarm duration for this camera. This value can help you in calculating the required storage capacity of the local storage medium.



Notice!

If a Mirrored VRM is already configured for an encoder, you cannot change any settings for this encoder in the **Secondary Recording** columns.

Secondary Recording - Setting (only available if a Secondary VRM is configured)

Click a cell to assign a scheduled recording setting to the dual recording of this encoder. Depending on your configuration it can happen that the configured stream quality for secondary recording is not valid. The stream quality configured for primary recording is then used instead.

Secondary Recording - Profile (only available for ONVIF cameras)

Click a cell to browse for available recording profile tokens of this ONVIF camera.



(Only visible when you click  All)

Select a check box to activate PTZ control.

Note:

For port settings refer to COM1.

Port (Only visible when you click  All)

Click a cell to specify which encoder serial port is used for PTZ control. For a PTZ camera connected to a Bosch Allegiant system, you can select **Allegiant**. For such a camera you do not need to use a trunk line.

Protocol (Only visible when you click  All)

Click a cell to select the appropriate protocol for the PTZ control.

PTZ Address (Only visible when you click  All)

Type the address number for the PTZ control.

Recording - Storage Min Time [days]**Secondary Recording - Storage Min Time [days] (only VRM and Local Storage)**

Click a cell to edit the minimum number of days that video data from this camera is retained. Recordings younger than this number of days are not deleted automatically.

Recording - Storage Max Time [days]**Secondary Recording - Storage Max Time [days] (only VRM and Local Storage)**

Click a cell to edit the maximum number of days that video data from this camera is retained. Only recordings older than this number of days are deleted automatically. 0 = unlimited.

Refer to

- *Configuring dual recording in the Camera Table, page 287*
- *Configuring predefined positions and auxiliary commands, page 284*
- *Configuring PTZ port settings, page 284*
- *Configuring stream quality settings, page 277*
- *Copying and pasting in tables, page 276*
- *Configuring the ANR function, page 287*
- *Exporting the Camera Table, page 277*
- *Assigning an ONVIF profile, page 287*
- *Configuring the ROI function, page 286*

20.2

Recording settings pages

Main window > **Cameras and recording** >  > Click a Recording Schedule tab (for example



Allows you to configure the recording settings.

The displayed Recording Schedules are configured in **Schedules**.

Only those columns are described that are not part of a camera table.

- ▶ Click a column title to sort the table by this column.

Continuous Recording

In the **Quality** column, click a cell to disable recording or to select the stream quality of stream 1.

In the  column, select a check box to activate audio.

Live/Pre-event Recording

In the **Quality** column, click a cell to select the stream quality of the live view (required for instant playback) and the pre-event recording (required for motion and alarm recording) mode of stream 2. If dual streaming is active on this encoder, you can select stream 1 to use for live or pre-event recording.

In the  column, select a check box to activate audio.

Motion Recording

In the **Quality** column, click a cell to disable recording or to select the stream quality of stream 1.

In the  column, click a cell to activate audio.

In the **Pre-event [s]** column, click a cell to select the recording time before the motion event in seconds.

In the **Post-event [s]** column, click a cell to select the recording time after the motion event in seconds.

Alarm Recording

In the **Quality** column, click a cell to select the stream quality of stream 1.

To enable alarm recording, configure a corresponding alarm.

In the  column, select a check box to activate audio.

In the **Pre-event [s]** column, click a cell to select the time before the alarm in seconds.

In the **Post-event [s]** column, click a cell to select the time after the alarm in seconds.

Refer to

- *Copying and pasting in tables, page 276*

21 Configuring cameras and recording settings





Notice!

This document describes some functions that are not available for BVMS Viewer. For detailed information about the different BVMS editions refer to www.boschsecurity.com and the BVMS Quick Selection Guide: [BVMS Quick Selection Guide](#).

Main window > **Cameras and recording**

This chapter provides information on how to configure the cameras in your BVMS. You configure various camera properties and the recording settings.

- Click  to save the settings.
- Click  to undo the last setting.
- Click  to activate the configuration.

Refer to

- *Cameras page, page 271*
- *Scheduled Recording Settings dialog box (only VRM and Local Storage), page 282*
- *Stream Quality Settings dialog box, page 278*
- *Predefined positions and AUX commands dialog box, page 285*

21.1 Copying and pasting in tables

You can configure many objects simultaneously within a Camera Table, an Event Configuration Table, or an Alarm Configuration Table.

You can copy the configurable values of a table row in other rows:

- Copy all values of a row to other rows.
- Copy only one value of a row to another row.
- Copy the value of one cell to a complete column.

You can copy the values in two different ways:

- Copy into the clipboard and then paste.
- Direct copy and paste.

You can determine in which rows to paste:

- Copy in all rows.
- Copy in selected rows.

To copy and paste all configurable values of a row into another row:

1. Right-click the row with the desired values and click **Copy Row**.
2. Click the row heading of the row that you want to modify.
To select more than one row press the CTRL key and point to the other row headings.
3. Right-click the table and click **Paste**.
The values are copied.

To copy and paste one value of a row into another row:

1. Right-click the row with the desired values and click **Copy Row**.
2. Right-click the cell that you want to modify, point to **Paste Cell to**, and click **Current Cell**.
The value is copied.

To copy all configurable values directly:

1. Click the row heading of the row that you want to modify.
To select more than one row press the CTRL key and point to the other row headings.

- Right-click the row with the desired values, point to **Copy Row to**, and click **Selected Rows**.

The values are copied.

To copy one value directly:

- Click the row heading of the row that you want to modify.
To select more than one row press the CTRL key and point to the other row headings.
- Right-click the cell with the desired value, point to **Copy Cell to**, and click **Selection in Column**.

The value is copied.

To copy a value of a cell to all other cells in this column:

- Right-click the cell with the desired value, point to **Copy Cell to**, and click **Complete Column**.

The value is copied.

To duplicate a row:

- Right-click the row and click **Add Duplicated Row**.

The row is added below with a new name.

Refer to

- Cameras page, page 271*
- Scheduled Recording Settings dialog box (only VRM and Local Storage), page 282*
- Events page, page 289*
- Alarms page, page 294*

21.2 Exporting the Camera Table

Main window > **Cameras and recording**

Or

Main window > **Cameras and recording** > Click an icon to change the Cameras page according



to the desired storage device, for example

Displays various information on the cameras available in your BVMS.

You can export the Camera Table into a CSV file.

To export:

- Right-click anywhere in the Camera Table and click **Export table...**
- In the dialog box, type in an appropriate filename.
- Click **Save**.

The selected Camera Table is exported in a csv file.

21.3 Configuring stream quality settings

To add a stream quality settings entry:

- Click  to add a new entry in the list.
- Type in a name.

To remove a stream quality settings entry:

- Select an entry in the list and click  to delete the entry.
You cannot delete default entries.

To rename a stream quality settings entry:

- Select an entry in the list.

2. Enter the new name in the **Name** field.
You cannot rename default entries.
3. Click **OK**.

To configure stream quality settings:

1. Select an entry in the list.
2. Make the appropriate settings.

21.3.1 Stream Quality Settings dialog box

Main window > **Cameras and recording** > 

Allows you to configure stream quality profiles that you can later assign on the **Cameras and recording** page to cameras or in the **Scheduled Recording Settings** dialog box.

A stream quality combines video resolution, frame rate, maximum bandwidth, and video compression.

Stream Qualities



Select a predefined stream quality and click  to add a new stream quality on the

basis of the predefined stream quality. When you select a single stream and click , this stream quality setting is copied as a childless top level node.



Click to delete a selected stream quality. You cannot delete the stream quality settings.

The list displays all available predefined stream quality settings. We recommend assigning a stream quality with the same name as the platform of the camera.

The following profiles for stream qualities are available:

Image optimized: The settings are optimized for image quality. This can burden the network.

Bit rate optimized: The settings are optimized for low bandwidth. This can reduce the image quality.

Balanced: The settings offer a compromise between optimal image quality and optimal bandwidth usage.

The following profiles for stream qualities are available since BVMS 9.0 to support the Intelligent Streaming feature of Bosch cameras:

Cloud optimized 1/8 FR: The settings are optimized for low bandwidth and identically for all camera types.

PTZ optimized: The settings are optimized for PTZ cameras.

Image optimized quiet / standard / busy

Bit rate optimized quiet / standard / busy

Balanced quiet / standard / busy

Scene type categories:

quiet: The settings are optimized for images with low activity. 89% static scene, 10% normal scene, 1 % busy scene.

standard: The settings are optimized for images with medium activity. 54% static scene, 35% normal scene, 11 % busy scene.

busy: The settings are optimized for images with high activity. 30% static scene, 55% busy scene, 15% crowded scene.

The percentage values are related to a distribution during a day.

By default the Balanced standard profile is assigned.



Notice!

For each combination of camera platform (CPP3-CPP7.3) and for each of the available resolutions a specific setting exists to be able to set the correct bit rates for the cameras. The profile has to be selected manually with the corresponding scene type for each camera.



Notice!

If doing an update installation the new profiles have to be selected manually to become active. The old profiles remain.

Name

Displays the name of the stream quality. When you add a new stream quality, you can change the name.

SD video resolution

This setting is only applicable when the codec of the stream is set to SD resolution.

Select the desired video resolution. For an HD quality you configure the SD quality of stream 2.

Note: There is no impact on the resolution when the codec is configured as HD or UHD resolution (any higher than SD codec). The resolution of , for example, a HD camera cannot be reduced to SD with this setting.

Image encoding interval

Move the slider or type the appropriate value.

The system helps you in calculating the corresponding value for IPS.

With the **Image encoding interval** you configure the interval at which images are encoded and transmitted. If 1 is entered, all images are encoded. Entering 4 means that only every fourth image is encoded, the following three images are skipped - this can be particularly advantageous with low bandwidths. The lower the bandwidth the higher this value should be to achieve best-quality video.

The encoding engine gets for example 30 frames from the sensor as input. Required output for the live view or recording is 15 frames.

To achieve this:

- ▶ Set the **Image encoding interval** parameter to 2.
The encoder will skip every second frame from the sensor and deliver a H.264 encoded stream with 15 frames only.

Image encoding interval:

- 1= full frame rate as given in codec settings
- 2= 50% of fps given in codec settings

For quick frame rate calculations the formula is: $IPS = \text{sensor mode} / \text{image encoding interval}$

GOP structure

Select the structure you require for the Group-of-Pictures (GOP). Depending on whether you place higher priority on having the lowest possible delay (IP frames only) or using as little bandwidth as possible, you choose IP, IBP or IBBP. (GOP selection is not available on some cameras.)

Note:

B-frames are only supported by cameras up to a resolution of 1080 p and from firmware 6.40. Avoid B-frames in live view and for PTZ as they result in live video latency.

Bit Rate Optimization

Bit rate optimization refers to the priority given towards image quality or bit rate reduction. The **High quality** or **Maximum quality** provides less or no bitrate saving, but a good to excellent picture.

Low bit rate and **Medium** bit rate save more bandwidth, but the resulting image may provide less details.

If bit rate optimization is set off, an averaging bit rate of 24 h is expected (higher than the target bit rate).

Target bit rate [Kbps]

Move the slider or type the appropriate value.

You can limit the data rate for the encoder to optimize usage of bandwidth in your network. The target data rate should be set according to the desired picture quality for typical scenes with no excessive motion.

For complex images or frequent changes of image content due to frequent movements, this limit can be temporarily exceeded up to the value you enter in the **Maximum bit rate [Kbps]** field.

Maximum bit rate [Kbps]

Move the slider or type the appropriate value.

With the maximum bit rate you configure the maximum transmission speed which cannot be exceeded.

You set a bit rate limit to be able to reliably determine the appropriate disk space for storage of the video data.

Depending on the video quality settings for the I- and P-Frames, this fact can result in individual images being skipped.

The value entered here must be at least 10% higher than the value entered in the **Target bit rate [Kbps]** field. If the value entered here is too low, it will automatically be adjusted.

I-frame Distance

This parameter allows you to set the intervals in which the I-Frames are coded.

An entry of 1 indicates that I-Frames are continuously generated. An entry of 10 indicates that only every tenth image is an I-Frame, and 60 only every sixtieth image etc. The I-Frames in between are coded as P-Frames.

Note: When using a very long GOP (up to 255), combined with a low frame-rate (1fps), the time distance between the I-frames is too large and playback cannot be displayed. We recommend to reduce the GOP length to 30.

Frame Quality Level

Here you can set a value between 0 and 100 for both the I-Frames and the P-Frames. The lowest value results in the highest quality and the lowest frame refresh rate. The highest value results in the highest frame refresh rate and the lowest image quality.

The lower the available transmission bandwidth, the higher adjust the quality level to maintain high quality of the video.

Note:

If not instructed by technical support, we highly recommend to select the **Automatic** check boxes. The optimum relationship between motion and image definition is then automatically adjusted.

VIP X1600 XFM4 Settings

Allows you to configure the following H.264 settings for the VIP X 1600 XFM4 encoder module.

H.264 deblocking filter: Select to improve visual quality and prediction performance by smoothing the sharp edges.

CABAC: Select to activate high efficient compression. Uses a large amount of processing power.

Refer to

– *Configuring stream quality settings, page 277*

21.4 Configuring camera properties

Main window > **Cameras and recording** > 

To change camera properties:

1. In the **Camera** column, click a cell and type a new name for the camera.
This name is displayed in all other places where cameras are listed.
2. Make the appropriate settings in the other columns.

For detailed information on the various fields, follow the link to the appropriate application window below.

Refer to

– *Cameras page, page 271*



21.5 Configuring recording settings (only VRM and Local Storage)

Main window > **Cameras and recording** > 

You can configure the recording settings of all devices that are added to the VRM Devices item in the Device Tree.

Note: For recording, ensure that the corresponding VRM or local storage is properly configured.

VRM: **Devices** > Expand  > 

Local Storage: **Devices** > Expand  > 

To add a recording settings entry:

1. Click  to add a new entry in the list.
2. Type in a name.

To remove a recording settings entry:



- ▶ Select an entry in the list and click  to delete the entry.
You cannot delete default entries.

To rename a recording settings entry:

1. Select an entry in the list.
2. Enter the new name in the **Name:** field.
You cannot rename default entries.
3. Click **OK**.

To configure recording settings:

1. Select an entry in the list.
2. Make the appropriate settings and click **OK**.

3. Click  or  .
4. In the **Recording** column, select the desired recording setting for each encoder. For detailed information on the various fields, see the Online Help for the appropriate application window.

Refer to

- *Scheduled Recording Settings dialog box (only VRM and Local Storage), page 282*

21.6 Scheduled Recording Settings dialog box (only VRM and Local Storage)

Main window > **Cameras and recording** > 

Allows you to configure schedule-dependent recording settings for each available device family. A device family is available when at least one encoder of this device family has been added to the Device Tree. In the **Cameras** table, you assign such a recording setting to each camera.

You use the Recording Schedules configured on the **Schedules** page.

Note: Switching on or off the normal recording is valid for all device families.

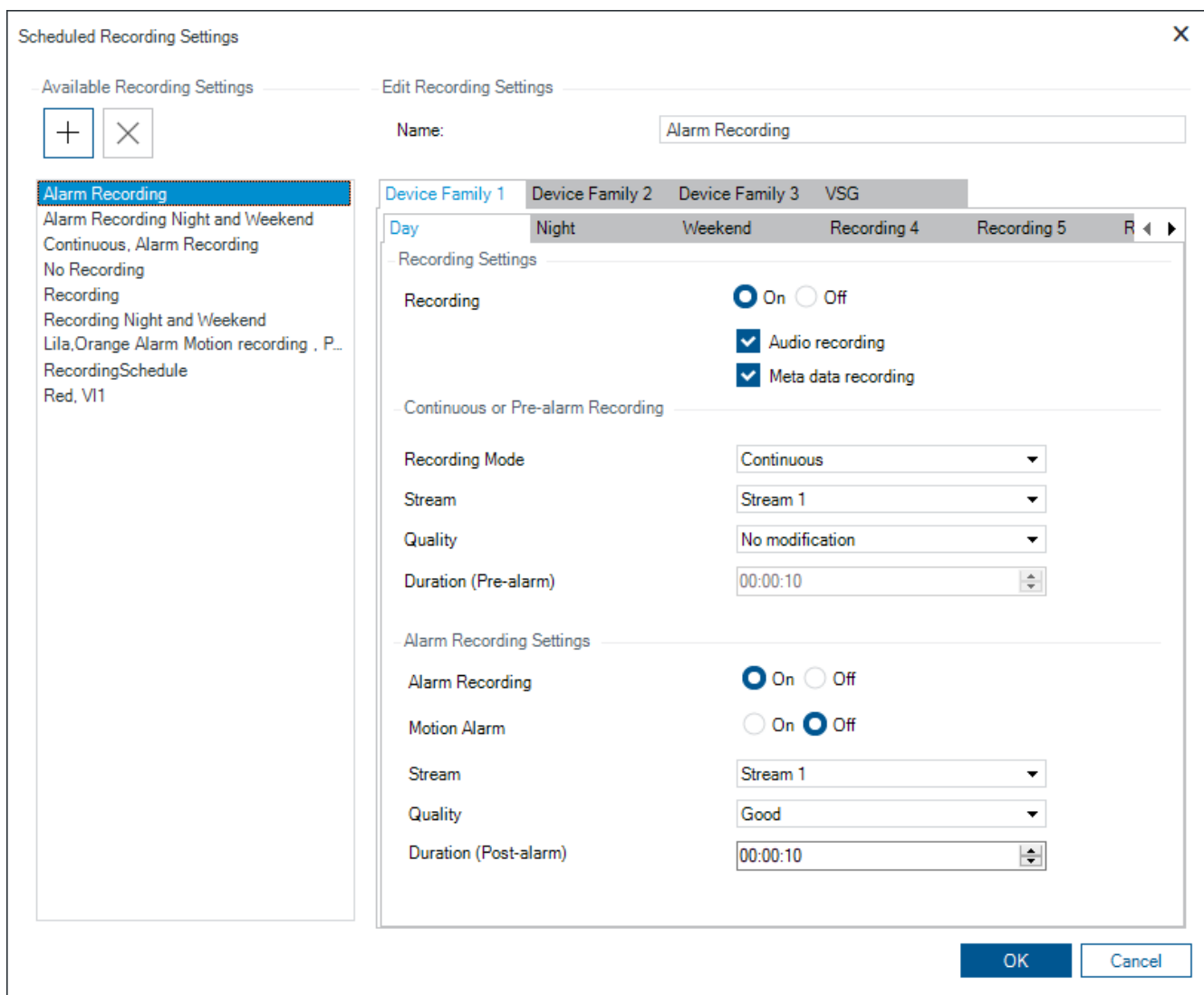

Available Recording Settings

Select a pre-defined recording setting to change its properties. You can add or delete a user-defined setting.

Name:

Type in a name for the new recording setting.

Device family tab

Select the desired device family to configure the recording settings valid for this device family.

Recording schedule tab

For the selected device family, select a recording schedule to configure the recording settings.

Recording

Switch on or off the normal recording (continuous and prealarm).

Audio recording

Select, if you want to record audio.

Meta data recording

Select, if you want to record metadata.

Recording Mode

Select the desired recording mode.

The following items are available:

- **Continuous**
- **Pre-alarm**

Stream

Select the desired stream used for normal recording.

Note: It depends on the device family which streams are available.

Quality

Select the desired stream quality used for normal recording. The available quality settings are configured in the **Stream Quality Settings** dialog box.

Duration (pre-alarm)

Enter the desired recording time before an alarm. You enter the time in the format hh.mm.ss.

Note: Only enabled when **Pre-alarm** is selected.



Notice!

For pre-alarm settings between 1 and 10 s, the pre-alarms are automatically stored on the RAM of the encoder if enough RAM space is available, otherwise on the storage.

For pre-alarm settings greater than 10 s, pre-alarms are stored on the storage.

The storage of pre-alarms on the RAM of the encoder is only available for firmware version 5.0 or later.

Alarm Recording Settings

Allows you to switch on or off the alarm recording for this camera.

Motion Alarm

Allows you to switch on or off alarm recording triggered by motion.

Stream

Select the stream used for alarm recording.

Note: It depends on the device family which streams are available.

Quality

Select the desired stream quality used for alarm recording. The available quality settings are configured in the **Stream Quality Settings** dialog box.

Only for devices belonging to Device Family 2 or 3: When you select the **No modification** entry, alarm recording uses the same quality as used for continuous/prealarm recording. We recommend using the **No modification** entry. When you select a stream quality for alarm recording, only the values for image encoding interval and target bit rate are modified according to the settings in this stream quality. The other quality settings are used that are configured in the quality setting assigned to the continuous/prealarm recording.



Duration (post-alarm)

Enter the desired alarm recording time. You enter the time in the format hh.mm.ss.

Refer to

- *Copying and pasting in tables, page 276*
- *Configuring recording settings (only VRM and Local Storage), page 281*

21.7 Configuring PTZ port settings

Main window > **Devices** > Expand  > Expand  >  > **Interfaces** tab > **Periphery** tab

Main window > **Devices** >  >  > **Interfaces** tab > **Periphery** tab

You can only configure port settings for an encoder where the control of the camera is available and activated.

When the encoder or PTZ camera is exchanged, the port settings are not retained. You must again configure them.

After a firmware update check the port settings.

To configure the port settings of an encoder:

- ▶ Make the appropriate settings.
 - The settings are valid immediately after saving. You do not have to activate the configuration.

For detailed information on the various fields, see the Online Help for the appropriate application window.

21.8 Configuring predefined positions and auxiliary commands

Main window > **Cameras and recording** > 

You can predefine and save camera positions for PTZ, ROI and panoramic cameras. For PTZ cameras you can also define auxiliary commands.

Note: First configure the port settings of your PTZ camera before you can configure the PTZ camera settings. Otherwise the PTZ control is not working in this dialog box.

To configure a predefined position:

1. In the **Cameras** table, select the required encoder.
2. Only for PTZ cameras: to activate the control of a PTZ camera, select the check box in the

 column.

3. Click the  button.

The **Predefined positions and AUX commands** dialog box is displayed.

4. You can define the number of predefined positions that you want to use.
5. Select the position you want to define.

6. In the preview window, use the mouse control to navigate to the position you want to configure.
Scroll to zoom in and out and drag to move the image section.
7. If required, type a name for the configured position.

8. Click  to save the predefined position.

Note: Click  for each defined position. Otherwise the position is not saved.

9. Click **OK**.

To display already configured predefined positions:

1. In the **Cameras** table, select the required encoder.
2. Click the  button.
The **Predefined positions and AUX commands** dialog box is displayed.
3. Select the appropriate position.

4. Click .
The predefined camera position is displayed in the preview window.

Note:

Predefined positions for PTZ and ROI cameras are stored on the camera directly. Predefined positions for panoramic cameras are stored in BVMS.

PTZ cameras move physically to the predefined position. Panoramic and ROI cameras only display an image section of the complete camera view.

To configure auxiliary commands for PTZ cameras:

1. In the **Cameras** table, select the required encoder.
2. Click the  button.
The **Predefined positions and AUX commands** dialog box is displayed.
3. Select the **Aux Commands** tab.
4. Make the appropriate settings.

5. Click  to save the predefined commands.

For detailed information on the various fields, see the Online Help for the appropriate application window.

Refer to

- *Predefined positions and AUX commands dialog box, page 285*
- *Configuring PTZ port settings, page 284*
- *Configuring an alarm, page 306*
- *Select Image Pane Content dialog box, page 295*
- *Alarm Options dialog box, page 297*
- *Select Image Pane Content dialog box (MG), page 296*

21.9

Predefined positions and AUX commands dialog box



Main window > **Cameras and recording** >  > Select a PTZ, ROI or panoramic camera >



Allows you to configure a PTZ, ROI or panoramic camera.
 For ROI and panoramic cameras no auxiliary commands are available.

Note: First configure the port settings of your PTZ camera before you can configure the PTZ camera settings. Otherwise the PTZ control is not working in this dialog box.

Icons

	Click to move the camera to the predefined position or to execute the command.
	Click to save the predefined position or command.

Predefined positions tab

Click to display the table with the predefined positions.

Nr

Displays the number of the predefined position.

Name

Click a cell to edit the name of the predefined position.

Aux Commands tab (only for PTZ cameras)

Click to display the table with the auxiliary commands.

Note: If an ONVIF encoder supports auxiliary commands, the auxiliary commands are provided from the ONVIF encoder directly.

Nr

Displays the number of the auxiliary command.

Name

Click a cell to edit the name of the command.

Code

Click a cell to edit the command's code.

Refer to

- *Configuring PTZ port settings, page 284*
- *Configuring predefined positions and auxiliary commands, page 284*

21.10 Configuring the ROI function



Main window > **Cameras and recording** > 

You can enable the ROI function for a fixed HD camera.

You must configure stream 2 for live video and you must configure the H.264 MP SD ROI or H.265 MP SD ROI codec for stream 2.

Ensure that stream 2 is used for live video on each workstation where ROI is to be used.

To enable ROI:

1. In the **Stream 2 - Codec** column, select the H.264 MP SD ROI or H.265 MP SD ROI codec.
2. In the **Live Video - Stream** column, select **Stream 2**.
3. In the **Live Video - ROI** column, click to select the check box.

To disable ROI:

1. In the **Live Video - ROI** column, click to disable the check box.
2. In the **Stream 2 - Codec** column, select the desired codec.

Refer to

- *Cameras page, page 271*

21.11 Configuring the ANR function



Main window > **Cameras and recording** >

Before you enable the ANR function, you must add the storage media of an encoder to the desired encoder and configure this storage media.

You must disable dual recording for the encoder to configure ANR.

The ANR function only works on encoders with firmware version 5.90 or later. Not all encoder types support ANR even if the correct firmware version is installed.

To enable:

- ▶ In the row of the desired camera, in the **ANR** column, select the checkbox.

Refer to

- *Configuring dual recording in the Camera Table, page 287*
- *Cameras page, page 271*
- *Configuring the storage media of an encoder, page 219*

21.12 Configuring dual recording in the Camera Table



Main window > **Cameras and recording** >

You must disable the ANR function to configure dual recording.

If you configure dual recording for one camera of a multi-channel encoder, the system ensures that the same recording target is configured for all cameras of this encoder.

To configure:

1. In the **Secondary Recording - Target** column, click a cell of the desired encoder and then click the desired pool of a Secondary VRM.
Automatically all cameras of the affected encoder are configured to be recorded to the selected Secondary VRM.
2. In the **Setting** column, select a scheduled recording setting.

Refer to

- *Configuring dual recording in the Device Tree, page 183*
- *Configuring the ANR function, page 287*
- *Dual / failover recording, page 28*
- *Cameras page, page 271*

21.13 Managing Video Streaming Gateway

Refer to

- *Video Streaming Gateway device page, page 193*
- *Add Bosch Encoder dialog box, page 196*
- *Add ONVIF Encoder dialog box, page 197*
- *Add JPEG Camera dialog box, page 199*
- *Add RTSP Encoder dialog box, page 200*

21.13.1 Assigning an ONVIF profile



Main window > **Cameras and recording** >

You can assign an ONVIF Media Profile token to an ONVIF camera.
You can assign either for live video or for recording.

To assign a live video token:

- ▶ In the **Live Video - Profile** column, select the desired entry.

To assign a recording token:

- ▶ In the **Recording - Profile** column, select the desired entry.

Refer to

- *Cameras page, page 271*

22

Events page

Main window > **Events**

Displays the Event Tree with all available events and an Event Configuration Table for each event. The events are grouped by their type, for example, all camera recording events like continuous recording or alarm recording are grouped under Recording Mode.

The available events are grouped beyond their corresponding devices. A state change of a

device is displayed beyond  as . All other events are displayed under device

dependant groups as .

You can configure for each event:

- Trigger an alarm according to a schedule (not available for all events).
- Log the event according to a schedule. An event is displayed in the Event List of the Operator Client if it is logged.
- Execute a Command Script according to a schedule (not available for all events).

- For events of type : Adding text data to recording.

If the event occurs, your settings are executed.

You can create a Compound Event which combines several events with Boolean expressions.

- ▶ Click a tree item to display the corresponding Event Configuration Table.



Click to duplicate an event. Use it to generate multiple alarms for a certain event.



Click to delete a duplicated or a Compound Event.



Click to rename the selected Compound Event.



Click to display a dialog box for creating Compound Events using Boolean expressions of other events (maximum 10).

Compound Events are added to the Event Configuration Table.



Click to edit the selected Compound Event.



Click to display a dialog box for creating and editing Command Scripts.

To search for items:

- ▶ In the search field type a string and press the ENTER key to filter the displayed items.

Only items containing the string and their corresponding parent items (only in trees) are displayed. The count of filtered items and the total count of items is provided.

Note: Enclose strings with double quotes to find them exactly, for example "Camera 1" exactly filters the cameras with this name, not camera 201.

Refer to

- *Configuring events and alarms, page 302*
- *Configuring Command Scripts, page 90*
- *Options dialog box (Settings menu), page 119*
- *Configuring blinking hotspots, page 309*

22.1 Debounce Settings tab

Note: For some events the Debounce Settings tab is not available due to technical limitations. Allows you to configure debounce settings for the selected event.

Debounce time

During the entered time period all further events are ignored.

Event state priority

For an event state you can assign a priority setting.

Edit Priorities

Click to display a dialog box for configuring a priority setting.

Add Setting



Click to add a row for configuring a debounce setting that is deviating from the debounce settings for all devices.

Remove Setting



Click to remove a selected row. To select a row click the left row header.

22.2 Settings tab for advanced map display

The configuration of the color states on maps is only possible when you click to check the **Enabled advanced state display (hot spot coloring in maps depending on state)** option or the **Enabled advanced state display (hot spot coloring in maps depending on alarm)** option in the **Options** dialog box.

For each  event or alarm, you can configure the background color and the behavior (blinking or not blinking) for hotspots. For example you can configure for a  event or alarm of a device that its device icon on a map starts blinking when the state of this device changes.

Additionally you can configure the display priority for all hotspots. This is required when different events occur for the same device. (1 = highest priority)

The configured color is valid for all hotspots with the same display priority. You can change color, behavior and priority at any  event or alarm: The changed color and behavior is used for all hotspots of all other  events or alarms which have the same priority.

Enable color states on maps

Click to enable that the hotspots of the devices belonging to this event are displayed with colored background and can blink on maps.

Display priority on map:

Click the arrows to change the priority for the hotspots of the devices belonging to this event.

Background color on map:

Click the color field to select the background color used for the hotspots of the devices belonging to this event.

Note: All state events of all devices with the same priority have the same color.

Blinking

Click to enable blinking of the hotspots of the devices belonging to this event.

22.3 Settings tab for event configuration

Device

Displays the name of the device or schedule.

Network

Displays the IP address of the corresponding IP device.

Trigger Alarm

Click a cell to select a Recording or Task Schedule for triggering an alarm.

Select **Always** if you want the alarm to be triggered independently from the point in time.

Select **Never** if you do not want the alarm to be triggered.

Log

In the **Schedule** column, click a cell to select a Recording or Task Schedule for logging.

Select **Always** if you want the event to be logged independently from the point in time.

Select **Never** if you do not want the event to be logged.

Script

In the **Script** column, click a cell to select a Command Script.

In the **Schedule** column, click a cell to select a Recording or Task Schedule for executing a Command Script.

Select **Always** if you want the Command Script to be executed independently from the point in time.

Select **Never** if you do not want the Command Script to be executed.

Text Data Recording

You can configure that text data is added to the continuous recording of a camera.

Note: This column is available only for events that contain text data, for example: **ATM/POS Devices > ATM Input > Data Input**

22.4 Command Script Editor dialog box

Main window > **Events** > 

Allows you to create and edit Command Scripts.



Click to save the changed settings.



Click to restore the saved settings.



Click to check the code of a script.



Click to create a scriptlet file.



Click to delete a scriptlet file.



Click to display a dialog box for importing a script file.



Click to display a dialog box for exporting a script file.



Click to convert an existing script to the other available script language. All existing script text is deleted.



Click to display the Online Help for BVMS Script API.



Click to display the Online Help for BVMS.

✕ Click to close the **Command Script Editor** dialog box.

Refer to

– *Configuring Command Scripts, page 90*

22.5 Create Compound Event / Edit Compound Event dialog box

Main window > **Events** > 

Allows you to create or modify a Compound Event.

To search for items:

- ▶ In the search field type a string and press the ENTER key to filter the displayed items.

Only items containing the string and their corresponding parent items (only in trees) are displayed. The count of filtered items and the total count of items is provided.

Note: Enclose strings with double quotes to find them exactly, for example "Camera 1" exactly filters the cameras with this name, not camera 201.

Event name:

Type the required name for the Compound Event.

Event States:

Select the state change that shall be part of a Compound Event.

Objects:

Select one or more of the available objects of the selected event state. This state and the selected object appear in the Compound Event Tree, as immediate child of the root operator.

Compound Event:

Allows you to build compound events in the Compound Event Tree. All immediate children of a Boolean operator (AND, OR) are combined by this operator.

Refer to

- *Creating a Compound Event, page 305*
- *Editing a Compound Event, page 306*

22.6 Select Script Language dialog box

Main window > **Events** > 

Allows you to set the script language for your Command Scripts.

You cannot change the script language for existing Command Scripts.

Script Language:

Select the required script language.

Refer to

- *Configuring Command Scripts, page 90*

22.7 Edit Priorities of Event Type dialog box

Main window > **Events** > **Debounce Settings** tab > **Edit Priorities** button

You can configure priorities for the different state changes of an event type if applicable, for example Virtual Input Closed and Virtual Input Opened. A state change with higher priority overrides the debounce time of another state change with lower priority.

Name of Priority:

Type in a name for the priority setting.

State Value

Displays the names of the event states of the select event.

State Priority

Enter the desired priority. 1=highest priority, 10=lowest priority.

22.8

Select Devices dialog box

Main window > **Events** >  or  > **Debounce Settings** tab > **Add Setting** button

Select

Select the check box for the desired entry and click **OK** to add a row in the **Devices with Deviating Debounce Settings** table.

22.9

Text Data Recording dialog box

Main window > **Events** > In the Event Tree select  **Data Input** (text data must be available, for example: **Foyer Card Reader Devices** > **Foyer Card Reader** > **Card Rejected**) > **Text Data Recording** column > ...

You can configure the cameras for which text data is added to the continuous recording.

Refer to

- *Triggering alarm recording with text data, page 307*

23

Alarms page

Main window > **Alarms**

Displays the Event Tree and an Alarm Configuration Table for each event. Only the events configured on the **Events** page are displayed.

In the tables you configure for each event how an alarm triggered by this event is displayed and which cameras are recorded and displayed when this alarm occurs.

Some events are configured as alarms by default, e.g., a system error.

For the following events you cannot configure an alarm:

- Change of a recording mode
- Change of an alarm state
- Most of the user actions, e.g. PTZ action



Click to display the **Resource Manager** dialog box.



Displays a dialog box to set alarm settings valid for this Management Server.

To search for items:

- ▶ In the search field type a string and press the ENTER key to filter the displayed items.

Only items containing the string and their corresponding parent items (only in trees) are displayed. The count of filtered items and the total count of items is provided.

Note: Enclose strings with double quotes to find them exactly, for example "Camera 1" exactly filters the cameras with this name, not camera 201.

- ▶ Click a tree item to display the corresponding Alarm Configuration Table.

Device

Displays the device of the event condition selected in the Events Tree.

Network address

Displays the IP address of the corresponding IP device.

Alarm identity

In the **Priority** column, click in a cell to type the alarm priority for the selected alarm (**100** is low priority, **1** is high priority). In the **Title** column, click in a cell to type the title of the alarm to be displayed in BVMS, for example in the Alarm List. In the **Color** column, click in a cell to display a dialog box for selecting a color for the alarm to be displayed in the Operator Client, for example in the Alarm List.

Alarm image panes

In one of the **1-5** columns, click ... in a cell to display a dialog box for selecting a camera.

You can only select a camera that was added to the Logical Tree in **Maps and structure**.

You can configure the number of available Alarm Image panes in the **Alarm Settings** dialog box.

In the **Audio File** column, click ... in a cell to display a dialog box for selecting an audio file that is played in case of an alarm.

Alarm Options

Click ... in a cell to display the **Alarm Options** dialog box.

Refer to

- *Alarm handling, page 40*

23.1 Alarm Settings dialog box

Main window > **Alarms** > 

Alarm Settings tab

Max. image panes per alarm:

Enter the maximum count of alarm image panes to be displayed in case of an alarm.

Note: If operating an Enterprise System, the highest maximum count that is configured on the online Management Servers, applies.

Auto-clear time:

Enter the number of seconds until an alarm is automatically cleared.

This only applies for alarms that are set to **Auto-clear alarm after configured time ('Alarm Settings' dialog box)** in the **Alarms** page.

Multi-row alarm display in alarm image window

Select the check box to enable the multi-row alarm display of the alarm image window.



Notice!

For existing alarm configurations the multi-row alarm display is on, for new alarm configurations the default value is off and the single view display is active.

Set the duration limit for state-triggered alarm recordings:

Select the check box to enable a duration limit for state-triggered alarm recordings. Enter the number of minutes for the duration of alarm recording. The alarm recording stops automatically after the defined time.

The user can enter a duration time between 1 and 1440 minutes.

When an alarm triggers a recording with a configured duration limit:

- If the alarm is retriggered before the timeout is reached, then the recording continues with the timeout restarting from 0.
- If the alarm is cancelled before the timeout is reached, then the recording continues to the configured post alarm timeout.

Monitor groups tab

Display order in case of same alarm priority

Select the desired entry for sorting alarms of the same priority according to their time stamp.

Show blank screen

Click to configure that on a monitor not being used for alarm display nothing is shown.

Continue live display

Click to configure that on a monitor not being used for alarm display live display is shown.

Refer to

- *Configuring settings for all alarms, page 306*

23.2 Select Image Pane Content dialog box

Main window > **Alarms** >  or  > **Alarm image panes** column > Click ... in one of the **1-5** columns

Allows you to select the Logical tree item that is displayed and recorded (if the item is a camera) in case of the selected alarm.

**Notice!**

A site map displayed in an alarm image pane is optimized for display and contains only the initial view of the original map file.

Search Item

Enter text to find an item in the Logical Tree.

Find

Click to find the camera with the entered search text in its description.

Live

Click to determine that the live image of the camera is displayed in case of an alarm.

Instant playback

Click to determine that instant playback of the camera is displayed.

The rewind time for alarm instant playback is configured on the **Operator features** page, see *Operator Features page, page 319*.

Pause playback

Select the check box to display the alarm instant playback camera with paused instant playback. The user can start instant playback if needed.

Loop playback

Select the check box to display the alarm instant playback camera with looped instant playback.

The duration of looped instant playback in the alarm image pane is rewind time plus the duration of the alarm state plus rewind time.

Record this camera

Select the check box to enable alarm recording for this camera in case of an alarm. If an alarm is triggered, this camera is recorded in alarm recording quality. The duration of the recording is the duration of the alarm state plus pre- and post-alarm time. This setting directly changes the setting for alarm recording in the **Alarm Options** dialog box and vice versa.

Note: If a predefined position is selected for a panoramic camera, not only this image section is stored but the complete circle view.

Panoramic predefined position

If you have selected a panoramic camera, you can select a predefined camera position. When a user of the Operator Client accepts this alarm, the alarm image is displayed in the predefined position in cropped view.



If **<none>** is selected, the alarm image is displayed in panorama view.

Refer to

- *Operator Features page, page 319*
- *Configuring an alarm, page 306*

23.3**Select Image Pane Content dialog box (MG)**

Main window >

Alarms >  or  > **Alarm Options** column > Click ... > **Alarm Options** dialog box > **Monitor Group** tab > Click ... in one of the 1-10 columns

Allows you to select a camera from the Logical tree. This camera will be displayed in the assigned monitor in case of the selected alarm.

Search Item

Enter text to find an item in the Logical Tree.

Find

Click to find the camera with the entered search text in its description.

Panoramic predefined position

If you have selected a panoramic camera, you can select a predefined camera position. When a user of the Operator Client accepts this alarm, the alarm image is displayed in the predefined position in cropped view.

If you select **<none>**, the decoder displays the alarm image in circle view.

No Camera

Click to clear a camera from the monitor group column.

Note:

The field of view of a predefined panoramic camera position differs between the Operator or Configuration Client and the decoder.



Notice!

To use configured predefined positions for panoramic cameras, the **Mounting position** of the panoramic camera has to be **Wall** or **Ceiling**.

23.4

Alarm Options dialog box

Main window > **Alarms** >  or  > **Alarm Options** column > ...

Allows you to configure the following settings for alarms:

- Cameras that start recording in case of an alarm.
- Enabling protection for these alarm recordings.
- Enabling and configuring deviating alarm duration settings.
- Triggering PTZ commands in case of alarm.
- Notifications that are sent in case of an alarm.
- Workflow that has to be processed in case of an alarm.
- Assigning cameras that are displayed in monitor groups in case of an alarm.

Cameras tab

Nr	Displays the camera number as configured on the Cameras and recording page.
Name	Displays the camera name as configured on the Cameras and recording page.
Location	Displays the location as configured on the Maps and structure page.
Record	Select a check box to enable alarm recording for this camera in case of an alarm. If an alarm is triggered, this camera is recorded in alarm recording quality. The duration of the recording is the duration of the alarm state plus pre-

	and post-alarm time. This setting directly changes the setting for alarm recording in the Select Image Pane Content dialog box and vice versa.
Protect Recording	Select a check box to protect the alarm recording of this camera. Note: The protected video data will never be deleted by the VRM automatically. Be aware that too many protected blocks can fill up the storage and the camera may stop recording.
Deviating Alarm Duration Settings	The check box is automatically enabled when you enable the Record check box and when the camera supports ANR.
Auxiliary Command	Click a cell to select an auxiliary command to be executed in case of an alarm. Entries in this list are only available for a PTZ camera.
Predefined Position	Click a cell to select a predefined position to be set in case of an alarm. Entries in this list are only available for a PTZ camera.

Note: You cannot configure both, **Auxiliary Command** and **Predefined Position**, for the same camera and alarm.

Notifications tab

E-mail	Select the check box to send an e-mail in case of an alarm.
Server:	Select an e-mail server.
Recipients:	Type the e-mail addresses of the recipients separated by commas (example: name@provider.com).
Text:	Type the text of the notification.
Information:	Select the check box to add the corresponding information to the notification text. Note: For an e-mail the date of the time zone of the Management Server is used.

Workflow tab

Record only alarm	Select the check box to specify that the camera is only recorded and not being displayed in case of this alarm. This check box is only active if the Record check box on the Cameras tab is selected.
Auto-clear alarm after configured time ('Alarm Settings' dialog box)	Select the check box to specify that this alarm is automatically cleared.

Auto-clear alarm when event state changes back to normal	Select the check box to specify that this alarm is automatically cleared when the event that triggers this alarm changes its state. The alarm will not be cleared automatically if it is accepted and unaccepted.
Prevent alarm clearing while triggering state lasts	Select the check box to prevent that this alarm is deleted as long as the cause for the alarm exists.
Suppress duplicate alarms in alarm list	<p>Select the check box to avoid alarms for the same event type and device being duplicated in the Alarm List of BVMS Operator Client.</p> <p>As long as an alarm is active (in alarm state Active or Accepted), no further alarms for the same event type and device are displayed in the Alarm List.</p> <p>Note:</p> <ul style="list-style-type: none"> - Events are still logged in the logbook. - Please be aware that all alarm actions triggered by this alarm (for example starting alarm recording etc.) are not retriggered. <p>After the alarm has been cleared and a new alarm has been triggered for the same device and by the same event type, the new alarm appears again in the Alarm List and all alarm actions set for this alarm are triggered again.</p> <ul style="list-style-type: none"> - This check box is preselected for person identification alarms.
Show action plan	Select the check box to enable the workflow that must be processed in case of an alarm.
Resources...	Click to display the Resource Manager dialog box. Select a document with a description of the corresponding workflow.
Display a comment box	Select the check box to enable displaying a comment box in case of an alarm. In this comment box the user can type comments on the alarm.
Force the operator to process the workflow	Select the check box to force the user to process the workflow. If selected, the user cannot clear the alarm until he has entered a comment on the alarm.
Execute the following Client Script when alarm is accepted:	Select a Client Command Script that is executed automatically, when the user accepts an alarm.

Monitor Group tab

1...10	In a numbered column, click a cell. The Select Image Pane Content dialog box is displayed. Select a camera from the Logical Tree. This camera will be displayed in the assigned monitor in case of an alarm. Select predefined camera
---------------	--

	positions, if configured. For more information, see the Online Help for the Select Image Pane Content (MG) dialog box.
Clear Table	Click to remove all camera assignments to monitor groups.
Alarm title	Select the check box to configure that the title of the alarm is displayed on the monitors as an on-screen display.
Alarm time	Select the check box to configure that the time of the alarm is displayed on the monitors as an on-screen display.
Alarm date	Select the check box to configure that the date of the alarm is displayed on the monitors as an on-screen display.
Alarm camera name	Select the check box to configure that the name of the alarm camera is displayed on the monitors as an on-screen display
Alarm camera number	Select the check box to configure that the number of the alarm camera is displayed on the monitors as an on-screen display.
Only on 1st monitor	Select the check box to configure that the title and the time of the alarm is displayed only on the first monitor of the monitor group as an on-screen display.

Deviating Alarm Duration Settings tab

The settings on this tab are only available if ANR is enabled for this camera.

Use profile settings	Click to enable this setting. For this camera the pre-alarm and post-alarm duration settings are used that are configured in the Scheduled Recording Settings dialog box.
Override settings	Click to enable the following settings for pre-alarm and post-alarm duration.
Duration (pre-alarm)	Available for all events.
Duration (post-alarm)	Only available for  events.

Threat level tab



Elevate threat level to	Select the threat level that is triggered with this alarm. Select the Reset threat level entry if this alarm should end an active threat level. The Operator Client will then log off and the user can log in again.
--------------------------------	---

Refer to

- *Select Image Pane Content dialog box (MG), page 296*
- *Triggering alarm recording with text data, page 307*
- *Configuring an alarm, page 306*

- *Configuring the pre- and post-alarm duration for an alarm, page 307*

23.5 Select Resource dialog box

Main window > **Alarms**>  or  > **Alarm identity** column > **Audio File** column > Click ...
Allows you to select an audio file that is played in case of an alarm.

Play

Click to play the selected audio file.

Pause

Click to pause the selected audio file.

Stop

Click to stop the selected audio file.

Manage...

Click to display the **Resource Manager** dialog box.

Refer to

- *Configuring an alarm, page 306*
- *Managing resource files, page 303*

24 Configuring events and alarms

Main window > **Events**

or

Main window > **Alarms**

This chapter provides information on how to configure events and alarms in your system.

The available events are grouped beyond their corresponding devices.

In the **Events** page, you configure when an event in your BVMS triggers an alarm, executes a Command Script, and is logged.

Example (part of an Event Configuration Table):

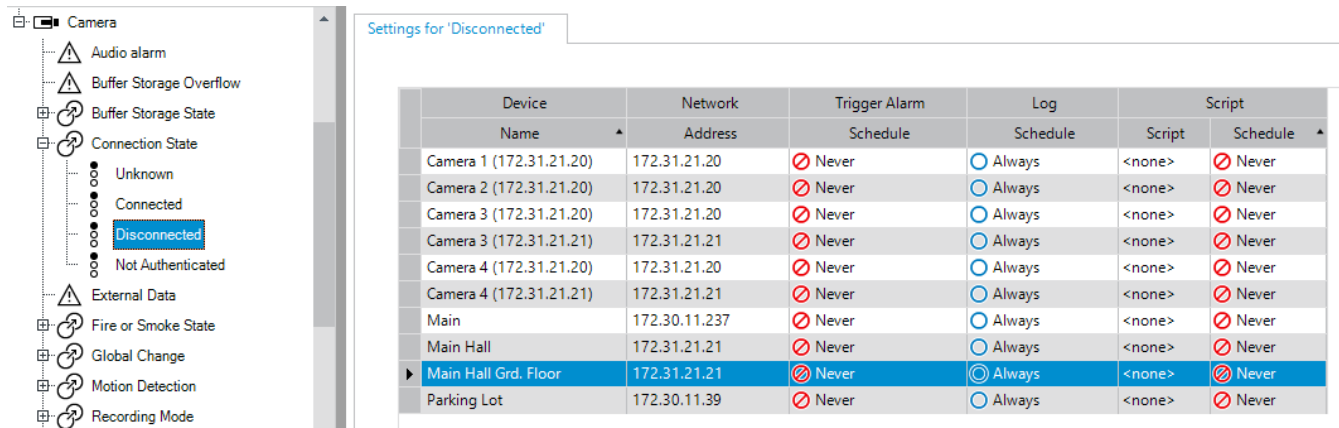



Device	Network	Trigger Alarm	Log	Script
Name	Address	Schedule	Schedule	Script
Camera 1 (172.31.21.20)	172.31.21.20	Never	Always	<none>
Camera 2 (172.31.21.20)	172.31.21.20	Never	Always	<none>
Camera 3 (172.31.21.20)	172.31.21.20	Never	Always	<none>
Camera 3 (172.31.21.21)	172.31.21.21	Never	Always	<none>
Camera 4 (172.31.21.20)	172.31.21.20	Never	Always	<none>
Camera 4 (172.31.21.21)	172.31.21.21	Never	Always	<none>
Main	172.30.11.237	Never	Always	<none>
Main Hall	172.31.21.21	Never	Always	<none>
Main Hall Grd. Floor	172.31.21.21	Never	Always	<none>
Parking Lot	172.30.11.39	Never	Always	<none>

This example means:

If the video signal of the selected camera gets lost, an alarm is triggered, the event is logged, and no script is executed.

In **Alarms**, you define how an alarm is displayed, and which cameras are displayed and recorded in case of an alarm.

Some system events are configured as alarms by default.

- Click  to save the settings.
- Click  to undo the last setting.
- Click  to activate the configuration.

Refer to

- *Debounce Settings tab, page 290*
- *Settings tab for advanced map display, page 290*
- *Settings tab for event configuration, page 291*
- *Command Script Editor dialog box, page 291*
- *Create Compound Event / Edit Compound Event dialog box, page 292*
- *Select Script Language dialog box, page 292*
- *Edit Priorities of Event Type dialog box, page 292*
- *Select Devices dialog box, page 293*
- *Text Data Recording dialog box, page 293*
- *Alarm Settings dialog box, page 295*
- *Select Image Pane Content dialog box, page 295*
- *Alarm Options dialog box, page 297*

24.1 Copying and pasting in tables

You can configure many objects simultaneously within a Camera Table, an Event Configuration Table, or an Alarm Configuration Table with a few clicks.

For detailed information, see *Copying and pasting in tables, page 276*.

24.2 Removing a table row

Main window > **Alarms**

You can only remove a table row that you or another user have added, i.e. you can delete duplicated events or Compound Events.

Compound Events are located in the Event Tree under **System Devices > Compound Events**.

To remove a table row:

1. Select the row.

2. Click  .

Refer to

– *Events page, page 289*

24.3 Managing resource files

For detailed information see:

– *Managing resource files, page 249*.

24.4 Configuring an event

Main window > **Events**

To configure an event:

1. In the tree, select an event or event state, for example **System Devices > Authentication > Operator Authentication Rejected**.

The corresponding Event Configuration Table is displayed.

2. In the **Trigger Alarm - Schedule** column, click a cell and select the appropriate schedule.

The schedule determines when the alarm is triggered.

Select one of the Recording Schedules or Task Schedules that you have configured in the **Schedules** page.

3. In the **Log - Schedule** column, click a cell and select the appropriate schedule.

The schedule determines when the event is logged.

4. In the **Script - Script** column, click a cell and select an appropriate Command Script.

5. In the **Script - Schedule** column, click a cell and select the appropriate schedule.

The schedule determines when the event triggers the start of the Command Script.

Refer to

– *Events page, page 289*

24.5 Duplicating an event

Main window > **Events**

You can duplicate an event to trigger different alarms for a particular event.

To duplicate an event:

1. In the tree, select an event condition. The corresponding Event Configuration Table is displayed.

2. Select a table row.

- Click . A new table row is added below. It has the default settings.

Refer to

- *Events page, page 289*

24.6

Logging user events

Main window > **Events** > Expand **System Devices** > **User Actions**

You can configure the logging behavior of several user actions for each available user group individually.

Example:

To log user events:

- Select a user event to configure its logging behavior, e.g. **Operator Logon**.
The corresponding Event Configuration Table is displayed.
Each user group is displayed in the **Device** column.
- If available: In the **Trigger Alarm - Schedule** column, click a cell and select the appropriate schedule.
The schedule determines when the alarm that is supposed to notify the user is triggered.
You can select one of the Recording Schedules or Task Schedules that you have configured in **Schedules**.
- In the **Log - Schedule** column, click a cell and select the appropriate schedule.
The schedule determines when the event is logged.
In the example, the Operator logon of the Admin Group and the Power User Group are not logged whereas the Operator logon of the Live User Group are logged during **Day** schedule.

Refer to

- *Events page, page 289*

24.7

Configuring user event buttons

Main window > **Events**

You can configure the user event buttons available in the Operator Client. You can configure that one or more user event buttons are not displayed in the Operator Client.

On the **User groups** page, you configure that the user event buttons are only available in the Operator Client of the corresponding user group.

To configure user event buttons:

- In the tree, select **System Devices** > **Operator Client Event Buttons** > **Event Button Pressed**.
The corresponding Event Configuration Table is displayed.
- Select a user event button to configure its behavior.
- In the **Trigger Alarm - Schedule** column, click a cell and select the appropriate schedule.
The schedule determines when the alarm that is supposed to notify the user is triggered.
- In the **Log - Schedule** column, click a cell and select the appropriate schedule.
The schedule determines when the event is logged.
Selecting **Never** makes the user event button unavailable in the Operator Client of all user groups that have the user event button permission.
- In the **Script - Script** column, click a cell and select an appropriate Command Script.
- In the **Script - Schedule** column, click a cell and select the appropriate schedule.
The schedule determines when the Command Script is executed.

Refer to
 – *Events page, page 289*

24.8 Creating a Compound Event

Main window > **Events** > 

You create a Compound Event. You can combine only state changes and their objects. Objects can be for example schedules or devices. You can combine both the state changes and their objects with the Boolean expressions AND and OR.

Example: You combine the connection states of an IP camera and a decoder. The Compound Event shall only occur when both the devices loose their connection. In this case you use the AND operator for the two objects (the IP camera and the decoder) and for the two connection states **Video Signal Lost** and **Disconnected**.

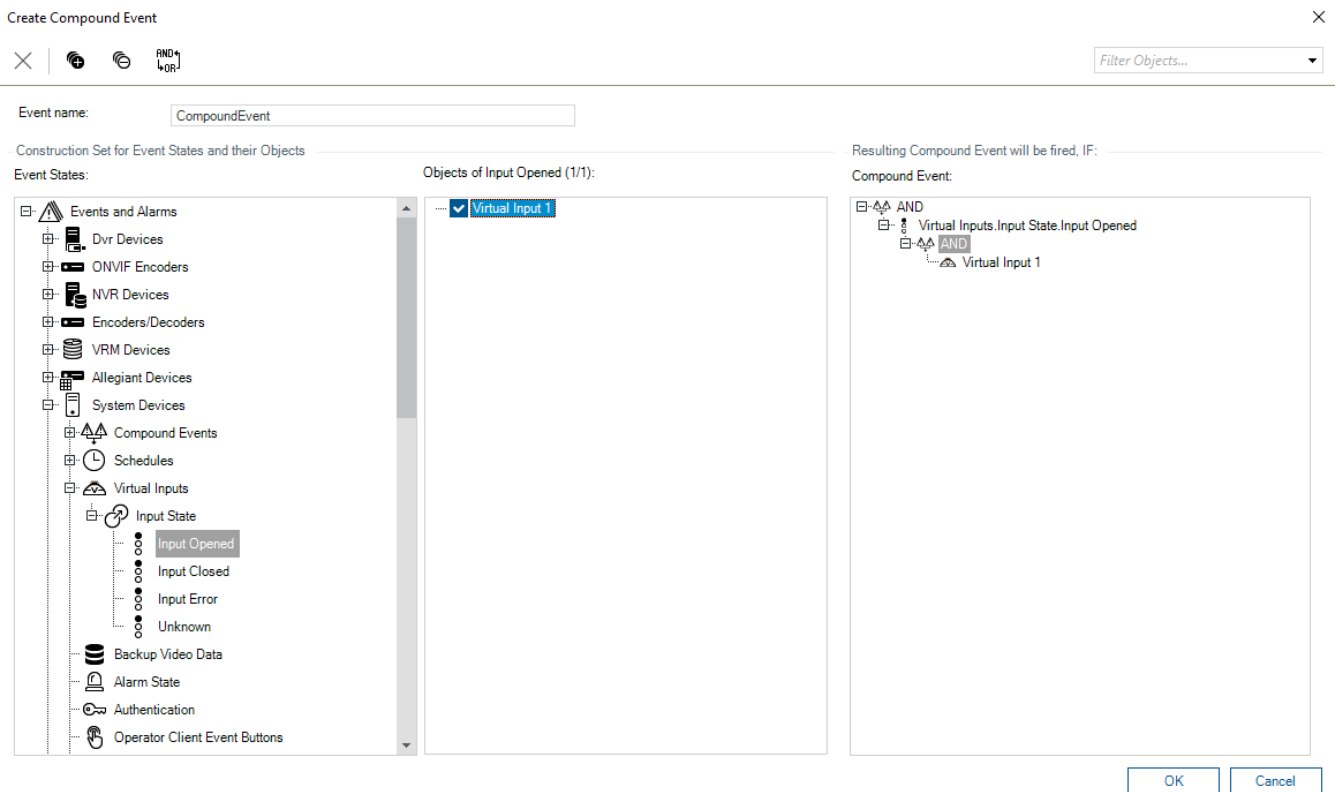

To create a Compound Event:

1. In the **Event name:** field, enter a name for the Compound Event.
2. In the **Event States:** field, select an event state.
 The available objects are displayed in the **Objects:** field.
3. In the **Objects:** field select device as required.
 The corresponding event and the selected devices are added to the Compound Event pane.
4. In the **Compound Event:** field, right-click a Boolean operation and change it where required.
 A Boolean operation defines the combination of its immediate child elements.
5. Click **OK**.
 The new Compound Event is added to the Event Configuration Table. You find it in the Event Tree below **System Devices**.

Refer to

- *Events page, page 289*

24.9 Editing a Compound Event

Main window > **Events**

You can change a previously created Compound Event.

To edit a Compound Event:

1. In the Event Tree, expand **System Devices > Compound Event State > Compound Event is True**.
2. In the Event Configuration Table, in the **Device** column, right-click the required Compound Event and click **Edit**.
The **Edit Compound Event** dialog box is displayed.
3. Make the required changes.
4. Click **OK**.
The Compound Event is changed.

Refer to

- *Events page, page 289*

24.10 Configuring an alarm

Main window > **Alarms**

Before configuring an alarm you must configure the trigger in **Events**.

To configure an alarm:

1. In the tree, select an alarm, for example **System Devices > Authentication > Operator Authentication Rejected**.
The corresponding Alarm Configuration Table is displayed.
2. In the **Priority** column, click ... in a cell to type the alarm priority for the selected alarm (100 is low priority, 1 is high priority).
In the **Title** column, click ... in a cell to type the title of the alarm to be displayed in BVMS, for example in the Alarm List.
In the **Color** column, click ... in a cell to display a dialog box for selecting a color for the alarm to be displayed in the Operator Client, for example in the Alarm List.
3. In the 1-5 columns, click ... in a cell to display the **Select Image Pane Content** dialog box. Make the required settings.
4. In the **Audio File** column, click ... in a cell to display a dialog box for selecting an audio file that is played in case of an alarm.
5. In the **Alarm Options** column, click ... in a cell to display the **Alarm Options** dialog box.
6. Make the required settings.

For detailed information on the various fields, see the Online Help for the appropriate application window.

Refer to

- *Configuring an event, page 303*
- *Alarms page, page 294*
- *Select Image Pane Content dialog box, page 295*
- *Alarm Options dialog box, page 297*

24.11 Configuring settings for all alarms

Main window > **Alarms**

You can set the following alarm settings that are valid for this Management Server:

- Number of Image panes per alarm
- Auto-clear time
- Manual alarm recording time
- Multi-row alarm display in alarm image window
- Duration limit for state-triggered alarm recordings
- Configure the behavior of all monitor groups

To configure all alarms:

1. Click . The **Alarm Settings** dialog box is displayed.
2. Make the appropriate settings.
 - ▶ Click **OK**.

For detailed information on the various fields, see the Online Help for the appropriate application window.

Refer to

- *Alarm Settings dialog box, page 295*

24.12

Configuring the pre- and post-alarm duration for an alarm

For configuring pre-alarm and post-alarm duration settings you need a camera that supports ANR and firmware 5.90 or later must be installed.



Main window > **Cameras and recording** > 

- ▶ For the desired camera, click to enable **ANR**.

Main window > **Events**

- ▶ Configure the desired event for the ANR activated camera.

Main window > **Alarms**

1. Configure an alarm for this event.
2. Select  or .
3. In the **Alarm Options** column click ... The **Alarm Options** dialog box is displayed.
4. In the **Record** column, select the check box of the ANR enabled camera to enable alarm recording. The check box in the **Deviating Alarm Duration Settings** column is selected automatically.
5. Click the **Deviating Alarm Duration Settings** tab.
6. Configure the alarm duration settings as required.

Refer to

- *Alarm Options dialog box, page 297*

24.13

Triggering alarm recording with text data

Main window > **Alarms**

You can trigger alarm recording with text data.

Before configuring an alarm you must configure an event that contains text data.

Example: **Events** > In the Event Tree select  (text data must be available, for example: **Foyer Card Reader Devices** > **Foyer Card Reader** > **Card Rejected**)

**Notice!**

Configure the debounce time for the selected event to 0.
This ensures that no text data is lost.

To configure alarm recording:

1. In the tree, select an alarm, for example **ATM/POS Devices** > **ATM Input** > **Data Input**.
The corresponding Alarm Configuration Table is displayed.
2. Make the required settings.
3. In the **Alarm Options** column, click ... in a cell to display the **Alarm Options** dialog box.
4. Click the **Cameras** tab and click to select the **Record** checkbox.

Refer to

- *Alarm Options dialog box, page 297*
- *Text Data Recording dialog box, page 293*

24.14**Adding text data to continuous recording**

Main window > **Events** > In the Event Tree select  **Data Input** (text data must be available, for example: **Foyer Card Reader Devices** > **Foyer Card Reader** > **Card Rejected**) > **Text Data Recording** column > ...

You can add text data to continuous recording.

24.15**Protecting alarm recording**

Main window > **Alarms**

Before configuring an alarm you must configure an event in **Events**.

**Notice!**

If you protect the alarm recording of a camera, the protected video data will never be deleted by the VRM automatically. Be aware that too many protected blocks can fill up the storage and the camera may stop recording. You have to manually unprotect the video data in the Operator Client.

To configure alarm recording:

1. In the tree, select an alarm, for example **ATM/POS Devices** > **ATM Input** > **Data Input**.
The corresponding Alarm Configuration Table is displayed.
2. Make the required settings.
3. In the **Alarm Options** column, click ... in a cell to display the **Alarm Options** dialog box.
4. Click the **Cameras** tab and click to select the **Record** checkbox.
1. Select the **Protect Recording** checkbox.

Refer to

- *Alarm Options dialog box, page 297*

24.16 Configuring blinking hotspots



Notice!

A blinking hotspot can only be configured for an event OR an alarm.

Main window > **Events**

or

Main window > **Alarms**

For each  event or alarm, you can configure the background color and the behavior

(blinking or not blinking) for hotspots. For example you can configure for a  event or alarm of a device that its device icon on a map starts blinking when the state of this device changes.

Additionally you can configure the display priority for all hotspots. This is required when different events occur for the same device. (1 = highest priority)

The configured color is valid for all hotspots with the same display priority. You can change

color, behavior and priority at any  event or alarm: The changed color and behavior is

used for all hotspots of all other  events or alarms which have the same priority.

The configuration of the color states on maps is only possible when you click to check the **Enabled advanced state display (hot spot coloring in maps depending on state)** option or the **Enabled advanced state display (hot spot coloring in maps depending on alarm)** option in the **Options** dialog box.

To configure a blinking hotspot for an event:

1. In the tree, select an event state (), for example **Encoders/Decoders > Encoder Relay > Relay State > Relay Opened**.
The corresponding Event Configuration Table is displayed.
2. Click **Enable color states on maps**.
3. In the **Display priority on map:** field, enter the desired priority.
4. Click the **Background color on map:** field to select the desired color.
5. If desired, click to enable **Blinking**.

To configure a blinking hotspot for an alarm:

See chapter *Alarm identity*, page 294 on the *Alarms* page, page 294.



Notice!

Only if the alarm is on the alarm list, the hotspot blinks.

The device icons on a map blink in the same color configured for the alarm or event.

Refer to

- *Events page*, page 289
- *Options dialog box (Settings menu)*, page 119

24.17 Events and alarms for access control systems

Additional information about events and alarms for access control systems.

Access requested event

The event allows a BVMS operator to manually grant or deny access to a person via an access control system. You can configure alarm recording, text data recording or additional information to this event.

Access requested events are only sent to BVMS, if the option **Additional verification** is set on each reader of the access control system. In the BVMS event configuration the **Access requested** events sent by the readers always trigger an alarm in BVMS.



Notice!

We recommend to set the highest priority (1) for the **Access requested** alarms. This ensures that the alarms automatically pop-up and receive the necessary attention of the operator.

24.18 Events and alarms for Person Identification

Main window > **Events**

Additional information about events and alarms for Person Identification.

Unauthorized person detected

For each camera you can configure which person group is authorized or unauthorized to access a certain area.

Note: The configuration of unauthorized and authorized person groups is only possible if you have the **Change Event Settings** permission.

To configure Unauthorized person detected

1. Select the respective camera under **Video Analytics**.
2. Select the **Unauthorized person detected** event.
3. Select the **Unauthorized person detected** tab.
4. Click ... in the **Unauthorized** or the **Authorized** cell.

The **Authorization for camera** dialog box displays.

5. By drag and drop set the configured person groups to the respective field.
6. Click **OK**.

For the respective camera, the configured person groups are now set as authorized or unauthorized.

25 User Groups page



Notice!

BVMS Viewer offers only basic features. Advanced features are included in BVMS Professional. For detailed information about the different BVMS editions refer to www.boschsecurity.com and the BVMS Quick Selection Guide: [BVMS Quick Selection Guide](#).

Main window > **User groups**

Allows you to configure user groups, Enterprise User Groups and Enterprise Access.

The following user group is available by default:

- Admin Group (with one Admin user).

User groups tab

Click to display the pages available for configuring the rights of the standard user group.

Enterprise User Groups tab

Click to display the pages available for configuring the permissions of an Enterprise User Group.

Enterprise Access tab

Click to display the pages available for adding and configuring Enterprise Access.

User/user group options

Icon	Description
	Click to delete a selected entry.
	Click to add a new group or account.
	Click to add a new user to the selected user group. Change the default user name if desired.
	Click to add a new dual authorization group.
	Click to add a new logon pair for dual authorization.
	Displays a dialog box for copying permissions from a selected user group to another user group.
	Click to display the pages available for configuring the permissions of this group.
	Click to display the page available for configuring the properties of this user.
	Click to display the page available for configuring the properties of this logon pair.
	Click to display the pages available for configuring the permissions of this dual authorization group.

Activating user name changes and password changes



Click to activate password changes.



Click to activate user name changes.



Notice!

User name changes and password changes are reverted after a configuration rollback.

Permissions on an Enterprise System

For an Enterprise System you configure the following permissions:

- Operating permissions of Operator Client defining the user interface for operating in the Enterprise System, for example the user interface of the alarm monitor.
Use an Enterprise User Group. Configure it on the Enterprise Management Server.
- Device permissions that should be available for operating in an Enterprise Management Server are defined on each Management Server.
Use Enterprise Accounts. Configure it on each Management Server.

Permissions on a single Management Server

For managing the access to one of the Management Servers, use the standard user group. You configure all permissions on this Management Server in this user group.

You can configure dual authorization user groups for standard user groups and for Enterprise User Groups.

Type	Contains	Available configuration settings	Where do you configure?
User group	Users	- Operating and device permissions	- Management Server
Enterprise User Group	Users	- Operating permissions - Per Management Server: Name of the corresponding Enterprise Access Accounts with logon credentials	- Enterprise Management Server
Enterprise Account	-	- Device permissions - Account key	- Management Server
Dual authorization user group	User groups	- See user groups	- See user groups
Enterprise dual authorization	Enterprise User Groups	- See Enterprise User Groups	- See Enterprise User Groups

To search for items:

- ▶ In the search field type a string and press the ENTER key to filter the displayed items.
Only items containing the string and their corresponding parent items (only in trees) are displayed. The count of filtered items and the total count of items is provided.

Note: Enclose strings with double quotes to find them exactly, for example "Camera 1" exactly filters the cameras with this name, not camera 201.

25.1 User Group Properties page

Main window > **User groups** > **User groups** tab >  > **Operating permissions** tab > **User group properties** tab
or

Main window > **User groups** > **Enterprise User Groups** tab >  > **Operating permissions** tab > **User group properties** tab

Allows you to configure the following settings for the selected user group:

- Logon schedule
- Selection of an associated LDAP user group

User group properties

Description:

Type an informative description for the user group.

Language

Select the language of the Operator Client.

Logon schedule

Select a task or recording schedule. The users of the selected group can only log on to the system in the times defined by this schedule.

LDAP properties

Search for groups

Click to display the available associated LDAP groups in the **Associated LDAP group** list. To select an associated LDAP group, you must make the appropriate settings in the **LDAP server settings** dialog box.

Associated LDAP group

Select an LDAP group in the **Associated LDAP group** list that you want to use for your system.

Refer to

- *Selecting an associated LDAP group, page 337*
- *Associating an LDAP group, page 117*
- *Scheduling user logon permission, page 338*

25.2 User Properties page

Main window > **User groups** > **User groups** tab >  > 
or

Main window > **User groups** > **Enterprise User Groups** tab >  > 

Allows you to configure a new user in a standard user group or in an Enterprise User Group. If you change the password for a user or delete a user while this user is logged on, this user can still continue working with Operator Client after password change or deletion. If after password change or deletion the connection to Management Server is interrupted (for example after activating the configuration), the user cannot automatically reconnect to the Management Server again without logoff/logon at Operator Client.

Account is enabled

Select check box to activate a user account.

Full name

Type the full name of the user.

Description

Type an informative description for the user.

User must change password at next logon

Select check box to enforce users to set a new password at next logon.

Enter new password

Type the password for the new user.

Confirm password

Type the new password again.



Notice!

To activate the changes in this dialog, click



Notice!

We highly recommend to assign a specific password to all new users, and have the user change this at logon.



Notice!

Clients of Mobile Video Service, Web Client, Bosch iOS App and SDK clients are not able to change the password on logon.

Apply

Click to apply the settings.

Click  to activate the password.



Additional information

After upgrading to BVMS 9.0.0.x the **User Properties** settings are the following:

- **Account is enabled** is set.
- **User must change password at next logon** is not set.

25.3

Logon Pair Properties page

Main window > **User groups** > **User groups** tab >  **New dual authorization group** > 

Main window > **User groups** > **Enterprise User Groups** tab >  **New enterprise dual authorization group** > 

Allows you to modify a pair of user groups to a dual authorization group. The users of the first user group are the users that must log on in the first dialog box for logging on, the users of the second user group confirm the logon.

Select Logon Pair

In each list, select a user group.

Force dual authorization

Select the check box to force each user to log on only together with a user of the second user group.

Refer to

– *Adding a logon pair to dual authorization group, page 336*

25.4**Camera Permissions page**

Main window > **User groups** > **User groups** tab >  > **Device permissions** tab > **Camera permissions** tab

or

Main window > **User groups** > **Enterprise Access** tab >  > **Device permissions** tab > **Camera permissions** tab

Allows you to configure the access rights for the features of a selected camera or camera group for the selected user group.

If new components are added, camera permissions must be configured afterwards.

You can recall the access to a camera on the **Camera** page.

Camera

Displays the camera name as configured on the **Cameras and recording** page.

Location

Displays the location of the camera as configured on the **Maps and structure** page.

Access

Select a check box to allow access to this camera.

Live Video

Select a check box to allow using live video.

Live Audio

Select a check box to allow using live audio.

Manual Recording

Select a check box to allow manual recording (alarm recording).

You can select or clear this check box only when the manual alarm recording is enabled on the **Operator features** page.

Playback Video

Select a check box to allow using playback video.

You can select or clear this check box only when playback is enabled on the **Operator features** page.

Playback Audio

Select a check box to allow using playback audio.

You can select or clear this check box only when playback is enabled on the **Operator features** page.

Text Data

Select a check box to allow displaying metadata.

You can select or clear this check box only when the display of metadata is enabled on the **Operator features** page.

Export

Select a check box to allow exporting video data.

You can select or clear this check box only when the export of video data is enabled on the **Operator features** page.

PTZ/ROI

Select a check box to allow using the PTZ control or the ROI of this camera.

You can select or clear this check box only when the PTZ control or ROI of this camera is enabled on the **Operator features** page. Additionally you must configure PTZ or ROI in the Camera Table.

Aux

Select a check box to allow executing auxiliary commands.

You can select or clear this check box only when the PTZ control of a camera is enabled on the **Operator features** page.

Set predefined positions

Select a check box to allow the user to set prepositions of this PTZ camera.

You can also set prepositions for the Region of Interest feature, if enabled and authorized.

You can select or clear this check box only when the PTZ control of a camera is enabled on the **Operator features** page.

Reference Image

Select a check box to allow updating the reference image of this camera.

Privacy overlay

Select a check box to enable Privacy overlay for this camera in live and playback mode.

25.5

Control Priorities page

Main window > **User groups** > **User groups** tab >  > **Device permissions** tab > **Control priorities** tab
or

Main window > **User groups** > **Enterprise Access** tab >  > **Device permissions** tab > **Control priorities** tab

Control priorities

Move the appropriate slider to the right to decrease the priority for acquiring PTZ controls and Bosch Allegiant trunk lines. A user with a high priority can lock the PTZ controls or the control of a trunk line for users with lower priorities. You set the timeout for locking PTZ control on the **Timeout in min.** field. The default setting is 1 minute.

Timeout in min.

Enter the time period in minutes.

Refer to



– *Configuring various priorities, page 339*

25.6

Copy User Group Permissions dialog box

Main window > **User groups** > **User groups** tab >  > 

or

Main window > **User groups** > **Enterprise User Groups** tab >  > 
 Allows you to select user group permissions to be copied to selected user groups.

Copy from:

Displays the selected user group. Its permissions are to be copied to another user group.

Settings to copy

Select a check box to select the desired user group permissions for copying.

Copy to:

Select a check box to specify the user group where to copy the selected user group permissions to.

Refer to

– *Copying user group permissions, page 339*

25.7

Decoder Permissions page

Main window > **User groups** > **User groups** tab >  > **Device permissions** tab > **Decoder permissions** tab
 or

Main window > **User groups** > **Enterprise Access** tab >  > **Device permissions** tab > **Decoder permissions** tab
 Allows you to configure the decoders that the users of this group have access to.

Decoder

Displays the available decoders.

Click the check box to give the user group access to this decoder.

Monitor Group

Select the check box to give the users of the selected user group access to this monitor group.

25.8

Events and Alarms page

Main window > **User groups** > **User groups** tab >  > **Device permissions** tab > **Events and alarms** tab
 or

Main window > **User groups** > **Enterprise Access** tab >  > **Device permissions** tab > **Events and alarms** tab

Allows to configure the permissions for the Events Tree, for example you set the events the user group is authorized or not authorized to use.

You cannot change these settings for a default user group.

For each event there is at least one device. For example, for the **Video Loss** event the available cameras are the devices. For an event like **Backup Finished** the corresponding device is **Time Controlled Backup**. Hence, a device can be a software process.

1. Expand a tree item and click the required check boxes for enabling the events. In the **Access** column, select the check box of a device to enable the events of this device. The access to the devices is configured on the **Camera** page and on the **Camera permissions** page.
2. To enable or disable all events at once, select or clear the **Events and alarms** check box.

25.9 Credentials page

Main window > **User groups** > **Enterprise Access** tab >  > **Device permissions** tab > **Credentials** tab

Configure the credentials of an Enterprise Account on a Management Server.

You configure Enterprise Access on each Management Server that is member of your Enterprise System. The Enterprise Management Server uses this credential to grant access to the devices of this Management Server for the Operator Client that logs on as a user of an Enterprise User Group.

Description:

Type in a description for the desired Enterprise Account.

Strong key policy

The **Strong key policy** check box is pre-selected for all newly created user groups.

We highly recommend to keep this setting to enhance the protection of your computer against unauthorized access.

The following rules apply:

- Minimum key length as set on the **Account policies** page for the appropriate user group.
- Do not use one of the previous keys.
- Use at least one upper-case letter (A through Z).
- Use at least one number (0 through 9).
- Use at least one special character (for instance: ! \$ # %).

Enter new key: / Confirm key:

Type in and confirm the key for this Management Server.

Refer to

- *Creating an Enterprise Account, page 334*

25.10 Logical Tree page

Main window > **User groups** > **User groups** tab >  > **Device permissions** tab > **Logical tree** tab

or

Main window > **User groups** > **Enterprise Access** tab >  > **Device permissions** tab > **Logical tree** tab

Allows you to configure the Logical Tree for each user group.

To configure permissions:

- ▶ Select or clear the check boxes as appropriate.
 - Selecting an item below a node, automatically selects the node.
 - Selecting a node, automatically selects all items below.

Camera

Select a check box to give the users of the selected user group access to the corresponding devices.

You can recall the access to a camera on the **Camera permissions** page.

Monitor Group

Select the check box to give the users of the selected user group access to this monitor group.

Refer to

– *Configuring device permissions, page 338*

25.11 Operator Features page

Main window > **User groups** > **User groups** tab >  > **Operating permissions** tab > **Operator features** tab
or

Main window > **User groups** > **Enterprise User Groups** tab >  > **Operating permissions** tab > **Operator features** tab

Allows you to configure various permissions for the selected user group.

PTZ control of dome cameras

Select the check box to allow the control of a camera.

Control priorities page: In the **Control priorities** field, you can set the priority for acquiring the control of a camera.

Allegiant trunk lines

Select the check box to allow accessing Bosch Allegiant trunk lines.

Control priorities page: In the **Control priorities** field, you can set the priority for acquiring Bosch Allegiant trunk lines.

Print and save

Select the check box to allow printing and saving video, maps and documents.

Alarm processing

Select the check box to allow alarm processing.

Interrupt the windows screen saver for incoming alarms

Select the check box to ensure that an incoming alarm is displayed even when the screen saver is active. If the screen saver requires a user name and password for being interrupted, this setting has no effect.

Alarm display

Select the check box to allow alarm display. If you select this option, the **Alarm processing** is deactivated simultaneously.

Playback

Select the check box to allow various playback features.

Export video

Select the check box to allow exporting video data.

Export to non-native formats

Select the check box to allow exporting video data to non-native format.

Protect video

Select the check box to allow protecting video data.

Unprotect video

Select the check box to allow both protecting and unprotecting video data.

Restrict video (restricted video can only be viewed by users that have this permission)

Select the check box to allow restricting video data.

Unrestrict video

Select the check box to allow both, restricting and unrestricting video data.

**Notice!**

VRM

Configure the user permissions for restricting and unrestricting video data in BVMS as required.

Only a user, that has the **Restrict video (restricted video can only be viewed by users that have this permission)** permission, can see restricted video in the timeline of the Operator Client. The restricted time range is otherwise displayed as **No Recording**.

**Notice!**

DIVAR AN

Configure the user permissions for restricting and unrestricting video data on your DIVAR AN device as required. Create a user in BVMS with the same credentials and configure the permissions for restricting and unrestricting video data accordingly.

Display of restricted video is not affected and must be configured separately on the DIVAR AN device.

Delete video

Select the check box to allow deleting video data.

Access to video that has been recorded in periods when the user group has not been allowed to log on

Select the check box to allow accessing the described video data.

Logbook access

Select the check box to allow accessing the Logbook.

Erase text data from logbook entries (for erasing person-related data)

Select the check box to allow erasing text data from logbook entries.

Operator event buttons

Select the check box to allow user event buttons in the Operator Client.

Close Operator Client

Select the check box to allow closing the Operator Client.

Minimize Operator Client

Select the check box to allow minimizing the Operator Client.

Audio Intercom

Select the check box to allow the user to speak on the loudspeakers of an encoder with audio-in and audio-out function.

Manual alarm recording

Select the check box to allow manual alarm recording.

Access VRM monitor

Select the check box to allow access to the VRM Monitor software.

Set reference image

Select the check box to allow updating the reference image in the Operator Client.

Set area selection for reference image

Select the check box to allow selecting the area in the camera image for updating the reference image in the Operator Client.

Change password

Select the check box to allow a user of Operator Client to change the password for logging on.

Arm intrusion panel areas

Select the check box to allow a user of Operator Client to arm areas configured in an intrusion panel that is part of your BVMS configuration.

Force arm intrusion panel areas

Select the check box to allow a user of Operator Client to force the arming of areas configured in an intrusion panel that is part of your BVMS configuration.

Disarm intrusion panel areas

Select the check box to allow a user of Operator Client to disarm areas configured in an intrusion panel that is part of your BVMS configuration.

Silence bells for intrusion panel areas

Select the check box to allow a user of Operator Client to switch off alarm sirens of areas configured in an intrusion panel that is part of your BVMS configuration.

Bypass intrusion panel points

Select the check box to allow a user of Operator Client to change the state of a point configured in an intrusion panel to the **Point bypassed** state. A bypassed point cannot send an alarm. When the state is changed back to **Point unbypassed**, a pending alarm is sent if available

Unlock intrusion panel doors

Select the check box to allow a user of Operator Client to unlock a door configured in an intrusion panel.

Secure and unsecure intrusion panel doors

Select the check box to allow a user of Operator Client to secure and unsecure a door configured in an intrusion panel.

Cycle intrusion panel doors

Select the check box to allow a user of Operator Client to cycle a door configured in an intrusion panel.

Operate access doors

Select the check box to allow a user of Operator Client to change the access door state (secure, lock, unlock).

Person management

Select the check box to allow a user of Operator Client to manage persons for person identification alarms.

Display order in case of same alarm priority

Select the appropriate value to configure the order of Alarm Image panes in the Alarm Display of Operator Client.

Instant playback rewind time:

Enter the number of seconds for the duration of alarm instant playback.

Repeat alarm audio:

Select the check box and enter the number of seconds after an alarm sound is repeated.

Limit access to recorded video to the last n minutes:

Select the check box to limit the access to recorded videos.

In the list, enter the number of minutes.

Enforce automatic Operator logoff after this time of inactivity:

Select the check box to enable the automatic logoff of Operator Client after the configured time period.

Refer to

– *Inactivity logoff, page 43*

25.12

Priorities page

Main window > **User groups** > **User groups** tab >  > **Operating permissions** tab > **Priorities** tab
or

Main window > **User groups** > **Enterprise User Groups** tab >  > **Operating permissions** tab > **Priorities** tab

Allows you to configure the timeout for explicit PTZ locking. You can set the priorities for PTZ control and the display of incoming alarms.

Automatic popup behavior

Move the slider to adjust the priority value of Live Image window or Playback Image window. This value is required for incoming alarms to decide whether this alarm is automatically displayed in the Alarm Image window.

For example: If you move the slider for Live Image window to 50 and for the Playback Display to 70 and an alarm comes in with a priority of 60, the alarm is only automatically displayed if the user has Playback Display active. The alarm is not automatically displayed when the user has Live Display active.

Refer to

– *Configuring various priorities, page 339*

25.13

User Interface page

Main window > **User groups** > **User groups** tab >  > **Operating permissions** tab > **User interface** tab
or

Main window > **User groups** > **Enterprise User Groups** tab >  > **Operating permissions** tab > **User interface** tab

Allows you to configure the user interface of 4 monitors used by Operator Client. You can configure a multi monitor mode with up to 4 monitors. You set for every monitor what is displayed on it, e.g. monitor 2 only displays Live Image panes or Monitor 1 and Monitor 2 use the 16:9 aspect ratio for HD cameras.

Control Monitor

Select the monitor which should be used as a control monitor.

Max. rows of image panes in playback

Select the maximum rows of Image panes displayed in the Playback Image window on the Control monitor.

Alarm Monitor

Select the alarm monitor which can display either live and alarm content or only alarm content.

Monitor 1 - 4

In the corresponding list of each monitor, select the required entry.

- For the Control monitor the entry **Control** is preselected and cannot be changed.
- For the Alarm monitor you can select one of the following entries:
 - **Live video and alarm content**
 - **Alarm content only**
- For the remaining monitors you can select one of the following entries:
 - **Live video only**
 - **Map and document**
 - **Two maps and document**
 - **Fullscreen live video**
 - **Quad live image**

Max. rows of image panes

Select the maximum rows of Image panes displayed in the Image window on the appropriate monitor.

Note: This option is only available for the following views:

- **Control**
- **Alarm content only**
- **Live video and alarm content**
- **Live video only**

The remaining views have a fixed layout with a fixed number of Image pane rows and cannot be changed.

Image panes aspect ratio

For each monitor select the required aspect ratio for the initial startup of Operator Client. Use 16:9 for HD cameras.

Restore Default

Click to restore the default settings of this page. All list entries are reset to their default settings.

25.14 Server Access page

Main window > **User groups** > **Enterprise User Groups** tab >  > **Server access** tab

You configure the server access on an Enterprise Management Server.

You enter the name of the Enterprise Account and its password for each Management Server of your Enterprise System. This account is configured on each Management Server.

Management Server

Displays the name of the Management Server that you configured on this Enterprise Management Server.

Network address

Displays the private IP address or DNS name of the Management Server.

Server Number

Displays the number of the Management Server. This number is used by a Bosch IntuiKey keyboard to select the desired Management Server.

Access

Select the checkbox when you want to grant access to the Management Server. This Management Server is now an Enterprise Management Server.

Enterprise Account

Type the name of the Enterprise Account that has been configured on the Management Server.

Authentication

Select the respective authentication option in the **Authentication settings** dialog.

Config API

Select the checkbox if the access token should allow access to the Config API service of the Management Server.

Server Description

Displays the descriptive text for this server.

Further columns are displayed if they have been added to the Server List.

Refer to

- *Creating a group or account, page 333*
- *Creating an Enterprise System, page 86*
- *Configuring the Server List for Enterprise System, page 86*
- *Token-based authentication, page 88*

25.15**Configuration Permissions page****Notice!**

This document describes some functions that are not available for BVMS Viewer.

For detailed information about the different BVMS editions refer to www.boschsecurity.com and the BVMS Quick Selection Guide: [BVMS Quick Selection Guide](#).

Main window > **User groups** > **User groups** tab >  > **Operating permissions** tab > **Configuration permissions** tab

or

Main window > **User groups** > **Enterprise User Groups** tab >  > **Operating permissions** tab > **Configuration permissions** tab

Allows you to configure various user permissions for the Configuration Client.

Permission to start the Configuration Client implies read-only access.

Device Tree

In this section you can specify the permissions on the **Devices** page. Select the check box for the respective permission.

Maps and structure

In this section you can specify the permissions on the **Maps and structure** page. Select the check box of the respective permission.

Schedules

In this section you can specify the permissions on the **Schedules** page. Select the check box of the respective permission.

Cameras and recording

In this section you can specify the permissions on the **Cameras and recording** page. Select the check box of the respective permission.

Events

In this section you can specify the permissions on the **Events** page. Select the check box of the respective permission.

Alarms

In this section you can specify the permissions on the **Alarms** page. Select the check box of the respective permission.

User groups

In this section you can specify the permissions for configuring user groups. Select the check box of the respective permission.

**Notice!**

To select the **Configure User Groups/Enterprise Accounts** check box and the **Configure Users** check box are mutually exclusive options for security reasons.

Menu commands

In this section you can specify the permissions for configuring menu commands. Select the check box of the respective permission.

Reports

In this section you can specify the permissions for configuring reports. Select the check box of the respective permission.

**Notice!**

If you want to use the Config API service of the Management Server, you have to select the following **Configuration permissions**:

- **Change device properties**
- **Call Activation Manager**

**Notice!**

If you want to configure the **Trusted certificate settings**, you have to select the **Configure User Groups/Enterprise Accounts** permission.

25.16**User Group Permissions page**

Main window > **User groups** > **User groups** tab >  > **Operating permissions** tab > **User group permissions** tab

or

Main window > **User groups** > **Enterprise User Groups** tab >  > **Operating permissions** tab > **User group permissions** tab

Allows you to assign in which user groups the users of a specific user group can add new users.

**Notice!**

You can only assign user group permissions to a user group, to which you have assigned the permission to configure users before. You assign this permission on the **Configuration permissions** page.

**Notice!**

The users of a standard user group are not allowed to add new users to the Admin Group. This check box is not active.

Refer to

– *Configuration Permissions page, page 324*

25.17**Account policies page**

Main window > **User groups** > **User groups** tab >  > **Security** tab > **Account policies** tab
or

Main window > **User groups** > **Enterprise User Groups** tab >  > **Security** tab > **Account policies** tab

Allows you to configure settings for users and passwords.

Strong password policy

Select the check box to enable the password policy.

For more information see: *Configuring users, permissions and Enterprise Access, page 332*

**Notice!**

The **Strong password policy** setting is only applied to the users if the check box is selected in the corresponding user group.

We highly recommend to keep this setting to enhance the protection of your computer against unauthorized access.

Minimum password length

This setting determines the least number of characters that can make up a password for a user account.

Select the check box to enable the setting and enter the minimum number of characters.

Maximum password age in days

This setting determines the period of time (in days) that a password can be used before the system requires the user to change it.

Select the check box to enable the setting and enter the maximum number of days.

Number of used passwords in history

This setting determines the number of unique new passwords that must be associated with a user account before an old password can be reused.

Select the check box to enable the setting and enter the minimum number of passwords.

Maximum invalid logon attempts

This setting determines the disabling of an account after a specific number of invalid logon attempts.

Select the check box to enable the setting and enter the maximum number of attempts.

If the **Maximum invalid logon attempts** check box is selected, you can specify the following two settings:

Account lockout duration

This setting determines the number of minutes that a disabled account remains disabled before automatically becoming enabled.

Select the check box to enable the setting and enter the number of minutes.

Reset account lockout counter after

This setting determines the number of minutes that must elapse from the time a user fails to log on before the failed logon attempt counter is reset to zero.

Select the check box to enable the setting and enter the number of minutes.

**Notice!**

If the maximum number of invalid logon attempts exceeds, the account is disabled.

If the **Account lockout duration** check box is not selected, the account has to be enabled manually.

If the **Account lockout duration** check box is selected, the account automatically becomes enabled after the defined time period.

**Notice!**

The counter of invalid logon attempts resets to zero:

After a successful login.

Or after the specified duration, if the **Reset account lockout counter after** check box is selected.

Disable offline client

Select the check box to disable logon to an offline client.

Additional information

From BVMS 9.0 on the following **Account policies** settings apply as default:

- The **Strong password policy** check box is pre-selected.
- The **Minimum password length** check box is pre-selected. The default value is 10.
- The **Maximum password age in days** check box is not pre-selected. The default value is 90.
- The **Number of used passwords in history** check box is not pre-selected. The default value is 10.
- The **Maximum invalid logon attempts** check box is not pre-selected. The default value is 1.
- The **Disable offline client** check box is not pre-selected.

From BVMS 10.0.1 on the following **Account policies** settings are selected by default for all user groups:

- **Maximum invalid logon attempts**
- **Account lockout duration**
- **Reset account lockout counter after**

25.17.1**Offline Operator Client**

With the feature of the Offline Operator Client the following use cases are possible:

- Operator Client continues operation for Live, Playback and Export without connection to the Management Server computer.
- If a workstation was connected once to the Management Server computer, it can log on offline any time with any user.

For Offline Mode BVMS must have version 3.0 or later.

If an Operator Client workstation is disconnected from the Management Server computer, it is possible to continue working. Some main functions are still available, for example live and playback video.

As of BVMS V5.5 an Operator Client workstation can work offline with a configuration of BVMS V5.0.5.

**Notice!**

When a password change on the Management Server occurs during the period when Operator Client is offline, this password change is not propagated to this Operator Client. When Operator Client is online, the user must log on using the new password. When Operator Client is offline, the user must again use the old password for logon. This is not changed until a new configuration is activated and transferred to the Operator Client workstation.

**Notice!**

When a camera is called up for display in a monitor group with a workstation connected Bosch Intuitykey keyboard, and the workstation is offline, the keyboard does not send an error tone.

25.17.1.1**Working with Offline Mode**

When Operator Client is disconnected from a Management Server, the respective overlay icon



is displayed in the Logical Tree on the disconnected Management Server. You can continue working with Operator Client even if the disconnection lasts longer, but some functions are not available.

If the connection to the Management Server is reestablished, a respective overlay icon is displayed.

If a new configuration on a Management Server has been activated, a respective icon is displayed in the Logical Tree on the icon of the affected Management Server and a dialog box is displayed for some seconds. Accept or refuse the new configuration.

If your Operator Client instance is scheduled to log off at a specific point in time, this logoff occurs even when the connection to the Management Server is not reestablished at this point in time.

When a user of Operator Client logs on using Server Lookup in offline state, the Server List of the last successful logon is displayed. Offline state here means that the Operator Client workstation does not have a network connection to the server containing the Server List.

Functions not available during disconnection

When disconnected from Management Server the following functions are not available in Operator Client:

- Alarm List:
This includes handling alarms. The alarm list is empty and will automatically be filled on reconnection.
- Allegiant:
The trunk line handling is not available. In earlier versions, Allegiant cameras were automatically closed with a message-box when a trunk line handling was unavailable. With BVMS V3.0 we will show a more user friendly Image pane informing the user about the impossibility to display this camera right now.
- MG:
It is not possible to drag cameras on the MG control. The control is disabled and will automatically be enabled on reconnection.
- PTZ priorities:

Without a connection to Management Server , an offline Operator Client can connect a PTZ camera as long as the PTZ camera itself is not locked. The dome priorities will automatically be updated on reconnection.

- Input:
Input cannot be switched.
- Logbook:
The Logbook is not available and cannot be opened. An opened Logbook search window is not closed automatically. Existing search results can be used and exported.
- Operator Client SDK:
Operator Client SDK functions with IServerApi cannot be processed.
Creating a RemoteClientApi is not possible.
Some methods that are only available at client API do not work, for example ApplicationManager (try GetUserName()).
- Password change:
The operator is not able to change his password.
- Relay:
Relays cannot be switched.
- Server Script:
The server methods of the IServerApi will be processed but cannot be sent to the Client which are:
 - AlarmManager
 - AnalogMonitorManager
 - CameraManager
 - CompoundEventManager
 - DecoderManager
 - DeviceManager
 - DomeCameraManager
 - EventManager
 - InputManager
 - LicenseManager
 - Logbook
 - MatrixManager
 - RecorderManager
 - RelayManager
 - ScheduleManager
 - SendManager
 - SequenceManager
 - VirtualInputManager
- State overlays:
No state overlays of cameras, inputs or relays are available.

Device state overlay

The device states (recording dot, too noisy, too dark, ...) are processed by the Management Server. On disconnection between Client and Server the states cannot be updated in the Client. A new state overlay will give you a visual feedback that all device states are not available at the moment. If the client has an established connection to the server again, the state overlays are updated automatically.

-  State unknown
The state overlay of a device in the Logical Tree or on a map when client is disconnected from the Management Server computer.

Reasons for disconnection

Reasons for disconnection between Operator Client and Management Server can be:

- Physical connection is broken.
- Password of logged on user has changed during offline time.
- Management Server has given away floating workstation license to another online Operator Client while the now disconnected Operator Client was offline.
- Operator Client and Management Server have different versions (Management Server earlier than version 5.5).

25.18 Permissions for logon per application type page

Main window > **User groups** > **User groups** tab >  > **Application permissions** tab > **Permissions for logon per application type** tab
or

Main window > **User groups** > **Enterprise User Groups** tab >  > **Application permissions** tab > **Permissions for logon per application type** tab

Allows you to configure various user permissions for the different applications.

Operator Client or Cameo SDK (direct to Management Server)

Select the check box to allow direct logon to the Management Server of the Operator Client or Cameo SDK application.

Operator Client (to Unmanaged Site)

Select the check box to allow the logon to Operator Client application by connecting to an unmanaged site.

Configuration Client

Select the check box to allow logon to Configuration Client application.

Configuration API

Select the check box to allow logon to **Configuration API**.

Mobile access by web browser

Select the check box to allow mobile access by web browser.

Mobile access by Video Security Client

Select the check box to allow mobile access by Video Security Client.

BVMS Server SDK

Select the check box to allow logon to BVMS server SDK application.

BVMS Client SDK (allows connection to Operator Client)

Select the check box to allow logon to Client SDK application for certain user groups.

25.19 Threat management settings page

Main window > **User groups** > **User groups** tab >  > **Threat management** tab > **Settings** tab

Allows you to configure if a group membership should change based on different threat levels.

Note: In case of a threat level alarm, the current Operator Client user is logged off and the Operator Client restarts. The user has to log in again to the Operator Client in threat level mode. Depending on the configuration of the user group, the corresponding user then will get the permissions of the configured user group for the active threat level.

To configure a threat level for a user group:

1. Select the respective user group.
2. In the respective threat level dropdown menu, select the user group that should be active in this threat level.

26 Configuring users, permissions and Enterprise Access



Notice!



BVMS Viewer offers only basic features. Advanced features are included in BVMS Professional. For detailed information about the different BVMS editions refer to www.boschsecurity.com and the BVMS Quick Selection Guide: [BVMS Quick Selection Guide](#).

Main window > **User groups**

This chapter provides information on how to configure user groups, Enterprise User Groups and Enterprise Access.

You configure all device permissions and operating permissions per user group and not per user.

The following rules apply:

- A BVMS user can only be the member of one BVMS user group or Enterprise User Group. An LDAP user can be member of several LDAP user groups.
- You cannot change the settings of a default user group.
- This user group has access to all the devices of the Full Logical Tree and is assigned the **Always** schedule.
- For accessing the Windows user groups of a domain, LDAP user groups are used.
- Click  to save the settings.
- Click  to undo the last setting.
- Click  to activate the configuration.

Strong password policy

To enhance the protection of your computer against unauthorized access, it is recommended to use strong passwords for user accounts.

Hence a strong password policy is enabled by default for all newly created user groups. This includes admin user group as well as standard user groups, Enterprise user groups and Enterprise Access.

The following rules apply:

- Minimum password length as set on the **Account policies** page for the appropriate user group.
- Do not use one of the previous passwords.
- Use at least one upper-case letter (A through Z).
- Use at least one number (0 through 9).
- Use at least one special character (for instance: ! \$ # %).

When the Admin user starts Configuration Client for the first time, the **Password policy is violated** dialog box is displayed asking him to set a password for the Admin user account. We highly recommend to keep this setting and to set a strong password for the Admin user account according to the password policy rules.

When creating new user groups in Configuration Client the strong password policy setting is enabled by default. If you do not set passwords for the new user accounts of the appropriate user group, you cannot activate the configuration. The **Password policy is violated** dialog box is displayed listing all users for whom no password has been set.

To activate the configuration, set the missing passwords.

Refer to

- *Account policies page, page 326*
- *User Group Properties page, page 313*
- *User Properties page, page 313*
- *Logon Pair Properties page, page 314*
- *Camera Permissions page, page 315*
- *Control Priorities page, page 316*
- *Copy User Group Permissions dialog box, page 316*
- *Decoder Permissions page, page 317*
- *Events and Alarms page, page 317*
- *LDAP Server Settings dialog box (Settings menu), page 115*
- *Credentials page, page 318*
- *Logical Tree page, page 318*
- *Operator Features page, page 319*
- *Priorities page, page 322*
- *User Interface page, page 322*
- *Server Access page, page 323*

26.1 Creating a group or account

Main window > **User groups**

You can create a standard user group, an Enterprise User Group or an Enterprise Account. For adapting the user group permissions to your requirements, create a new user group and change its settings.

26.1.1 Creating a standard user group

Main window > **User groups**

To create a standard user group:

1. Click the **User groups** tab.
2. Click .
The **New user group** dialog box is displayed.
3. Type in the name and a description.
4. Click **OK**.
A new group is added to the corresponding tree.
5. Right-click the new user group and click **Rename**.
6. Enter the desired name and press ENTER.

Refer to

- *User Group Properties page, page 313*
- *Operator Features page, page 319*
- *Priorities page, page 322*
- *User Interface page, page 322*

26.1.2 Creating an Enterprise User Group

Main window > **User groups**

You perform the task of creating an Enterprise User Group for an Enterprise System on the Enterprise Management Server.

You create an Enterprise User Group with users to configure their operating permissions. These operating permissions are available on an Operator Client that is connected to the Enterprise Management Server. An example of an operating permission is the user interface of the alarm monitor.

To create an Enterprise User Group:

1. Click the **Enterprise User Groups** tab.
Note: The **Enterprise User Groups** tab is only available if the appropriate license is available and if one or more Management Server computers are configured in **Devices > Enterprise System > Server List / Address Book**.
2. Click .
 The **New enterprise user group** dialog box is displayed.
3. Type in the name and a description.
4. Click **OK**.
 The Enterprise User Group is added to the corresponding tree.
5. Right-click the new Enterprise group and click **Rename**.
6. Enter the desired name and press ENTER.
7. On the **Operating permissions** page, configure the operating permissions and server access for the configured Management Server computers as required.

Refer to

- *User Group Properties page, page 313*
- *Operator Features page, page 319*
- *Priorities page, page 322*
- *User Interface page, page 322*
- *Server Access page, page 323*

26.1.3

Creating an Enterprise Account

Main window > **User groups**



Notice!

At least one device must be configured in the Device Tree before you can add an Enterprise Account.

You perform the task of creating an Enterprise Account on a Management Server. Repeat this task on each Management Server that is a member of your Enterprise System.

You create an Enterprise Account to configure the device permissions for an Operator Client using an Enterprise System.

To create an Enterprise Account:

1. Click the **Enterprise Access** tab.
2. Click .
 The **New Enterprise Account** dialog box is displayed.
3. Type in the name and a description.
4. The **User must change password at next logon** check box is pre-selected for all newly created user accounts.
 Type the key according to the key policy rules and confirm this key.
5. Click **OK**.
 A new Enterprise Account is added to the corresponding tree.

6. Right-click the new Enterprise Account and click **Rename**.
7. Enter the desired name and press ENTER.
8. On the **Device permissions** page, configure the credentials and the device permissions as required.

Refer to

- *Strong password policy , page 332*
- *Credentials page, page 318*
- *Logical Tree page, page 318*
- *Events and Alarms page, page 317*
- *Control Priorities page, page 316*
- *Camera Permissions page, page 315*
- *Decoder Permissions page, page 317*

26.2 Creating a user

Main window > **User groups** > **User groups** tab

or

Main window > **User groups** > **Enterprise User Groups** tab



You create a user as a new member of an existing standard user group or Enterprise User Group.



Notice!

A user who wants to operate a Bosch IntuiKey keyboard connected to a decoder, must have a number-only user name and password. The user name can have maximum 3 numbers; the password can have maximum 6 numbers.

To create a user:

1. Select a group and click  or right-click the desired group and click **New user**.
A new user is added to the **User groups** tree.
2. Right-click the new user and click **Rename**.
3. Enter the desired name and press ENTER.
4. On the **User Properties** page, type the user name and a description.
5. The **User must change password at next logon** check box is pre-selected for all newly created user accounts.
Type the password according to the password policy rules and confirm this password.
6. Click **Apply** to apply the settings.
7. Click  to activate the password.
8. Click  to activate the configuration.

Note: After adding a new user, you always have to activate the configuration.

Refer to

- *User Properties page, page 313*
- *Strong password policy , page 332*
- *User Groups page, page 311*

26.3 Creating a dual authorization group

Main window > **User groups** > **User groups** tab

or

Main window > **User groups** > **Enterprise User Groups** tab

You can create a dual authorization for a standard user group or for an Enterprise User Group. For Enterprise Access, a dual authorization is not available.

You select two user groups. The members of these user groups are the members of the new dual authorization group.

To create a dual authorization group:

1. Click .

The **New dual authorization group** dialog box respectively the **New enterprise dual authorization group** dialog box is displayed.
2. Type in a name and a description.
3. Click **OK**.

A new dual authorization group is added to the corresponding tree.
4. Right-click the new dual authorization group and click **Rename**.
5. Enter the desired name and press ENTER.

Refer to

- *Adding a logon pair to dual authorization group, page 336*
- *User Group Properties page, page 313*
- *Operator Features page, page 319*
- *Priorities page, page 322*
- *User Interface page, page 322*

26.4

Adding a logon pair to dual authorization group

Main window > **User groups** > **User groups** tab >  **New dual authorization group**

Main window > **User groups** > **Enterprise User Groups** tab >  **New enterprise dual authorization group**

To add a logon pair to a dual authorization group:

1. Select the desired dual authorization group and click  or right-click the group and click **New logon pair**.

The appropriate dialog box is displayed.
2. Select a user group in each list.

The users of the first user group are the users that must log on in the first dialog box for logging on, the users of the second user group confirm the logon.

It is possible to select the same group in both lists.
3. For each group, select **Force dual authorization** if required.

When this check box is selected, each user of the first group can only log on together with a user of the second group.

When this check box is cleared, each user of the first group can log on alone but he only has the access rights of his group.
4. Click **OK**.

A new logon pair is added tot he appropriate dual authorization group.
5. Right-click the new logon pair and click **Rename**.
6. Enter the desired name and press ENTER

Refer to



- *Creating a dual authorization group, page 335*
- *Logon Pair Properties page, page 314*

26.5**Configuring Admin Group**

Main window > **User groups** > **User groups** tab  Admin Group

Allows you to add new admin users to the Admin Group, to rename admin users and to remove them from the Admin Group.

To add a new admin user to the Admin Group:

1. Click  or right-click the Admin Group and click **Add new user**.
A new admin user is added to the Admin Group.
2. On the **User Properties** page, type the user name and a description.
3. The **User must change password at next logon** check box is pre-selected for all newly created user accounts.
Type the password according to the password policy rules and confirm this password.
4. Click **Apply** to apply the settings.
5. Click  to activate the password.

To rename an admin user:

1. Right-click the desired admin user and click **Rename**.
2. Enter the desired name and press ENTER.
3. Click  to activate the user name changes.

To remove an admin user from the Admin Group:

- ▶ Right-click the desired admin user and click **Remove**.
The admin user is removed from the Admin Group.

Note:

You can remove an admin user from the Admin Group only if other admin users exist. If there is a single admin user in the Admin group it cannot be removed.

Refer to

- *User Groups page, page 311*
- *User Properties page, page 313*
- *Strong password policy, page 332*

26.6**Selecting an associated LDAP group**

Main window > **User groups** > **User groups** tab >  > **Operating permissions** tab > **User group properties** tab
or

Main window > **User groups** > **Enterprise User Groups** tab >  > **Operating permissions** tab > **Enterprise user group properties** tab
You configure LDAP groups in standard user groups or Enterprise User Groups.

To select an associated LDAP group:

1. Click the **Search for groups** button.
2. In the **Associated LDAP group** list, select the respective LDAP group.

For detailed information on the various fields, follow the link to the appropriate application window below.

Refer to

- *LDAP Server Settings dialog box (Settings menu), page 115*
- *User Group Properties page, page 313*

26.7**Scheduling user logon permission**

Main window > **User groups** > **User groups** tab >  > **Operating permissions** tab > **User group properties** tab
or

Main window > **User groups** > **Enterprise User Groups** tab >  > **Operating permissions** tab > **Enterprise user group properties** tab

You can limit the members of a user group or Enterprise User Group to log on to their computers at specified time periods.

You cannot change these settings for a default user group.

To schedule logging on:

1. Click the **User group properties** tab.
2. In the **Logon schedule** list, select a schedule.

26.8**Configuring operating permissions**

Main window > **User groups** > **User groups** tab >  > **Operating permissions** tab > **User group properties** tab
or

Main window > **User groups** > **Enterprise User Groups** tab >  > **Operating permissions** tab > **Enterprise user group properties** tab

- You can configure operating permissions like Logbook access or user interface settings.
- You cannot change these settings for a default user group.
- You configure operating permissions in standard user groups or Enterprise User Groups.

For detailed information on the various fields, see the Online Help for the appropriate application window.

For detailed information on the various fields, follow the link to the appropriate application window below.

Refer to

- *User Group Properties page, page 313*
- *Operator Features page, page 319*
- *Priorities page, page 322*
- *User Interface page, page 322*
- *Server Access page, page 323*

26.9**Configuring device permissions**

Main window > **User groups** > **User groups** tab > **Device permissions** tab

or

Main window > **User groups** > **Enterprise Access** tab > **Device permissions** tab

You can set the permissions for all devices of the Logical Tree independently.

After you have moved permitted devices to a folder that is not permitted for this user group, you must set the permissions for the folder to grant access to its devices.

- You cannot change these settings for a default user group.
- You configure device permissions in standard user groups or Enterprise Accounts.

For detailed information on the various fields, see the Online Help for the appropriate application window.

For detailed information on the various fields, follow the link to the appropriate application window below.

Refer to

- *Logical Tree page, page 318*
- *Events and Alarms page, page 317*
- *Control Priorities page, page 316*
- *Camera Permissions page, page 315*
- *Decoder Permissions page, page 317*

26.10 Configuring various priorities

Main window > **User groups** > **User groups** tab

or

Main window > **User groups** > **Enterprise User Groups** tab

or

Main window > **User groups** > **Enterprise Access** tab

You can configure the following priorities:

- For standard user groups and **Enterprise User Groups**: You can configure the alarm priorities for Live Mode and Playback Mode.
- For standard user groups and **Enterprise Access**: You can configure the priorities for acquiring PTZ controls and Bosch Allegiant trunk lines.
You can configure a time period for PTZ locking, i.e. a user with higher priority can take over the camera control from a user with a lower priority and locks it for this time period.

To configure live and playback priorities:

1. Select a standard user group or an Enterprise User Group.
2. Click **Operating permissions**.
3. Click the **Priorities** tab.
4. In the **Automatic popup behavior** field, move the sliders as required.

To configure priorities for PTZ and Bosch Allegiant trunk lines:

1. Select a standard user group or an Enterprise Account.
2. Click **Device permissions** tab.
3. Click the **Control priorities** tab.
4. In the **Control priorities** field, move the sliders as required.
5. In the **Timeout in min.** list, select the required entry.

Refer to

- *Control Priorities page, page 316*
- *Priorities page, page 322*

26.11 Copying user group permissions

Main window > **User groups** > **User groups** tab

or

Main window > **User groups** > **Enterprise User Groups** tab

or

Main window > **User groups** > **Enterprise Access** tab

You can copy permissions from one group or account to another. You must have configured at least 2 groups or accounts.

To copy permissions:

1. In the User Groups tree, select a group or account.

2. Click  .

The **Copy User Group Permissions** dialog box is displayed.

3. Select the appropriate permissions and the appropriate target group or account.
4. Click **OK**. The group permissions of this group are copied to the other group or account. The dialog box is closed.

27 Configuring video-based fire alarm detection

For configuring a video-based fire alarm you must perform the following steps:

1. Configure a fire detection on your fire detection camera.
 You use the Webpage of the camera for this configuration.
 For detailed information on configuring a fire detection camera, see
 - *Configuring a fire detection camera, page 341*
2. Add this fire detection camera to the system. You can add the fire detection camera to a VRM pool, as a live only encoder, or as a local storage encoder.
 For detailed information on adding a camera, see
 - *Adding an encoder to a VRM pool, page 210*
 - *Adding a live only encoder, page 211*
 - *Adding a local storage encoder, page 211*
3. Configure a fire event for this camera.
 - *Configuring a fire event, page 343*
4. Configure the alarm for the fire event.
 - *Configuring a fire alarm, page 343*

Refer to

- *Adding an encoder to a VRM pool, page 342*
- *Adding a live only encoder, page 211*
- *Adding a local storage encoder, page 211*
- *Configuring a fire event, page 343*
- *Configuring a fire alarm, page 343*

27.1 Configuring a fire detection camera

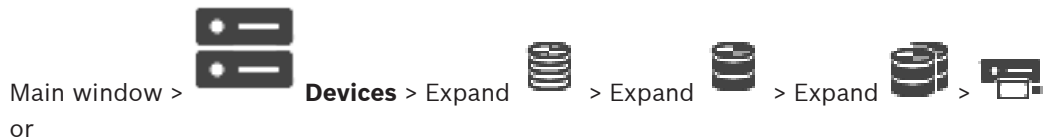

For configuring a video-based fire alarm, you must first configure the fire detection on the fire detection camera.

For details see the Operation Manual of your fire detection camera.

To configure:

1. Right-click the device icon and click **Show webpage in browser**.
2. Click **Configuration**.
3. On the navigation pane, expand **Alarm** and click **Fire detection**.
4. Perform the desired settings.

27.2 Adding an encoder to a VRM pool

To add encoders to a VRM pool, see *Adding Encoders via scan*, page 174.

Refer to

- *Adding a device*, page 123

27.3 Adding Encoders via scan

To add encoders via scan:

1. Right-click  and click **Scan for Encoders**.
The **BVMS Scan Wizard** dialog box is displayed.
2. Select the required encoders, select the desired VRM pool and click **Assign** to assign them to the VRM pool.
3. Click **Next >>**.
The **Authenticate Devices** dialog box of the wizard is displayed.
4. Type in the password for each device that is protected by a password.
Password check is performed automatically, when you do not enter a further character in the password field for a few seconds or you click outside the password field.
If the passwords of all devices are identical, you can enter it in the first **Password** field.
Then right-click this field and click **Copy cell to column**.

In the **Status** column, the successful logons are indicated with .

The failed logons are indicated with .

5. Click **Finish**.
The device is added to the Device Tree.

The  icon indicates an error that you need to take care of. Check the tool tip for more information about the specific error.

27.4 Adding live only devices via scan

To add Bosch live only devices via scan:

1. Right-click  and click **Scan for Live Only Encoders**.
The **BVMS Scan Wizard** dialog box is displayed.
2. Select the desired check boxes for the devices that you want to add.
3. Click **Next >>**.
The **Authenticate Devices** dialog box of the wizard is displayed.
4. Type in the password for each device that is protected by a password.
Password check is performed automatically, when you do not enter a further character in the password field for a few seconds or you click outside the password field.
If the passwords of all devices are identical, you can enter it in the first **Password** field.
Then right-click this field and click **Copy cell to column**.



In the **Status** column, the successful logons are indicated with .

The failed logons are indicated with .

- Click **Finish**.
The device is added to the Device Tree.

The  icon indicates an error that you need to take care of. Check the tool tip for more information about the specific error.

27.5 Adding local storage encoders via scan

Main window > **Devices** > Expand  > 
Allows you to add and configure encoders with local storage.

To add local storage encoders via scan:

- In the Device Tree right-click  and click **Scan for Local Storage Encoders**.
The **BVMS Scan Wizard** dialog box is displayed.
- Select the desired check boxes for the devices that you want to add.
- Click **Next >>**.
The **Authenticate Devices** dialog box of the wizard is displayed.
- Type in the password for each device that is protected by a password.
Password check is performed automatically, when you do not enter a further character in the password field for a few seconds or you click outside the password field.
If the passwords of all devices are identical, you can enter it in the first **Password** field.
Then right-click this field and click **Copy cell to column**.

In the **Status** column, the successful logons are indicated with .

The failed logons are indicated with .

- Click **Finish**.
The device is added to the Device Tree.

27.6 Configuring a fire event

Main window >  **Events**

To configure:

- In the tree, select **Encoders/Decoders > Camera > Fire or Smoke State > Fire or Smoke detected**.
The corresponding Event Configuration Table is displayed.
- In the **Trigger Alarm - Schedule** column, click a cell and select the appropriate schedule.
The schedule determines when the alarm is triggered.
Select one of the Recording Schedules or Task Schedules that you have configured in the **Schedules** page.
- Make the required settings.

Note: You can use the same procedure for the other available fire events.

27.7 Configuring a fire alarm

Main window > **Alarms**

To configure:

1. In the tree, select **Encoders/Decoders > Camera > Fire or Smoke State > Fire or Smoke detected.**
The corresponding Alarm Configuration Table is displayed.
2. Make the required settings.

28

Configuring MIC IP 7000 connected to a VIDEOJET 7000 connect

For operating a MIC IP 7000 camera connected to a VIDEOJET 7000 connect, you must perform the following configuration for proper working.

Before you add the MIC IP camera to BVMS, perform the following tasks:

1. Reset both the MIC IP 7000 camera and the VIDEOJET 7000 connect device to the factory default settings on the Web page of each device.
2. Set the MIC IP 7000 camera to the **MIC IP Starlight 7000 HD-VJC-7000** variant.
3. Configure the MIC IP 7000 camera and the VIDEOJET 7000 connect device according to the documentation delivered with the devices.
4. If you want to use ANR, execute the ANR Setup Utility for the VIDEOJET 7000 connect device.

Perform this task on a computer being member of the same network as the VIDEOJET 7000 connect device.

You find the ANR Setup Utility on the product catalog page for the VIDEOJET 7000 connect device.

Perform this procedure to add and configure the MIC IP 7000 camera in BVMS:

1. In the Device Tree, add only the MIC IP 7000 camera.
You cannot add the VIDEOJET 7000 connect device to BVMS.
2. Right-click the just added camera and click **Edit Encoder**.
The **Edit Encoder** dialog box is displayed.
The device capabilities are automatically retrieved according to the variant configured above.
3. If required, configure ANR on the **Cameras and recording** page.

29 Troubleshooting

This chapter contains information on how to handle known problems using BVMS Configuration Client.

Problems during installation

Issue	Cause	Solution
Setup displays wrong characters.	The Windows language settings are not correct.	<i>Configuring the desired language in Windows, page 347</i>
Setup stops with a message that OPC Server cannot be installed.	OPC Server files cannot be overwritten.	Uninstall OPC Core Components Redistributable and restart BVMS Setup.
The software cannot be uninstalled by executing Setup.		Start Control Panel > Add/Remove Programs and uninstall BVMS.

Problems immediately after starting the application

Issue	Cause	Solution
BVMS displays the wrong language.	Windows is not switched to the desired language.	<i>Configuring the language of Configuration Client, page 74</i> or <i>Configuring the language of Operator Client, page 74</i>
The logon dialog box of Operator Client shows the wrong language.	Although you have changed the language for Operator Client in Configuration Client, the language for the logon dialog box of Operator Client depends on the Windows language.	<i>Configuring the desired language in Windows, page 347</i>

Problems with display language

Issue	Cause	Solution
Some display texts in Configuration Client or Operator Client are in a foreign language, usually English.	The OS language of the computer where the Management Server is installed, is often English. Hence, when the BVMS database is generated on this computer, many display texts are created in English. They remain unchanged regardless of the Windows language of an Operator Client computer. To avoid such language discrepancies, install	Do not change this.

Issue	Cause	Solution
	Management Server software on a computer with the desired Windows interface language.	

Problems with Bosch IntuiKey keyboard

Issue	Cause	Solution
The Bosch IntuiKey keyboard triggers an alarm and the softkey display displays Off Line.	The connection to the workstation is lost. Either the cable is damaged or unplugged, or the workstation has been reset.	<i>Reestablishing the connection to a Bosch IntuiKey keyboard, page 348</i>

Problems with the settings in the recording control of your soundcard

Issue	Cause	Solution
Feedbacks occur when using a microphone for Intercom functionality.	In the recording control of your soundcard the microphone must be selected, not the stereo mix (or something else). Operator Client checks its configuration file during startup and changes the settings in the recording control accordingly. This configuration file contains a default entry which might not match your system configuration. This setting is restored during each start of Operator Client.	Change the setting in the configuration file of Operator Client to microphone.

Crashing Configuration Client

Issue	Cause	Solution
Configuration Client crashes.	If there are many cameras configured in an Allegiant file which are not connected to Bosch Video Management System, you can reduce this number. This avoids unnecessary system load.	<i>See Reducing the number of Allegiant cameras, page 348.</i>

29.1 Configuring the desired language in Windows

If you want to change the display language for the setup of BVMS, you must switch the language in your Windows. For activating the language settings the computer is restarted after performing the following steps.

To configure the desired language:

1. Click **Start**, click **Control Panel**, and then double-click **Regional and Language Options**.
2. Click the **Advanced** tab, under **Language for non-Unicode programs**, select the desired language.
3. Click **OK**.
4. In each of the next message boxes, click **Yes**.
Your computer is restarted.

29.2 Reestablishing the connection to a Bosch IntuiKey keyboard

1. Plug in the cable again or wait until the workstation is online.
The Off Line message disappears.
2. Press the Terminal softkey to enter BVMS.

29.3 Reducing the number of Allegiant cameras

You need the Allegiant Master Control Software to edit the Allegiant file.

To reduce the number of Allegiant cameras:

1. Start the Master Control Software.
2. Open the Allegiant file.
3. Click the Camera tab.
4. Mark the cameras that are not required.
5. On the Edit menu, click Delete.
6. Save the file. The file size remains unchanged.
7. Repeat the last step for monitors that you do not need. Click the Monitors tab.
8. Import this file in Bosch Video Management System (refer to *Adding a device, page 123*).

29.4 Used ports

This section lists for all components of BVMS the ports that must be open within a LAN. Do not open these ports to the Internet! For operation via Internet use secure connections like VPN.

Each table lists the local ports that must be open on the computer where the server is installed or on the router/level 3 switch that is connected to the hardware.

On a Windows Firewall, configure an Inbound Rule for each open port.

Allow all outgoing connections for all BVMS software applications.

Management Server / Enterprise Management Server ports

Server (Listener)	Protocol	Inbound ports	Client (Requester)	Remark
Management Server	UDP	123	Encoder	TimeServer NTP
Management Server	TCP	5322	Operator Client,	SSH connection
Management Server	TCP	5389	ONVIF device	ONVIF proxy, event notification
Management Server	TCP	5390	Operator Client, Configuration Client	.NET Remoting
Management Server	TCP	5391	Operator Client, Configuration Client, NVR clients	Remoting port for all NVR services

Server (Listener)	Protocol	Inbound ports	Client (Requester)	Remark
Management Server	TCP	5392	Operator Client, Configuration Client, Mobile Video Service, BVMS SDK Application	WCF, gateway.push.apple.com
Management Server	TCP	5393	Operator Client, VRM, MVS	Data-Access-Service
Management Server	TCP	5394	Operator Client	Remoting port for Operator Client
Management Server	TCP	5395	Configuration Client, Operator Client	User preferences, File transfer
Management Server	TCP	5396	Configuration Client, WCF clients	Mex Entry point (normally switched off)
Management Server	TCP	5397	Operator Client for NoTouchDeployment	NoTouchDeployment port
Management Server	TCP	5398	Configuration API client	Internal communication between AKKA.Net component and CS
Management Server	UDP	12544	SNMP client	BVMS SNMP get port
Management Server	TCP	162	SNMP	
Management Server	TCP	5389 - 5396	BVMS ports	
Management Server	TCP, UDP	135	BRS DCOM	BRS
Management Server	TCP	808	BRS WebService (DIBOS)	Central Server connected to Dibos on this port when using WCF
Management Server	TCP	1756 / 1757	RCP	1757 for secondary VRM

Additional central components

Server (Listener)	Protocol	Inbound ports	Client (Requester)	Remark
Configuration Client	UDP	1024 - 65535	Encoder, VRM	Video Streaming
Configuration API	TCP	5399	REST API client	Configuration API

Server (Listener)	Protocol	Inbound ports	Client (Requester)	Remark
Management Server	TCP	5443	PID	PID connection, access via HTTPS
Workstation monitoring	TCP	5370	Operator Client, Management Server	
Workstation monitoring	TCP	5371	GRPC service	

Video Recording Manager ports

Server (Listener)	Protocol	Inbound ports	Client (Requester)	Remark
VRM	TCP	554 / 555	RTSP client	Retrieve primary / secondary RTSP stream
VRM	TCP	40023	Telnet client	Telnet (local host only from VRM 4.x)
VRM	TCP	40080 / 40081	VRM clien	HTTP port vj_generic.dll
VRM	TCP	41080 / 41081	VRM cient	HTTP vj_generic.dll (local host only)
VRM	TCP	1756 / 1757	Management Server, Configuration Client	via RCP+, (1757 for secondary VRM RCP+ client)
VRM	UDP	1757	Management Server, Operator Client	Scan Target Broadcast
VRM	UDP	1758	Management Server, Configuration Client	Scan Response
VRM	UDP	1759	Management Server, Configuration Client	Network discovery, Scan Target Multicast
VRM	UDP	1760		
VRM	UDP	1800 / 1900	Management Server, Operator Client	Scan Target Multicast
VRM	TCP	80	Operator Client	Primary VRM playback via http
VRM	TCP	443	Operator Client	Primary VRM playback via https
VRM	TCP	81	Operator Client	Secondary VRM playback via http
VRM	TCP	444	Operator Client	Secondary VRM playback via https

Bosch Video Streaming Gateway ports

Server (Listener)	Protocol	Inbound ports	Client (Requester)	Remark
Bosch Video Streaming Gateway	TCP	8080 - 8086	VRM, Management Server, Configuration Client, Operator Client	HTTP
Bosch Video Streaming Gateway	TCP	8443 - 8449	VRM, Management Server, Configuration Client, Operator Client	HTTPS
Bosch Video Streaming Gateway	TCP	8756 - 8762	VRM, Management Server, Configuration Client	RCP +
Bosch Video Streaming Gateway	TCP	8443-8449	VRM, Management Server, Configuration Client, Operator Client	HTTPS
Bosch Video Streaming Gateway	UDP	1757	VRM client	Scan Target Broadcast
Bosch Video Streaming Gateway	UDP	1758	VRM client	Scan Response
Bosch Video Streaming Gateway	UDP	1759	VRM client	Network discovery, Scan Target Multicast
Bosch Video Streaming Gateway	UDP	1800, 1900	VRM Configuration Client	Network discovery, Scan Target Multicast
Bosch Video Streaming Gateway	UDP	1064-65535	Encoder, VRM	Video streaming

Mobile Video Service ports

Server (Listener)	Protocol	Inbound ports	Client (Requester)	Remark
Mobile Video Service	TCP	80	Management Server, Operator Client, Configuration Client, HTML Client, Mobile Apps	Primary VRM playback via HTTP
Mobile Video Service	TCP	443	Management Server, Operator Client, Configuration Client, HTML Client, Mobile Apps	Primary VRM playback via HTTPS
Mobile Video Service	TCP	2195	Apple Push Notification	Mac iOS

Server (Listener)	Protocol	Inbound ports	Client (Requester)	Remark
Mobile Video Service	UDP	1064-65535	Encoder, VRM	Video streaming
Mobile Video Service transcoder	TCP	5382	Mobile Video Service mobile provider	Media stream
Mobile Video Service BVMS provider	TCP	5383	Operator Client	Media stream
Mobile Video Service BVMS provider	TCP	5384	HTML client, mobile apps	Media stream
Mobile Video Service transcoder	TCP	5385	Mobile Video Service mobile provider	Media stream

iSCSI Storage System ports

Configure port forwarding at the connected router for this device.

Server (Listener)	Protocol	Inbound ports	Client (Requester)	Remark
iSCSI storage system	TCP	3260	Encoder, VRM, Configuration Client, Operator Client	iSCSI storage system

DVR ports

Configure port forwarding at the connected router for this device.

Server (Listener)	Protocol	Inbound ports	Client (Requester)	Remark
DVR	TCP	80	Management Server, Configuration Client, Operator Client	Access via HTTP
DVR	TCP	443	Management Server, Configuration Client, Operator Client	Access via HTTPS

ONVIF camera / camera / encoder ports

Configure port forwarding at the connected router for this device.

Server (Listener)	Protocol	Inbound ports	Client (Requester)	Remark
Encoder	TCP	80	Management Server, VSG, Configuration Client, Operator Client	Access via HTTP

Server (Listener)	Protocol	Inbound ports	Client (Requester)	Remark
Encoder	TCP	443	Management Server, VSG, Configuration Client, Operator Client	Access via HTTPS
Encoder	UDP	123	Management Server, VRM	SNTP
Encoder	UDP	161	Management Server, VRM	SNMP
Encoder	TCP	554	Operator Client, BVMS SDK application, VSG	RTSP streaming
Encoder	TCP	3260	Encoder (outbound)	iSCSI recording
Encoder	TCP	1756	Decoder, Management Server, Operator Client	Outgoing connection for the Bosch cameras
Encoder	UDP	1757	Decoder, Management Server, Operator Client	Scan Target Broadcast
Encoder	UDP	1758	Decoder, Management Server, Operator Client	Scan Response
Encoder	UDP	1800	Decoder, Management Server, Operator Client	Network discovery, Scan Target Multicast
Encoder	UDP	1900		SSDP (optional encoder port)
Encoder	UDP	21		FTP (optional encoder port)
Encoder	UDP	3702		UPNP (optional encoder port)
Encoder	UDP	9554		SRTSP (optional encoder port)
Encoder	UDP	15344 / 15345		RTSP send (optional encoder port)

BVMS decoder ports

Configure port forwarding at the connected router for this device.

Server (Listener)	Protocol	Inbound ports	Client (Requester)	Remark
Decoder	TCP	1756	Management Server, Operator Client, Configuration Client, BVMS SDK Application	Outgoing connection for the Bosch cameras
Decoder	UDP	1757	Management Server, Operator Client	Scan Target Broadcast
Decoder	UDP	1758	Management Server, Operator Client	Scan Response
Decoder	UDP	1800	Management Server, Operator Client	Network discovery, Scan Target Multicast
Decoder	TCP	80	Operator Client	Access via HTTP

Server (Listener)	Protocol	Inbound ports	Client (Requester)	Remark
Decoder	TCP	443	Operator Client	Access via HTTPS
Decoder	UDP	1024-65535	Encoder	Streaming ports
Decoder	UDP	123	Management Server, VRM	SNTP
Decoder	UDP	161	Management Server, VRM	SNMP

BVMS Operator Client / Cameo SDK ports

Server (Listener)	Protocol	Inbound ports	Client (Requester)	Remark
Operator Client	TCP	5394	BVMS SDK application, BIS	WCF
Operator Client	UDP	1024-65535	Encoder, VRM	Video streaming
Operator Client	TCP	40082		
Operator Client	TCP	41756		

LPR, BVMS Device Adapter ports

Server (Listener)	Protocol	Inbound ports	Client (Requester)	Remark
BVMS Device Adapter	TCP	31000	LPR camera client	VRC

AMS, Access Management System ports

Server (Listener)	Protocol	Inbound ports	Client (Requester)	Remark
AMS	TCP	62904	Management Server	Access via HTTPS

Transcoder

Server (Listener)	Protocol	Inbound ports	Client (Requester)	Remark
	UDP	5080		
	UDP	5443		
	UDP	5756		

29.5 Enabling logging for ONVIF events



Notice!

Be aware that this feature is soon end of life.

Use the ONVIF Camera Event Driver Tool for easy ONVIF event mapping.

See *Starting ONVIF Camera Event Driver Tool from Configuration Client*, page 202.

You can enable logging for ONVIF events for example when you encounter problems with receiving BVMS events. Logging then helps you to find the issue.

To enable logging:

1. Open the file %programfiles%\Bosch\VMS\AppData\Server\CentralServer\BVMSLogCfg.xml in an appropriate editor, for example Notepad. Run the Notepad application as administrator.
2. Navigate to the line containing the following string:
Add logging for onvif events of a device by network address
The commented lines contain a brief explanation.
3. As the logger name, type in OnvifEvents.<Networkaddress>.
Type in only OnvifEvents to log the events for all ONVIF devices.
4. As level value, type in DEBUG for all incoming and outgoing events.
Type in INFO for all outgoing events.
Type in WARN or ERROR to disable.

Note: The activation might require a restart of the central server.

The following lines show an example for logging the events from device 172.11.122.22 with all outgoing and incoming events:

```
<logger name="OnvifEvents.172.11.122.22" additivity="false">
<level value = "DEBUG"/>
<appender-ref ref="OnvifRollingFileAppender"/>
</logger>
```

**Support**

Access our **support services** at www.boschsecurity.com/xc/en/support/.

Bosch Security and Safety Systems offers support in these areas:

- [Apps & Tools](#)
- [Building Information Modeling](#)
- [Warranty](#)
- [Troubleshooting](#)
- [Repair & Exchange](#)
- [Product Security](#)

**Bosch Building Technologies Academy**

Visit the Bosch Building Technologies Academy website and have access to **training courses**, **video tutorials** and **documents**: www.boschsecurity.com/xc/en/support/training/

Refer to

- *Starting ONVIF Camera Event Driver Tool from Configuration Client, page 202*
- *Configuring an ONVIF mapping table, page 230*
- *ONVIF event mapping, page 42*

Glossary

Alarm

Event that is configured to create an alarm. This is a particular situation (motion detected, doorbell rung, signal lost, etc.) that requires immediate attention. An alarm can display live video, playback video, an action plan, a web page, or a map.

Alarm Image window

Image window for displaying one or more Alarm Image panes.

Alarm List

Window in Bosch Video Management System used to display a list of active alarms.

Allegiant

Bosch family of analog matrix switching systems.

ANR

Automated Network Replenishment. Integrated process that copies missing video data from a video transceiver to the network video recorder after a network failure. The copied video data exactly fills the gap that occurred after the network failure. Hence the transceiver needs any kind of local storage. The recording capacity on this local storage is calculated with the following formula: $(\text{network bandwidth} \times \text{estimated network downtime} + \text{safety margin}) \times (1 + 1/\text{backup speed})$. The resulting recording capacity is required because the continuous recording must continue during the copy process.

area

A group of detection devices connected to the security system.

ATM

Automatic Teller Machine

B-frame

Bidirectional frame. Part of a video compression method.

BIS

Building Integration System

bypass/unbypass

To bypass a device means to ignore any alarms that it may generate, usually for the duration of some extenuating circumstances such as maintenance. To unbypass means to stop ignoring them.

CCL emulation

Emulation of the Command Console Language used for controlling an Allegiant matrix. You can use this set of commands to switch a BVMS IP camera / encoder to a BVMS IP decoder. You cannot control old analog cameras or the Allegiant matrix itself directly.

Command Script

Macro, that the administrator can program to build an automatic action like positioning a PTZ camera or send E-mails. For that functionality Bosch Video Management System provides a specific set of commands. Command Scripts are divided into Client Scripts and Server Scripts. Client Scripts are used on client workstations to execute certain tasks that can run on a client workstation. Server Scripts are executed automatically by an event that was triggered in the system. They get arguments provided by the event like date and time. A Command Script can consist of several scriptlets. You can create a Command Script using the following scripting languages: C#, VB.Net. Command Scripts are executed in response to events or alarms automatically according to a schedule (Server Scripts only), manually from the Logical Tree, or manually from icons or on maps.

Compound Event

Combination of different events. The combination uses Boolean expressions, i.e. AND and OR. You can combine only state changes, for example the change of a connection state to disconnected or the activation of a schedule.

debounce time

Time period starting with the occurrence of an event. During this time period usually no other event of the same type is accepted. This prevents for example that a switching sensor creates a large number of events. For events with several states, you can configure a different priority

setting for each state. The following examples help you in getting a deeper understanding of the concept of debounce time. Example 1 deals with events creating the same state: The System Info event occurs and the configured debounce time starts. During this time another System Info event occurs. This System Info event is not accepted as a new event. Example 2 deals with events creating different states with the same priority: A Motion Detected event occurs and the configured debounce time starts. During this time, the Motion Stopped event with the same priority occurs. The Motion Stopped event is not accepted as a new event. Example 3 also deals with events creating different states with the same priority: The state of a virtual input is on. The state priorities for both state changes are identical. At a specific point in time, the virtual input is switched off, the debounce time is started. During this debounce time the virtual input is switched on. This state change is not accepted as a new event because it has the same priority. After the debounce time has elapsed, the virtual input is in another state. The switch-on gets the time stamp of the end of the debounce time and no new debounce time starts. Example 4 deals with events with different priorities creating different states: The Motion Detected event occurs and the configured debounce time starts. During this time the Motion Stopped event with a higher priority occurs. The Motion Stopped event is accepted as a new event but the debounce time does not start again. Example 5 also deals with events with different priorities creating different states: The state of a virtual input is off. The state priority for switched on is "5", for switched off is "2". At a specific point in time, the virtual input is switched on (prio "5"), the debounce time is started. During this debounce time the virtual input is switched off (prio "2"). This state change is accepted as a new event because it has a higher priority. The debounce time of the first switch-on is continued. Further state changes are not accepted during this debounce time.

decoder

Changes a digital stream to an analog stream.

Device Family

Bosch encoders / IP cameras can belong to one of the following device families: Device Family 1, Device Family 2, Device Family 3. Devices of Device Family 1 can only record stream 1. Devices of Device Family 2 can record stream 1 or stream 2. Devices of Device Family 3 can record stream 1, stream 2 or I-Frame only.

Device Tree

Hierarchical list of all the available devices in the system.

Dewarping

The use of software to convert a circular image from a fisheye lens with radial distortion to a rectilinear image for normal viewing (dewarping is the correction of distortion).

DNS

Domain Name System. A DNS server converts a URL (www.myDevice.com, for example) into an IP address on networks that use the TCP/IP protocol.

Document

The document files that are supported by BVMS are HTM, URL, MHT, HTML, TXT.

DTP

A DTP device (Data Transform Processor) transforms serial data of ATM devices to a defined data format and sends these data via Ethernet to BVMS. You must ensure that a transformation filter is set on the DTP device. This task is performed with a separate software from the manufacturer of the DTP device.

dual authorization

Security policy that requires two different users to log on to the Operator Client. Both the users must be member of a normal Bosch Video Management System user group. This user group (or these user groups if the users are members of different user groups) must be part of a dual authorization group. A dual authorization group has its own access rights within Bosch Video Management System. This dual authorization group should have more access rights than the normal user group that the user belongs to. Example: User A is member of a user group called Group A. User B is member of Group B. Additionally a dual

authorization group is configured with Group A and Group B as members. For the users of Group A, dual authorization is optional, for users of Group B it is mandatory. When user A logs on, a second dialog box for confirming the logon is displayed. In this dialog box, a second user can log on if he is available. If not, user A can continue and start the Operator Client. He then has only the access rights of Group A. When user B logs on, again a second dialog box for logging on is displayed. In this dialog box, a second user must log on. If not, user B cannot start the Operator Client.

Dual streaming

Dual streaming allows an incoming data stream to be encoded simultaneously according to two different, individually configured settings. This creates two data streams: one for live and pre-event recording, the other for continuous, motion, and alarm recording.

duplex

Term used to define the direction of data transmission between two parties. Half-duplex allows data transmission in both directions but not simultaneously. Full-duplex allows simultaneous data transmission.

DVR

Digital Video Recorder

Dwell time

Preset amount of time a camera is displayed in an Image window until the next camera is displayed during a camera sequence.

DWF

Design Web Format. Used to display technical drawings on a computer monitor.

DynDNS

Dynamic Domain Name System. A DNS host service that holds IP addresses ready in a database. Dynamic DNS allows you to connect to the device via the Internet using the host name of the device. See DNS.

Edge dewarping

Dewarping performed in the camera itself.

Encoder

Changes an analog stream to a digital stream, e.g., to integrate analog cameras in a digital system like Bosch Video Management System. Some encoders can have a local storage like a flash card, a USB hard disk, or they can store their video data on iSCSI devices. IP cameras have an encoder built in.

Enterprise Access

Enterprise Access is a feature of BVMS which consists of one or more Enterprise Accounts. Each Enterprise Account contains device permissions to devices of a particular Management Server.

Enterprise Account

Enterprise Account is an authorization that enables a user of Operator Client to connect to the devices of a Management Server being part of an Enterprise System. In an Enterprise Account, all permissions for the devices of this Management Server are configured. Operator Client can simultaneously connect to all Management Server computers that are part of this Enterprise System. This access is either controlled by the membership to an Enterprise User Group, and is controlled by the device permissions configured in the Enterprise Account for this Management Server.

Enterprise Management Server

Enterprise Management Server is a BVMS Management Server hosting the configuration of Enterprise User groups. You need one or more Enterprise User Groups referring to one or more servers computers. The roles of Enterprise Management Server and Management Server can be combined in one configuration.

Enterprise System

Enterprise System is a feature of Bosch Video Management System that allows a user of Operator Client to access multiple Management Server computers simultaneously.

Enterprise User Group

Enterprise User Group is a user group that is configured on an Enterprise Management Server. Enterprise User Group defines the users that are authorized to access multiple Management Server computers simultaneously. Defines the operating permissions available for these users.

Event

A circumstance or state that is linked to an alarm and/or an action. Events can arise from many sources such as cameras, archivers, directories, digital inputs, etc. They can include start-recording states, loss of signal states, disk full messages, user logons, digital input triggers, etc.

Failover VRM

Software in the BVMS environment. Takes over the task of the assigned Primary VRM or Secondary VRM in case of failure.

GSM

Global System for Mobile Communication. Standard for digital mobile phones.

H.264

Standard for encoding (compressing) digital audio and video for multimedia applications. This standard includes different profiles that can be manufacturer-dependent. The following profiles are available: Baseline, Baseline+, Main Profile. Baseline (not used in Bosch Video Management System) supports 2 CIF. Baseline+ supports 4 CIF and provides a better image quality than Baseline. Main Profile supports 4 CIF and provides a high efficient compression algorithm called CABAC (Context-adaptive binary arithmetic coding). This serves for high quality encoding for storage.

H.265

H.265 is a video compression standard defined by ISO2 and ITU3 and ratified on the 29th of October, 2014. It is seen as the successor of MPEG-4 AVC (Advanced Video Codec), also called H.264, to address the compression of resolutions from 4K and ultra HD up to 36 megapixels.

Hotspot

Mouse sensitive icon on a map. Hotspots are configured in Configuration Client. Hotspots can be for example cameras, relays, inputs. The operator uses it for localizing and selecting a device in a building. If configured, hotspots can display a blinking background color when a specific state event or alarm occurs.

I-frame

Intra frame. Part of a video compression method. Contains the information of a complete image, unlike P- or B-frames that contain information of the changes compared to the previous or next frame.

Image pane

Used for displaying live or recorded video of a single camera, a site map, a document, a sequence, a monitor group, an external application or a map viewport.

Image pane bar

Toolbar of an Image pane.

Image window

Container for Image panes, structured by an Image window pattern.

Instant playback

Plays the recorded image of the selected camera in an Image pane on the live screen. The start time (number of seconds in the past, or rewind time) can be configured.

Intercom functionality

Used to talk on the loudspeakers of an encoder. This encoder must have audio-in and audio-out. The Intercom functionality can be granted per user group.

intrusion control panel

Generic name for the core device in a Bosch intrusion (burglary) security system. Keypads, modules, detectors, and other devices connect to the control panel.

IPS

Images per second. Number of video images transmitted or recorded per second.

IQN

iSCSI Qualified Name. The initiator name in IQN format is used for provisioning addresses for both iSCSI initiators and targets. With IQN mapping you create an initiator group that controls the access to the LUNs on an iSCSI target and you write the initiator names of each encoder and the VRM into this initiator group. Only the devices whose initiator names are added to an initiator group are permitted to access a LUN. See LUN and see iSCSI.

iSCSI

Internet Small Computer System Interface. Protocol that manages storage via a TCP/IP network. iSCSI enables access to stored data from everywhere in the network. Especially with the advent of Gigabit Ethernet, it has become affordable to attach iSCSI storage servers simply as remote hard disks to a computer network. In iSCSI terminology, the server providing storage resources is called an iSCSI target, while the client connecting to the server and accessing the resources of the server is called iSCSI initiator.

JPEG

Joint Photographic Expert Group

JPEG

Joint Photographic Experts Group. Encoding process for still images.

LDAP

Lightweight Directory Access Protocol. Network protocol running over TCP / IP that allows accessing directories. A directory can be for example a list of user groups and their access rights. Bosch Video Management System uses it to get access to the same user groups as MS Windows or another enterprise user management system.

Live Mode

Feature of Operator Client. Used for live view of video.

Logbook

Container for logging all events in Bosch Video Management System.

Logical number

Logical numbers are unique IDs assigned to each device in the system for ease of reference. Logical numbers are only unique within a particular device type. Typical use of logical numbers are Command Scripts.

Logical Tree

Tree with a customized structure of all the devices. The Logical Tree is used in the Operator Client to select cameras and other devices. In the Configuration Client, the "Full Logical Tree" is configured (on the Maps and Structure page) and tailored for each user group (on the User Groups page).

LUN

Logical Unit Number. Used in the iSCSI environment to address an individual disk drive or a virtual partition (volume). The partition is part of a RAID disk array (the iSCSI target).

Management Server

BVMS server managing devices.

Map files

BVMS supports the following map files: PNG and JPG.

Map viewport

A map viewport is a region of the screen used to display a defined part of the global geolocation map.

Master Control Software

Software used as interface between Bosch Video Management System and an Allegiant device. Version 2.8 or greater is used.

MHT

Also called 'Web Archive'. File format that can save all HTML and image files of an Internet site in one file. To avoid problems we recommend to create MHT files with Internet Explorer 7.0 or higher only.

Mirrored VRM

Software in the BVMS environment. Special case of a Secondary VRM. Ensures that the recording performed by a Primary VRMs is additionally and simultaneously performed to another iSCSI target with the same recording settings.

monitor group

A set of monitors connected to decoders. The monitor group can be used for alarm processing in a given physical area. For example, an installation with three physically separated control rooms might have three monitor groups. The monitors in an monitor group are logically configured into rows and columns and can be set to different layouts, e. g. full-screen or quad view.

multipath

Technique in computer storage to have multiple physical paths defined that connect the data server to one storage target (using different controllers, buses switches or the like) as failover or load balancing solution (redundancy, efficiency).

multipathing

Usage of computer storage multipath technique.

Network monitoring

Measurement of network related values and evaluation of these values against configurable thresholds.

No-touch deployment

Method for automatic downloading, installing and running .NET applications without changing the registry or shared system components. With Bosch Video Management System, no-touch deployment is used for updating the Operator Clients from the Management Server. The update takes place if a new version is stored on the Management Server and when each user is logging on to the Operator Client. If you work with one Operator Client against multiple Management Server computers, no-touch deployment uses only the software version stored on the Management Server where the Operator Client has last logged on successfully. When you try to log on to another Management Server with a different application version, this one displays the Management Server as not online because the software versions do not match.

NVR

Bosch Network Video Recorder; computer in the Bosch Video Management System storing audio and video data, acting as Failover NVR, or as Redundant NVR. This NVR is different from the VIDOS NVR which can be integrated in Bosch Video Management System.

OID

Object Identifier. Term in the SNMP environment. Determines a MIB variable.

ONVIF

Open Network Video Interface Forum. Global standard for network video products. ONVIF conformant devices are able to exchange live video, audio, metadata, and control information and ensure that they are automatically discovered and connected to network applications such as video management systems.

Operator Client

Component of Bosch Video Management System that provides the user interface for system monitoring and operation.

Operator Client workstation

Computer in the Bosch Video Management System environment for viewing live and playback video and for configuration tasks. Operator Client is installed on this computer.

P-frame

Predicted frame. Part of a video compression method.

PID

Person identification device. It extracts characteristics of a person from an image, for example the face. It runs special algorithms that are able to identify a person within a video stream.

point

A detection device connected to the security system. Points show on the keypad individually and with custom text. The text might describe a single door, motion sensor, smoke detector, or an protected space such as UPSTAIRS or GARAGE.

Port

1) On computer and telecommunication devices, a port (noun) is generally a specific place for being physically connected to some other device, usually with a socket and plug of some kind. Typically, a personal computer is provided with one or more serial ports and usually one parallel port. 2) In programming, a port (noun) is a "logical connection place" and specifically, using the Internet protocol, TCP/IP, the way a client program specifies a particular server program on a computer in a network. Higher-level applications that use TCP/IP such as the Web protocol, Hypertext Transfer Protocol, have ports with preassigned numbers. These are known as "well-known ports" that have been assigned by the Internet Assigned Numbers Authority (IANA). Other application processes are given port numbers dynamically for each connection. When a service (server program) initially is started, it is said to bind to its designated port number. As any client program wants to use that server, it also must request to bind to the designated port

number. Port numbers are from 0 to 65535. Ports 1 to 1023 are reserved for use by certain privileged services. For the HTTP service, port 80 is defined as a default and it does not have to be specified in the Uniform Resource Locator (URL).

POS

Point of sale.

Primary VRM

Synonym for VRM.

PTZ camera

Camera with pan, tilt, and zoom function.

RAID

Redundant array of independent disks. Used for organizing two or more hard disks as if they were one drive. On such a drive data is shared or replicated. This is used to achieve greater capacity, reliability, and speed.

RCP

Remote Control Protocol

Recording Schedule

Used for scheduling recording and for scheduling some events like starting backup or limiting log on. Recording Schedules cannot have gaps or overlaps. It also determines the video recording quality.

Reference image

A reference image is continuously compared with the current video image. If the current video image in the marked areas differs from the reference image, an alarm is triggered. This allows you to detect tampering that would otherwise not be detected, for example if the camera is turned.

Rewind time

Number of seconds when an Image pane is switched to instant playback.

ROI

Region of Interest. Intended use of ROI is to save bandwidth when zooming into a section of the camera image with a fixed HD camera. This section behaves like a PTZ camera.

RTP

Real-Time Transport Protocol; a transmission protocol for real-time video and audio

RTSP

Real Time Streaming Protocol. A network protocol which allows to control the continuous transmission of audio-visual data or software over IP-based networks.

scopes

Scope is a term used in the field of ONVIF cameras. It is a parameter used for probing an ONVIF device. Usually the parameter contains a URI like the following: `onvif://www.onvif.org/<path>`. The parameter `<path>` can be for example `video_encoder` or `audio_encoder`. One ONVIF device can have multiple scopes. This URI denominates the task area of the device.

Secondary VRM

Software in the BVMS environment. Ensures that the recording performed by one or multiple Primary VRMs is additionally and simultaneously performed to another iSCSI target. The recording settings can deviate from the settings of the Primary VRM.

Server Lookup

Access method for a user of Configuration Client or Operator Client to sequentially connect to multiple system access points. A system access point can be a Management Server or an Enterprise Management Server.

Site map files

BVMS supports the following site map files: PNG, JPG, DPF and DWF.

Skimming

Sabotage of a foyer card reader. A skimming device reads the card data of the magnetic stripe without the knowledge of the cardholder.

SNMP

Simple Network Management Protocol. IP based protocol that allows to get information from networking devices (GET), to set parameters on network devices (SET) and to be notified about certain events (EVENT).

Task Schedule

Used for scheduling events which can occur in Bosch Video Management System, for example executing a Command Script. In Events you assign Task Schedules to events. For scheduling events you can also use Recording Schedules. With a

standard Task Schedule you configure time periods for every day of the week, for holidays, and for exception days. With a recurring Task Schedule you configure recurring time periods. They can recur every day, every week, every month, or every year.

TCP

Transmission Control Protocol

TCP/IP

Transmission Control Protocol / Internet Protocol. Also known as Internet protocol suite. Set of communication protocols used to transmit data over an IP network.

Text data

Data of a POS or ATM like date and time or bank account number stored with the corresponding video data to provide additional information for evaluation.

Trap

Term in the SNMP environment for an unrequested message from a monitored device (agent) to the network monitoring system (manager) about an event in this device.

Trunk line

Analog outputs of an analog matrix that are connected to an encoder device. Thereby matrix video sources can be used in the Bosch Video Management System.

UDP

User Datagram Protocol. A connectionless protocol used to exchange data over an IP network. UDP is more efficient than TCP for video transmission because of lower overhead.

unmanaged site

Item of the Device Tree in BVMS that can contain video network devices like Digital Video Recorders. These devices are not managed by the Management Server of your system. The user of Operator Client can connect to the devices of an unmanaged site on demand.

URI

Uniform Resource Identifier. String for identifying a network resource. Each URI consists of scheme, authority, path, query, fragment. Only scheme and fragment are mandatory for Mobile Video Service.

Example: `http:<scheme>//
example.com<authority>/over/therepath?<query>#nose<fragment>`

URL

Uniform Resource Locator

User group

User groups are used to define common user attributes, such as permissions, privileges and PTZ priority. By becoming a member of a group, a user automatically inherits all the attributes of the group.

VCA

Video content analysis: computer analysis of video streams to determine what is happening at the scene being monitored. See also Intelligent Video Analytics

Video Analytics

Video analytics is a software process that compares a camera image with the stored images of specific persons or objects. In case of a match, the software triggers an alarm.

Video resolution

Specification of horizontal and vertical pixels transferred with video signals. PAL: 1CIF = 352 x 288 2CIF = 704 x 288 4CIF = 704 x 576 QCIF = 176 x 144 NTSC 1CIF = 352 x 240 2CIF = 704 x 240 4CIF = 704 x 480 QCIF = 176 x 120 HD 720p = encoded 1280 x 720 1080p = encoded 1920 x 1080

Video Streaming Gateway (VSG)

Virtual device that allows integrating Bosch cameras, ONVIF cameras, JPEG cameras, RTSP encoders.

Virtual input

Used for forwarding events from third-party systems to Bosch Video Management System.

VRM

Video Recording Manager. Software package in Bosch Video Management System which manages storing video (MPEG-4 SH++, H.264 and H.265) with audio data and metadata on iSCSI devices in the network. VRM maintains a database containing the recording source information and a list of associated iSCSI drives. VRM is realized as a service running on a computer in the Bosch Video Management System network. VRM does not store

video data itself but distributes storage capacities on iSCSI devices to the encoders, while handling load balancing between multiple iSCSI devices. VRM streams playback from iSCSI to Operator Clients.

Workstation

In the BVMS environment: A dedicated computer where Operator Client is installed. This computer is configured as a workstation in Configuration Client to enable specific functions.

Index

A

Access control systems	159
access denied	
Allegiant CCL emulation	155
accessing the Help	14
acquire PTZ control	339
activate	93
Bosch Video Management System	76
previous configuration	94
activation	96
configuration	93
delayed	93, 105
add Bosch Allegiant input alarm	99
add Bosch ATM/POS bridge	98
add BVIP decoder	138, 178, 204
add BVIP encoder	138, 139, 178, 204, 213
add encoder	174, 183, 210, 342
add pool	
VRM	172
add text data to continuous recording	293
add unmanaged site	205, 206, 207
add video analytics device	161
add VRM	167
alarm map	295
alarm priority	339
alarm recording	295, 307, 308
alarm recording mode	281, 282
alarm sequence	295, 307
alarms	
sort order	295
Allegiant	
CCL emulation	124, 156
control channel	59, 60
firmware version	51, 52
Network Host program	59
PTZ camera	274
Satellite System	60
too many cameras	348
Allegiant CCL commands	61
Allegiant CCL emulation	156
access denied	155
Allegiant CCL Emulation page	155
Allegiant file	348
Allegiant matrix	123, 131, 132
all-in-one system	64
analog matrix	131
analog monitor group	120, 124
ANR	84, 219, 273

aspect ratio 16/9	322
ATM POS device	123
Audio Intercom functionality	320
automatic alarm popup behavior	41
automatic display of alarms	41
automatic logoff	120
automatic recording mode	176
automatic relogin	93
automatic restart	93

B

basic configuration	188
blinking device icons	290, 309
Bosch IntuiKey keyboard	51, 52, 55, 124, 134, 142, 153
Bosch Script API help	90
Bosch Video Management System	16
activate	76
GUI language	346
licensing	76
Online Help	14
overview	16
BVIP decoder	82, 212
add	138, 178, 204
BVIP device	
password	141, 210, 217
Web page	210
BVIP encoder	82, 212
add	138, 178, 204
BVIP encoder:add	139, 213
bypass	
point	321

C

CABAC	281
camera round	246, 255, 256
camera sequence	246, 255, 256
CCL emulation	156
CCTV keyboard	153
connection loss	347
change IP address	106, 123, 137, 220
change network address	137, 220
change password	141, 172, 210, 217, 313
change pool	218
chattering sensors	306
Client Command Script	
alarm accepted	299
executed on startup	91, 92, 135
CLL commands	156

codecs	281	disable enforced password protection	105
Command Script	246, 253	disconnected	328
Bosch Script API help	90	dome camera	284, 285
export	91	DSA E-Series	181, 182, 186, 187
import	91	DTP3N	148
Compatibility Mode	43	dual authorization	314
Compound Events	289, 305	dual recording	28, 183, 287
configuration data		dual streaming	136
export	94	duplicate IP addresses	105
configuration data to OPC		duplicating an event	303
export	95	DVR device	128
Configuration Wizard		E	
Mobile Video Service	64	E-mail device	123
configure VRM recording	99	empty password	93
connecting		encoder	
Allegiant matrix and BVMS	56	add	174, 183, 210, 342
Bosch IntuiKey keyboard and BVMS	52	Web page	210
connection string	120	encoder:failover recording mode	222
control of a camera	99, 281	encoding on NVRs	122, 169
copy and paste	276	enforced password protection	105
crash		Enterprise Management Server	324
Configuration Client	347	Enterprise System	23, 86
create		Enterprise user groups	311
Command Script	90	examples	98
customized events	289, 305	add Bosch Allegiant input alarm	99
D		add Bosch ATM/POS bridge	98
data sheet	20	configure VRM recording	99
DCZ keyboard	153	exception days	269
decoder		export	
Bosch IntuiKey keyboard	142	Camera Table	277
decoder:destination password	204, 217	Command Script	91
decoupled	328	configuration data	94
default configuration	188	configuration data to OPC	95
default IP address	105	MOV	319
default password	93, 105	F	
default stream	134, 273	failover recording mode	176
delayed activation	93, 105	encoder	222
delete user	313	Failover VRM	28, 125, 172
destination password	204, 217	filtering	107, 108, 109, 122, 247, 271, 289, 292, 294, 312
device capabilities		finding	
update	82, 212	devices	107, 108, 109, 122, 247, 271, 289, 292, 294, 312
device monitor	96	information in the Help	14
device replacement	78, 79	fire detection camera	341
Device Tree	122, 169, 246	Firewall	197
Devices pane	246	firmware upgrade	
devices without password protection	93	Bosch IntuiKey keyboard	55
DiBos device	123	Forensic Search	100, 134, 135
digital keyboard	153		
digital video recorder	123		

G			
global alarm settings		306	
global default password		73, 93, 105	
GUI language		346	
H			
H.264		281	
H.264 deblocking filter		281	
HD cameras		322	
help		14, 15	
holidays		269	
hotspots		246	
HTML files		246	
I			
I/O modules		124	
import			
Command Script		91	
resource files		249	
inactivity		120	
Independent Operator Client		327	
initial camera		144	
Intercom functionality		320	
interface settings			
VIP XD		142	
intrusion panel		158, 159	
IntuiKey keyboard		153	
IP address			
change		106, 123, 137, 220	
duplicates		105	
iPad		157	
iPhone		157	
IQN mapping		188	
iSCSI device		188	
iSCSI storage pool		166, 184	
iSCSI storage system		184	
K			
KBD Universal XF keyboard		51, 124, 134	
L			
language		346	
Configuration Client		120	
Operator Client		313	
large LUN		177, 181, 186, 191, 192	
Large LUNs		177	
LDAP group		117, 337	
LDAP user		313	
LDAP user groups		117, 313, 337	
licensing			
Bosch Video Management System		76	
Config Wizard		73	
Stratus server		76	
link to map		257	
Logbook database		120	
connection string		120	
logging		170, 304, 306	
logging ONVIF events		354	
Logical Tree		248, 299	
LUNS			
larger than 2 TB		177	
M			
malfunction relay		263	
Management Server		20, 23, 328	
manual recording		43, 295, 307	
map			
blinking hot spots		290, 309	
map link		257	
map viewport		258	
Map-based tracking assistant		263	
maps		246	
menu commands		102	
MIC IP 7000		345	
Mobile Video Service		64, 157	
monitor group		143, 144, 295, 300	
add		143	
initial camera		144	
OSD		144	
quad view		144	
single view		144	
startup camera		144	
MOV		319	
move device		191, 200, 218	
multi monitor mode		322	
multicast		197	
multi-select		248, 249	
N			
network address			
change		137, 220	
network monitoring device		123	
new DiBos devices		130, 131	
no password		93	
NVR		20	
O			
offline		313, 328	
Offline Mode		327	
online application Help		14	

ONVIF logging	354	redundant recording	28
ONVIF Media profile	273	Redundant VRM	28, 125, 173
OPC Server	346	refresh states	102, 106, 107, 108
Operator Client	16, 248	Region of Interest	273, 286, 316
P		relay	
panoramic camera		malfunction	263
viewing modes	44	Release Notes	20
password	141, 210, 217	Remote export	44
password change	141, 172, 210, 217, 313	remove prepositions	284
password missing	93	remove user	313
peripheral device	123	replace content	249
permissions	246, 248	resource files	249
Person identification		import	249
Add cameras to person identification device	163	ROI	273, 286, 316
Adding a person identification device	162	S	
Person identification device	161	scan	
point		across subnets	120
bypass	321	encoders	125
pool		in subnets	120
change	218	live only encoders	125
move device	191, 200, 218	local storage encoders	125
VRM	172, 218	VRM	125
pooling	166, 184	scan for conflicting IP addresses	105
post-alarm time	282	Secondary Failover VRM	172
post-event time	274, 281, 282	secondary recording	183, 287
pre-alarm time	282	Secondary VRM	28, 125, 168
pre-event time	274, 281, 282	sequence	256
previous configuration	94	Server ID	79
Primary Failover VRM	172	Server initiator name	169
Primary VRM	28, 125, 168	Server List	
printing the Help	15	add columns	86, 127
profile	278	delete columns	86, 127
protect alarm recording	308	Server Lookup	127
PTZ blocking	316, 322, 339	Server Network	205, 206, 207
PTZ camera	284, 285	silence bells	321
Allegiant	274	SNMP settings	114
PTZ control		SNMP traps	
blocking	316, 322, 339	get	114
push-to-talk	320	send	114
Q		sort order	
quad view	144	alarms	295
R		states	102, 106, 107, 108
RAM recording	282	status	96
recording mode		Stratus server	
automatic	176	licensing	76
failover	176	stream	273, 283
Recording preferences	223	switch off alarm sirens	321
recording quality	278		
Recording Table	271		

synchronization	84	W	
synchronize		Web client	157
VRM configuration	175	WLAN	157
system requirements	20	workstation	120
T			
Target data rate	280		
time server	84		
time synchronization	84		
time zone	205, 206		
too many Allegiant cameras	348		
transcoding service	157		
trigger text data recording	308		
U			
UHD cameras	136		
Unauthorized person			
Unauthorized person detected	310		
unreliable network	157		
update			
device capabilities	82, 212		
user			
delete	313		
remove	313		
user event button	304		
user groups	311, 313		
V			
verify authenticity	215		
video analytics	160		
Video Streaming Gateway	123		
VIDEOJET 7000 connect	345		
viewing modes of panoramic camera	44		
VIP X1600 XFM4	281		
VIP XD	51		
half-duplex mode	142		
interface settings	142		
quad view	144		
virtual input	123		
VRM			
add	167		
add pool	172		
Failover	28, 125, 172		
pool	172, 218		
Primary	28, 125, 168		
Primary Failover	172		
Redundant	28, 125, 173		
Secondary	28, 125, 168		
Secondary Failover	172		
VRM 3.50	175		
VRM storage pool	166, 184		

Bosch Security Systems B.V.

Torenallee 49

5617 BA Eindhoven

Netherlands

www.boschsecurity.com

© Bosch Security Systems B.V., 2023

Building solutions for a better life.

202303211456