

BVMS

Table of contents

1	Using the Help	8
1.1	<i>Finding information</i>	8
1.2	<i>Printing the Help</i>	9
2	Safety message explanation	10
3	Introduction	11
3.1	<i>BVMS editions</i>	12
4	System overview	14
4.1	<i>Hardware requirements</i>	15
4.2	<i>Software requirements</i>	15
4.3	<i>License requirements</i>	15
5	Concepts	16
5.1	<i>BVMS design concepts</i>	16
5.1.1	<i>Single Management Server System</i>	16
5.1.2	<i>Enterprise System</i>	17
5.1.3	<i>Server Lookup</i>	18
5.1.4	<i>Unmanaged site</i>	19
5.2	<i>Recording</i>	20
5.2.1	<i>Automated Network Replenishment (ANR)</i>	21
5.2.2	<i>Overview of the storage related events</i>	22
5.3	<i>Alarm handling</i>	23
5.4	<i>Inactivity logoff</i>	25
5.5	<i>Version independent Operator Client</i>	25
5.5.1	<i>Working with Compatibility Mode</i>	25
5.6	<i>Viewing modes of a panoramic camera</i>	26
5.6.1	<i>360° panoramic camera - floor- or ceiling mounted</i>	26
5.6.2	<i>180° panoramic camera - floor- or ceiling mounted</i>	28
5.6.3	<i>360° panoramic camera - wall mounted</i>	29
5.6.4	<i>180° panoramic camera - wall mounted</i>	30
5.6.5	<i>Cropped view on a panoramic camera</i>	31
5.7	<i>SSH Tunneling</i>	32
6	Use latest software	33
7	Getting started	34
7.1	<i>Starting Operator Client</i>	34
7.2	<i>Starting Operator Client with command line parameters</i>	35
7.3	<i>Accepting a new configuration</i>	35
7.4	<i>Accessing the system</i>	36
7.5	<i>Using Server Lookup</i>	36
8	Displaying camera images	37
8.1	<i>Selecting a time zone</i>	37
8.2	<i>Displaying a camera in an Image pane</i>	38
8.3	<i>Displaying a panoramic camera</i>	38
8.4	<i>Switching the viewing mode of panoramic camera</i>	39
8.5	<i>Displaying a dual thermal/optical camera</i>	39
8.6	<i>Displaying cameras from multiple Management Servers</i>	40
8.7	<i>Finding an item in the Logical Tree</i>	40
8.8	<i>Changing the number of Image pane rows</i>	40
8.9	<i>Arranging and resizing Image panes</i>	41
8.10	<i>Displaying the Alarm Image window</i>	42

8.11	<i>Starting manual recording</i>	42
8.12	<i>Starting a pre-configured camera sequence</i>	42
8.13	<i>Starting an automatic camera sequence</i>	43
8.14	<i>Using one channel audio mode</i>	44
8.15	<i>Using multichannel audio mode</i>	44
8.16	<i>Using digital zoom</i>	45
8.17	<i>Saving a single image pane</i>	45
8.18	<i>Printing a single image pane</i>	46
8.19	<i>Switching to full-screen mode</i>	46
8.20	<i>Displaying or hiding the Image pane bars</i>	46
8.21	<i>Displaying information on a camera</i>	46
8.22	<i>Enabling video content analysis (VCA)</i>	47
8.23	<i>Showing video content analysis (VCA) rules</i>	47
8.24	<i>Starting instant playback</i>	47
8.25	<i>Assigning a camera to a monitor</i>	48
8.26	<i>Using audio mode</i>	48
8.27	<i>Using the Intercom functionality</i>	49
8.28	<i>Locking the control of a PTZ camera</i>	50
8.29	<i>Updating the reference image</i>	50
8.30	<i>Displaying a monitor group</i>	51
8.31	<i>Selecting live stream for display</i>	51
8.32	<i>Displaying video via low bandwidth</i>	52
8.33	<i>Using TCP for reliable connection</i>	53
8.34	<i>Connecting to an unmanaged site</i>	54
8.35	<i>Displaying a video analytics alarm</i>	55
8.36	<i>Displaying Intelligent Insights widgets</i>	55
9	Using PTZ cameras	56
9.1	<i>Controlling PTZ cameras</i>	56
9.2	<i>Using in-window control of a PTZ camera</i>	56
9.3	<i>Using the ROI function</i>	57
9.4	<i>Using Intelligent Tracking</i>	57
10	Using maps, the global map and map viewports	59
10.1	<i>Displaying a site map</i>	59
10.2	<i>Displaying a map viewport</i>	60
10.3	<i>Using the Map-based tracking assistant</i>	60
11	Using favorites and bookmarks	63
11.1	<i>Adding items to the favorites tree</i>	63
11.2	<i>Creating/editing views</i>	64
11.3	<i>Exporting favorites settings</i>	65
11.4	<i>Importing favorites settings</i>	66
11.5	<i>Adding a bookmark</i>	66
11.6	<i>Editing a bookmark</i>	67
11.7	<i>Loading a bookmark</i>	67
11.8	<i>Exporting video of bookmarks</i>	67
11.8.1	<i>Export video of bookmark dialog box</i>	68
11.8.2	<i>Export video of multiple bookmarks dialog box</i>	70
11.9	<i>Exporting bookmark settings</i>	71
11.10	<i>Importing bookmark settings</i>	71
12	Managing recorded videos	73

12.1	<i>Selecting a time zone</i>	73
12.2	<i>Finding recorded video</i>	74
12.2.1	<i>Video Search Results window</i>	75
12.3	<i>Playing recorded videos</i>	75
12.4	<i>Using the timeline</i>	75
12.5	<i>Changing the playback speed</i>	76
12.6	<i>Restricting or unrestricting video</i>	76
12.7	<i>Protecting or unprotecting video</i>	77
12.8	<i>Deleting video data</i>	78
12.9	<i>Verifying the authenticity of video data</i>	78
12.9.1	<i>Authenticity verification result dialog box</i>	79
12.10	<i>Exporting video data</i>	80
12.10.1	<i>Exporting a time period</i>	82
12.10.2	<i>Exporting a single search entry</i>	82
12.10.3	<i>Exporting into a single file</i>	83
12.10.4	<i>Providing a password for export</i>	84
12.10.5	<i>Export Video dialog box</i>	84
12.10.6	<i>Export dialog box</i>	86
12.11	<i>Loading exported video</i>	86
12.12	<i>Enabling video content analysis (VCA)</i>	87
12.13	<i>Performing a Forensic Search</i>	87
12.14	<i>Forensic Search Results window</i>	90
12.15	<i>Finding logbook entries</i>	90
12.15.1	<i>Finding logons to an unmanaged site</i>	90
12.15.2	<i>Please select a Server</i>	91
12.15.3	<i>Select Search Parameters dialog box</i>	91
12.15.4	<i>Event Selection dialog box</i>	93
12.15.5	<i>Device Selection dialog box</i>	93
12.15.6	<i>Search Conditions dialog box</i>	93
12.15.7	<i>Logbook Results: dialog box</i>	93
12.16	<i>Displaying text data</i>	94
12.17	<i>Searching for text data</i>	95
12.18	<i>Searching for text data in logbook entries</i>	96
12.19	<i>Erasing text data from logbook entries</i>	96
12.20	<i>Displaying video via low bandwidth</i>	97
12.21	<i>Switching the recording source</i>	99
12.22	<i>Unsynchronizing image panes</i>	99
12.23	<i>Connecting to an unmanaged site</i>	99
13	Handling events and alarms	101
13.1	<i>Accepting an alarm</i>	101
13.2	<i>Adding comments to an alarm</i>	102
13.3	<i>Clearing an alarm</i>	102
13.4	<i>Customizing the Alarm List window</i>	103
13.5	<i>Displaying the Live Image window</i>	103
13.6	<i>Switching alarm displays of alarm image window</i>	103
13.7	<i>Starting a workflow</i>	104
13.8	<i>Un-accepting an alarm</i>	104
13.9	<i>Triggering a user event</i>	105
13.10	<i>Alarm List window</i>	105

14	Managing Person Identification alarms	107
14.1	<i>Managing persons for a Person Identification alarm</i>	107
15	Controlling intrusion panel functions	109
15.1	<i>Switching off alarm sirens</i>	109
15.2	<i>Operating doors</i>	109
15.3	<i>Bypassing a point</i>	109
15.3.1	<i>Arming an area</i>	110
16	Controlling access control functions	111
16.1	<i>Granting and denying access</i>	111
16.2	<i>Operating doors</i>	111
17	Using a CCTV keyboard	113
17.1	<i>Using KBD Universal XF keyboard</i>	113
17.1.1	<i>KBD Universal XF keyboard user interface</i>	113
17.2	<i>Bosch IntuiKey keyboard user interface</i>	115
17.2.1	<i>Status display</i>	116
17.3	<i>Using a Bosch IntuiKey keyboard connected to a workstation</i>	116
17.3.1	<i>Starting the IntuiKey keyboard</i>	117
17.3.2	<i>Entering operation modes</i>	117
17.3.3	<i>Displaying cameras</i>	117
17.3.4	<i>Using the joystick of IntuiKey keyboard</i>	118
17.3.5	<i>Using softkeys of IntuiKey keyboard</i>	119
17.4	<i>Using a Bosch IntuiKey keyboard connected to a decoder</i>	121
17.4.1	<i>Starting the keyboard</i>	121
17.4.2	<i>Displaying cameras</i>	121
17.4.3	<i>Using the joystick</i>	122
17.4.4	<i>Using softkeys</i>	122
18	User interface	123
18.1	<i>Live Mode</i>	123
18.2	<i>Playback Mode</i>	125
18.3	<i>Threat level mode</i>	127
18.4	<i>Alarm display</i>	128
18.5	<i>Map-based tracking assistant display</i>	130
18.6	<i>Icons used</i>	132
18.7	<i>Menu commands</i>	137
18.8	<i>Options dialog box</i>	139
18.8.1	<i>Control tab</i>	140
18.8.2	<i>Display tab</i>	140
18.8.3	<i>Audio tab</i>	141
18.8.4	<i>Transcoding tab</i>	141
18.9	<i>Logical Tree window</i>	142
18.10	<i>Favorites Tree window</i>	142
18.11	<i>Bookmarks window</i>	143
18.12	<i>Image window</i>	143
18.13	<i>Image pane</i>	144
18.14	<i>Search box</i>	145
18.15	<i>Exports window</i>	145
18.16	<i>Map window</i>	146
18.17	<i>PTZ Control window</i>	146
18.18	<i>Timeline window</i>	147

19	Keyboard shortcuts	150
19.1	<i>General controls</i>	150
19.2	<i>Playback controls</i>	150
19.3	<i>Image window controls</i>	150
20	Troubleshooting	151
20.1	<i>Reestablishing the connection to a Bosch IntuiKey keyboard</i>	151
	Glossary	152
	Index	157

1 Using the Help



Notice!

This document describes some functions that are not available for BVMS Viewer. For detailed information about the different BVMS editions refer to www.boschsecurity.com and the BVMS Quick Selection Guide: [BVMS Quick Selection Guide](#).

To find out more about how to do something in BVMS, access the online Help using any of the following methods.

To use the Contents, Index, or Search:

- ▶ On the **Help** menu, click **Display help**. Use the buttons and links to navigate.

To get help on a window or dialog:

- ▶ On the toolbar, click .

OR

- ▶ Press F1 for help on any program window or dialog.

1.1 Finding information

You can find information in the Help in several ways.

To find information in the Online Help:

1. On the **Help** menu, click **Help**.
2. If the left-hand pane is not visible, click the **Show** button.
3. In the Help window, do the following:

Click:	To:
Contents	Display the table of contents for the Online Help. Click each book to display pages that link to topics, and click each page to display the corresponding topic in the right-hand pane.
Index	Search for specific words or phrases or select from a list of index keywords. Double-click the keyword to display the corresponding topic in the right-hand pane.
Search	Locate words or phrases within the content of your topics. Type the word or phrase in the text field, press ENTER, and select the topic you want from the list of topics.

Texts of the user interface are marked **bold**.

- ▶ The arrow invites you to click on the underlined text or to click an item in the application.

Related Topics

- ▶ Click to display a topic with information on the application window you currently use. This topic provides information on the application window controls.

Concepts, page 16 provides background information on selected issues.



Notice!

This symbol indicates a potential risk of property damage or data loss.

1.2 Printing the Help

While using the Online Help, you can print topics and information right from the browser window.

To print a Help topic:

1. Right-click in the right pane and select **Print**.
The **Print** dialog box opens.
2. Click **Print**.
⇒ The topic is printed to the specified printer.

2 Safety message explanation

In this manual, the following symbols and notations are used to draw attention to special situations:

**Danger!**

High risk: This symbol indicates an imminently hazardous situation such as “Dangerous Voltage” inside the product. If not avoided, this will result in an electrical shock, serious bodily injury, or death.

**Caution!**

Medium risk: Indicates a potentially hazardous situation. If not avoided, this may result in minor or moderate injury. Alerts the user to important instructions accompanying the unit.

**Caution!**

Low risk: Indicates a potentially hazardous situation. If not avoided, this may result in property damage or risk of damage to the unit.

**Notice!**

This symbol indicates information or a company policy that relates directly or indirectly to the safety of personnel or protection of property.

3 Introduction

Click the link to access the Open Source Software licenses used by BVMS and the Mobile App:

<http://www.boschsecurity.com/oss/>



Covered by one or more claims of the patents listed at patentlist.hevcadvance.com.

This manual guides you through the basic steps of the operation with BVMS.

For detailed help and step-by-step instructions read the User Manual or use the Online Help.

BVMS

BVMS Export Player

BVMS Export Player displays exported recordings.

BVMS Viewer

The BVMS Viewer is an IP video security application for live viewing and playback video of Bosch network attached cameras and recorders. The software package consists of an Operator Client for live viewing and playback of video and a Configuration Client. The BVMS Viewer supports the current Bosch IP video product portfolio as well as legacy Bosch video devices.

Click the link to access the Open Source Software licenses used by BVMS Viewer:





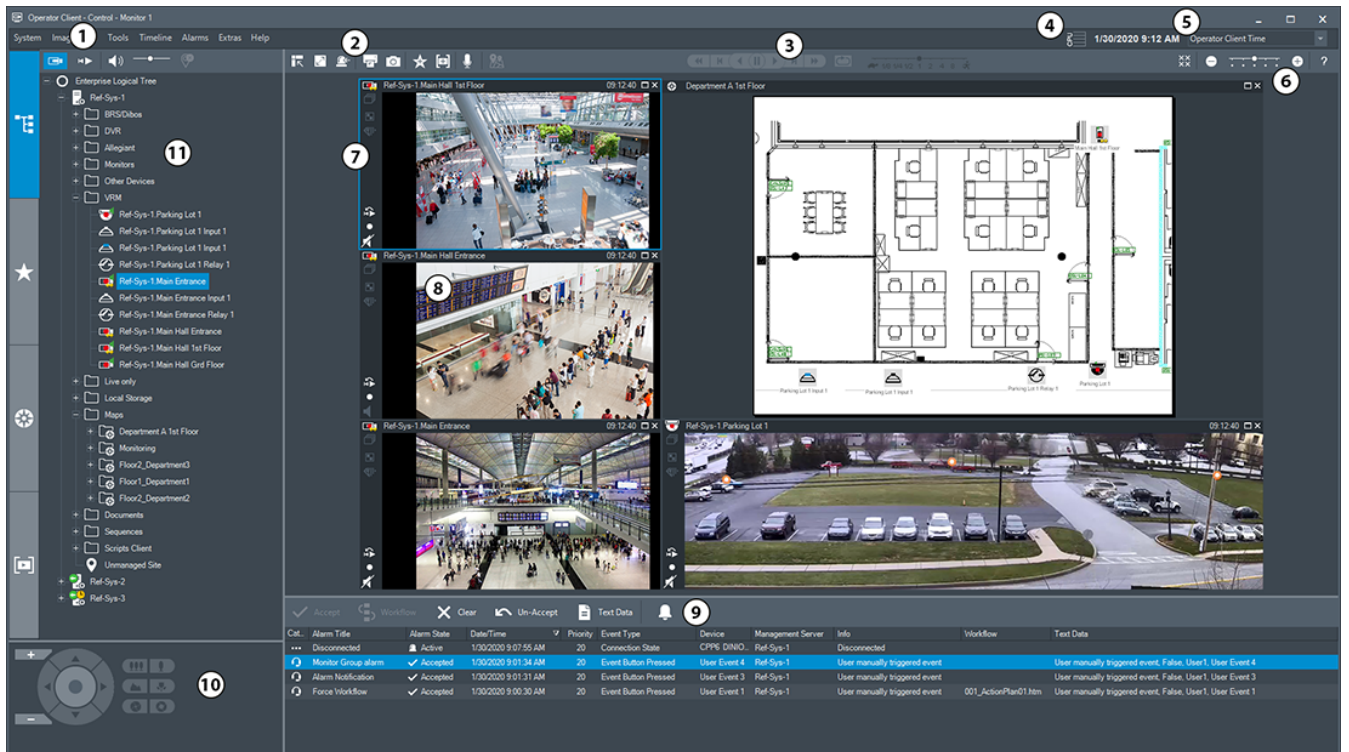

<http://www.boschsecurity.com/oss/>

BVMS Configuration Client

BVMS Operator Client



1	Menu bar	Allows you to select a menu command.
---	----------	--------------------------------------

2	Toolbar	Displays the available buttons. Point to an icon to display a tooltip.
3	Playback controls	Allows you to control instant playback or a camera sequence or alarm sequence.
4	Performance meter	Displays the CPU usage.
5	Time zone selector	Select an entry for the time zone to be displayed in most time related fields. Only available if at least one Management Server or unmanaged site in the Logical Tree is located in another time zone as your Operator Client.
6	Controls for Image panes	Allows you to select the required number of Image panes and to close all Image panes.
7	Image window	Displays the Image panes. Allows you to arrange the Image panes.
8	Image pane	Displays a camera, a map, an image, a document (HTML file).
9	 Alarm List window	Displays all alarms that the system generates. Allows you to accept or clear an alarm or to start a workflow, for example, by sending an E-mail to a maintenance person. The Alarm List is not being displayed, when the connection to the Management Server is lost.
10	 PTZ Control window	Allows you to control a PTZ camera.
11	 Logical tree window	Displays the devices your user group has access to. Allows you to select a device for assigning it to an Image pane.
	 Favorites tree window	Allows you to organize the devices of the Logical Tree as required.
	 Bookmarks window	Allows to manage bookmarks.
	 Map window	Displays a site map. Allows you to drag the map to display a particular section of the map. If activated, a map is displayed automatically for each camera displayed in an Image pane. In this case, the camera must be configured on a map.

3.1

BVMS editions

The different BVMS editions offer you full scalability, so you can expand your video surveillance system according to your needs.

The following editions of BVMS are available:

- BVMS Professional
- BVMS Enterprise
- BVMS Plus
- BVMS Lite
- BVMS Viewer

BVMS Viewer and BVMS Professional are Software Only products. You can not use them on Bosch DIVAR IP devices.

You can use BVMS Lite and BVMS Plus on Bosch DIVAR IP devices or as Software Only products on any other hardware.

For detailed information about the different BVMS editions refer to www.boschsecurity.com and the BVMS Quick Selection Guide:

[BVMS Quick Selection Guide.](#)

4 System overview



Notice!

This document describes some functions that are not available for BVMS Viewer.

For detailed information about the different BVMS editions refer to www.boschsecurity.com and the BVMS Quick Selection Guide: [BVMS Quick Selection Guide](#).

If you plan to install and configure BVMS, participate in a system training on BVMS. Refer to the Release Notes of the current BVMS version for supported versions of firmware and hardware and other important information.

See data sheets on Bosch workstations and servers for information on computers where BVMS can be installed.

The BVMS software modules can optionally be installed on one PC.

Important components

Component	Description
Management Server (selectable in Setup)	Stream management, alarm management, priority management, Management logbook, user management, device state management. Additional Enterprise System license: Managing Enterprise User Groups and Enterprise Accounts.
Config Wizard	Easy and fast setup of a recording system.
Configuration Client (selectable in Setup)	System configuration and administration for Operator Client.
Operator Client (selectable in Setup)	Live monitoring, storage retrieval and playback, alarm and accessing multiple Management Server computers simultaneously.
Video Recording Manager (selectable in Setup)	Distributing storage capacities on iSCSI devices to the encoders, while handling load balancing between multiple iSCSI devices. Streaming playback video and audio data from iSCSI to Operator Clients.
Mobile Video Service (selectable in Setup)	Provides a transcoding service that transcodes the live and recorded video stream from a camera configured in BVMS to the available network bandwidth. This service enables video clients like an iPhone or a Web client to receive transcoded streams, for example for unreliable network connections with limited bandwidth.
Web Client	You can access live and playback videos via Web browser.
Mobile App	You can use the Mobile App on iPhone or iPad to access live and playback video.
Bosch Video Streaming Gateway (selectable in Setup)	Provides the integration of 3rd party cameras, e.g. in low-bandwidth networks.
Cameo SDK (selectable in Setup)	The Cameo SDK is used to embed BVMS live and playback Image panes to your external third-party application. The Image panes follow the BVMS based user

Component	Description
	permissions. The Cameo SDK provides a subset of the BVMS Operator Client functionalities that enables you to create applications similar to the Operator Client.
Client Enterprise SDK	The Client Enterprise SDK is meant to control and monitor the behaviour of Operator Client of an Enterprise System by external applications. The SDK allows to browse devices that are accessible by the running, connected Operator Client and to control some UI functionalities.
Client SDK / Server SDK	The Server SDK is used to control and monitor the Management Server by scripts and external applications. You can use those interfaces with a valid administrator account. The Client SDK is used to control and monitor the Operator Client by external applications and scripts (part of the related server configuration).

4.1 Hardware requirements

See the data sheet for BVMS. Data sheets for platform PCs are also available.

4.2 Software requirements

You can not install the BVMS Viewer where any other BVMS component is installed.

See the data sheet for BVMS.

4.3 License requirements

See the data sheet for BVMS for the available licenses.

5 Concepts

**Notice!**

BVMS Viewer offers only basic features. Advanced features are included in BVMS Professional. For detailed information about the different BVMS editions refer to www.boschsecurity.com and the BVMS Quick Selection Guide: [BVMS Quick Selection Guide](#).

This chapter provides background information on selected issues.

5.1 BVMS design concepts

Single Management Server System, page 16

A single BVMS Management Server System provides management, monitoring and control of up to 2000 cameras/encoders.

Enterprise System, page 17

An Enterprise Management Server provides simultaneous access to multiple Management Servers. The Enterprise System allows full access to events and alarms from multiple subsystems.

Server Lookup, page 18

The Server Lookup feature provides a list of available BVMS Management Servers to the BVMS Operator Client. The Operator can select a server out of the list of available server. Connected to the Management Server the Client has full access to the Management Server.

Unmanaged site, page 19

Devices can be grouped to unmanaged sites. Devices under unmanaged sites are not monitored by the Management Server. The Management Server provides a list of unmanaged sites to the Operator Client. The Operator can connect on demand to the site and gets access to live video data and recorded video data. Event and alarm handling is not available in the unmanaged site concept.

5.1.1 Single Management Server System

- A single BVMS Management Server can manage up to 2000 channels.
- A BVMS Management Server provides management, monitoring, and control of the entire system.
- The BVMS Operator Client is connected to the Management Server and receives events and alarms from the BVMS Management Server and shows live and playback.
- In most cases all devices are in one local area network with a high bandwidth and a low latency.

Responsibilities:

- Configuring data
- Event log (logbook)
- User profiles
- User priorities
- Licensing
- Event- and alarm-management



	Live, playback, events, alarms
	Management Server
	Operator Client / Configuration Client
	Cameras
	VRM
	iSCSI
	Other devices

5.1.2 Enterprise System

- The target of a BVMS Enterprise System is to enable a user of an Operator Client to simultaneously access multiple Management Servers (subsystems).
- Clients connected to an Enterprise Server have full access to all cameras and recordings from the subsystems.
- Clients connected to an Enterprise Server have full real time awareness of events and alarms of all subsystems.
- Typical application areas:
 - Metros
 - Airports

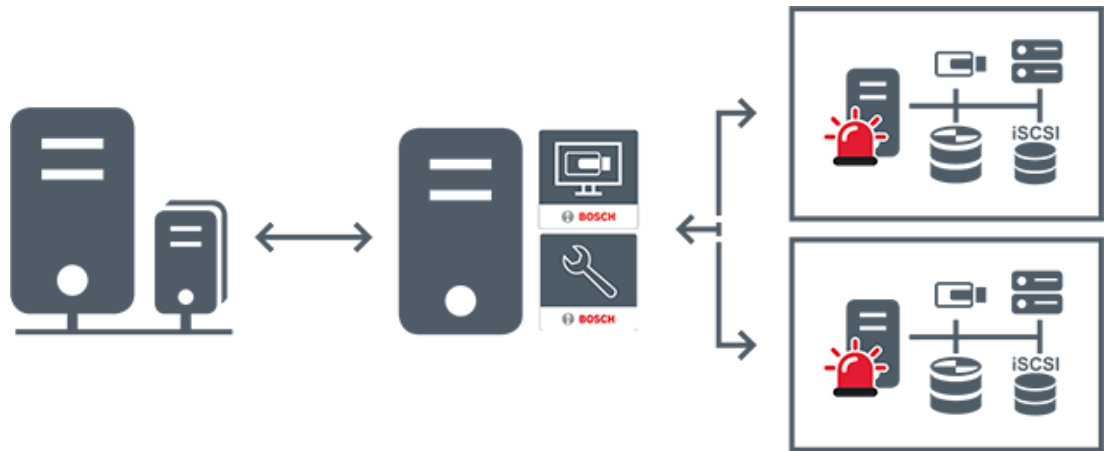

	Live, playback, events, alarms
	BVMS Enterprise Management Server
	BVMS Operator Client / Configuration Client
	BVMS Subsystem

Refer to

- *Accessing the system, page 36*

5.1.3

Server Lookup

- The BVMS Server Lookup feature allows Operators to connect to a BVMS Management Server out of a provided list of servers.
- A single user of Configuration Client or Operator Client can connect to multiple system access points sequentially.
- System access points can be Management Server or Enterprise Management Server.
- Server Lookup uses dedicated Management Server to host the Server List.
- Server Lookup and Management Server or Enterprise Management Server functionally can be run on one machine.
- Server Lookup supports you in locating system access points by their names or descriptions.
- Once connected to the Management Server the Operator Client receives events and alarms from the BVMS Management Server and shows live and playback

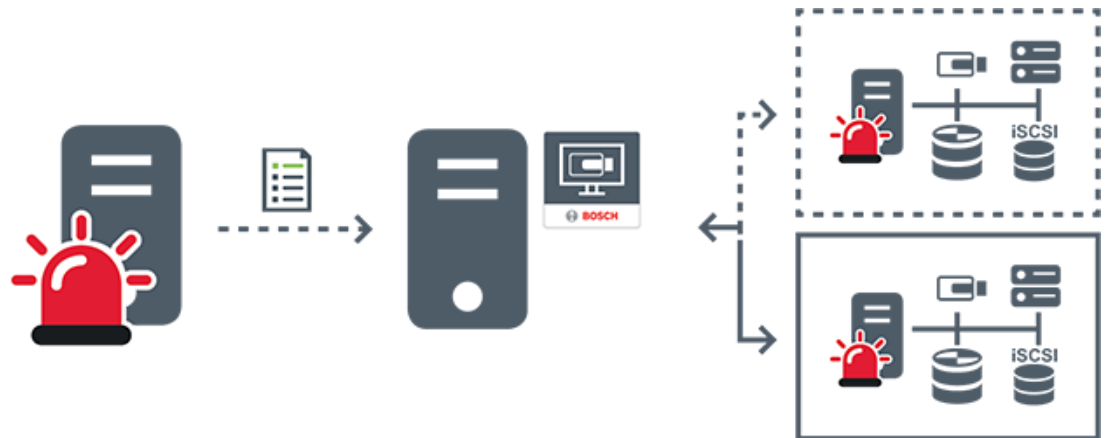

	On demand live, playback, events, alarms - connected
	On demand live, playback, events, alarms - not connected
	Management Server
	Server list
	Operator Client
	Connected BVMS from server list
	Not connected BVMS from server list

Refer to

- *Using Server Lookup, page 36*

5.1.4

Unmanaged site

- A system design option in BVMS with a large number of small subsystems.
- It allows to configure up to 9999 locations in one BVMS Management Server
- Operators can access live and recorded video data from up to 20 sites simultaneously.
- For an easy navigation sites can be grouped in folders or can be placed on maps. Predefined username and password allow operators to quickly connect to a site .

The unmanaged site concept supports IP based BVMS system as well as analog DVR solutions:

- Bosch DIVAR AN 3000 / 5000 analog recorders
- DIVAR hybrid recorders
- DIVAR network recorders
- DIP 3000/7000 units IP based recording
- Single BVMS Management Server System

Adding a site for central monitoring only requires a license per site and is independent of the number of channels in the site.

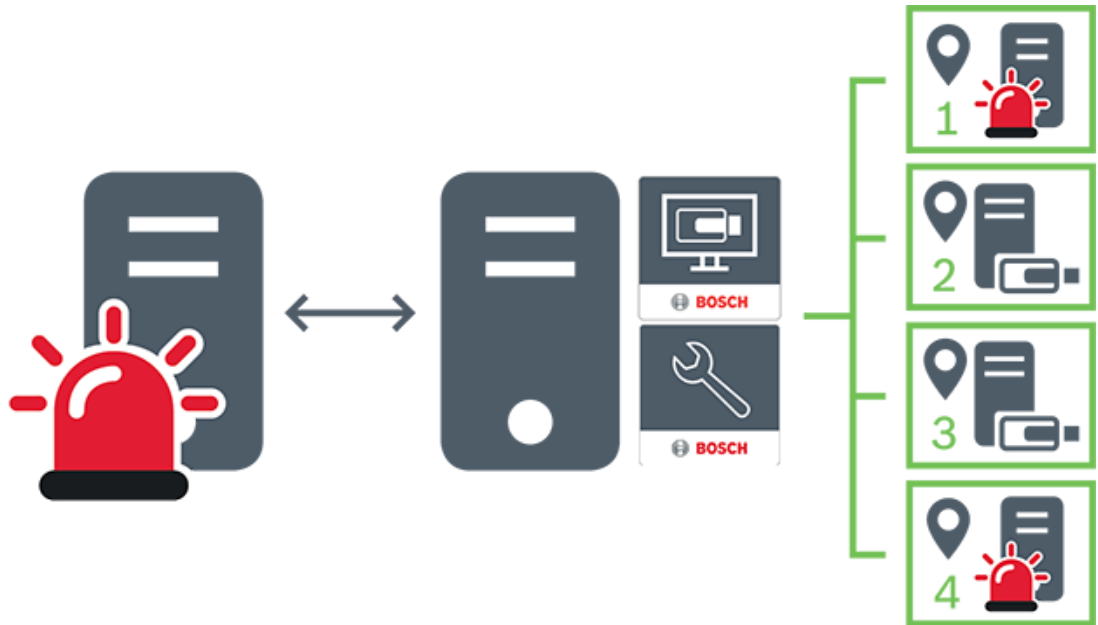

	Live, playback, events, alarms
	On demand live and playback video traffic
	Management Server
	Operator Client / Configuration Client
	site
	DVR

5.2 Recording

This chapter explains the different recording and replay related functions in the system.

5.2.1 Automated Network Replenishment (ANR)



Notice!

BVMS Viewer offers only basic features. Advanced features are included in BVMS Professional. For detailed information about the different BVMS editions refer to www.boschsecurity.com and the BVMS Quick Selection Guide: [BVMS Quick Selection Guide](#).

Intended use

When a failure of the network or the central storage occurs, the ANR function ensures that the encoder transmits the locally buffered recording of the missing time period to the central storage after the failure is fixed. The following graphic shows the transmission of video data after a network or storage failure is fixed.

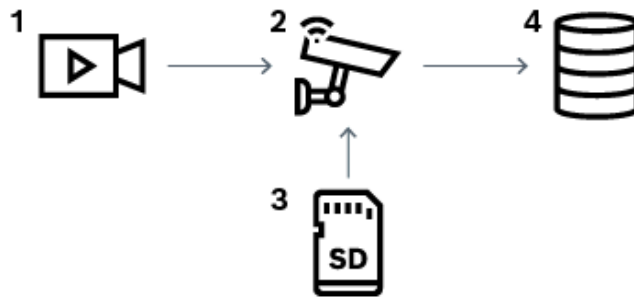

1	Video
2	Encoder, IP network
3	SD card (ring buffer)
4	iSCSI target (central storage)

Example: Work around network failure

If the network fails unexpectedly, the ANR function completes the central storage with the locally buffered recording when the network is available again.

Example: Store video data when network is not available

A subway has no network connection to the central storage when located between stations. Only during regular stops the buffered recording can be transmitted to the central storage. Ensure that the time period that is required for transferring the buffered recording, does not exceed the time period of a stop.

Example: ANR for alarm recording

The pre-alarm recording is stored locally. Only in case of an alarm, this pre-alarm recording is transmitted to the central storage. If no alarm occurs, the obsolete pre-alarm recording is not transmitted to the central storage and, hence, does not burden the network.

Limitations



Notice!

You cannot use playback from the local storage media when the passwords for `user` and `live` are set on the encoder. Remove the passwords if required.

The ANR function only works with VRM recording.

The ANR function does not work with an encoder for which a secure connection for live display is configured.

You must have configured the storage media of an encoder to use the ANR function.

The encoder for which you configure the ANR function, must have firmware version 5.90 or later. Not all encoder types support the ANR function.

You cannot use the ANR function with dual recording.

Your iSCSI storage system must be properly configured.

The following list contains the possible reasons if you cannot configure the ANR function:

- Encoder is not reachable (wrong IP address, network failure, etc.).
- Storage media of the encoder not available or read-only.
- Wrong firmware version.
- Encoder type does not support the ANR function.
- Dual recording is active.

5.2.2

Overview of the storage related events

This chapter describes the different storage related events.

Buffer Storage State

When a failure of the network or the central storage occurs, the ANR function ensures that the encoder transmits the locally buffered recording of the missing time period to the central storage after the failure is fixed.

The buffer storage states are:

- **Storage State Unknown**
- **Storage State OK**
- **Storage State Critical Buffer Fill Level**
- **Storage State Failure**

Buffer Storage Overflow

This event indicates that the storage buffer is already full and the recording is not transmitted to the central storage anymore.

Storage State / Secondary Storage State

The **Storage State** indicates the status of the connection between a camera and the central storage. The **Storage State Failure** event is triggered if the camera loses the connection to the central storage. If the disconnection only lasts a short moment, this event does not necessarily indicate that video data is lost.

The storage states are:

- **Storage State Unknown**
- **Storage State OK**
- **Storage State Failure**

Recording monitor state / Secondary recording monitor state

This event indicates a recording monitoring. As long as the camera can buffer recording in the RAM, no alarm is triggered. The **Recording monitor state recording loss** event is only triggered if within the last two minutes video data can no longer be buffered in the RAM and is lost. The event also indicates the time period when video data was lost.

The recording monitor states are:

- **Recording monitor state unknown**
- **Recording monitor state ok**
- **Recording monitor state recording loss**

Refer to

- *Automated Network Replenishment (ANR), page 21*

5.3

Alarm handling

Alarms can be individually configured to be handled by one or more user groups. When an alarm occurs, it appears in the Alarm List of all users in the user groups configured to receive that alarm. When any one of these users starts to work on the alarm, it disappears from the Alarm List of all other users.

Alarms are displayed on a workstation's alarm monitor. This behavior is described in the following paragraphs.

Alarm flow

1. An alarm occurs in the system.
2. Alarm notifications appear in the Alarm Lists of all users configured for this alarm. Alarm video is immediately displayed on configured monitors. If it is an automatically displayed alarm (auto pop-up), the alarm video is also automatically displayed on the Operator Client workstation's alarm monitors.
If the alarm is configured as an auto-clear alarm, the alarm is removed from the Alarm List after the auto-clear time (configured in the Configuration Client).
On monitors, any quad views from VIP XDs are temporarily replaced by full-screen displays.
3. One of the users accepts the alarm. The alarm video is then displayed on this user's workstation (if it is not already displayed via auto pop-up). The alarm is removed from all other Alarm Lists and alarm video displays.
4. The user who accepted the alarm invokes a workflow that can include reading an action plan and entering comments. This step is optional - requirements for workflow can be configured by the administrator.
5. Finally, the user clears the alarm. This removes the alarm from his Alarm List and alarm display.
On a monitor group, the monitors return to the cameras that were displayed before the alarm occurred.

Alarm Image window

1. To display alarm video, the Alarm Image window replaces the Live or Playback Image window on the monitor that has been configured for alarm display.
2. Each alarm gets a row of Image panes. Up to 5 Image panes can be associated with each alarm. These Image panes can display live video, playback video, or maps.
On a monitor group, each alarm can call up cameras on a row of monitors. The number of cameras in the row is limited by the number of columns in the monitor group. Monitors in the row that are not used for alarm video can be configured to either continue with their current display or to display a blank screen.

3. Higher priority alarms are displayed above lower priority alarms on both monitor rows and the Operator Client workstation display alarm rows.
4. If the Alarm image window is completely full of Alarm image rows and an additional alarm must be displayed, the lowest priority alarms "stack up" in the bottom row of the Alarm image window. You can step through the stacked alarms with the controls at the left side of the alarm row.
You can step through the alarm stacks on monitor groups with control buttons in the **Monitors** window of the Operator Client workstation display. Monitors in alarm are indicated by red icons with blinking "LEDs".
The alarm title, time, and date can be optionally be displayed on all monitors, or only the first monitor in the alarm row.
5. For equal priority alarms, the administrator can configure the order behavior:
 - Last-in-First-out (LIFO) mode: in this configuration, new alarms are inserted *above* older alarms of the same priority.
 - First-in-First-out (FIFO) mode; in this configuration, new alarms are inserted *below* older alarms of the same priority.
6. An alarm's Image row can appear in the Alarm Image window in one of two ways:
 - When it is generated (auto pop-up). This occurs when the alarm priority is higher than display priority.
 - When the alarm is accepted. This occurs when the alarm priority is lower than display priority.

Auto pop-up alarms

Alarms can be configured to automatically display (pop up) in the Alarm Image window, based on the alarm priority. Each user group's live and playback displays are also assigned priorities. When alarms are received with priority higher than that of the user's display, the alarm automatically displays its alarm row in the Alarm Image window. If the Alarm Image window is not currently displayed, it automatically replaces the Live or Playback Image window on the alarm-enabled monitor.

Although auto pop-up alarms are displayed in the Alarm Image window, they are not automatically accepted. They can be displayed on multiple users' displays simultaneously. When a user accepts an auto pop-up alarm, it is removed from all other users Alarm Lists and alarm displays.

Alarm handling in case of shutdown

On a server shutdown all active alarms are preserved. The alarms are restored and reappear in the **Alarm List** window, when the system restarts.

Alarms in the state **Accepted** or **Workflow** are automatically set back to the state **Active** when the system restarts. Comments entered for alarms in the state **Workflow** are preserved.



Notice!

The alarm data is automatically saved every minute, so the maximum data loss is the data accumulated in one minute.

Refer to

- *Alarm display, page 128*
- *Handling events and alarms, page 101*

5.4 Inactivity logoff

Intended use

Intended use of inactivity logoff is to protect an Operator Client or Configuration Client during the absence of the operator or administrator.

You can configure per user group that Operator Client shall be logged off automatically after a specified time period without activity.

For Configuration Client no user groups are available. The inactivity logoff setting is valid only for the **admin** user.

All operations with keyboard, mouse and CCTV keyboard affect the specified time period for inactivity logoff. Automatic activities of Operator Client do not affect the time period.

Automatic activities of Configuration Client like firmware upload or iSCSI setup prevent the inactivity logoff.

You can also configure the inactivity logoff for a BVMS Web Client.

Short before an inactivity logoff, a dialog box reminds the user to actively prevent the inactivity logoff.

The Logbook records an occurred inactivity logoff.

Example

If a workstation is located in a public area, the inactivity logoff minimizes the risk that on an unattended workstation Operator Client is accessed by an unauthorized person.

An administrator group member shall logoff automatically after inactivity but a desk officer (operator group) might just watch video without operating the system and does not want an inactivity logoff.

Limitations

Client SDK activity does not support the inactivity logoff, this means that the activity of Client SDK does not affect the specified time period.

5.5 Version independent Operator Client

For Compatibility mode both Operator Client and Management Server must have a version later than 5.5.

A user of Operator Client can successfully log on to a Management Server where a previous software version is running.

If the server provides a newer configuration than available on the Operator Client workstation, this configuration is automatically copied to the Operator Client workstation.

The user can decide to download the new configuration.

Operator Client provides a reduced feature set and is connected to this Management Server.

The following Management Server related features are available after logon to a Management Server with a previous version:

- User preferences
- Start manual recording
- Display of device states
- Toggling relay states
- Searching the Logbook
Search for events is not possible.
- Server Lookup
- Remote export

5.5.1 Working with Compatibility Mode



: This Operator Client state displays in case of compatibility mode.

In version later than 5.5, the Operator Client will work in compatibility mode if the version of the Management Server is lower than the version of the Operator Client.

In version later than 10.0, the Operator Client will work in compatibility mode in case of the following:

- Not all communication services could be connected by Operator Client.
- Example: The Management Server is up and running, but WebServiceHost is down.
- There are changes within the communication interface between Operator Client and Management Server

Only semantic interface changes or partial drop of services may cause that some functionalities can be missing in the Operator Client.

5.6 Viewing modes of a panoramic camera

This chapter illustrates the viewing modes of a panoramic camera which are available in BVMS.

The following viewing modes are available:

- Circle view
- Panorama view
- Cropped view

Panorama and cropped view modes are created by the dewarping process in BVMS. Edge dewarping is not used.

The administrator must configure the mounting position of a panoramic camera in Configuration Client.

You can resize the Image pane of a camera as required. The Image pane ratio is not restricted to the 4:3 or 16:9 aspect ratio.

Refer to

- *Displaying a panoramic camera, page 38*
- *Switching the viewing mode of panoramic camera, page 39*
- *Arranging and resizing Image panes, page 41*

5.6.1 360° panoramic camera - floor- or ceiling mounted

The following figure illustrates the dewarping of a 360° camera which is floor- or ceiling mounted.

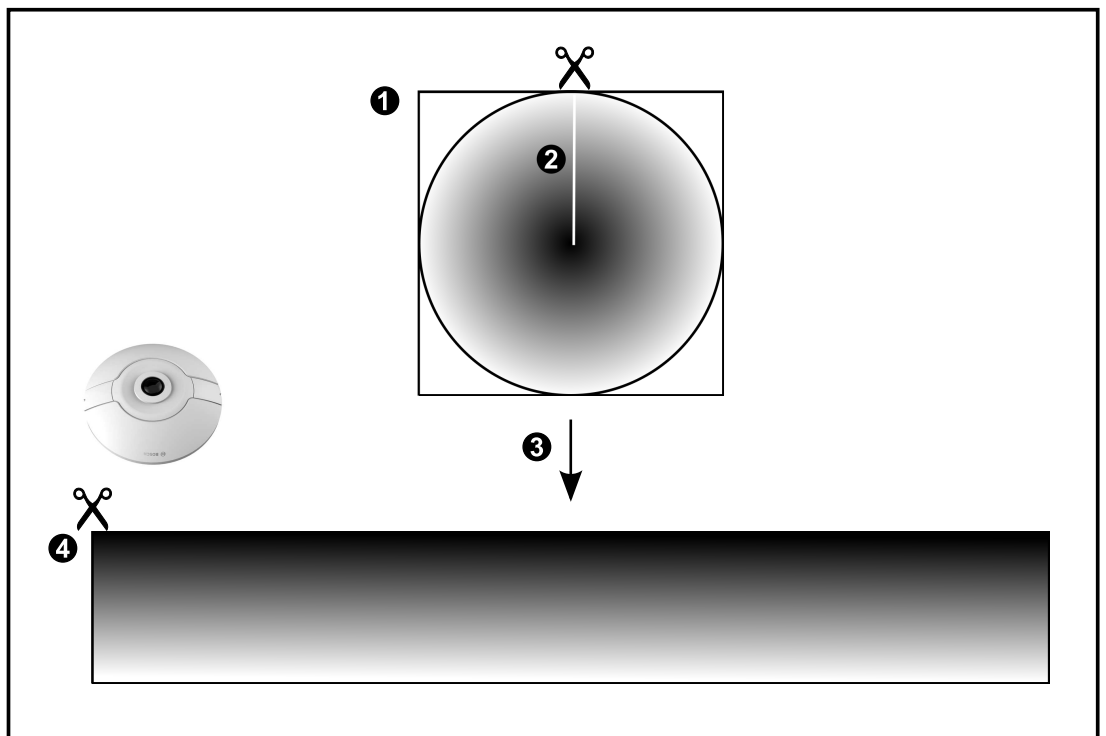
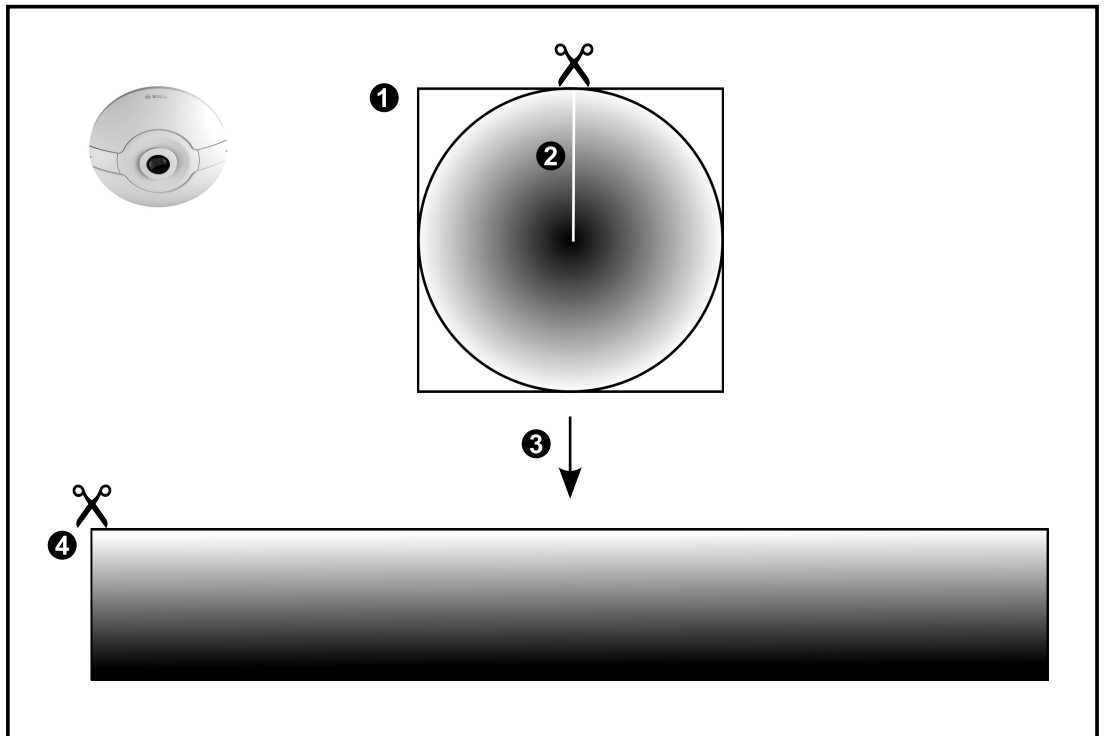

1	Full circle image	3	Dewarping
2	Snipping line (operator can change its position when not zoomed in)	4	Panorama view

5.6.2

180° panoramic camera - floor- or ceiling mounted

The following figure illustrates the dewarping of a 180° camera which is floor- or ceiling mounted.

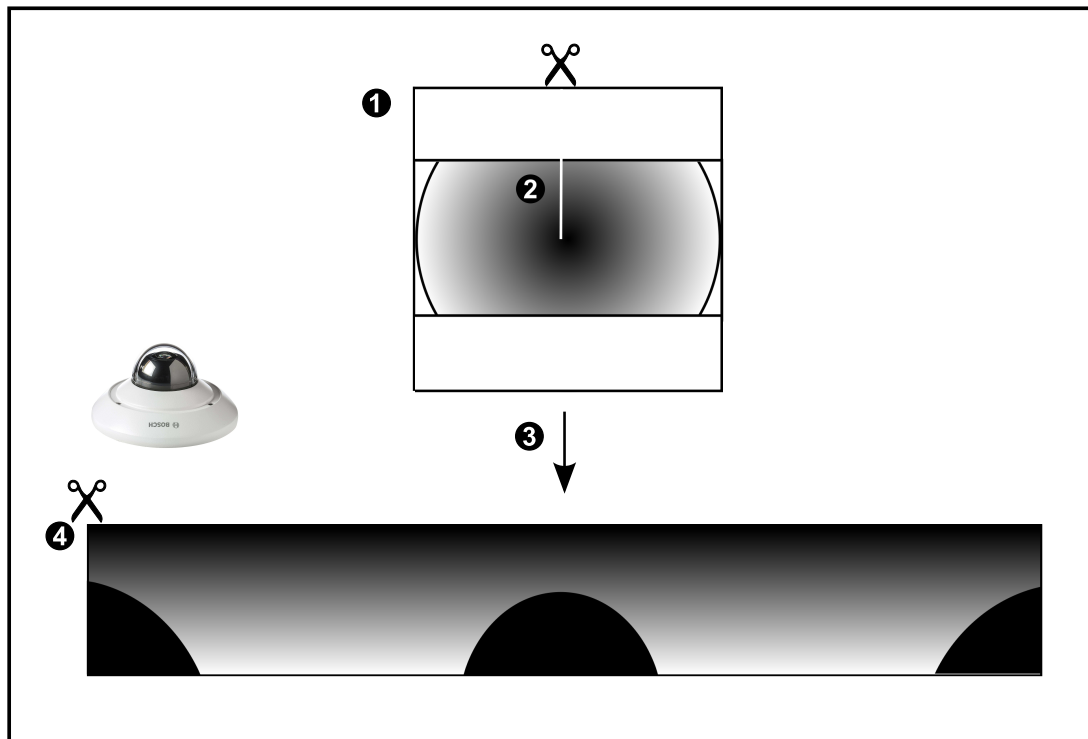
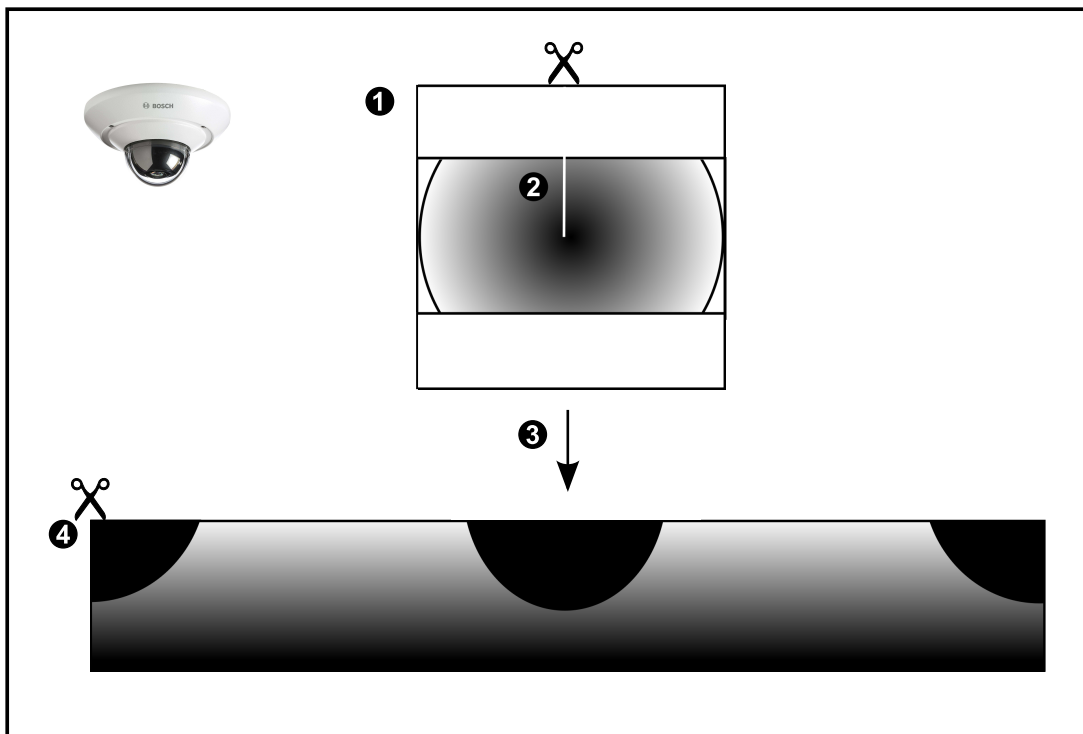

1	Full circle image	3	Dewarping
2	Snipping line (operator can change its position when not zoomed in)	4	Panorama view

5.6.3

360° panoramic camera - wall mounted

The following figure illustrates the dewarping of a 360° camera which is wall mounted.

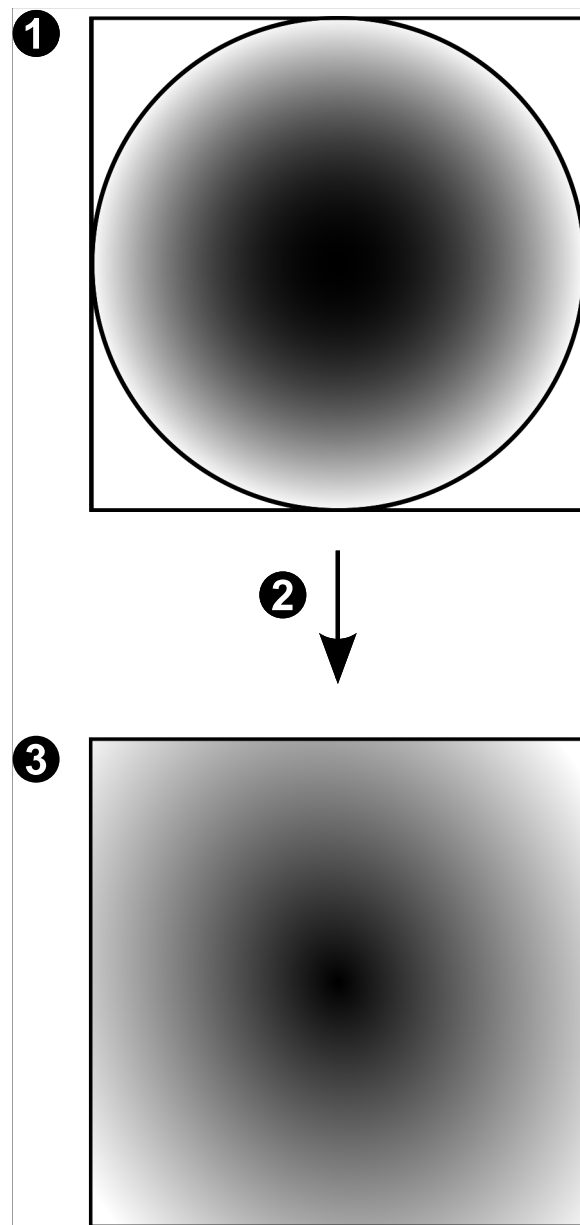

1	Full circle image	3	Panorama view
2	Dewarping		

5.6.4 180° panoramic camera - wall mounted

The following figure illustrates the dewarping of a 180° camera which is wall mounted.

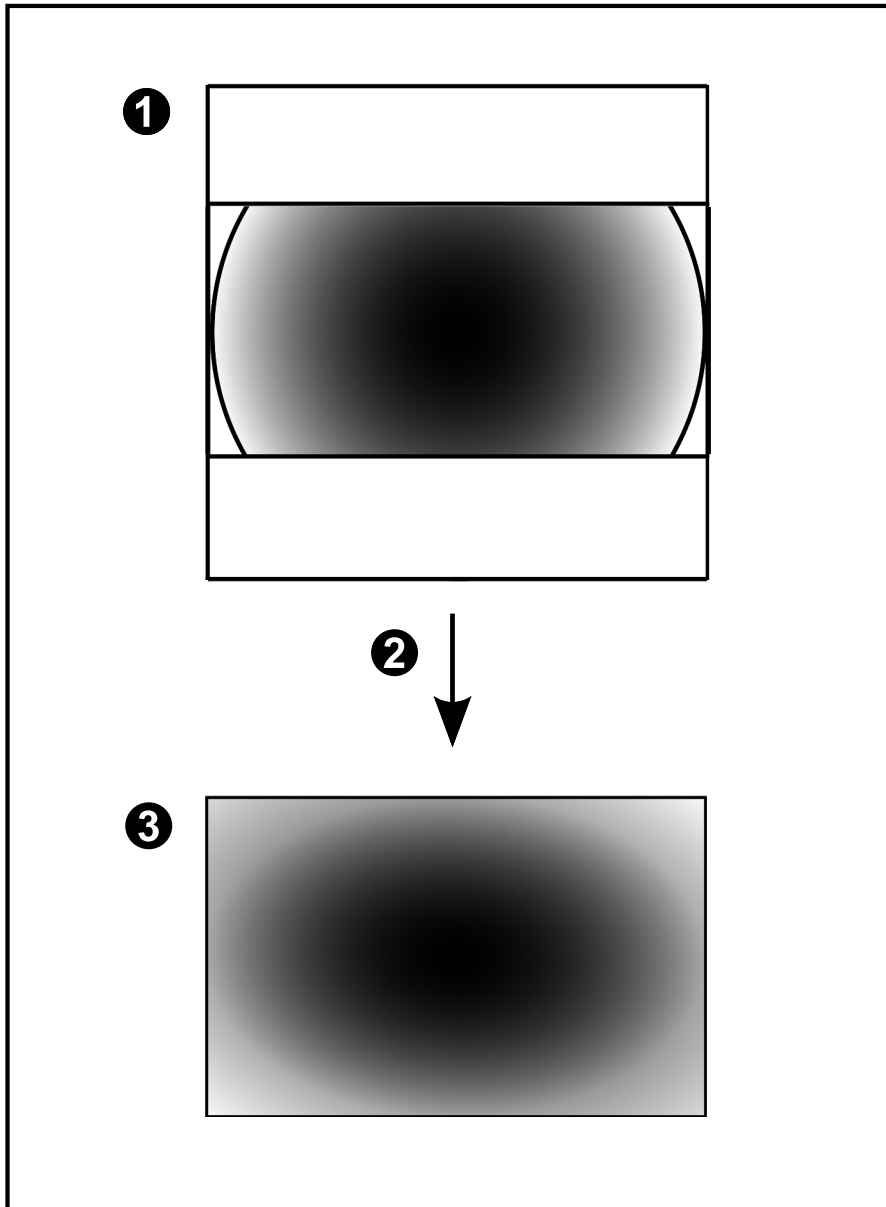

1	Full circle image	3	Panorama view
2	Dewarping		

5.6.5 Cropped view on a panoramic camera

The following example figure illustrates the cropping of a 360° camera which is floor- or ceiling mounted.

The rectilinear section used for cropping is fixed. You can change the section in the cropped Image pane using the available PTZ controls.

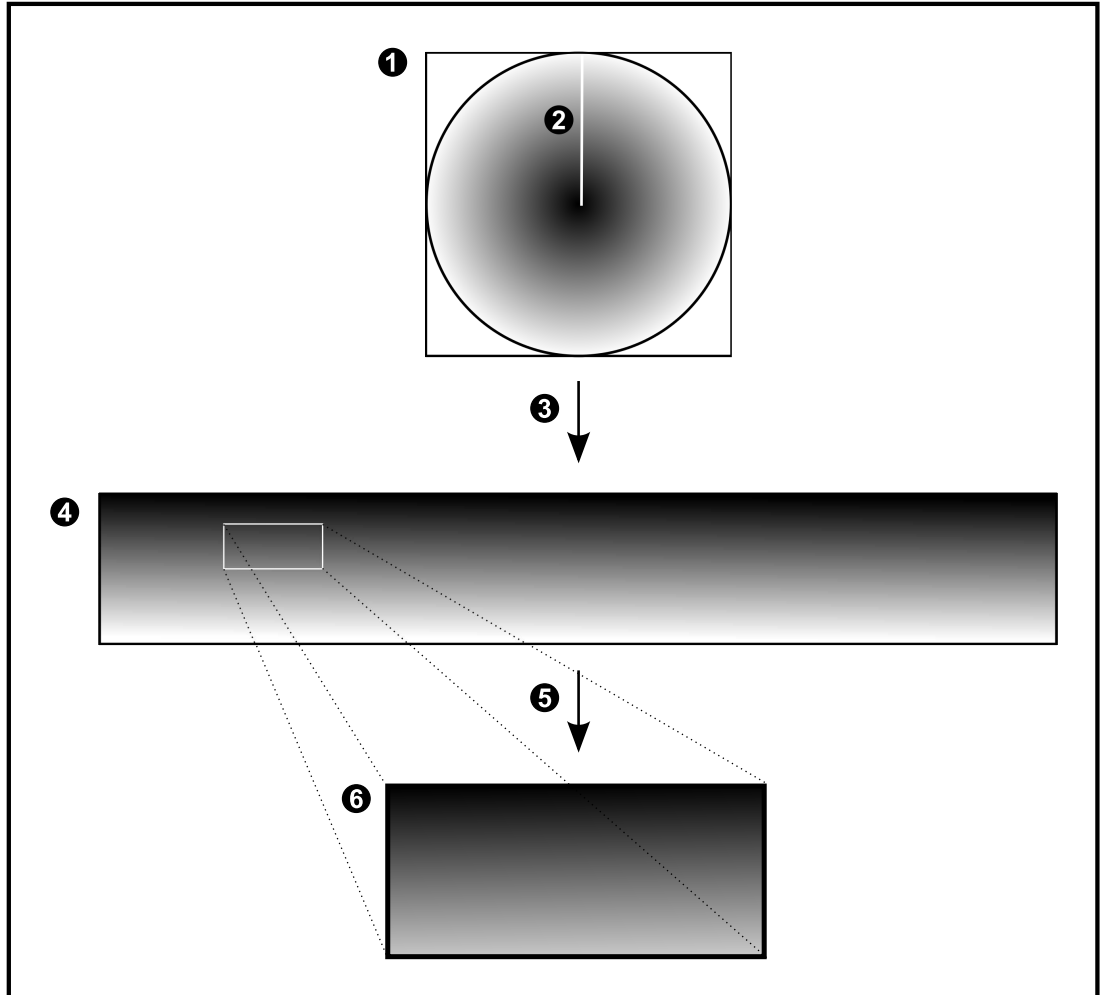

1	Full circle image	4	Panorama view
2	Snipping line (operator can change its position when not zoomed in)	5	Cropping
3	Dewarping	6	Cropped Image pane

5.7 SSH Tunneling

BVMS provides remote connectivity utilizing Secure Shell (SSH) tunneling. SSH tunneling constructs an encrypted tunnel established by an SSH protocol/socket connection. This encrypted tunnel can provide transport to both encrypted and un-encrypted traffic. The Bosch SSH implementation also utilizes Omni-Path protocol, which is a high performance low latency communications protocol developed by Intel.

Technical aspects and restrictions

- SSH tunneling utilizes port 5322. This port cannot be modified.
- The SSH Service must be installed on the same server as the BVMS Management Server.
- (Enterprise) user accounts must have a configured password. (Enterprise) user accounts without a password cannot log on utilizing a SSH connection.
- Local storage cameras do not support SSH connection.
- Configuration Client cannot connect remotely via SSH. Configuration Client connection must be done via port mapping.
- Operator Client checks connection with SSH service every 15 seconds. If the connection is interrupted, Operator Client retests the connection every minute.

Port mapping

- ▶ Configure one port forwarding for the BVMS Management Server to utilize port 5322 for both internal and external connections.
This is the only port mapping entry that you need to make for the entire system.
BVMS port mapping is not required.

Encrypted communication

After the connection is established via a SSH tunnel, all communications between the BVMS Management Server and a remote client are encrypted.

6 Use latest software

Before operating the device for the first time, make sure that you install the latest applicable release of your software version. For consistent functionality, compatibility, performance, and security, regularly update the software throughout the operational life of the device. Follow the instructions in the product documentation regarding software updates.

We only create new updates for software versions in general or limited availability state. For more information, refer to:

[Bosch Building Technologies Software Service and Support](#).

The following links provide more information:

- General information: <https://www.boschsecurity.com/xc/en/support/product-security/>
- Security advisories, that is a list of identified vulnerabilities and proposed solutions: <https://www.boschsecurity.com/xc/en/support/product-security/security-advisories.html>

Bosch assumes no liability whatsoever for any damage caused by operating its products with outdated software components.

7 Getting started

This chapter provides information on how to get started with BVMS.

7.1 Starting Operator Client

Note:

- Before using the system, activate the licenses that you have ordered. The Configuration Manual or the Configuration Client Online Help describe how to activate the licenses.
- To be sure that your BVMS uses the language that you need, please configure this language in your Configuration Client. See the Online Help for details.

If a newer version of BVMS is running on the Management Server, this version is installed automatically by no-touch deployment when you log on.

To start the Operator Client:

1. From the **Start** menu, select **Programs** > BVMS > Operator Client.
The dialog box for logging on is displayed.
2. Type your user name in the **User Name:** field.
3. Type your password in the **Password:** field.
Note: When you start the application for the first time, type Admin as user name, no password required.
To access multiple Management Server computers simultaneously, type the user name of a member of an Enterprise User Group.
4. In the **Connection:** list, select the IP address or the DNS name of the Management Server or Enterprise Management Server.
Note: If you use a SSH connection, select **<New...>** and enter the address in the following format: **ssh://IP or servername:5322**.
To use a SSH connection user accounts must have a configured password (see *SSH Tunneling, page 32*).
5. Click **OK**.
If dual authorization has been configured for your user group, the next logon dialog is displayed.
A user of the configured second user group enters the required information.
The application starts.
If dual authorization is optional, just click **OK** again on the second logon dialog box. But you then only have the user rights of your user group and not the potentially extended user rights of your dual authorization group.

To start the Operator Client using Single Sign-on:



Notice!

To start the Operator Client using Single Sign-on, the user has to be associated to a LDAP user group that is configured in the Configuration Client.
SSH connection and dual authorization are not supported if a user connects to the Operator Client using Single Sign-on.

1. From the **Start** menu, select **Programs** > BVMS > Operator Client.
The dialog box for logging on is displayed.
2. Select the **Use Windows session credentials** check box.
3. In the **Connection:** list, select the IP address or the DNS name of the Management Server or Enterprise Management Server.
4. Click **OK**.

To quit Operator Client:

1. On the **System** menu, click **Exit**.
The application quits.
If you logged on to Operator Client as a user who is not authorized to quit the application, the **Enter Logoff Password** dialog box is displayed.
2. Ask a user with corresponding user rights to enter his user name and password to confirm the process.

Refer to

– *SSH Tunneling, page 32*

7.2 Starting Operator Client with command line parameters

The BVMS Operator Client provides automatic logon by using a parameterized startup. Therefore, create a new shortcut to the OperatorClient.exe and adjust the target of the shortcut.

Adjust the text between ** to the specific situation.

```
*BVMS installation directory*\bin\OperatorClient.exe" /user="*username*" /password="*password*" /connection="*ip address**"
```

Example:

```
C:\Program Files\BOSCH\VMS\bin\OperatorClient.exe" /user="Admin" /password="password123" /connection="192.168.20.120"
```

The connection parameter works from BVMS 9.0 and newer. The username and password parameters work from BVMS 5.0 onwards.

**Notice!**

Username and password are stored as clear text in the target of the shortcut. This can be considered a security risk.

7.3 Accepting a new configuration

When the system administrator activates a new configuration from within Configuration Client, each Operator Client is either immediately restarted automatically or the user of a workstation is informed about the new configuration and can accept it later. The system administrator configures which of these 2 cases occurs.

If the system administrator activated a new configuration without forcing each Operator Client workstation to accept the new configuration, a dialog box is displayed on all Operator Client workstations. The users can refuse or accept the new configuration. The dialog box is closed after a few seconds without user interaction. In this case the new configuration is refused. If a device (for example a camera) is removed from the system in the new configuration, some functions of this device are not available if you have refused the new configuration.

If you change the password for a user or delete a user while this user is logged on, this user can still continue working with Operator Client after password change or deletion. If after password change or deletion the connection to Management Server is interrupted (for example after activating the configuration), the user cannot automatically reconnect to the Management Server again without logoff/logon at Operator Client.

To accept a new configuration:

- ▶ Log off and then log on again.
The new configuration is used now.

7.4 Accessing the system

You access a system performing the following steps:

1. Perform one of the following steps to select the network address of the desired system:
 - Click a preselected list entry.
 - Enter a network address manually.
 - Select a network address using Server Lookup.
2. Log on to the desired system:
 - Single server system
 - Enterprise System

7.5 Using Server Lookup

- The BVMS Server Lookup feature allows Operators to connect to a BVMS Management Server out of a provided list of servers.
- A single user of Configuration Client or Operator Client can connect to multiple system access points sequentially.
- System access points can be Management Server or Enterprise Management Server.
- Server Lookup uses dedicated Management Server to host the Server List.
- Server Lookup and Management Server or Enterprise Management Server functionally can be run on one machine.
- Server Lookup supports you in locating system access points by their names or descriptions.
- Once connected to the Management Server the Operator Client receives events and alarms from the BVMS Management Server and shows live and playback

To access:

1. Start Operator Client or Configuration Client.
The logon dialog box is displayed.
2. In the **Connection:** list, select **<Address Book...>** for Configuration Client or **<Address Book...>** for Operator Client.
If private and public IP address has been configured for a server, this is indicated.
If you select **<Address Book...>** or **<Address Book...>** for the first time, the **Server lookup** dialog box is displayed.
3. In the **(Enterprise) Management Server address** field, type in a valid network address of the desired server.
4. Enter a valid user name and password.
5. If required, click **Remember settings**.
6. Click **OK**.
The **Server lookup** dialog box is displayed.
7. Select the desired server.
8. Click **OK**.
9. If the selected server has both a private and a public network address, a message box is displayed asking whether you are using a computer located in the private network of the selected server.
The server name is added to the **Connection:** list in the logon dialog box.
10. Select this server in the **Connection:** list and click **OK**.
If you have selected the **Remember settings** check box, you can select this server directly when you again want to access this server.

8 Displaying camera images

This chapter provides information on how to display camera images. Some of the features described in this chapter can be deactivated for your user group.



Notice!

This document describes some functions that are not available for BVMS Viewer. For detailed information about the different BVMS editions refer to www.boschsecurity.com and the BVMS Quick Selection Guide: [BVMS Quick Selection Guide](#).

8.1 Selecting a time zone

Main window



Notice!

Ensure that the time on all computers of your system is set correctly according to each time zone where the computers are located.

Management Server or unmanaged site and all connected devices including encoders, decoders, VRM Server computers, and DVR devices must be in the same time zone. Operator Client computers (including Client SDK and Cameo SDK) and Configuration Client computers can be in other time zones than the Management Server or unmanaged site. If your Operator Client is located in another time zone than one or more connected Management Server or unmanaged site, you can select one of the following time displays:

- Your local time
 - UTC
 - Time zone of the Management Server or unmanaged site you are connected to
- The Image panes displaying a camera (live and playback) always show the time of the corresponding Management Server or unmanaged site.

In the Logical Tree,  is displayed on the device icon of each server or unmanaged site that do not share the time zone that is currently selected in the Operator Client:

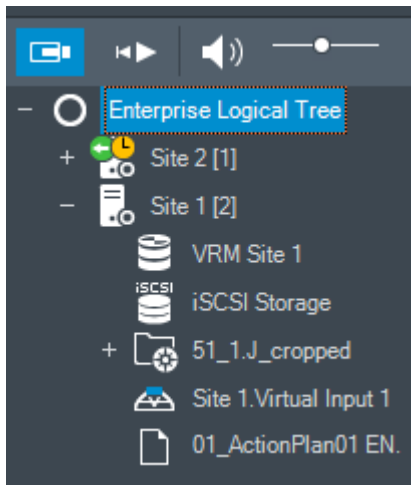

You can select the time zone of a server or unmanaged site for displaying this time zone in Operator Client.

To select the time zone:

1. In the Logical Tree, right-click a server icon to select the time zone of this server.
2. In the time zone selector list, select the desired entry.
 - **Operator Client Time:** Operator Client

- **UTC**
- **UTC-x**: time zone of each available Management Server

The time based on the selected time zone is displayed in the menu bar:

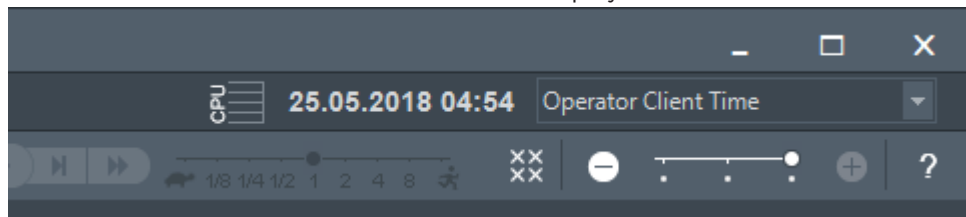

Refer to

- *Logical Tree window, page 142*

8.2 Displaying a camera in an Image pane

Main window

To assign a camera image to an Image pane:

- ▶ Drag a camera from the **Logical tree** window to an Image pane.
The selected camera image is displayed in the Image pane.

Or:

1. Select an Image pane.
2. In the **Logical tree** window, double-click a camera.
The selected camera image is displayed in the Image pane.
3. Repeat the above steps for every camera you want to display.
You can also drag maps and documents to Image panes.

Or:

- ▶ In the Logical Tree, right-click a camera and click **in next free image pane**.
The camera is displayed.

To move a camera within the Image window:

- ▶ Drag the camera into another Image pane.

To zoom digitally:

- ▶ Rotate the wheel button forward or backward to zoom in or zoom out.

Refer to

- *Logical Tree window, page 142*
- *Image window, page 143*
- *Image pane, page 144*

8.3 Displaying a panoramic camera

Main window

You can display panoramic cameras. The original full image circle of a panorama camera is automatically dewarped when displayed in an Image pane.

You can display panoramic cameras and use PTZ in Live Mode and Playback Mode

You can select a point of interest of the panorama image for display in another Image pane. This Image pane displays the cropped image. Cropping and using PTZ in a cropped image is possible in Live and Playback Mode.

The Image window allows a flexible resizing of the Image pane that displays a panoramic camera or any other camera.

To display a panoramic camera:

1. Drag a camera with the  icon to an Image pane.
The camera image is displayed in panorama view.
2. Use the available control elements in the Image pane for navigating in the image.

To display a cropped image:

1. Display a panoramic camera in panorama view.
2. Press and hold the CTRL-key.
The mouse pointer changes accordingly.
3. Click and hold a point of interest.
4. Drag the selected point to another Image pane and drop it. Release the CTRL-key.
A section of the panorama view around the selected point is displayed.
You can create another cropped image from this cropped image with the same procedure. We recommend displaying maximum 10 cropped Image panes simultaneously.
5. Use the available control elements in the Image pane for navigating in the image.

Refer to



- *Switching the viewing mode of panoramic camera, page 39*
- *Arranging and resizing Image panes, page 41*
- *Viewing modes of a panoramic camera, page 26*

8.4 Switching the viewing mode of panoramic camera

A panoramic camera must be configured in the Logical Tree for this user.

You can switch the viewing mode for a panoramic camera displayed in an Image pane.

The following modes are available:

-  **Circle view**
-  **Panorama view** (initial view)
-  **Cropped view**

To switch:

- ▶ In the title bar of an Image pane displaying a panoramic camera, click the **Switch panoramic mode** icon and select the desired entry.

When the Image pane for this camera is closed and opened again, the **Panorama view** mode is displayed.

Refer to

- *Displaying a panoramic camera, page 38*
- *Viewing modes of a panoramic camera, page 26*
- *Image pane, page 144*

8.5 Displaying a dual thermal/optical camera

In Operator Client you can display the thermal and optical mode of a dual camera either separately or simultaneously.

To display the desired viewing mode of the camera:

- ▶ Drag the camera to an Image pane
or
Select an Image pane and in the **Logical Tree** window, double-click the desired camera.
The selected camera image is displayed in the Image pane.
The viewing mode is displayed in the title bar of the Image pane:

-  **Optical**
-  **Thermal**

To switch the viewing mode of the camera:

- ▶ In the title bar of the Image pane displaying the camera, select the desired viewing mode.

To display the thermal and optical mode of the camera simultaneously:

1. Select the Image pane displaying the camera.
2. Press the CTRL-key and drag and drop the camera image to another Image pane.
The second viewing mode of the camera is displayed in the new Image pane.

8.6 Displaying cameras from multiple Management Servers

Main window > **Enterprise Logical Tree**

Log on as a user of an Enterprise User Group.

In the Enterprise Logical Tree, expand the item of the desired Management Server. You can use the devices that are configured for this Management Server.

8.7 Finding an item in the Logical Tree



Main window

To find an item in the Logical Tree:

1. Right-click the root node or a child node of the Logical Tree and click **Tree search**
Or:

In the Logical Tree window press Ctrl + F.

The search box is displayed 

2. Type a search string representing the display name of an item.
The search is triggered immediately during typing and the first item that matches the search string is marked. If you want to display it in an Image pane, double-click it.
If the search string is not found, the background color of the search box changes.
3. Click  or  to mark the previous or the next matching item.
4. Click  to close the search box.

Refer to

- *Search box, page 145*

8.8 Changing the number of Image pane rows

Main window

You can change the number of Image pane rows displayed in the Image window.

To show fewer image pane rows:

- ▶ On the **Tools** menu, click **Show fewer Image pane rows**
or

Move the **Change image pane rows** slider  to the left

or

Click 

or

Press F7.

To show more Image pane rows:

- ▶ On the **Tools** menu, click **Show more Image pane rows**
- or

Move the **Change image pane rows** slider  to the right

or

Click 

or

Press F8.



Notice!

The maximum number of Image pane rows displayed in the Image window is configured in the BVMS Configuration Client.

If you have reached this number, the **Show more Image pane rows** menu command and the

 button are disabled.

If the maximum number of Image pane rows has been set to 1, the **Change image pane**

rows slider  is not displayed.



Notice!

This limitation does not affect the BVMS Export Player.

8.9

Arranging and resizing Image panes

Main window

To arrange Image panes:

1. Drag an item from the **Logical tree** window to an Image pane. Repeat this until all required cameras are displayed.
If an object is already displayed in a target Image pane, this object is replaced.
2. Drag a camera from one Image pane to another, if required.

To resize an Image pane:

1. Point to a border or corner of an Image pane. The pointer appears as a double-headed arrow.
You can resize diagonally, vertically or horizontally.
The resulting size of the Image pane is limited to the grid of the select Image pane pattern.
The Image pane ratio is not restricted to the 4:3 or 16:9 aspect ratio.
2. Drag to resize the Image pane.

Refer to

- *Image window, page 143*

8.10 Displaying the Alarm Image window

Main window

You can switch from the Image window to the Alarm Image window if at least one alarm is in the Alarm List.



Notice!

A site map displayed in an alarm image pane is optimized for display and contains only the initial view of the original map file.

To display the Alarm Image window:

- ▶ In an Image window, click  .
The Alarm Image window is displayed.

To display the Image window again:

- ▶ In an Image window, click  .
Live Mode or Playback Mode is displayed depending on the Mode that was displayed before.

Refer to

- *Alarm display, page 128*
- *Image window, page 143*

8.11 Starting manual recording

Main window

You can start recording for each camera manually. The quality level of alarm recording mode is used. The duration of alarm recording is configured in the Configuration Client.

If the selected camera is already recording, the quality level is changed to alarm recording mode. With VRM recording, the alarm recording is not protected.

To start recording:

1. Select an Image pane displaying a camera.
2. Click  .
Recording is started.

VRM recordings only: You cannot manually stop recording. The recording stops after the configured alarm recording time. In the Timeline of the camera, the pre-alarm recording is displayed as alarm recording, if pre-alarm recording is configured in Configuration Client.

Refer to

- *Image pane, page 144*
- *Timeline window, page 147*

8.12 Starting a pre-configured camera sequence

Main window

With a camera sequence, a group of cameras are displayed one after the other. The pre-configured camera sequences are configured in the Configuration Client and appear in the Logical Tree.

A sequence is configured to use more than one image pane in Operator Client or in a monitor group. If there are not enough image panes or monitor panes to display the whole sequence, only those panes are displayed which fit into the image window. The remaining panes are not displayed and an appropriate message is displayed.

Under the following conditions, a sequence is not being displayed:

- Video loss
- Connection to the camera lost
- No permission to display the camera
- Camera not configured



Notice!

When the configuration is changed and activated, a camera sequence (pre-configured or automatic) usually is continued after restart of the Operator Client.

But in the following cases the sequence is not continued:

A monitor where the sequence is configured to be displayed has been removed.

The mode of a monitor (single/quad view) where the sequence is configured to be displayed has been changed.

The logical number of a monitor where the sequence is configured to be displayed is changed.

To start and control a camera sequence:

1. Drag the required sequence  from the **Logical tree** window to an image pane or to a monitor group.

The sequence is displayed indicated by the  symbol when running in an image pane.

2. When running in an image pane: Click a playback control icon of the image window toolbar to control the sequence.

Refer to

- *Image pane, page 144*

8.13

Starting an automatic camera sequence

Main window

With a camera sequence, a group of cameras are displayed one after the other.

You configure the dwell time for these sequences in the **Options** dialog box (**Extras** menu, **Options...** command).

Under the following conditions, a sequence is not being displayed:

- Video loss
- Connection to the camera lost
- No permission to display the camera
- Camera not configured

**Notice!**

When the configuration is changed and activated, a camera sequence (pre-configured or automatic) usually is continued after restart of the Operator Client.

But in the following cases the sequence is not continued:

A monitor where the sequence is configured to be displayed has been removed.

The mode of a monitor (single/quad view) where the sequence is configured to be displayed has been changed.

The logical number of a monitor where the sequence is configured to be displayed is changed.

To start a camera sequence:

1. Select an Image pane where you want the sequence to be played.
2. Right-click a folder in the **Logical Tree** and click **Show as sequence in selected image pane**.

The cameras of the selected folder are displayed one after the other in the selected



Image pane.  indicates that the sequence is running.

To pause a camera sequence:

- ▶ In the Image window toolbar, click .

The sequence stops playing, as indicated by .

To jump to the previous / next step of a camera sequence:

- ▶ In the Image window toolbar, click  or .

The sequence jumps to the previous or next step.

Refer to

- *Options dialog box, page 139*

8.14 Using one channel audio mode

Main window

You use one channel audio mode when you want to hear only one audio source assigned to a camera. You cannot activate audio for another camera.

To activate / de-activate multichannel audio mode:

1. On the **Extras** menu, click **Options...**
2. Select the **Playback audio of the selected Image pane** check box.

Refer to

- *Options dialog box, page 139*

8.15 Using multichannel audio mode

Main window

You use multichannel audio mode when you want to hear different audio sources at the same time. You can activate different audio sources assigned to a camera in the Image pane of each camera.

To activate / de-activate multichannel audio mode:

1. On the **Extras** menu, click **Options...**
2. Select the **Multichannel audio playback** check box.

Refer to

- *Options dialog box, page 139*

8.16 Using digital zoom

Main window

Every Image pane provides a digital zoom function. This digital zoom has 11 levels: 1x, 1.35x, 1.8x, 2.5x, 3.3x, 4.5x, 6x, 8.2x, 11x, 14.9x, 20.1x.

When you save a Favorites View, the current setting of the digital zoom and the image section are saved.

When you click  , the current setting of the digital zoom and the image section are used for instant playback.

When Operator Client restarts, the current setting of the digital zoom and the image section are retained.

To use digital zoom:

1. Rotate the wheel button forward or backward to zoom in or zoom out.



indicates that the digital zoom was used.

2. Drag the image to navigate to the desired image section.
3. Right-click the Image pane and click **Zoom 1:1** to return to the original size.



disappears.

Note:

You can also use the controls for digital zoom in the **PTZ Control** window. When you rotate the wheel button for PTZ cameras, you use optical zoom.

Refer to

- *Using in-window control of a PTZ camera, page 56*
- *Favorites Tree window, page 142*
- *PTZ Control window, page 146*
- *Image pane, page 144*

8.17 Saving a single image pane

Main window

To save a single image pane:

1. Select an Image pane.



2. Click  .

A dialog box for saving the image file is displayed.

3. Select the desired directory, enter a file name, and select the desired file type. JPG and BMP are available.

4. Click **OK**.

The image pane is saved. The file contains additional information about the camera, map or map viewport.

If you logged on to an Enterprise Management Server, the camera name is displayed with the name of this camera's Management Server as a prefix.

Refer to

- *Image pane, page 144*

8.18 Printing a single image pane

Main window

To print a single image pane:

1. Select an Image pane.

2. Click  .

A dialog box for selecting the printer is displayed.

3. Click **OK**.

The image pane is printed. The printout contains additional information about the camera, map or map viewport.

If you logged on to an Enterprise Management Server, the camera name is displayed with the name of this camera's Management Server as a prefix.

Refer to

- *Image pane, page 144*

8.19 Switching to full-screen mode

Main window

Full-screen mode hides many control elements, for example the menu commands or the Alarm List if no alarm monitor was switched to full-screen mode. For accessing these control elements, leave the full-screen-mode.

To display the entire Image window in full-screen mode:

- ▶ On the Image window toolbar, click  .
The Image window is displayed in full-screen mode.

To leave the full-screen mode:

- ▶ Click  .

To maximize a selected Image pane:

- ▶ Right-click an Image pane and click **Maximize**.
The selected Image pane is displayed using the entire Image window.

Refer to

- *Image window, page 143*

8.20 Displaying or hiding the Image pane bars

Main window

To display / hide the toolbars:

- ▶ Click  to display the toolbars of the selected image pane.

Click  to hide the toolbars of the selected image pane.

Refer to

- *Image window, page 143*

8.21 Displaying information on a camera

Main window

To display information:

- ▶ Right-click an Image pane with a camera assigned and click **Properties**.
A dialog box with the camera properties is displayed.

Refer to

- *Image pane, page 144*

8.22 Enabling video content analysis (VCA)

Main window

or

alarm image window

To enable:

- ▶ Right-click an Image pane or alarm image pane with a camera assigned and click **Enable Content Analysis**.
The VCA overlays are displayed.

To disable:

- ▶ Right-click an Image pane or alarm image pane with a camera assigned and click **Disable Content Analysis**.
The VCA overlays disappear.

This setting is retained after the next restart or re-logout of Operator Client, after closing the camera and displaying it again in an Image pane, or after an alarm with the assigned camera is triggered again.

8.23 Showing video content analysis (VCA) rules

Main window

To show VCA rules:

- ▶ Right-click an Image pane with a camera assigned and click **Show Content Analysis rules**.
The VCA rules are displayed.

To hide VCA rules:

- ▶ Right-click an Image pane with a camera assigned and click **Hide Content Analysis rules**.
The VCA rules disappear.

This setting is not persistent after the next restart or re-logout of Operator Client or after closing the camera and displaying it again in an Image pane.

8.24 Starting instant playback

Main window >





You can view the recordings of a camera in an Image pane in the Live Mode.

If configured you can change the recording source.

The current setting of the digital zoom and the image section are used for instant playback. The start time (number of seconds in the past or rewind time) for instant playback is configured in the **Options** dialog box (**Extras** menu, **Options...** command).

To start instant playback:

1. Select the required Image pane.
2. Click  .
The recording is played.
3. Switch to the desired recording source if available.
Note: After switching the recording source the rewind time can deviate from the configured value.

- ▶ To return to live image, click .

Note: More than one Image pane with instant playback is possible, even multiple instant playbacks of the same camera.

The rewind time for instant playback is configured in the *Control tab, page 140*.

To start/stop loop playback:

- ▶ Click .

The duration of looped instant playback in the live image pane is the rewind time backwards plus the rewind time forwards from the time you click .

Refer to

- *Control tab, page 140*
- *Image pane, page 144*
- *Switching the recording source, page 99*
- *Options dialog box, page 139*

8.25 Assigning a camera to a monitor

Main window >  > 

You can assign IP devices to a decoder. This displays the video signal on the monitor and plays the audio signal on the speakers if connected to the decoder. Bosch Allegiant cameras cannot be assigned this way.

To assign a camera image to a monitor:

- ▶ Drag a camera from the  window to the desired monitor in the Image pane.

8.26 Using audio mode



Main window

If available you can activate audio for a selected camera.

To hear the audio signal of multiple cameras simultaneously, activate multichannel audio mode.

You switch the audio mode in the **Options** dialog box (**Extras** menu, **Options...** command).

To activate / de-activate audio:

1. Select an Image pane.
2. Click  to de-activate or  to activate audio.

Refer to

- Image pane, page 144
- Options dialog box, page 139

8.27 Using the Intercom functionality

Main window > 

You can use the Intercom functionality only when Live Mode is active.

Ensure that the microphone is active on your sound card and its volume is not 0. You perform this task in the Control Panel of your workstation computer. Additionally ensure that in the recording control of your sound card only the microphone is selected, not the stereo mix. For Windows 7: Disable all input devices except the one you want to use for Intercom functionality.

The following screenshot shows an example:

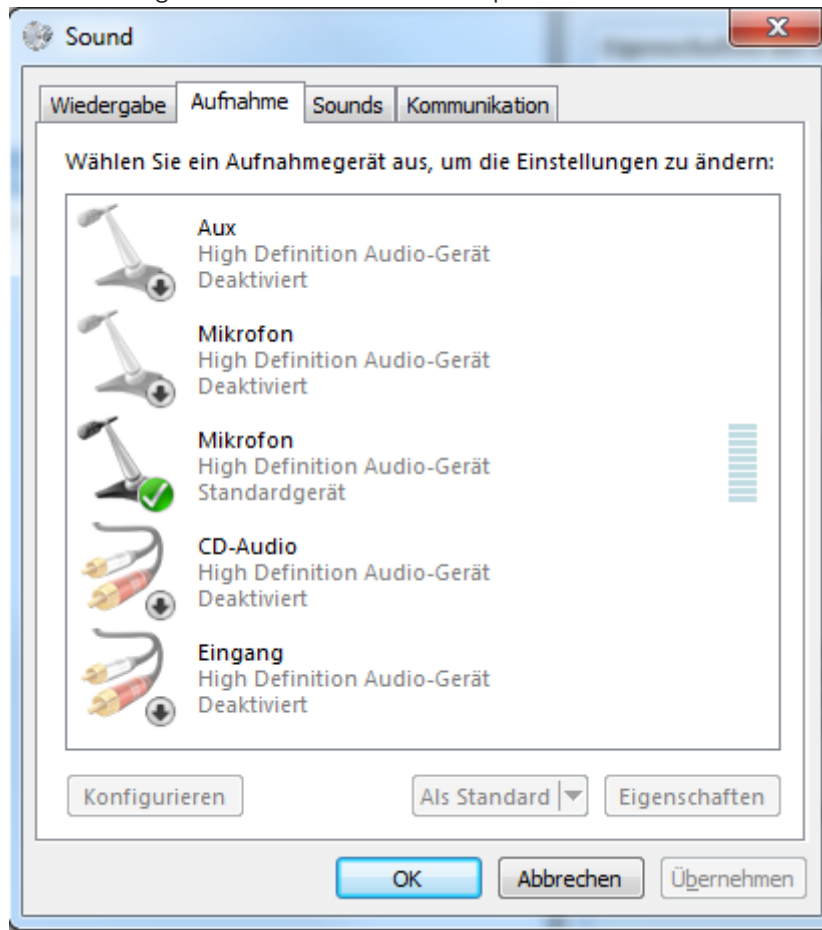

If you change the setting from stereo mix to microphone after the first start of Operator Client, the setting is overridden after the next start of Operator Client. We recommend to use a headset instead of a microphone-loudspeaker combination to avoid acoustic feedback.

The Intercom functionality only works with an encoder that has both audio-in and audio-out. Ensure that the volume settings for the encoder microphone and loudspeakers are not 0. You perform this task in Configuration Client.

To use Intercom functionality on your workstation your user group must be granted to use it. You perform this task in Configuration Client.

In the **Options** dialog box, you can configure half duplex or full duplex mode.

To use Intercom functionality:

1. Select an Image pane with an audio encoder.
2. Click  and hold the mouse button. If audio was off for this Image pane, it is switched on automatically.

The icon changes to .

Now you can talk. If configured, the other side can talk also, regardless whether the icon is clicked or not.

3. Release the mouse button. The transfer is interrupted.
Audio remains on for this Image pane.

**Notice!**

An incoming auto pop-up alarm can interrupt the transfer.

Refer to

- *Image window, page 143*

8.28**Locking the control of a PTZ camera**

Main window > 

You can lock the control of a PTZ camera for other users. A user with a higher priority can take over the control and lock the camera control. A timeout can be configured for this explicit PTZ locking. If you only take over the control without manually locking it before, the control is locked for the user with lower priority for 5 seconds.

To lock a PTZ control:

1. Select one of the following items:
 - Image pane with PTZ camera
 - PTZ camera in the Logical Tree
 - PTZ camera in the Favorites Tree
 - PTZ camera in the Map window
2. Right-click the Image pane or the PTZ camera and click **Lock**.
The users with lower priorities cannot use the PTZ control any longer. On their displays a corresponding message box is displayed.
To stop the locking of the PTZ control, right-click the Image pane or the PTZ camera and click **Unlock**.
The locking ends automatically after a configured time period or when you log off.

Refer to

- *Image window, page 143*
- *Map window, page 146*
- *Logical Tree window, page 142*
- *Favorites Tree window, page 142*

8.29**Updating the reference image**

Main window > 

You can update the reference image.

To update the reference image:

1. Right-click an Image pane and click **Reference Image...**
The **Reference Image** dialog box is displayed.
2. Click **Update**.
The image of the time when you click **Update** is displayed.

Reference Image dialog box**Camera view:**

Displays the live view of the selected camera.



Reference Image

Displays the reference image after clicking **Update**.

Update

Click to set the reference image. The image of the time when you click **Update** is used.

8.30 Displaying a monitor group

Main window >  > 

To assign a monitor group to an image pane:

1. Drag a monitor group from the **Logical tree** window to an image pane.
The selected monitor group is displayed in the image pane.
Or
select an image pane.
2. In the **Logical tree** window, double-click a monitor group.
The selected monitor group is displayed in the image pane.

To assign a camera to a monitor:

1. Drag a camera from the **Logical tree** window to a monitor.
The selected camera is displayed in the monitor.

Every assigned camera of a monitor group displays a snapshot. This snapshot helps you to identify, for example, if the correct camera is used or if the camera is reachable. The snapshot image is updated every minute.

To switch the layout of a monitor group:

▶ Click .

To reset the default layout settings of a monitor group:

1. Right-click the appropriate monitor group in the **Logical tree**.
2. Select **Reset to default layout settings**.

Note: The default layout settings of a MG are the settings, that are configured in the Configuration Client for this MG.

8.31 Selecting live stream for display

Main window > 

You can select the stream of a camera for display in an Image pane. This is for example useful when the default stream is not available. In this case you can switch to another stream.

In the Logical Tree you select the preferred stream to be used when the camera is displayed later.

In the Image pane of an already displayed camera you can switch the stream immediately.

The stream selection in an Image pane displaying a camera is retained after restarting Operator Client without explicitly closing this Image pane before. If the default stream has been selected in an Image pane and the default stream is changed using Configuration Client, the stream used for Live display is automatically changed after restart. You can save the stream selection of an Image pane in a view in the Favorites Tree. When using Operator Client with a version earlier than BVMS 5.5.5 to open a view previously saved with Operator Client 5.5.5, the default stream is used. When using Operator Client with version 5.5.5 to display a view that was saved with Operator Client with a version earlier than 5.5.5, the default stream is used.

To pre-select a preferred stream:

- ▶ In the Logical Tree, right-click a camera, point to **Preferred stream**, and then click one of the available menu commands.

When you drag this camera to an Image pane next time, the preferred stream is used for display.

To select a stream:

- ▶ Right-click the camera image in an Image pane, point to **Select stream**, and then click one of the available menu commands

The selected stream is used for display.

When you select **Image pane size optimized**, the resolution of the displayed camera is automatically adjusted to the size of the Image pane depending on the resolution of the used monitor.

The **Image pane size optimized** command is not available for the following cameras:

- Cameras with SD resolution
- Cameras with identical resolution on stream 1 and stream 2

Refer to

- *Using favorites and bookmarks, page 63*

8.32

Displaying video via low bandwidth

Main window

You can play back the recordings of a camera or view live images of a camera with Operator Client even if you have a low bandwidth network connection between BVMS and your Operator Client computer.

Transcoders do not support intelligent tracking, ROI, Intelligent Video Analytics overlays, and text data.

For using low bandwidth networks, 2 options are available:

- Hardware transcoding
- Software transcoding (only available for Live Mode)

Hardware transcoding

For hardware transcoding the VRM must be equipped with at least one transcoding device. This transcoding device is not configured in BVMS. See the VRM documentation on how to configure a transcoding device. Transcoding devices can have multiple transcoding instances.

DIVAR IP 3000 and DIVAR IP 7000 are delivered each with one preconfigured transcoding instance.

Each live stream or recording needs an own transcoding instance.

Hardware transcoding is possible only for Video IP devices from Bosch connected to a VRM. Both camera and transcoding device must be managed by the same VRM.

Software transcoding

For software transcoding you need a Mobile Video Service configured on your Management Server or your Enterprise Management Server.

In an Enterprise System only the MVS services are used that are configured in the Enterprise Management Server configuration.

To select the preferred transcoding device, use the **Options** dialog box.

To enable transcoding:

1. In the Logical Tree, right-click the desired camera, point to **Preferred stream**, and then click to enable **Transcoding**.
 2. Display the camera in an Image pane.
- ⇒ This camera shows transcoded video.

In the toolbar of this Image pane, the  icon for hardware transcoding or the  icon for software transcoding is displayed.

If the affected camera is already displayed in an Image pane, it continues displaying untranscoded video until you close this Image pane.

If a transcoding request cannot be fulfilled, the related Image pane turns black.

To disable transcoding in Live Mode:

1. In the Logical Tree, right-click the desired camera, point to **Preferred stream**, and then select another stream.
 2. Display the camera in an Image pane.
- ⇒ This camera shows untranscoded video.

The transcoding icon is not displayed.

If the affected camera is already displayed in an Image pane, it continues displaying transcoded video until you close this Image pane.

To disable transcoding in Playback Mode:

1. In the Logical Tree, right-click the desired camera, point to **Preferred stream**, and then click to disable **Transcoding**.
 2. Display the camera in an Image pane.
- ⇒ This camera shows untranscoded video.

The transcoding icon is not displayed.

If the affected camera is already displayed in an Image pane, it continues displaying transcoded video until you close this Image pane.



Notice!

You can also enable or disable transcoding in an Image pane directly:

Right-click the item, point to **Select stream**, and then click the desired menu command.

This setting only affects the selected Image pane.

This command does not affect the setting for the preferred stream in the Logical Tree.

Refer to

- *Options dialog box, page 139*
- *Image pane, page 144*

8.33

Using TCP for reliable connection

Main window > 

For each Video IP device from Bosch in your system you can establish a more reliable connection if required. This can be useful if you have for example connection losses due to high network load. You enable TCP for a selected camera to achieve a more reliable connection.

For all cameras of an entire workstation the system administrator can configure that the default protocol is TCP or UDP. For a single camera you can override the default protocol.

Note: From encoder firmware version 7.0, it is possible to display secure UDP for BVIP encoders. You can switch between TCP and UDP for live video of an encoder.

If you are using older firmware versions and the administrator activated the encryption for live video of an encoder in Configuration Client, TCP is selected by default and it is not possible to disable TCP.

To enable TCP:

- ▶ In the Logical Tree, right-click a camera and click **Enable TCP**.
- ⇒ The connection to the camera is now established via TCP. The context menu entry of this camera changes to **Disable TCP**.

To enable UDP:

- ▶ In the Logical Tree, right-click a camera and click **Disable TCP**.
- ⇒ The connection to the camera is now established via UDP. The context menu entry of this camera changes to **Enable TCP**.

To use the configured default protocol:

- ▶ In the Logical Tree, right-click a camera and click **Use default protocol (TCP)** or **Use default protocol (UDP)**. It depends on the current configuration which of these two menu commands is available.

8.34

Connecting to an unmanaged site

Main window

You can connect to an unmanaged site. All available devices of all video network devices of this site are then displayed in the Logical Tree. As soon as you log off or exit Operator Client, this connection is terminated.

To connect:

1. Right-click .
2. Click **Connect to Site**.

As long as the device is connecting,  is displayed.

After the connection is successfully established,  is displayed. All available devices of this site are displayed in the Logical Tree.

If not all devices belonging to this site can be connected,  is displayed. You can later try to connect the remaining devices that were not connected now.

Tip: You can also double-click  to connect.

To connect remaining devices:

1. Right-click .
2. Click **Retry Connection**.

To disconnect a single site:

1. Right-click  or .
2. Click **Disconnect from Site**.

The icon changes:



All Image panes with devices belonging to this site are automatically closed.

To disconnect all sites:

- ▶ Click .

All sites are disconnected. Partially connected sites are not disconnected.

All Image panes with devices belonging to this site are automatically closed.

Refer to

- *Unmanaged site, page 19*

8.35**Displaying a video analytics alarm**

Main window > 

You can display the analytics viewer application of the configured video analytics platform.

The analytics viewer application shows you analytics alarm details.

Prerequisites

- ▶ Drag the video analytics item  to an Image pane.
The default image of the analytics viewer application is displayed.

For displaying the analytics viewer application, a video analytics alarm must be available in the Alarm List.

To display the alarm viewer application:

- ▶ In the Alarm List, click to select a video analytics alarm.
The analytics viewer application is displayed in the Image pane where you dragged the video analytics item.

8.36**Displaying Intelligent Insights widgets**

Main window

You can display an Intelligent Insights widget in an image pane.

To display an Intelligent Insights widget in an image pane:

- ▶ Drag an Intelligent Insights widget from the **Logical tree** window to an image pane.
The Intelligent Insights widget is displayed in the image pane.

9 Using PTZ cameras



Notice!

This document describes some functions that are not available for BVMS Viewer. For detailed information about the different BVMS editions refer to www.boschsecurity.com and the BVMS Quick Selection Guide: [BVMS Quick Selection Guide](#).

This chapter provides information on how to use the **PTZ Control** window. Some of the features described in this chapter can be deactivated for your user group, your Enterprise User Group or your Enterprise Account.

9.1 Controlling PTZ cameras



Main window >  tab

You can zoom and control the cameras in the **PTZ Control** window or in the Image pane.



Notice!

When controlling a MIC 500 PTZ camera, focus near and focus far are permuted. You can switch the behavior directly on the device.

Controlling/zooming cameras in the PTZ Control window:

1. Select the required Image pane.
2. Click the various control elements in the **PTZ Control** window to control the camera.

To move to a preposition of a PTZ camera on a map:

1. Display a map containing a PTZ camera hot spot in an Image pane.
2. Right-click a PTZ camera located on a map, point to **Predefined positions**, and then click the desired preposition command.

The camera moves the focus to the selected preposition.

To lock the control of a PTZ camera on a map:

1. Display a map containing a PTZ camera hot spot in an Image pane.
2. Right-click a PTZ camera located on a map and click **Lock**.
The PTZ control of this camera is locked for other users.
3. To unlock: Right-click the locked PTZ camera and click **Unlock**.

Refer to

- *PTZ Control window, page 146*

9.2 Using in-window control of a PTZ camera

Main window

After you have assigned a PTZ camera to an Image pane, you can use the camera control functions directly in this Image pane.

To use the pan and tilt function:

1. Move the cursor on the Image pane which displays a PTZ camera.

The cursor changes to .

2. Press and hold the mouse button.

The cursor changes to .

To pan and tilt the image slowly, move the mouse slightly in the desired direction.

To pan and tilt more quickly, move the mouse further.

To use the optical zoom function:

- To zoom in, rotate the wheel button forward.
- To zoom out, rotate the wheel button backward.

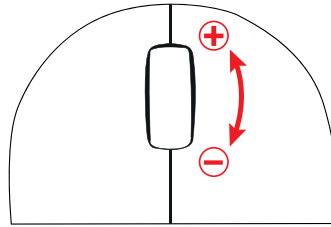

Refer to

- *Image pane, page 144*

9.3 Using the ROI function



Main window >  tab

You can use ROI with a fixed HD camera.

You can zoom and control the cameras in the **PTZ Control** window or in the Image pane.





Notice!

The system administrator must configure the ROI function in Configuration Client.

To use ROI:

1. Use the following PTZ controls:



2. Additionally you can use the digital zoom ( ). But this does not save network bandwidth.

Or

3. Use the in-window controls.

9.4 Using Intelligent Tracking



Main window >  tab

Intended use

Intended use of Intelligent Tracking is to enable a camera to follow a selected object. You can configure whether the selection of an object is automatically or manually. The camera can be a PTZ camera or a fixed HD camera (only with ROI enabled).

The following 3 modes are available:

- **Off:** Intelligent Tracking is turned off.
- **Auto:** Intelligent Tracking turned on, the largest object is automatically selected for tracking, recommended use: rarely moving objects in the image.
- **Click:** User selects object to be tracked.

After selecting the object to be tracked, a PTZ camera moves to follow the object until this object leaves the visible area of the camera or the operator stops tracking.

A fixed HD camera with the Intelligent Tracking feature enabled defines a surrounding region close to the borders of the selected object and zooms into the image to display only the region. Then the region is moved according to the movement of the object.

To use Intelligent Tracking:

1. Right-click the Image pane of the camera and click **Enable Content Analysis**.
 2. Click **Auto** or **Click** to enable Intelligent Tracking.
- ⇒ The camera follows an object that moves into the camera image.

10 Using maps, the global map and map viewports



Notice!

This document describes some functions that are not available for BVMS Viewer.

For detailed information about the different BVMS editions refer to www.boschsecurity.com and the BVMS Quick Selection Guide: [BVMS Quick Selection Guide](#).

This chapter provides information on how to use site maps, the **Map** window, the global map and map viewports.

Site maps

You can view a site map in the required ratio and zooming factor. Hence, you see all your devices and their places at a glance.

You can activate that the site map of the camera in the selected Image pane is automatically getting the focus. This site map is displayed in the **Map** window of the **Control** monitor.

Global map

You can see all your cameras that are configured on the global map. You can also search for cameras or locations. You can use the Map-based tracking assistant if the feature is enabled on the respective camera.

The Map-based tracking assistant helps you to track moving objects across multiple cameras. The respective cameras have to be configured on the global map. If an interesting moving object appears in live, playback, or in an alarm image pane, the user can start the Map-based tracking assistant that displays all nearby cameras automatically.

Map viewports

A map viewport is an area of the global map with a specific center and zoom level. You can still zoom in and out or move in any direction, but can also come back to the configured default position of the map viewport.

Some of the features described in this chapter can be deactivated for your user group, your Enterprise User Group or your Enterprise Account.

10.1 Displaying a site map

Main window

You can display a site map in the **Map** window or in an Image pane.



Notice!

A site map displayed in an alarm image pane is optimized for display and contains only the initial view of the original map file.

Depending on your configuration, a site map can display blinking and colored hot spots. Each hot spot indicates that a specific state change of the corresponding device has occurred.

To view a site map in the map window:

- ▶ Drag a map from the Logical Tree to the  tab, wait until the **Map** window is displayed, and drop the site map on the **Map** window. The site map is displayed.

To view a map in an Image pane:

- ▶ Drag a site map from the **Logical tree** window to an Image pane. The site map is displayed in the image pane.

Refer to

- *Map window, page 146*

10.2 Displaying a map viewport

Main window

You can display a map viewport in an Image pane.

To view a map viewport in an image pane:

- ▶ Drag a map viewport from the **Logical tree** window to an image pane.
The map viewport is displayed in the Image pane.

To go to the configured default position of a map viewport:

- ▶ After zooming in or out on a map viewport, click  to go back to the configured default position.

To search for cameras or locations in a map viewport:

1. Type the name of a camera, location or address in the search field.
As soon as you start typing a dropdown menu with a list of relevant options displays.
2. Select the respective option from the list

The camera, location or address displays and is indicated with a flag  for some seconds.

To display the live video preview of a camera:

- ▶ Mouse over the respective camera on the global map.

To change floors in map viewports:

1. Click .



The  field opens.

2. Select the respective floor.

10.3 Using the Map-based tracking assistant

The Map-based tracking assistant helps you to track moving objects across multiple cameras. The respective cameras have to be configured on the global map. If an interesting moving object appears in live, playback, or in an alarm image pane, the user can start the Map-based tracking assistant that displays all nearby cameras automatically.

If a camera is in instant playback mode or in playback mode and you start the Map-based tracking assistant, only the cameras that support playback are available in the Map-based tracking assistant display.

The Map-based tracking assistant displays five image panes: one main image pane and maximum four side image panes that are indicated by the Latin letters A-D.

The main image pane displays the selected main camera. The side image panes display the neighbor cameras, whose field of view overlap with the main cameras field of view or are closest by distance.

In the global map, the neighbor cameras are also indicated by the Latin letters A-D. When first starting the Map-based tracking assistant, those letters also display for some seconds in the respective image panes. The letters also display in the image pane bar, if enabled.

Note: To use the camera control functions, you have to select the respective image pane.

To start the Map-based tracking assistant

1. Select the image pane of the respective camera.

2. Click .

The **Map-based tracking assistant** display pops up.

The selected camera displays as main camera in the central image pane. The neighbor cameras display in the side image panes. The view cones of the neighbor cameras rotate automatically to the direction of the view cone of the main camera.

Note: If a neighbor camera is a PTZ camera, the actual view cone of the PTZ camera rotates automatically to the direction of the view cone of the main camera.

To display the live video preview of a camera:

- ▶ Mouse over the respective camera on the global map.

To reassign a main camera:

1. Double-click the hot spot of the respective camera.
The selected camera displays as main camera in the central image pane. The neighbor cameras reassign accordingly.
2. Double-click in the side image pane of the respective neighbor camera.
This former neighbor camera now displays as main camera in the central image page. The neighbor cameras reassign accordingly.
3. Double-click any location on the global map where you want to focus on.



The location is indicated with  for some seconds and the closest camera displays as main camera in the central image pane. The neighbor cameras reassign accordingly.

Note: If no camera view cone covers the selected location, the closest camera within a range of 80 meters automatically displays as main camera. If no camera view cone covers the selected location, and the closest camera is not within a range of 80 meters, no camera displays as main camera.

Start or stop First person view:

- ▶ Click .

When First person view is enabled, the global map rotates to align the view cone of the main camera to north orientation.

If the main camera is a dome camera, the global map rotates to align the actual view cone of the dome camera to north orientation.

Note: First person view is enabled by default when you start the Map-based tracking assistant.

To align the global map to default north orientation:

- ▶ Click .

The global map rotates to align to default north orientation.

Note: The First person view stops.

**Notice!**

When the default north orientation is enabled and you select a new main camera, the global map does not rotate to align the orientation of the camera view cone. If you want that behavior, you have to start First person view.

To stop the Map-based tracking assistant

1. When the **Map-based tracking assistant** display is enabled, click  to stop the Map-based tracking assistant.
You return to your previous mode (live mode, playback mode or alarm display).

Refer to

- *Map-based tracking assistant display, page 130*

11 Using favorites and bookmarks

This chapter provides information on how to use the Favorites Tree and the Bookmark Tree.

Favorites Tree

You can add every item of the Logical Tree to a view in the Favorites Tree to create your own subset of the Logical Tree. At any time you can display the view or add or delete devices in a view.

When saving a view in the Favorites Tree, you save the following settings:

- The assignment of cameras or other objects to Image panes
- The Image pane pattern
- The current setting of the digital zoom
- The image section
- The selected stream (only available for Live Mode)

Bookmark Tree

You can save a time period of live view or a recording in a bookmark. A bookmark saves a start and an end time, the cameras assigned to Image window at this time, and the entire Image pane pattern. A time period of 0 seconds is possible. Bookmarks are saved in the



pane. Deleting a bookmark does not affect the corresponding recordings. You cannot add or remove cameras from a bookmark. To change a bookmark, load it, make your changes and save it.

If a recording is deleted, the corresponding bookmark is not synchronized. If loaded, a black Image pane is displayed.

If you have logged on to an Enterprise Management Server, the camera name is displayed with the name of this camera's Management Server as a prefix.

Note: Do not add more than 4 cameras in one bookmark to avoid performance issues when loading the bookmark.



Notice!

This document describes some functions that are not available for BVMS Viewer.

For detailed information about the different BVMS editions refer to www.boschsecurity.com and the BVMS Quick Selection Guide: [BVMS Quick Selection Guide](#).

Refer to

- *Favorites Tree window, page 142*
- *Selecting live stream for display, page 51*

11.1 Adding items to the favorites tree



You can add each item of the Logical Tree to the Favorites Tree. This allows you to define your own subset of the Logical Tree.



To add an item:

- ▶ Right-click an item and click **Add To Favorites**.

Refer to

- *Logical Tree window, page 142*
- *Favorites Tree window, page 142*

11.2**Creating/editing views**

Main window >  >  tab
or

Main window >  >  tab

After having assigned cameras, maps, and HTML files to Image panes, you can save this assignment and the Image pane pattern in a view in the Favorites Tree.

To create a new view:

1. Arrange the cameras in the Image window in Live Mode and in Playback Mode.
2. If desired, use the digital zoom and select an image section.
When displaying a view, the live image of the camera is displayed in Live Mode and the recorded video of the camera is displayed in Playback Mode.
3. In the Image window toolbar, click .

A new view  is added. Enter a name for the new view.

Limitation for unmanaged sites: You can create a view of cameras from maximum 20 unmanaged sites.

To display a view:

- ▶ Double-click the view or right-click the view and click **Load Image pane view**.
The assignment saved in this view is displayed in the Image window.

Notice!

The maximum number of Image pane rows displayed in the Image window is configured in the BVMS Configuration Client. If this number has been changed since the last log off from Operator Client and the number of Image pane rows in the saved view exceeds the maximum set by system parameter, the saved view cannot be displayed and a warning is displayed.

You can display the view without the excess rows.

**Displaying a view for unmanaged sites**

When you load a view for cameras from unmanaged sites, the assignment saved in this view is displayed in the Image window and the unmanaged sites are connected automatically. If the connection takes more than 3 seconds the **Connecting** dialog box is displayed showing the connection progress.

- ▶ To cancel the connection process, click **Cancel**.
No further unmanaged sites are connected and no further camera images are loaded. The unmanaged sites which have already been connected remain connected and the camera images which have already been loaded remain open.

If there are connection problems, the unmanaged sites which could not be connected are displayed in the **Connecting** dialog box.

- ▶ After the connection process has finished, click **OK**.

If the number of already connected unmanaged sites and unmanaged sites assigned to the Favorite view exceeds the maximum number of 20 connected sites, a warning message is displayed.

- ▶ Click **No** to cancel.

Or

Click **OK** to continue.

If you continue, the unmanaged sites which are already connected but are not assigned to the Favorite view are disconnected and only unmanaged sites which are assigned to the Favorite view are connected.

To edit a view:

1. Double-click the view  which you want to edit.
2. Make the required changes, for example assign cameras to Image panes.
3. Right-click the required view and click **Update Image pane view**.

To rename a view:

1. Right-click the required view  and click **Rename**.
2. Enter the name of the view and press ENTER.

To delete a view:

- ▶ Right-click the view and click **Remove**.
The view is removed from the Favorites Tree.

Refer to

– *Favorites Tree window, page 142*

11.3 Exporting favorites settings

Main window >  >  tab
or

Main window >  >  tab

You can export any single favorites item, folder or the complete favorites tree. You can then share the exported file or files with other users.

To export favorites settings:

1. Right-click any favorites item, folder or the favorites tree root item, and select **Export**.
The **Export favorites** dialog box displays.
2. Type a password that supplies the minimum complexity requirements.
Or deselect the **Protect file with password** check box if protecting the export file is not required.

3. If required, select a folder and change the file name.
4. Click **Save**.

Note: The function is only active if the user has the respective permission.

11.4 Importing favorites settings

Main window >  >  tab
or

Main window >  >  tab

To import favorites settings:

1. Right-click any position in the favorites tree where you want to import favorites settings, and select **Import**.
The **Import favorites** dialog box displays.
2. Select the respective file and click **Open**.
3. If the file is protected, type the password and click **OK**.

Note: The function is only active if the user has the respective permission.

11.5 Adding a bookmark

Main window >  > Assign desired cameras to Image panes
or

Main window >  > Assign desired cameras to Image panes

To add a bookmark:

1. Using the Hairline, select the time period on the Timeline.
2. In the toolbar, click .
The **Add Bookmark** dialog box is displayed.
If you logged on to an Enterprise Management Server, the camera name is displayed with the name of this camera's Management Server as a prefix.
3. The selected time period is copied to the appropriate fields.
4. Make changes if required.
5. Click **OK**.
⇒ The bookmark is saved in the Bookmark Tree.

Add Bookmark dialog box

Name

Edit the name of the bookmark.

Start Time

In the lists, select date and time.

End Time

In the lists, select date and time.

Sources

Displays the cameras that belong to this bookmark.

11.6 Editing a bookmark

Main window >  >  tab
or

Main window >  >  tab

To edit a bookmark:

1. Right-click a bookmark and click **Edit bookmark**.
The **Edit bookmark** dialog box is displayed.
 2. Make changes if required.
 3. Click **OK**.
- ⇒ The bookmark is saved in the Bookmark Tree.

11.7 Loading a bookmark

Main window >  >  tab
or

Main window >  >  tab

To display a bookmark:

- ▶ Drag a bookmark to the Image window. The entire Image window layout saved in the bookmark is displayed in the Timeline. The Hairline is positioned at the start time of the bookmark.
- ⇒ The previous Image window is overwritten.



Notice!

The maximum number of Image pane rows displayed in the Image window is configured in the BVMS Configuration Client. If this number has been changed since the last log off from Operator Client and the number of Image pane rows in the saved bookmark exceeds the maximum set by system parameter, the saved view cannot be displayed and a warning is displayed.

You can display the view without the excess rows.

Refer to

- *Bookmarks window, page 143*

11.8 Exporting video of bookmarks

Main window > 
or

Main window > 

To export video of bookmarks:

1. Click the  tab.

2. Right-click a bookmark.
3. To export a single bookmark click **Export video of bookmark**.
The **Export video of bookmark** dialog box is displayed.
Or
To export multiple bookmarks click **Export video of multiple bookmarks**.
The **Export video of multiple bookmarks** dialog box is displayed.
4. Make the appropriate settings.
If you want to encrypt the exported files, type in a password and confirm this password.
5. Click **Export**.
The size of the recordings to be exported is estimated. Overlappings of recordings are subtracted. If free space is not enough, an error message is displayed.
The authenticity of the export is automatically verified.
The recordings are exported to the selected data medium.
6. If available, click **Verification Details** to display the **Authenticity Verification Result** dialog box. If no authentication issues were found, the **Verification Details** button is inactive.

**Notice!**

This document describes some functions that are not available for BVMS Viewer.
For detailed information about the different BVMS editions refer to www.boschsecurity.com and the BVMS Quick Selection Guide: [BVMS Quick Selection Guide](#).

Refer to

- *Authenticity verification result dialog box, page 79*
- *Timeline window, page 147*

11.8.1**Export video of bookmark dialog box**

Main window >  > Right-click a bookmark > **Export video of bookmark** command > **Export video of bookmark** dialog box

Allows you to export video data of a bookmark in native (BVMS Export Player), MP4 or MOV format. You can change the time period for the export. For each camera, a subfolder is created in the target folder. For detailed information on different export locations, refer to *Exporting video data, page 80*.

Name

If required, type a name for the exported file or keep the default name.

Start:

Displays the selected start time for exporting.

End:

Displays the selected end time for exporting.

Time before current playback time / Time after current playback time

Displays when there is at least one unsynchronized image pane in the bookmark and you did not select any time range. Enter the respective values. The values apply to all cameras in the exported bookmark.

Native

Click to select the BVMS Export Player format.

Select the **Include Export Player** dialog box, if you want to export the video together with the BVMS Export Player.

Include Export Player

When you export a video in native format, you can add the BVMS Export Player as a viewer. Click to select, if you want to include the BVMS Export Player.

MOV (Fast and compatible with Media Player)

Click to select the MOV format (compatible for example with QuickTime from Apple).

MP4 (Most commonly used to store video and audio)

Click to select the MP4 format (compatible for example with VLC media player or Windows Media Player).

Include audio

Click to select, if you want to include audio.

Add timestamp as subtitle

Select to add the timestamp as subtitle.

Privacy overlay

Select to add Privacy overlay to exported video for cameras that do not already have Privacy overlay enabled.

Note: Native and remote export are not supported for cameras with Privacy overlay.

Encrypt Export

Click to select encryption for this export.

Password

Type in a password for your encrypted export. Confirm this password in the **Confirm password** field.

Export as single ZIP file

Select to store the exported files in a single ZIP file. You use the ZIP file format to store all exported files in a single file, compression of the data is not available.

On a FAT32 partition, the maximum file size of the ZIP file is 4 GB.

Remote Export

Click to enable remote export. You can select a Management Server of your Enterprise System. On this Management Server the export is performed.

Ensure that the desired storage media is available.

Disk

Click **Browse** to select a hard disk partition for exporting.

CD/DVD/Blu-Ray

In the list, select a CD/DVD/Blu-Ray writer for exporting.

Not active when the **Remote Export** option is selected.

Finalize Disk

Click to select that the data medium is finalized after the successful burning process. After finalizing no further data can be burned on the data medium.

Comment:

Enter a comment for the export.

Refer to

- *Exporting video of bookmarks, page 67*
- *Providing a password for export, page 84*

11.8.2 Export video of multiple bookmarks dialog box

Main window >  tab > Right-click a bookmark > **Export video of multiple bookmarks** command > **Export video of multiple bookmarks** dialog box

Allows you to export video data of multiple bookmarks in native (BVMS Export Player), MP4 or MOV format. This way you can export different time periods of the same or different cameras in one process. For each camera, a subfolder is created in the target folder. For detailed information on different export locations, refer to *Exporting video data, page 80*.

Name

If required, type a name for the exported file or keep the default name.

Start:

Displays the selected start time for exporting.

End:

Displays the selected end time for exporting.

Time before current playback time / Time after current playback time

Displays when there is at least one unsynchronized image pane in the bookmark and you did not select any time range. Enter the respective values. The values apply to all cameras in the exported bookmark.

Native

Click to select the BVMS Export Player format.

Select the **Include Export Player** dialog box, if you want to export the video together with the BVMS Export Player.

Include Export Player

When you export a video in native format, you can add the BVMS Export Player as a viewer. Click to select, if you want to include the BVMS Export Player.

MOV (Fast and compatible with Media Player)

Click to select the MOV format (compatible for example with QuickTime from Apple).

MP4 (Most commonly used to store video and audio)

Click to select the MP4 format (compatible for example with VLC media player or Windows Media Player).

Include audio

Click to select, if you want to include audio.

Encrypt Export

Click to select encryption for this export.

Password

Type in a password for your encrypted export. Confirm this password in the **Confirm password** field.

Disk

Click to select a folder on a hard disk partition for exporting.

CD/DVD/Blu-Ray

In the list, select a writer device for exporting.

Enable **Finalize Disk**, if you do not want to burn further data on the data medium.

Bookmarks

In the list, select the bookmarks that you want to export.

Finalize Disk

Click to select that the data medium is finalized after the successful burning process. After finalizing no further data can be burned on the data medium.

Comment:

Enter a comment for the export.

Export as single ZIP file

Select to store the exported files in a single ZIP file. You use the ZIP file format to store all exported files in a single file, compression of the data is not available.

On a FAT32 partition, the maximum file size of the ZIP file is 4 GB.

Add timestamp as subtitle

Select to add the timestamp as subtitle.

Privacy overlay

Select to add Privacy overlay to exported video for cameras that do not already have Privacy overlay enabled.



Note: Native and remote export are not supported for cameras with Privacy overlay.

Refer to

- *Exporting video of bookmarks, page 67*
- *Providing a password for export, page 84*

11.9

Exporting bookmark settings

Main window >  >  tab
or

Main window >  >  tab

You can export any bookmark item, folder or the complete bookmark tree and share the exported file or various files with other users.



To export bookmark settings:

1. Right-click any bookmark item, folder or the bookmark tree root item, and select **Export bookmark settings**.
The **Export bookmark settings** dialog box displays.
2. Type a password that supplies the minimum complexity requirements.
Or deselect the **Protect file with password** check box if protecting the export file is not required.
3. If required, select a folder and change the file name.
4. Click **Save**.

Note: The function is only active if the user has the respective permission.

11.10

Importing bookmark settings

Main window >  >  tab
or

Main window >  >  tab

To import a bookmark tree:

1. Right-click any position in the bookmark tree where you want to import bookmark settings, and select **Import bookmark settings**.
The **Import bookmark settings** dialog box displays.
2. Select the respective file and click **Open**.
3. If the file is protected, type the password and click **OK**.

Note: The function is only active if the user has the respective permission.

12 Managing recorded videos

This chapter provides information on how to manage recordings. Some of the features described in this chapter can be deactivated for your user group.



Notice!

This document describes some functions that are not available for BVMS Viewer. For detailed information about the different BVMS editions refer to www.boschsecurity.com and the BVMS Quick Selection Guide: [BVMS Quick Selection Guide](#).

12.1 Selecting a time zone

Main window



Notice!

Ensure that the time on all computers of your system is set correctly according to each time zone where the computers are located.

Management Server or unmanaged site and all connected devices including encoders, decoders, VRM Server computers, and DVR devices must be in the same time zone. Operator Client computers (including Client SDK and Cameo SDK) and Configuration Client computers can be in other time zones than the Management Server or unmanaged site.

If your Operator Client is located in another time zone than one or more connected Management Server or unmanaged site, you can select one of the following time displays:

- Your local time
 - UTC
 - Time zone of the Management Server or unmanaged site you are connected to
- The Image panes displaying a camera (live and playback) always show the time of the corresponding Management Server or unmanaged site.

In the Logical Tree,  is displayed on the device icon of each server or unmanaged site that do not share the time zone that is currently selected in the Operator Client:

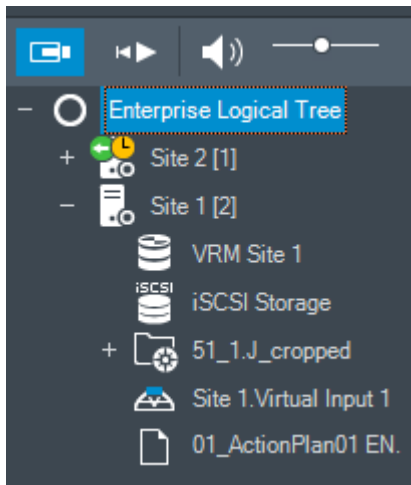

You can select the time zone of a server or unmanaged site for displaying this time zone in Operator Client.

To select the time zone:

1. In the Logical Tree, right-click a server icon to select the time zone of this server.
2. In the time zone selector list, select the desired entry.
 - **Operator Client Time:** Operator Client

- **UTC**
- **UTC-x**: time zone of each available Management Server

The time based on the selected time zone is displayed in the menu bar:

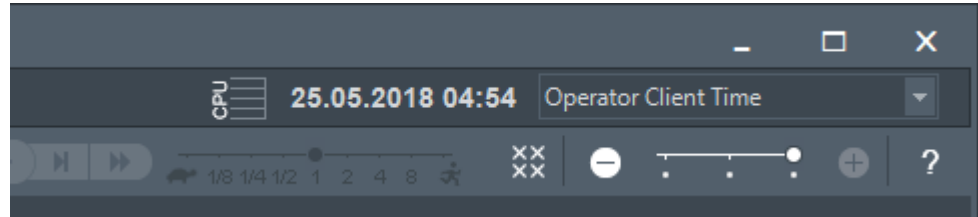

Refer to



- *Logical Tree window, page 142*

12.2

Finding recorded video

Main window >  >  > Click  > **Timeline search** entry > **Timeline search** dialog box
or

Main window >  >  >  > **Video by event search** entry > **Select Search Parameters** dialog box
or

Main window >  >  > Click  > **Please select a Server** entry > **Search for Text Data** dialog box

To find video data:

1. Click somewhere in the timeline.
2. Drag to move the timeline window to the right or to the left to select a time period.

3. Click  to select the respective search type entry.
4. Enter or select the required search criteria.
5. Click **Search**.

The  window with the matching entries is displayed.

6. For playing the corresponding video, double-click the entry. The corresponding video is displayed.

If you searched for text data, the text data pane is automatically opened in the Image pane.

Refer to

- *Select Search Parameters dialog box, page 91*
- *Logbook Results: dialog box, page 93*
- *Timeline window, page 147*
- *Using the timeline, page 75*
- *Displaying text data, page 94*
- *Searching for text data, page 95*

12.2.1 Video Search Results window

Main window >  >  tab

Displays entries for video data matching different search criteria. You can select an entry for playback, protection, authenticity checking, archiving, or export.

Allows you to play the recordings that match the search criteria.

12.3 Playing recorded videos

Main window >  >  tab

Note:

Bosch Allegiant cameras are not recorded within BVMS.

To play recorded videos:

1. Assign a camera to an Image pane.
2. Switch to the desired recording source if available.
3. Use a Timeline control for the required playing option.

Refer to

- *Timeline window, page 147*
- *Using the timeline, page 75*
- *Switching the recording source, page 99*

12.4 Using the timeline

Main window >  >  tab

You can access a specific time in the timeline via the hairline.

To navigate in the timeline:

1. Click somewhere in the timeline.
The images of the selected point in time are displayed in the image window.
2. Scroll to zoom in and out.
3. Drag to move the timeline window to the right or to the left.
4. To edit the values, click on the time label of the hairline.

5. Click .

The Hairline jumps to this time. The images of the entered point in time are displayed in the image window. Use a timeline control for the required playing option.

You can select a time period in the timeline using the hairline. You can use this selection for further tasks such as for exporting video data.

- ▶ Drag the bottom handles of the Hairline to select a time period or to change this selection.

Drag the upper handles to move the hairline or selection.

Refer to

- *Timeline window, page 147*
- *Playing recorded videos, page 75*

12.5 Changing the playback speed



Main window > > tab >

To change the playback speed for playing a video forward or reverse:

- ▶ Move the slider to the left to decrease the playback speed, and to the right to increase the playback speed.

Note: If you set the playback speed to 4x or higher, not all frames will be displayed.

Refer to

- *Timeline window, page 147*

12.6 Restricting or unrestricting video



Main window >

You can restrict (or unrestrict) the recordings of connected cameras.

When restricted, an unauthorized user cannot display the recordings of these cameras.

For restricting and unrestricting you need the corresponding permission.



Notice!

Unrestricting / unprotecting a selected time period can possibly unrestrict / unprotect the entire contiguous restricted / protected time period of this camera, even outside the selected time period.

To open the Restrict / unrestrict time period dialog box from the logical tree:

1. In the logical tree, right-click the respective camera.
2. Click **Recordings**.
3. Click **Restrict / unrestrict**.
The **Restrict / unrestrict time period** dialog box is displayed.
4. If needed, select the recording type (primary or secondary recording).

To open the Restrict / unrestrict time period dialog box using the hairline:



1. From the **tab**, select the time period of one or more cameras on the timeline.
2. To edit the values, click on the time label of the hairline.
3. Right-click this time period and click **Restrict / unrestrict**.
The **Restrict / unrestrict time period** dialog box is displayed.

Restrict / unrestrict time period dialog:

1. If needed, adjust the start and end time.
2. Select the cameras or deselect the cameras you do not need.
3. Click **Restrict / unrestrict** to restrict or unrestrict video.
4. To interrupt the process click **Cancel** or the **X** button.
5. When the process is finished, the action is displayed in the operation state column.
6. Click the **X** button.
The action is displayed in the timeline.

In the timeline, restricted video is indicated with dark grey diagonal stripes: 

12.7 Protecting or unprotecting video

Main window > 

You can protect the images of the displayed cameras against being overwritten or deleted.



Notice!

You cannot protect the data of a local storage device.



Notice!

Unrestricting / unprotecting a selected time period can possibly unrestrict / unprotect the entire contiguous restricted / protected time period of this camera, even outside the selected time period.



Notice!

If you protect the alarm recording of a camera, the protected video data will never be deleted by the VRM automatically. Be aware that too many protected blocks can fill up the storage and the camera may stop recording. You have to manually unprotect the video data in the Operator Client.

To open the Protect / unprotect time period dialog box from the logical tree:

1. In the logical tree, right-click the respective camera.
2. Click **Recording**.
3. Click **Protect / unprotect**.
The **Protect / unprotect time period** dialog box is displayed.
4. If needed, select the recording type (primary or secondary recording).

To open the Protect / unprotect time period dialog box using the hairline:



1. From the  tab, select the time period on the timeline.
2. To edit the values, click on the time label of the hairline.
3. Right-click this time period and click **Protect / unprotect**.
Protect / unprotect time period dialog box is displayed.

Protect / unprotect time period dialog:

1. If needed, adjust the start and end time.
2. Select the cameras or deselect the cameras you do not need.
3. Click **Protect** to protect video or **Unprotect** to unprotect video.
4. To interrupt the process click **Cancel** or the **X** button.
5. When the process is finished, the action is displayed in the operation state column.
6. Click the **X** button.
The action is displayed in the timeline.

In the timeline, protected video is indicated with dark grey diagonal stripes: 

Refer to

- *Timeline window, page 147*

12.8 Deleting video data

Main window > 

You can delete video data from the beginning of the recording to the position of the hairline. The video data of all cameras available in the timeline is deleted.

VRM recordings: Protected recordings are not deleted.



Notice!

You cannot restore deleted video data.



Notice!

You cannot delete the data of a local storage device.

To open the Delete time period dialog box from the logical tree:

1. In the logical tree, right-click the respective camera.
2. Click **Recordings**
3. Click **Delete**.
4. Confirm the warning message.
The **Delete time period** dialog box is displayed.
5. If needed, select the recording type (primary or secondary recording).

To open the Delete time period dialog box using the hairline:



1. From the  tab, select the time period on the timeline.
2. To edit the values, click on the time label of the hairline.
3. Right-click this time period and click **Delete**.
4. Confirm the warning message.
The **Delete time period** dialog box is displayed.

Delete time period dialog:

1. If needed, adjust the start and end time.
2. Select the cameras or deselect the cameras you do not need.
3. Click **Delete**.
4. To interrupt the process click **Cancel** or the **X** button.
5. When the process is finished, the action is displayed in the operation state column.
6. Click the **X** button.
The action is displayed in the timeline.

Refer to

– *Timeline window, page 147*

12.9 Verifying the authenticity of video data

Main window >  >  tab
or

You can verify the authenticity of the recordings of all cameras displayed in the image window.

To authenticate:

1. Using the hairline, select the time period on the timeline.
2. To edit the values, click on the time label of the hairline.
3. Right-click this time period and click **Verify authenticity...**
The **Verify Authenticity** dialog box with a progress bar is displayed.
4. To interrupt the process click **Cancel** or the **X** button.
5. When the authentication is finished, the **Authenticity Verification Result** dialog box is displayed and shows the result of the verification process.

12.9.1

Authenticity verification result dialog box

Main window > **Unrestrict video...** menu > **Verify authenticity...** command > **Verify Authenticity** dialog box > **Verify** button > **Authenticity Verification Result** dialog box
or

Main window >  > **Unrestrict video...** menu > **Export video...** command > **Export** dialog box > **Verification Details** button > **Authenticity Verification Result** dialog box
or

Main window >  > **Unrestrict video...** menu > **Verify authenticity...** command > **Verify Authenticity** dialog box > **Verify** button > **Authenticity Verification Result** dialog box
or

Main window > **Unrestrict video...** menu > **Export video...** command > **Export** dialog box > **Verification Details** button > **Authenticity Verification Result** dialog box
or

Main window >  > Right-click a bookmark > **Export video of bookmark** command > **Export video of bookmark** dialog box > **Verification Details** button > **Authenticity Verification Result** dialog box
or

Main window >  tab > Right-click a bookmark > **Export video of multiple bookmarks** command > **Export** dialog box > **Verification Details** button > **Authenticity Verification Result** dialog box

Allows you to view the results of an authenticity verification of a selected time period of recorded video. You can save the results in a CSV file.

Created on

Displays the date when the authenticity verification was performed.

By

Displays the name of the user who started the authenticity verification.

Time range

Displays the time period to be verified that was selected by the user.

Summary

Displays the number of cameras which recordings have been verified, and the results.

Details

Click to display detailed information on the authenticity verification.

Authentic

Displays an authentic result. The icon is explained in the summary.

Camera

Displays the camera that was verified.

Date / Time

Displays the authentic time period.

More Information

Displays detailed information on the certificate.

CSV Export

Displays a dialog box to enter path and filename for the authenticity verification report.

Authenticity Verification Result

Created on: 25.05.2018 04:45:33
By: admin

Time range: 25.05.2018 03:55:35 - 25.05.2018 04:00:24
Summary: Recording of 1 camera checked

— 0 time spans verified to be authentic.

Details

Authentic	Camera	Date / Time	More Information

CSV Export Close

Refer to

- *Exporting video of bookmarks, page 67*
- *Exporting video data, page 80*

12.10**Exporting video data**

Main window >

**Notice!**

You cannot export the data of a local storage device.

You can export video and audio data in native (BVMS Export Player), MP4 or in MOV format. For each exported camera, a subfolder is created in the target folder. The data can be exported to:

- a local drive
- a CD/DVD or Blu-Ray disk
- a network drive
- a USB drive

Note: Use a fast USB drive to avoid failures.

In an Enterprise System: you can select a remote Management Server to perform the export there. You can only export the recordings of the cameras that are managed by the selected Management Server.

Only one export at a time can run on a workstation.

Note: You need a permission for each camera you want to export.



Notice!

Remote exports are only possible to a USB drive, CD, DVD or Blu-Ray disk.

Export in native format

The table describes the differences between an unencrypted and an encrypted export of video data in native format.

Criteria	Unencrypted export	Encrypted export
Password protected	No	Yes
File extension	.info	.encr
User cancels the export process	All video data of the current export is deleted.	All video data of the current export is deleted.
Export was not successful	If multiple cameras are exported, all successful exports are saved. The unsuccessful export is deleted.	All video data of the current export is deleted.

Export on multiple disks

Encrypted exports and exports into a single ZIP file are not possible on multiple CDs/DVDs/Blu-Ray disks. If the export fits on a single CD/DVD/Blu-Ray disk, encrypted export on a CD/DVD/Blu-Ray disk is possible.

Recordings that were selected for export and exported to CD/DVD/Blu-Ray disks, are first written to the local hard drive and then written to one or more writeable disks.

Unencrypted export on multiple disks is only supported for native format. Exporting with MP4 or MOV format only works when it fits on one disk.

The first inserted disk determines the media type of all following disks.

If recordings were exported to multiple CD/DVD/Blu-Ray disks, and you must view all exported cameras in all exported time periods, copy the content of all disks to your hard drive. You can ignore all occurring overwrite warnings.

You can view the recordings exported to a single disk out of a group of disks that were created during an export.

If exporting video data on a CD/DVD/Blu-Ray disk was not successful or the user cancels the export, the already exported video data of this export process is retained.

When the verification of authenticity is enabled in Configuration Client, each export is automatically checked.

Export of a panoramic camera

When you export the recordings of a panoramic camera you always export the full image circle. If you export multiple cropped Image panes of the same panoramic camera, the full image circle of this camera is exported only once. This also applies for the export of non-panoramic cameras.



Refer to

- *Export video of bookmark dialog box, page 68*
- *Export video of multiple bookmarks dialog box, page 70*
- *Export Video dialog box, page 84*
- *Timeline window, page 147*
- *Video Search Results window, page 75*
- *Authenticity verification result dialog box, page 79*

12.10.1 Exporting a time period

Main window > 

To export a time period:

1. Click the  tab.
2. Using the hairline, select the time period on the timeline.
3. To edit the values, click on the time label of the hairline.
4. Click .

The **Export** dialog box is displayed.
5. Make the appropriate settings.

If you want to encrypt the exported files, type in a password and confirm this password.
6. Click **Export**.

The size of the recordings to be exported is estimated. Overlappings of recordings are subtracted. If there is not enough free space, an error message is displayed.

The authenticity of the export is automatically verified.

The files are exported to the selected data medium.
7. If available, click **Verification Details** to display the **Authenticity Verification Result** dialog box.

Note:

- If an operator has no permission to see restricted video and exports a restricted time period:
 - The file exports with empty time ranges.
 - Multiple files are produced.

12.10.2 Exporting a single search entry

Main window > 

To export a single search entry:

1. Perform a search for video data.



2. Click the  tab.
3. Click an entry in the search result list.



4. Click the  tab.



5. Click  .
The **Export** dialog box is displayed.

6. Make the appropriate settings.

If you want to encrypt the exported files, type in a password and confirm this password.

7. Click **Export**.

The authenticity of the export is automatically verified.

The entry is exported to the selected data medium.

8. If available, click **Verification Details** to display the **Authenticity Verification Result** dialog box.

12.10.3**Exporting into a single file**

Main window >

You can export video recordings into a single ZIP file.

To export into a single file:

1. Click the  tab.
2. Using the hairline, select the time period on the timeline.
3. To edit the values, click on the time label of the hairline.
4. Click to select **Export as single ZIP file**.
5. Make the appropriate settings.
If you want to encrypt the exported files, type in a password and confirm this password.
6. Click **Export**.
The size of the recordings to be exported is estimated. If free space is not enough, an error message is displayed.
The authenticity of the export is automatically verified.
The recordings are exported and the export is added to a single ZIP file.
7. If available, click **Verification Details** to display the **Authenticity Verification Result** dialog box.

**Notice!**

You cannot load a ZIP export file in Operator Client.

Refer to

- *Export Video dialog box, page 84*

12.10.4 Providing a password for export

Main window >  > **Timeline** menu > **Export video...** command > **Export** dialog box
or

Main window >  > Right-click a bookmark > **Export video of bookmark** command > **Export video of bookmark** dialog box
or

Main window >  tab > Right-click a bookmark > **Export video of multiple bookmarks** command > **Export video of multiple bookmarks** dialog box

You can provide a password for each native export that you perform using Operator Client.

To provide a password:

1. Click to select **Native format**.
2. Click to select **Encrypt Export**.
3. Type in a password and confirm it.
4. Make the appropriate settings.
5. Click **Export**.

The encrypted export is performed.

When loading this export, the operator must type in the password.

Refer to

- *Export video of bookmark dialog box, page 68*
- *Export video of multiple bookmarks dialog box, page 70*
- *Export Video dialog box, page 84*

12.10.5 Export Video dialog box





Notice!

This document describes some functions that are not available for BVMS Viewer.

For detailed information about the different BVMS editions refer to www.boschsecurity.com and the BVMS Quick Selection Guide: [BVMS Quick Selection Guide](#).

Main window >  > **Timeline** menu > **Export video...** command > **Export** dialog box
or

Main window >  >  **Timeline** window > **Export** context menu or  **Export video** button

Name

If required, type a name for the exported file or keep the default name.

Start:

Displays the selected start time for exporting.

End:

Displays the selected end time for exporting.

Native

Click to select the BVMS Export Player format.

Select the **Include Export Player** dialog box, if you want to export the video together with the BVMS Export Player.

Include Export Player

When you export a video in native format, you can add the BVMS Export Player as a viewer. Click to select, if you want to include the BVMS Export Player.

Encrypt Export

Click to select encryption for this export.

Password

Type in a password for your encrypted export. Confirm this password in the **Confirm password** field.

MOV (Fast and compatible with Media Player)

Click to select the MOV format (compatible for example with QuickTime from Apple).

MP4 (Most commonly used to store video and audio)

Click to select the MP4 format (compatible for example with VLC media player or Windows Media Player).

Include audio

Click to select, if you want to include audio.

Add timestamp as subtitle

Select to add the timestamp as subtitle.

Privacy overlay

Select to add Privacy overlay to exported video for cameras that do not already have Privacy overlay enabled.

Note: Native and remote export are not supported for cameras with Privacy overlay.

Export as single ZIP file

Select to store the exported files in a single ZIP file. You use the ZIP file format to store all exported files in a single file, compression of the data is not available.

On a FAT32 partition, the maximum file size of the ZIP file is 4 GB.

Remote Export

Click to enable remote export. You can select a Management Server of your Enterprise System. On this Management Server the export is performed.

Ensure that the desired storage media is available.

Disk

Click **Browse** to select a hard disk partition for exporting.

Split size

Allows you to configure the split size of the exported video in order to adapt the splitted chunks to fit your storage media. This configuration is only available for non-native formats.

Note: The value is an approximate value. The exported video is splitted in, for example, full frames or blocks. Because of that the size of the exported chunks does not correspond exactly to the same value that you configure.

CD/DVD/Blu-Ray

In the list, select a CD/DVD/Blu-Ray writer for exporting.

Not active when the **Remote Export** option is selected.

Finalize Disk

Click to select that the data medium is finalized after the successful burning process. After finalizing no further data can be burned on the data medium.

Comment:

Enter a comment for the export.

Cancel

Click to save the dialog settings until you start Operator Client the next time.

Refer to

- *Exporting video data, page 80*
- *Providing a password for export, page 84*
- *Exporting into a single file, page 83*

12.10.6**Export dialog box**

Main window >  > **Unrestrict video...** menu > **Export video...** command > **Export** dialog box > **Export** button > **Export** dialog box
or
or

Main window >  tab > Right-click a bookmark > **Export video of multiple bookmarks** command > **Export** dialog box > **Export** button > **Export** dialog box
or

Main window >  > Right-click a bookmark > **Export video of bookmark** command > **Export** dialog box > **Export** button > **Export** dialog box

Allows you to view information on the performed export and to display the results of the authenticity verification that is automatically performed on every export.

Verification Details

Click to display the **Authenticity Verification Result** dialog box.

This button is only available if authentication issues were found.

Refer to

- *Exporting video data, page 80*
- *Exporting into a single file, page 83*

12.11**Loading exported video**

Main window > 

**Notice!**

You cannot load a ZIP export file in Operator Client.

Export formats

- Block exports (info), created with the VRM eXport Wizard
- Not encrypted Export files (*.info), created with the BVMS Operator Client
- Encrypted Export files (*.encr) , created with the BVMS Operator Client
- Export files (*.mp4), created with BVC

Additional Information

Video exports created with the VRM eXport Wizard are displayed as `info` file.

With the VRM eXport Wizard it is possible to export a large volume of data.

The VRM eXport Wizard is part of the BVMS release ZIP within the folder Bonus. For more information see the VRM eXport Wizard Software Manual.

You can load exported recordings for display. Before you can load an export which was exported into a single ZIP file, extract this ZIP file.

1. On the **Unrestrict video...** menu, click the **Load exported video...** command. The dialog box for opening export files is displayed.
2. Select the required file and click **Open**.
Encrypted export files have the `.encr` extension, not encrypted files have the `.info` extension, block exports are displayed as `info` file.
If you select a file with the `.encr` extension, type in the password for this export.

The loaded video is displayed in the  window.

For playing the loaded video, expand the entry and drag a camera to an Image pane. If the camera has been exported on a computer where Operator Client was logged on to an Enterprise Management Server, the camera name is displayed with the name of this camera's Management Server as a prefix.

The Export Tree entries are removed when you exit the Operator Client.

3. For removing the exported video, right-click  and click **Unload Export**.

Refer to

- *Exports window, page 145*
- *Timeline window, page 147*

12.12 Enabling video content analysis (VCA)

Main window
or
alarm image window

To enable:

- ▶ Right-click an Image pane or alarm image pane with a camera assigned and click **Enable Content Analysis**.
The VCA overlays are displayed.

To disable:

- ▶ Right-click an Image pane or alarm image pane with a camera assigned and click **Disable Content Analysis**.
The VCA overlays disappear.

This setting is retained after the next restart or re-logout of Operator Client, after closing the camera and displaying it again in an Image pane, or after an alarm with the assigned camera is triggered again.

12.13 Performing a Forensic Search

Main window >  > Select an image pane >  tab

Forensic Search allows you to search for specific properties in the video of the selected image pane. IVA-based Forensic Search is only available for VRM, local storage, block exports and Bosch Video Client recordings.

To perform a Forensic Search:

1. Select the image pane where you want to find motion and where Forensic Search is configured.
2. Using the Hairline, select the time period on the timeline.
3. Select the  tab.
4. In the **Search mode** list, select the appropriate entry.
5. In the **Type** list, select the appropriate entry.
6. Configure your Forensic Search.
7. Click **Search** to start the Forensic Search.

The  symbol displays that the Forensic Search was successfully performed.

8. Select the  tab to find a list of the matching entries.
9. For playing the corresponding video, double-click the entry.
The corresponding video is displayed.

To configure a Forensic Search:

1. Select the respective image pane.
2. Select the  tab.
3. Select a mode in the **Search mode** list, for example **Individual camera search**.
4. If applicable, select a preset.
Note: The preset **<auto saved>** loads the previously configured tasks.
5. Select a type from the **Type** list, for example **Video Analytics**.
6. Select the **Tasks** tab.

7. Click  to add a new task.
8. Select a task, for example **Object in field**.

9. Click  .

10. Define the task and click  to finish.



The  symbol displays that a Forensic Search is now configured.

To configure Motion+:

1. Drag an area to select the cells you want to check for motion.
The selected area is displayed in transparent yellow.
2. To clear a selected area, right-click the selected area and click **Clear All**.

To edit an existing task:

1. Select the task you want to edit.

2. Click  .
3. Make the appropriate changes.
4. Click  .

Forensic Search window

Allows you to find video data with selecting a Forensic Search type, for example MOTION+.

Search mode

Select the required search mode.

Individual camera search

Perform a Forensic Search individually for a selected image pane.

Note: If more than one open image pane have Forensic Search configured, the search applies to all of them according to their individual search configuration.

Common camera search

Perform a Forensic Search by applying the search configuration of a selected image pane to all other open image panes.

Presets

Select an entry to load settings that you have saved.

Note: The latest configured settings are always saved automatically. You can load them when you select the entry **<auto saved>**.

Click  to save your configured preset settings. You can enter a descriptive name.

Note: The unsaved preset settings are only available as long as the camera is open. If you close and reopen it, the configuration is saved as **<auto saved>**.

Type

Select the required analysis type, for example:

- Intelligent Video Analytics
- MOTION+

Note: If you select one of these algorithms, you can set the corresponding parameters directly.

Tasks

Configure your Forensic Search. See the user documentation of the Intelligent Video Analytics version that you are using.

Metadata Inspection

See object properties of selected objects in the image pane and use these properties to refine your Forensic Search criteria in order to get better results.

Search

Click to start the Forensic Search.

For detailed information on video analysis, see the documentation for Video Content Analysis VCA.

Refer to

- *Timeline window, page 147*

12.14 Forensic Search Results window

Main window >  tab

Displays entries for video data containing motion for the camera displayed in the selected Image pane. You can select an entry for playback, protection, authenticity checking, archiving, or export.

Displays the recordings that match the search criteria.

Refer to

- *Performing a Forensic Search, page 87*
- *Exporting video data, page 80*

12.15 Finding logbook entries

Main window > **Tools** menu > **Find in logbook...** command > **Please select a Server** dialog box (if required) > **Select Search Parameters** dialog box

In the Logbook, you can search for particular events, alarms, devices, and strings of events. You can save the search criteria as a filter. If you select another time zone, the date and time display of the Logbook search results is changed accordingly.

To find Logbook entries:

1. In an Enterprise System, select the desired Management Server for searching.
2. In the **Filter** list, select a pre-defined filter if available.
A filter contains all the settings that you make in this dialog box.
You can save, load, and delete the selected filter. You can reset the settings of the selected filter.
3. In the **Date and Time** field, enter start date and time and end date and time for the search process.
4. In the **Result Count** list, limit the number of matching entries that result from the search.
5. Click **Add** to limit the search to specific events.
6. Click **Add/Edit** to specify search criteria for text data.
7. In the **Alarms** field, select search criteria to limit the search to specific alarms.
8. Click **Add** to limit the search to specific devices.
9. In the **Details** field, type a search string. You can use * as a wildcard.
10. In the **User name** field, type a user name to search for.
11. Click **Search**.

The **Logbook results:** dialog box with the matching entries is displayed.

Refer to

- *Select Search Parameters dialog box, page 91*
- *Logbook Results: dialog box, page 93*
- *Search Conditions dialog box, page 93*
- *Device Selection dialog box, page 93*
- *Event Selection dialog box, page 93*

12.15.1 Finding logons to an unmanaged site

Main window > **Tools** menu > **Find in logbook...** command > **Please select a Server** dialog box (if required) > **Select Search Parameters** dialog box

You can find a logon event on a workstation that is configured in another BVMS as an unmanaged site. If a user of Operator Client accesses this workstation using an unmanaged site, this event is logged as an **Operator Logon** event.

To find a logon:

1. Click **Add** to limit the search to specific events.
2. In the **Event Selection** dialog box, expand **Events and Alarms**, expand **System Devices**, expand **User Actions**.
3. Click to select **Operator Logon** and **Operator Logoff**.
4. Click **Search**.

The **Logbook results:** dialog box with the matching entries is displayed.

12.15.2

Please select a Server

Main window > **Tools** menu > **Please select a Server** command

This dialog box only appears when you logged on as user of an Enterprise User Group. Allows you to select a Management Server where the Logbook search is performed.

Management Server:



Select the IP address of the desired Management Server.

12.15.3

Select Search Parameters dialog box

Main window > **Tools** menu > **Find in logbook...** command > **Please select a Server** dialog box (if required)

or

Main window >  >  > **Video by event search** entry

Allows you to define and save search criteria for finding entries in the logbook. If you start this dialog box from within the playback mode via **Tools** menu, the time period selected in the **Timeline** window is copied into the **Date and Time** fields.

If you start this dialog box via **Video by event search**, the search for text data is not supported. If you start via the **Find in logbook...** command, text search is supported.

If you start this dialog box via **Video by event search**, the cameras of the current image window are preselected for the search and the Management Server of the camera displayed in the selected Image pane is preselected. If no camera is displayed in the Image window, the first Management Server of the logical tree is preselected.

If you select another time zone, the date and time display of the logbook search results is changed accordingly.

Filter

Select a filter name with predefined search criteria or type a name for a new filter.

Delete

Click to remove the entry selected in the **Filter** list.

Load

Click to load the search criteria of the selected filter name.

Save

Click to save the search criteria with the selected filter name.

Reset

Click to clear all search criteria of the selected filter name.

Date and Time

Type the date and time to define the period you want to search.

Result Count

Select an entry in the list to limit the number of matches that result from the search.

Add

Click to display the **Event Selection** dialog box.

Remove

Click to remove a selected event entry.

Remove All

Click to remove all event entries.

Add/Edit

Click to display the **Search Conditions** dialog box.

Remove

Click to remove the selected condition entry.

Remove All

Click to remove all condition entries.

Alarm priority

Select an alarm priority to search for.

Alarm State

Select an alarm state to search for.

Record only

Click to select for searching record-only alarms.

Force workflow

Click to select for searching force workflow alarms.

Auto clear

Click to select for searching auto-clear alarms.

Add

Click to display the **Device Selection** dialog box.

Remove

Click to remove a selected device entry.

Remove All

Click to remove all device entries.

Details

Type a string to search for. Some important events contain strings to better find them. For example, a particular SystemErrorEvent has the string **Server alarm queue capacity reached!**. You can use * as a wildcard. For example, enter *triggered* to find the string An alarm was triggered by a network failure.*triggered or triggered* will not find this string.

User name

Type a user name to search for.

Search

Click to start the search. The **Logbook results:** dialog box is displayed.

Close

Click to close the dialog box. No search is executed. If you did not save your search criteria with a filter name, they get lost.

Refer to

– *Finding recorded video, page 74*

12.15.4

Event Selection dialog box

Main window > **Tools** menu > **Find in logbook...** command > **Select Search Parameters** dialog box > **Add** button

Allows you to add events for filtering purposes.

Refer to

- *Finding recorded video, page 74*

12.15.5

Device Selection dialog box

Main window > **Tools** menu > **Find in logbook...** command > **Select Search Parameters** dialog box > **Add** button

Allows you to select the appropriate devices for finding Logbook entries and recorded videos.

Refer to

- *Finding recorded video, page 74*
- *Finding logbook entries, page 90*
- *Select Search Parameters dialog box, page 91*

12.15.6

Search Conditions dialog box

Main window > **Tools** menu > **Find in logbook...** command > **Select Search Parameters** dialog box > **Add/Edit** button

You can combine multiple values of different text data entries to find the desired Logbook entry. For example, you combine a bank routing code with a date to find the respective Logbook entries.

Add Condition

Click to add a new entry in the **Data Field Name** column.

In the list of available data values, select the desired entry.

In the **Comparative Value** column, type in a search string.

Repeat these steps for further data values.

Remove Condition

Click to remove the selected entry.

Remove All

Click to remove all entries.

Refer to

- *Select Search Parameters dialog box, page 91*
- *Finding logbook entries, page 90*

12.15.7

Logbook Results: dialog box

Main window > **Tools** menu > **Find in logbook...** command > **Select Search Parameters** dialog box > **Search** button

Displays the results of a Logbook search. If you select another time zone, the date and time display of the Logbook search results is changed accordingly.

Back to filter

Click to display the **Select Search Parameters** dialog box.

Save results

Click to display a dialog box for saving a text file with Logbook entries as CSV file.

**Notice!**

When you open such an exported CSV file in Microsoft Excel, it can happen that time related cells do not display seconds.

To change this behavior, change the formatting of these cells from m/d/yyyy h:mm to m/d/yyyy h:mm:ss

12.16**Displaying text data**

Main window >  > Right-click an Image pane > **Text Data Show Bottom** or **Text Data Show Right**

or

Main window > Right-click an Image pane > **Text Data Show Bottom** or **Text Data Show Right**

**Notice!**

The system administrator must configure the recording of text data in Configuration Client.

You can display recorded text data in the text data pane.

The text values are displayed in the left column, the names of the text fields are displayed in the right column.

To find recordings with text data:

1. Select a time period.
2. Click .
3. Select **Please select a Server**.
4. Enter or select the required search criteria.
5. Click **Search**.

To display text data:

1. Move the hairline to a time position when an event with text data has been recorded.
2. In the Timeline, start the playback.

The text data is displayed in the text data pane.

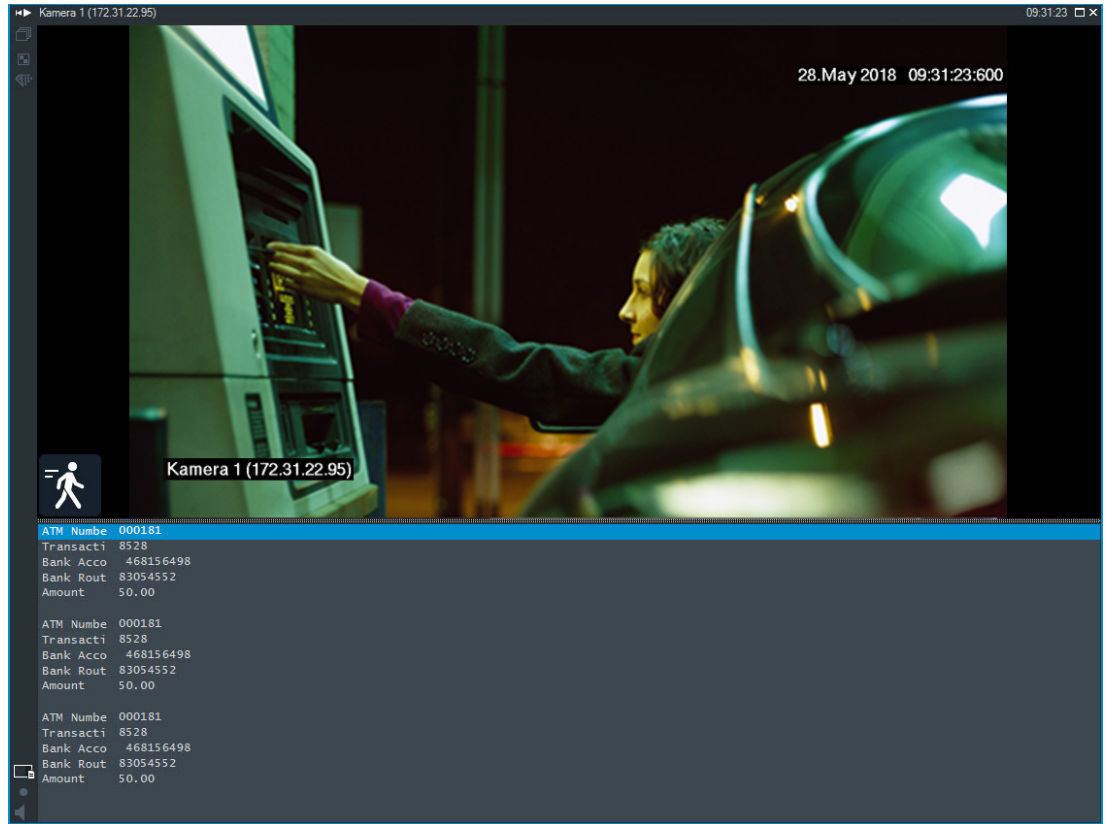

The following screenshot shows an example:



Refer to

– *Finding recorded video, page 74*

12.17 Searching for text data

Main window >  >  > Click  > **Please select a Server** entry > **Search for Text Data** dialog box

The operator can search for text data to find the corresponding recordings. The text data must be stored in the Logbook.

Text data is delivered by systems like foyer card readers, automatic teller machines, virtual inputs, LPR devices and Person Identification devices. Text data contains textual transaction data like account numbers, bank routing codes, person names or license plate countries. Text data of a device is recorded together with the corresponding video data.

Limitations

For searching recordings with text data, the text data must be configured to be stored in the Logbook.

The encoder for which you configure the recording text data function, must have firmware version 5.92 or later.

The text data of maximum 32 different devices can be recorded synchronously for one camera.

Maximum 3000 bytes of text data can be stored on an encoder per event.

If you see problems with Logbook searches, display of additional data, or CSV exports of Logbook search results, the reason can be that the additional text data contains non-printable characters, for example x00-x1F.

Search for Text Data dialog box

You can find text data in recordings. You can refine your search by adding specific text data with a specific value.

Entries in the **Data Field Name** field and the **Comparative Value** field are retained after the next restart or re-logout of Operator Client.

Sources

In the list, click to select the desired cameras for searching.

Date and Time

Displays the period in which you want to search.

Search Conditions

Add a search condition to refine your search.

12.18 Searching for text data in logbook entries

Main window > **Tools** menu > **Find in logbook...** command > **Please select a Server** dialog box (if required) > **Select Search Parameters** dialog box

Person Identification use case

It is possible to search for a specific person in all Person Identification events and alarms in order to find past recordings of the specific identified person.

You can search for the following text data in logbook entries in order to find a specific person:

- Person name
- Person group
- Person ID

To search for text data in logbook entries:

1. In the **Text Data** field click **Add/Edit** to limit the search to specific text data.
2. Click **Add Condition**.
3. Select the appropriate **Data Field Name**.
4. Type the **Comparative Value**.
5. Click **OK**.
6. Click **Search**.

The **Logbook results:** dialog box with the matching entries is displayed.

Refer to

- *Finding logbook entries, page 90*
- *Erasing text data from logbook entries, page 96*

12.19 Erasing text data from logbook entries

Tools > Erase text data from logbook...

In order to erase personal-related data if requested, you can erase text data from logbook entries.

Note: It is only possible to erase all personal-related text data from a logbook entry at once.

To erase text data from logbook entries:

1. Click **Erase text data from logbook...**

The **Select search parameters for erasing text data** dialog box is displayed.

2. Click **Add/Edit** to specify search criteria for text data.
3. In the **Data Field Name** column, select the appropriate entry.
4. In the **Comparative Value** column, type a search string. You can use * as a wildcard.
5. Click **OK**.
6. In the **Date and Time** field, enter start date and time and end date and time for the search process.
7. In the **Result Count** list, limit the number of matching entries that result from the search.
8. Click **Search**.
The **Logbook entries for erasing text data** dialog box with the matching entries is displayed.
9. Select the appropriate logbook entries.
You can select multiple entries by pressing the CTRL- or the SHIFT-key.
10. Click **Erase text data from selected entries**.
11. Click **OK**.
The text data of the selected entries is erased.

Select search parameters for erasing text data dialog box

Add/Edit

Click to display the **Search Conditions** dialog box.

Remove

Click to remove the selected condition entry.

Remove All

Click to remove all condition entries.

Search

Click to start the search. The **Logbook entries for erasing text data** dialog box is displayed.

Refer to

- *Finding logbook entries, page 90*
- *Searching for text data in logbook entries, page 96*

12.20

Displaying video via low bandwidth

Main window

You can play back the recordings of a camera or view live images of a camera with Operator Client even if you have a low bandwidth network connection between BVMS and your Operator Client computer.

Transcoders do not support intelligent tracking, ROI, Intelligent Video Analytics overlays, and text data.

For using low bandwidth networks, 2 options are available:

- Hardware transcoding
- Software transcoding (only available for Live Mode)

Hardware transcoding

For hardware transcoding the VRM must be equipped with at least one transcoding device. This transcoding device is not configured in BVMS. See the VRM documentation on how to configure a transcoding device. Transcoding devices can have multiple transcoding instances.

DIVAR IP 3000 and DIVAR IP 7000 are delivered each with one preconfigured transcoding instance.

Each live stream or recording needs an own transcoding instance.

Hardware transcoding is possible only for Video IP devices from Bosch connected to a VRM. Both camera and transcoding device must be managed by the same VRM.

Software transcoding



For software transcoding you need a Mobile Video Service configured on your Management Server or your Enterprise Management Server.

In an Enterprise System only the MVS services are used that are configured in the Enterprise Management Server configuration.

To select the preferred transcoding device, use the **Options** dialog box.

To enable transcoding:

1. In the Logical Tree, right-click the desired camera, point to **Preferred stream**, and then click to enable **Transcoding**.
2. Display the camera in an Image pane.
 - ⇒ This camera shows transcoded video.

In the toolbar of this Image pane, the  icon for hardware transcoding or the  icon for software transcoding is displayed.

If the affected camera is already displayed in an Image pane, it continues displaying untranscoded video until you close this Image pane.

If a transcoding request cannot be fulfilled, the related Image pane turns black.

To disable transcoding in Live Mode:

1. In the Logical Tree, right-click the desired camera, point to **Preferred stream**, and then select another stream.
2. Display the camera in an Image pane.
 - ⇒ This camera shows untranscoded video.
 - The transcoding icon is not displayed.

If the affected camera is already displayed in an Image pane, it continues displaying transcoded video until you close this Image pane.

To disable transcoding in Playback Mode:

1. In the Logical Tree, right-click the desired camera, point to **Preferred stream**, and then click to disable **Transcoding**.
2. Display the camera in an Image pane.
 - ⇒ This camera shows untranscoded video.
 - The transcoding icon is not displayed.

If the affected camera is already displayed in an Image pane, it continues displaying transcoded video until you close this Image pane.

Notice!



You can also enable or disable transcoding in an Image pane directly:

Right-click the item, point to **Select stream**, and then click the desired menu command.

This setting only affects the selected Image pane.

This command does not affect the setting for the preferred stream in the Logical Tree.

Refer to

- *Options dialog box, page 139*
- *Image pane, page 144*

12.21 Switching the recording source

Main window > 

If configured, you can change the recording source.

An icon for changing the recording source displays the current status.

Example:  indicates that Secondary VRM recording is displayed.

To switch:

- ▶ Click an icon for changing the recording source, for example .

The icon changes for example to .

The Timeline displays the recording of the selected source.

Refer to





- *Icons used, page 132*
- *Playing recorded videos, page 75*
- *Starting instant playback, page 47*

12.22 Unsynchronizing image panes

Main window > 

You can unsynchronize the playback of a specific image pane and control it independently by its embedded playback controls. This allows you, for example, to track a person across different cameras more effectively.

To unsynchronize the playback of an image pane:

1. Click . The icon changes to . The timeline displays a marker where the image is unsynchronized. A playback control bar appears in the image pane.
2. Use the playback control buttons to change the timeline position.
3. Click  to change back to synchronized playback.
4. Click  to synchronize all unsynchronized image panes.

12.23 Connecting to an unmanaged site

Main window

You can connect to an unmanaged site. All available devices of all video network devices of this site are then displayed in the Logical Tree. As soon as you log off or exit Operator Client, this connection is terminated.

To connect:

1. Right-click .
2. Click **Connect to Site**.

As long as the device is connecting,  is displayed.

After the connection is successfully established,  is displayed.
All available devices of this site are displayed in the Logical Tree.

If not all devices belonging to this site can be connected,  is displayed. You can later try to connect the remaining devices that were not connected now.

Tip: You can also double-click  to connect.

To connect remaining devices:

1. Right-click .
2. Click **Retry Connection**.

To disconnect a single site:

1. Right-click  or .
2. Click **Disconnect from Site**.

The icon changes: 

All Image panes with devices belonging to this site are automatically closed.

To disconnect all sites:

- ▶ Click  .
All sites are disconnected. Partially connected sites are not disconnected.
All Image panes with devices belonging to this site are automatically closed.

Refer to

- *Unmanaged site, page 19*

13 Handling events and alarms

This chapter provides information on how to handle alarms.
Some of the features described in this chapter can be deactivated for your user group.



Notice!

A site map displayed in an alarm image pane is optimized for display and contains only the initial view of the original map file.

Refer to

- *Managing Person Identification alarms, page 107*
- *Controlling access control functions, page 111*



13.1 Accepting an alarm

Main window >  >  tab
or

Main window >  >  tab

You can accept a single alarm or multiple alarms for clearing or starting a workflow.

To accept an alarm:

1. Select the desired alarm entry and click  .
2. For returning to the image window, click  .

When an alarm is accepted, several things happen simultaneously:

- The alarm is removed from alarm lists of all other users.
- If not already displayed, an alarm image window replaces the Live Image window on the monitor that has been enabled for alarms.
- The alarm content (live video, instant playback video, or site maps) is shown in a row of alarm image panes in the alarm image window.

- If there is a workflow associated with the alarm, the workflow button  is enabled.

You can now clear the alarm or start a workflow. If the alarm has been configured to "force workflow", then you must complete the workflow before you can clear the alarm.

To display an alarm camera on a monitor:

- ▶ Drag the camera image from its alarm image pane to a monitor group.

To accept all alarms on a map:

1. Display a map containing a camera hot spot in an Image pane.
2. Right-click a camera located on a map, and click **Accept all alarms of this device**. All alarms of this device are accepted. The alarm list displays the accepted alarms accordingly.

Refer to

- *Alarm List window, page 105*

13.2 Adding comments to an alarm

Main window >  >  tab > Select the desired alarm > ✓
or

Main window >  >  tab > Select the desired alarm > ✓
You can only comment an alarm after you have accepted it.

To add a comment to an alarm:

1. Click  .
The Workflow dialog box is displayed for entering a comment and displaying the action plan for this alarm. If no action plan is assigned to the alarm, the dialog box only displays the **Comment:** field.
2. In the **Comment:** field, type your comment.
3. Click **Close**.
4. Clear the alarm.
The comment is added as a separate entry in the Logbook and added to the alarm entry in the Logbook.

Refer to

- *Alarm List window, page 105*

13.3 Clearing an alarm

Main window >  >  tab
or

Main window >  >  tab

To clear an alarm:

- ▶ Select the desired alarm entries and click  .
If the alarm has the Comment or Force Workflow attribute, you cannot clear the alarm directly. In these cases you must first display the action plan and enter a comment. The alarm is cleared and removed from your Alarm List.
If no other alarms are currently being displayed, the Alarm Image window is closed and the Image pane is displayed.



To clear all alarms on a map:

1. Display a map containing a camera hot spot in an Image pane.
2. Right-click a camera located on a map, and click **Clear all alarms of this device**.
All alarms of this device are cleared. The Alarm List displays the cleared alarms accordingly.

Refer to

- *Alarm List window, page 105*

13.4 Customizing the Alarm List window

Main window >  >  tab
or

Main window >  >  tab

To sort the table:

1. Click a column heading.
The arrow in the column heading indicates whether the table is sorted in ascending or descending order.
2. To change the sorting order, click the column heading again.

To add or remove columns:

- ▶ Right-click the column heading and click a marked entry to remove the corresponding column or click an unmarked entry to add the corresponding column.

To change the sequence of columns:

- ▶ Drag a column title and move it to the required position.

To change the column width:

1. Point to the right border of the column heading. The pointer becomes a double-headed arrow . Drag the column border to the left or the right.
or
2. To quickly make the column wide enough to show all of its contents, double-click the right border of the column heading.

Refer to

- *Alarm List window, page 105*

13.5 Displaying the Live Image window

Main window >  > Alarm Image window
or

Main window >  > Alarm Image window

You can switch to the Live or Playback Image window when the Alarm Image window is displayed.

To display the Image window:

- ▶ In an Alarm Image window, click . The Image window is displayed.

To start/stop loop playback:

- ▶ Click .

Refer to

- *Alarm List window, page 105*
- *Image window, page 143*

13.6 Switching alarm displays of alarm image window

In the alarm image window you can switch the alarm display. The following displays are available:

- Multi-row alarm display
- Single view alarm display

To switch to multi-row alarm display:

▶ Click  .

To switch to single view alarm display:

▶ Click  .

To switch between the two alarm displays:

- ▶ Double-click somewhere in the alarm image window
or
double-click on a specific alarm image pane.



Notice!



If you are in multi-row alarm display and double-click somewhere in the alarm image window, the first image pane in the alarm image pane row will switch to the main image pane in single view alarm display. If you double-click on a specific alarm image pane in the alarm image window, this specific alarm image pane will switch to the main image pane in single view alarm display.

Refer to

- Alarm display, page 128

13.7

Starting a workflow

Main window >  >  tab
or

Main window >  >  tab

To start a workflow:



1. Select the required alarm entry and click  .
If this alarm has been configured to force a workflow, the action plan is displayed (if configured for this alarm). Additionally you can enter a comment if this is configured.
2. Perform the required actions.
3. Clear the alarm.

Refer to

- Alarm List window, page 105

13.8

Un-accepting an alarm

Main window >  >  tab
or

Main window >  >  tab

When you recall the acceptance of an alarm, it returns to Active state in your Alarm List, and it reappears in the Alarm Lists of all users that originally received the alarm.

To "un-accept" an alarm:

- ▶ Select the accepted alarm entry and click  .
The alarm is displayed as active again.

Refer to

– Alarm List window, page 105

13.9 Triggering a user event

Main window >  > Click 

You can trigger a user event for a selected Management Server of an Enterprise System that has been configured in Configuration Client.

- ▶ Right-click the desired  and click the desired user event command.
- ⇒ The event is triggered.

13.10 Alarm List window



Click to accept an alarm.
The alarm is removed from all Alarm Lists and alarm video displays of the other operators.



Click to display a dialog box displaying an action plan. If configured, you can enter a comment.



Click to clear an alarm.
You cannot clear an alarm that has the comment or force workflow attribute before you have displayed the action plan and entered a comment. If the alarm is configured as an auto-clear alarm, the alarm is removed from the Alarm List after the auto-clear time (configured in the Configuration Client).



Click to revoke the acceptance of an alarm.



Click to turn alarm audio on / off.
The latest incoming alarm triggers an alarm sound.



Click to display the Alarm List.

Refer to

- *Alarm handling, page 23*

14 Managing Person Identification alarms

When you accept a Person Identification alarm, information about the identified person is displayed in the image pane.

Person Identification information

Person group	Person group is the group that a person is assigned to.
Person image(s)	The default image and all available images from the Person Identification device are displayed.
Person name	The person name is the name of the identified person.
Confidence factor	The confidence factor is a measure of the degree of correctness a person is identified by the system in percentage (0 is no correctness, 100 is full correctness).

Refer to

– *Handling events and alarms, page 101*

14.1 Managing persons for a Person Identification alarm

Tools > Manage persons... > Manage persons dialog box

The **Manage persons** dialog box allows you to add persons, assign person groups, add images to existing persons and export persons.



Notice!

Person Identification only supports JPEG files.

To add/import a person:

1. Select a person.
2. Click  to add an image of a person.
Or
drag an image of a person from your file explorer to a person group or the **All** tab.
⇒ This image is assigned as the default image of the person.

To add images to an existing person:

1. Select a person.
The default image and all available images of the person are displayed.
2. Click  in the images window to add more images to the person.

To assign a new default image:

1. Move the mouse over the appropriate image.
The **Set as default** command is displayed.
2. Click the **Set as default** command.
The image is assigned as default image.

To assign a person group to a person:

1. Select a person.
For every new person the **Default person group** value is already selected.
2. Click in the **Default person group** field.
3. Select the appropriate person group you want to assign to the person.

To export persons:

1. Select a person.
2. Click  to export the person to the file explorer.

**Notice!**

 is disabled, if the **All** tab is selected. Select the **Default person group** tab or any other available person group tab to export persons.

To delete a person:

1. Select a person.
2. Click .

To delete multiple persons:

1. Select a person
2. Press the CTRL-key and select multiple persons.
3. Click .

To delete single person images:

1. Select the appropriate image.
2. Click .

Note: If you delete the default image, the next image is automatically assigned as the default image.

To search for person names:

1. In the search field, type the name of the person that you search.
Note: As soon as you start typing, the results will already be filtered and displayed. You can immediately start searching for names even if the Operator Client is still importing the person list and the corresponding person images.
2. To discard your search, click  or press the esc key.

15 Controlling intrusion panel functions

You can control several intrusion panel functions from within the Operator Client.

15.1 Switching off alarm sirens

Main window

You can switch off alarm sirens of an intrusion panel area if you have the corresponding permission.

To switch off an alarm siren:

- ▶ In the Logical Tree or in a map, right-click the desired area  and click **Silence Bells**.

The alarm siren is silent.

15.2 Operating doors

Main window

You can control the following intrusion panel states of a door from within Operator Client:

- Secure a door.
- Unsecure a door. The state changes to locked.
- Lock a door.
- Unlock a door. You can lock or secure an unlocked door.
- Cycle a door.

The system administrator can limit the permission for each of these functions to specific user groups.

To lock a door means that an authorized cardholder can open the door using the card.

To unlock a door, means that the door is open for anybody.

To secure a door means that nobody can open the door, not even the authorized cardholders.

To cycle a door means to unlock a locked door for a few seconds, then lock it again.

To operate:

- ▶ Right-click a door in the Logical Tree or in a map and click the required command.

The following commands are available:

- **Lock / Unlock**
- **Secure / Unsecure**
- **Cycle**

Note: The context menus for operating a door are not available when the state of this door is unknown.

Refer to

- *Icons used, page 132*

15.3 Bypassing a point

Main window

You can change the state of a point to the **Bypassed** state within Operator Client.

The system administrator can limit the permission for this function to specific user groups.

When you unbyypass a point, you change its state back to normal.

To bypass a point means that this point cannot send any alarm. To unbyypass a point means that this point can send alarms. Pending alarms are also sent if available.

To bypass or unby-pass:

- ▶ Right-click a point in the Logical Tree or in a map and click the required command.

Note: The context menus for bypassing and unby-passing are not available when the state of the device is unknown.

Refer to

- *Icons used, page 132*

15.3.1**Arming an area**



Main window

You can control the following intrusion panel states of an area from within Operator Client:



- Arm an area.
- Disarm an area.
- Force the arming of an area that is not ready for arming.

The system administrator can limit the permission for each of these functions to specific user groups.



To arm an area:

- ▶ In the Logical Tree, right-click the desired disarmed area () and click **Arm**. The icon for an armed area () is displayed.

To disarm an area:

- ▶ In the Logical Tree or in a map, right-click the desired armed area () and click **Disarm**. The icon for a disarmed area () is displayed.

To force the arming of an area:

- ▶ In the Logical Tree or in a map, right-click the desired disarmed area () and click **Force Arm**. The icon for an armed area () is displayed.

Note: The context menus for arming and disarming are not available when the state of the device is unknown.

16 Controlling access control functions

You can control several access control functions from within the Operator Client.

Refer to

- *Handling events and alarms, page 101*

16.1 Granting and denying access

Main window



Notice!

Only **Access requested** alarms with high priority will automatically pop-up in the image window.

To grant or deny access:

Click  to accept the **Access requested** alarm.
An alarm-timer is now running, that shows how much time is left.

► Click  to grant access.
Or

click  to deny access.



Notice!

Once the timer has run out, the system will automatically deny access for this specific request.

16.2 Operating doors

Main window

You can control the following access control door states from within the Operator Client:

- Secure a door.
- Lock a door.
- Unlock a door.

The system administrator can limit the permission of these functions to specific user groups.

To secure a door means that an authorized person can open the door using, for example, a card.

To lock a door means that nobody can open the door, even not authorized persons.

To unlock a door means that the door is open for anybody. You can lock or secure an unlocked door.

To operate:

- Right-click a door in the Logical Tree or in a map and click the required command.

The following commands are available:

- **Lock door / Unlock door**
- **Secure door**

Note: The context menus for operating a door are not available when the state of this door is unknown.

17 Using a CCTV keyboard

This chapter describes how to use BVMS Operator Client with a Bosch IntuiKey keyboard or a KBD Universal XF keyboard.

17.1 Using KBD Universal XF keyboard



Notice!

Refer to the Instructions Manual delivered with your KBD-Universal XF keyboard available on the online product catalog.

You can use the KBD-Universal XF keyboard as a USB keyboard for BVMS.













Attach the keyboard template for BVMS to the keyboard before use.

You can configure the keyboard for use by a left-handed operator. Refer to the Instructions Manual delivered with the KBD Universal XF keyboard.

17.1.1 KBD Universal XF keyboard user interface

The following table lists the icons on the keyboard template and their respective function.

Icon	Function
	Trigger a user event, only available with single Management Server
	Audio on / off Blinking indicates that the function is enabled.
	Start /stop alarm recording
	Toggle between Live Mode and Playback Mode Blinking indicates that the function is enabled.
	Toggle selected Image pane between Live Mode and instant playback. Blinking indicates that the function is enabled.
	Load a sequence. Enter a valid sequence number and confirm with OK . Use the playback buttons for controlling the sequence. Blinking indicates that the input of a number is required.
	Reduce number of Image panes
	Increase number of Image panes
	Full-screen on / off
	Maximize / restore selected Image pane

Icon	Function
ESC	Breaks the entering of a number. Press twice to close selected Image pane.
OK	Confirm a number entry.
	PTZ mode on/off. Blinking indicates that the function is enabled.
	Select a PTZ position. Enter a valid number of a preset and confirm with OK . Blinking indicates that the input of a number is required.
	Focus far
	Focus near
	Iris closed
	Iris open
	Analog monitor mode on /off. Enter a valid monitor number, press OK , enter a valid camera number and press OK . Blinking indicates that the input of a number is required.
	Set the default Management Server, only available when you log on to Operator Client as a user of an Enterprise User Group. Enter a valid server number and confirm with OK . Blinking indicates that the input of a number is required.
	Fast backward (stepwise)
	Play backward
	Pause
	Play
	Fast forward (stepwise)

When a button is not illuminated, it does not have any function. All illuminated buttons have a function.

When a button is blinking, its function is active, for example Playback button is blinking means that the Playback Mode is active. Press the button to toggle to the other state, for example pressing the blinking Playback button switches to Live Mode.

Enter a number and confirm with OK to display the respective camera in the selected Image pane.

17.2 Bosch IntuiKey keyboard user interface



Notice!

Every input on the keyboard is cleared after some seconds if no further input is made.

This chapter describes the user interface of the Bosch IntuiKey keyboard. The following illustration shows the various interface elements of the keyboard:

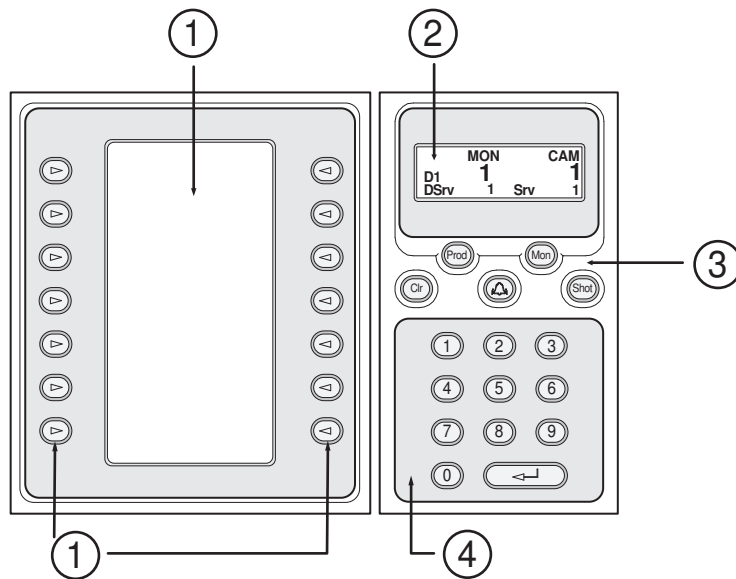

1	Softkeys and softkey display	Allow you to use a fixed set of commands or to control the Logical Tree. The commands displayed in the softkey display change depending on the operation mode.
2	Status display	Changes dynamically and displays information on the current operation mode.
3	Function keys	<p>Allow you to control certain functions directly.</p> <p>Prod: Starts a scan process to find the connected workstation. If scanning is successful: In the softkey display, Terminal and Keyboard Control menus are displayed. For selecting BVMS, press the Terminal softkey.</p> <p>Mon: Allows you to enter a monitor number (digital or analog monitor).</p> <p>Clr: Clears any numeric entry or has a Back-function.</p> <p>: Currently not supported.</p> <p>Shot: Allows you to select a camera pre-position or to leave Selection mode.</p>

4	Numeric keypad with ENTER key	Allows you to enter logical numbers. The number is displayed in the status display. Unless preceded by pressing the Mon or Shot key, a numeric entry is interpreted as a logical camera number. The camera with the entered number is displayed in an Image pane or an analog monitor.
---	-------------------------------	--

17.2.1

Status display

The status display changes dynamically to display information about the keyboard’s present mode of operation.

The following illustration shows the various elements of the status display:

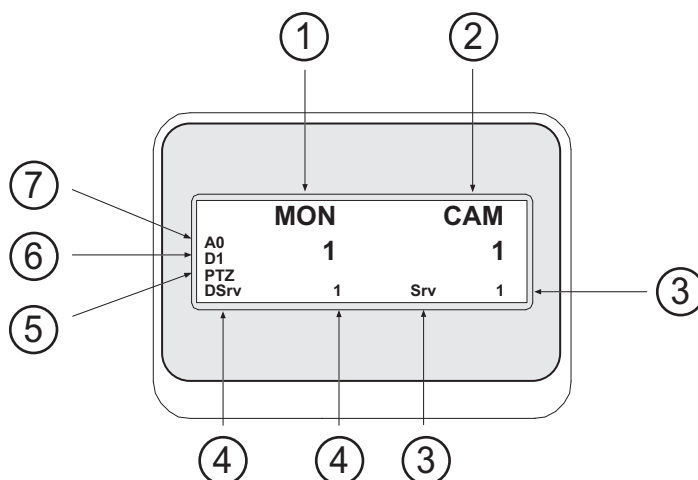

1	Monitor	Displays the selected analog monitor or Image pane number.
2	Camera	Displays the selected camera number.
3	Server	Displays the server number of the Management Server where the currently selected camera is configured.
4	Default Server	Displays the server number of the Management Server of an Enterprise System that the keyboard uses as default server. The Logical Tree of this server is displayed in the Tree Mode.
5	PTZ / JOGSHUTTLE	Displays the current operation mode.
6	D1	Displays the selected computer monitor number.
7	A0	Displays the selected analog monitor number.

17.3

Using a Bosch IntuiKey keyboard connected to a workstation

A keyboard connected to a BVMS workstation offers a wide variety of features. Both the analog and the digital mode are available.

If the keyboard is connected to a decoder, the feature set is reduced. Only the analog mode is available.

When connected to a workstation that is using an Enterprise System, you must first select the desired Management Server and then the camera configured on this Management Server.

Refer to

- *Bosch IntuiKey keyboard user interface, page 115*

17.3.1 Starting the IntuiKey keyboard

The keyboard must be connected to a COM port of a workstation.

1. Start the Operator Client on the workstation.
2. Press the Prod button.
The keyboard scans for connected devices.
3. Press the Terminal softkey.
The Selection Mode is displayed.

17.3.2 Entering operation modes

You can use the keyboard in the following modes:

- Selection Mode
This mode allows you to select an Image pane by moving the joystick in the desired direction.
- PTZ Mode
This mode allows you to control fixed and PTZ cameras, maps, and documents in Live Mode.
- Jogshuttle Mode
This mode allows you to control cameras in instant playback or in Playback Mode.

To enter Selection Mode:

1. Start the Operator Client and the keyboard.
or
2. Press ENTER to leave PTZ or Jogshuttle Mode and to return to Selection Mode.

To enter PTZ Mode:

1. Select a PTZ camera.
2. Press Shot.
To start a preposition, press Shot again, press the number of a preposition, and press ENTER.

To enter Jogshuttle Mode:

1. Start Playback Mode.
2. Press Shot.

To leave PTZ or Jogshuttle Mode:

- ▶ Press ENTER to leave PTZ or Jogshuttle Mode and start Selection Mode again.

17.3.3 Displaying cameras

Enter a numeric command to display the camera with this logical number in the active Image pane or analog monitor.

To display cameras of an Enterprise System, select the Management Server where these cameras are configured.

Toggling between analog mode and workstation mode

- ▶ Press Mon twice.

Displaying a camera in a computer monitor

1. Switch to a digital mode.

2. Press Mon, press 1 - 4 to select the desired workstation monitor, press the number of the desired Image pane and press ENTER.
The numbering of Image panes is from left to right and top to bottom.
3. Press the desired number of the camera and press ENTER.
The desired camera is displayed.
Example: Press Mon, 412, and ENTER. Then press 7 and ENTER. Camera 7 is displayed on the 12th Image pane on workstation monitor 4.

Selecting a Management Server of an Enterprise System:

1. Press NEXT.
2. Press the  softkey and enter the server number.
The server number is configured in Configuration Client in the **Server Number** list.
When you now enter the logical number of a camera, a camera configured on this Management Server is displayed.

Displaying a camera in an analog monitor

1. Switch to analog mode.
2. Press Mon, press the number of the desired monitor, and press ENTER.
Monitor numbers are configured in the Configuration Client.
3. Press the desired number of the camera and press ENTER.
The desired camera is displayed.
Example: Press Mon, 3, and ENTER. Then press 4 and ENTER. Camera 4 is displayed in the 3rd analog monitor.



Notice!

When you call up a PTZ camera by a numeric command, the system automatically enters PTZ mode.

17.3.4

Using the joystick of IntuiKey keyboard

In Selection Mode, the joystick allows you to use the following features:

- Tilt the joystick to select an Image pane.

In PTZ Mode, the joystick allows you to use the following features:

- Twist the joystick to zoom in and out.
- Tilt the joystick to pan and tilt a PTZ camera.
- Use Focus and Iris buttons for a PTZ camera.

In Jogshuttle Mode, twist the joystick to use the following features:

- Play forward/backward as long as you twist.
- Change the playback speed: Speed depends on the degree of rotation.
- Stop a video when playing.

In Jogshuttle Mode, tilt the joystick to use the following features:

- Tilt up / down when video is stopped: Play forward / backward.
- Tilt up / down when video is playing: Set the playback speed.
- Tilt right / left: Pause and step forward / backward.

In Jogshuttle Mode, the Focus and Iris buttons allow you to use the following feature:

- Press Focus or Iris to move the hairline in the Timeline forward or backward. Focus moves the hairline for a larger amount of time forward or backward, Iris moves the hairline for a smaller amount of time forward or backward.

Playback Mode :

- To lock the system in the current playback speed, press the Shot button while twisting the joystick.

17.3.5 Using softkeys of IntuiKey keyboard

The following operation modes are available:

- Tree Mode
You use this operation mode to control devices that are available in the Logical Tree of the Operator Client.
- Command Mode
You use this operation mode to send commands like switch to Playback Mode.

To toggle between Tree Mode and Command Mode:

1. In the Tree Mode: Press the left Level Up softkey as often as needed to display the root level and then press the Exit softkey to display the Command Mode.
or
2. In the Command Mode: Press the Tree Mode softkey.

To use the Logical Tree mode:

- ▶ Switch to the Tree Mode.

Right side of the softkey display:

- ▶ Press a softkey to control the item (e.g. display a camera or switch a relay).
When you press a map or a folder (black background), it moves to the left side. The right side displays the its content.

Left side of the softkey display:

1. Press a softkey on the left side to select a folder or a map and to display its content on the right side of the softkey display.
To display a map, press the softkey once to mark it (with a rectangle) and press the softkey again to display it in the selected Image pane.
2. Press Level Up to enter the next upper level of the Logical Tree.
3. Press UP to move the selection upward or DOWN to move downward.

The following figures show an example of a Logical Tree and its representation on the softkey display of the keyboard.

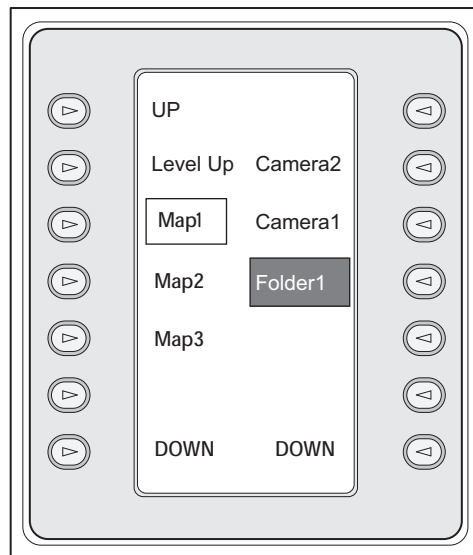
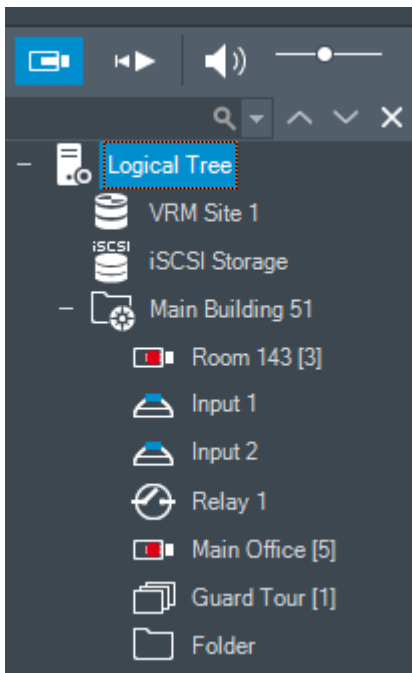

To use the Command Mode:

1. Switch to the Command Mode.
2. Press a softkey to execute the desired command.

The following commands are available:

- : Load a sequence. In the **Status Display**, enter the sequence number.
- : Sequence play, pause
- : Sequence step forward / backward
- : Maximize / restore selected Image pane
- : Close selected Image pane
- : Toggle between Live Mode and Playback Mode
- : Toggle selected Image pane between Live Mode and instant playback
- : Show more Image pane rows / Show fewer Image pane rows
- **Note:** You cannot display more Image pane rows than the configured maximum, which is set by a parameter in the BVMS Configuration Client.
- / **REC**: Start /stop alarm recording
- : Audio on / off
- **NEXT**: Switch to next page
- : Trigger a user event (1-4), only available with single Management Server
- : Set the default Management Server, only available when you log on to Operator Client as a user of an Enterprise User Group.
- : Image pane bars on / off
- : Full-screen on / off

You cannot display more Image pane rows than the configured maximum, which is set by a parameter.

17.4 Using a Bosch IntuiKey keyboard connected to a decoder

A keyboard connected to a decoder gives you access to the Management Server without Operator Client software. Hence, you must log on. Only the analog mode is available.

17.4.1 Starting the keyboard

After starting the keyboard you must log on to the Management Server.



Notice!

Only BVMS users with number-only user names and number-only passwords can use the analog mode of a Bosch IntuiKey keyboard.

The user must have access rights for the decoder connected to the Bosch IntuiKey keyboard.

To start the keyboard:

- ▶ Press the Terminal softkey.
The following logon display is shown:

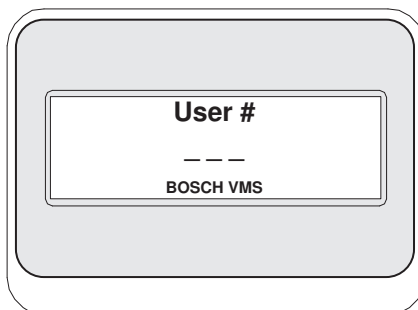

- ▶ Enter the user name.

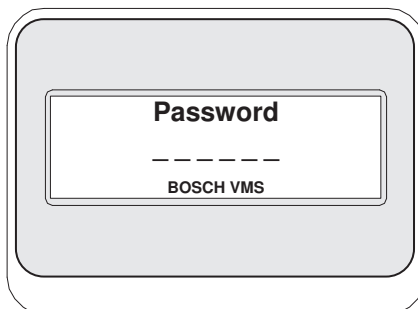

After successful logon, the Terminal and Keyboard Control softkeys are displayed in the softkey display.

17.4.2 Displaying cameras

1. Press Mon, press the number of the desired monitor, and press ENTER.
Monitor numbers are configured in the Configuration Client.
2. Press the desired number of the camera and press ENTER.
The desired camera is displayed.
Example: Press Mon, 3, and ENTER. Then press 4 and ENTER. Camera 4 is displayed in the 3rd analog monitor.
When the selected monitor displays a PTZ camera, the keyboard switches to PTZ mode automatically.

17.4.3 Using the joystick

The joystick allows you to use the following features:

- Twist the joystick to zoom in and out.
- Tilt the joystick to pan and tilt a PTZ camera.
- Use Focus and Iris buttons for a PTZ camera.

17.4.4 Using softkeys

The following operation mode is available:

- Command Mode

To use the Command Mode:

- ▶ Press a softkey to execute the desired command.

The following commands are available:

- Start /stop alarm recording
- Log off

18 User interface

This chapter contains information on all windows available in Operator Client of BVMS.



Notice!

This document describes some functions that are not available for BVMS Viewer.

For detailed information about the different BVMS editions refer to www.boschsecurity.com and the BVMS Quick Selection Guide: [BVMS Quick Selection Guide](#).

Refer to

- Live Mode, page 123
- Playback Mode, page 125
- Alarm display, page 128

18.1 Live Mode



Main window >

You automatically access Live Mode every time you log on.

Allows you to move, resize, or hide all control elements as required.

You can right-click to display the context menu.

If an incoming alarm has a lower priority than the currently displayed image window, the







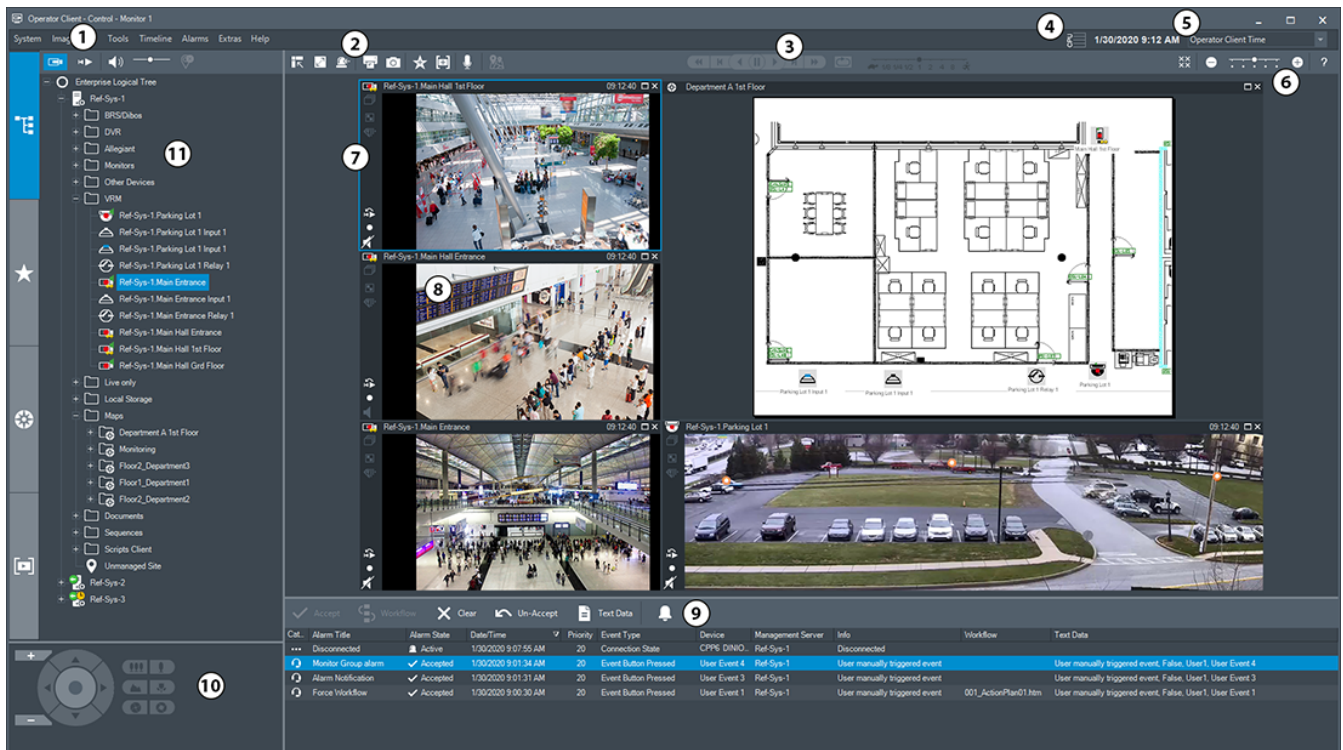

tab starts blinking and indicates an alarm.

If an incoming alarm has a higher priority than the currently displayed image window, the incoming alarm displays automatically (automatic pop-up alarm).



1	Menu bar	Allows you to select a menu command.
2	Toolbar	Displays the available buttons. Point to an icon to display a tooltip.

3	Playback controls	Allows you to control instant playback or a camera sequence or alarm sequence.
4	Performance meter	Displays the CPU usage.
5	Time zone selector	Select an entry for the time zone to be displayed in most time related fields. Only available if at least one Management Server or unmanaged site in the Logical Tree is located in another time zone as your Operator Client.
6	Controls for Image panes	Allows you to select the required number of Image panes and to close all Image panes.
7	Image window	Displays the Image panes. Allows you to arrange the Image panes.
8	Image pane	Displays a camera, a map, an image, a document (HTML file).
9	 Alarm List window	Displays all alarms that the system generates. Allows you to accept or clear an alarm or to start a workflow, for example, by sending an E-mail to a maintenance person. The Alarm List is not being displayed, when the connection to the Management Server is lost.
10	 PTZ Control window	Allows you to control a PTZ camera.
11	 Logical tree window	Displays the devices your user group has access to. Allows you to select a device for assigning it to an Image pane.
	 Favorites tree window	Allows you to organize the devices of the Logical Tree as required.
	 Bookmarks window	Allows to manage bookmarks.
	 Map window	Displays a site map. Allows you to drag the map to display a particular section of the map. If activated, a map is displayed automatically for each camera displayed in an Image pane. In this case, the camera must be configured on a map.

Refer to

- *Menu commands, page 137*
- *Logical Tree window, page 142*
- *Favorites Tree window, page 142*
- *PTZ Control window, page 146*
- *Image window, page 143*

- Image pane, page 144
- Alarm List window, page 105

18.2 Playback Mode



Main window >

You can right-click to display the context menu.







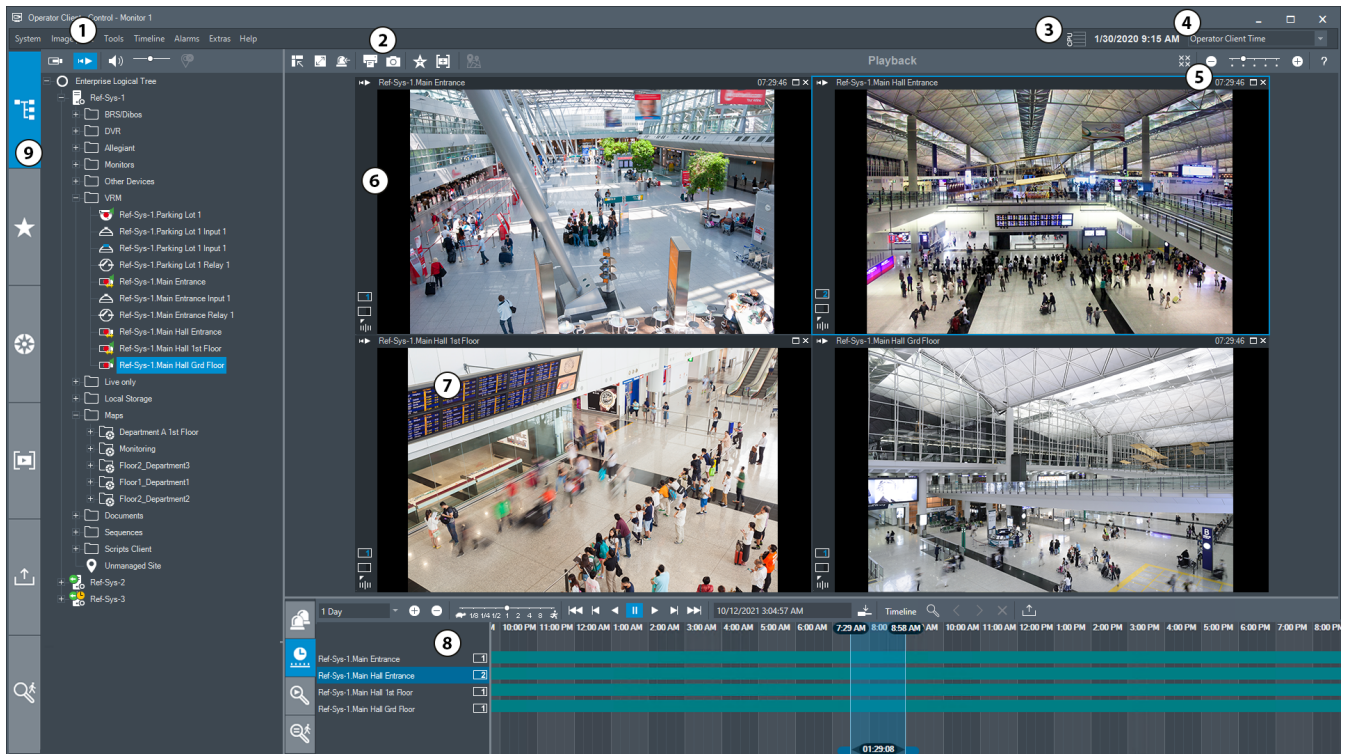



If an incoming alarm has a lower priority than the currently displayed image window, the



tab starts blinking and indicates an alarm. If the incoming alarm has a higher priority than the live or playback image window, the alarm image window is displayed automatically. The priorities are configured in the Configuration Client.



1	Menu bar	Allows you to select a menu command.
2	Toolbar	Displays the available buttons. Point to an icon to display a tooltip.
3	Performance meter	Displays the CPU usage and the memory usage.
4	Time zone selector	Select an entry for the time zone to be displayed in most time related fields. Only available if at least one Management Server or unmanaged site in the Logical Tree is located in another time zone as your Operator Client.
5	Controls for Image panes	Allows you to select the required number of Image panes and to close all Image panes.

6	Image window	Displays the Image panes. Allows you to arrange the Image panes.
7	Image pane	Displays a camera, a map, an image, a document (HTML file).
8	 Alarm List window	Displays all alarms that the system generates. Allows you to accept or clear an alarm or to start a workflow, for example, by sending an E-mail to a maintenance person. The Alarm List is not being displayed, when the connection to the Management Server is lost.
	 Video search results window	Displays recordings that match the video search criteria.
	 Forensic Search results window	Displays recordings that match the Forensic Search criteria.
	 Timeline window	Allows to you to navigate through the recorded videos.
9	 Device Tree window	Displays the devices your user group has access to. Allows you to select a device for assigning it to an Image pane.
	 Favorites tree window	Allows you to organize the devices of the Logical Tree as required.
	 Map window	Displays a site map. Allows you to drag the map to display a particular section of the map. If activated, a map is displayed automatically for each camera displayed in an Image pane. In this case, the camera must be configured on a map.
	 Bookmarks tree window	Allows to manage bookmarks.
	 Exports tree window	Allows you to load exported video data to display it or to search for particular data.
	 Forensic Search window	Allows you to configure Forensic Search. Forensic Search allows you to search for specific properties in the video of the selected image pane.

Refer to

- *Menu commands, page 137*
- *Logical Tree window, page 142*
- *Favorites Tree window, page 142*
- *Exports window, page 145*
- *Map window, page 146*
- *PTZ Control window, page 146*
- *Image window, page 143*
- *Image pane, page 144*
- *Timeline window, page 147*
- *Forensic Search Results window, page 90*
- *Video Search Results window, page 75*
- *Alarm List window, page 105*

18.3 Threat level mode

Main window > 

Or main window > 

When in threat level mode, depending on the user group, the user may have restricted permissions.

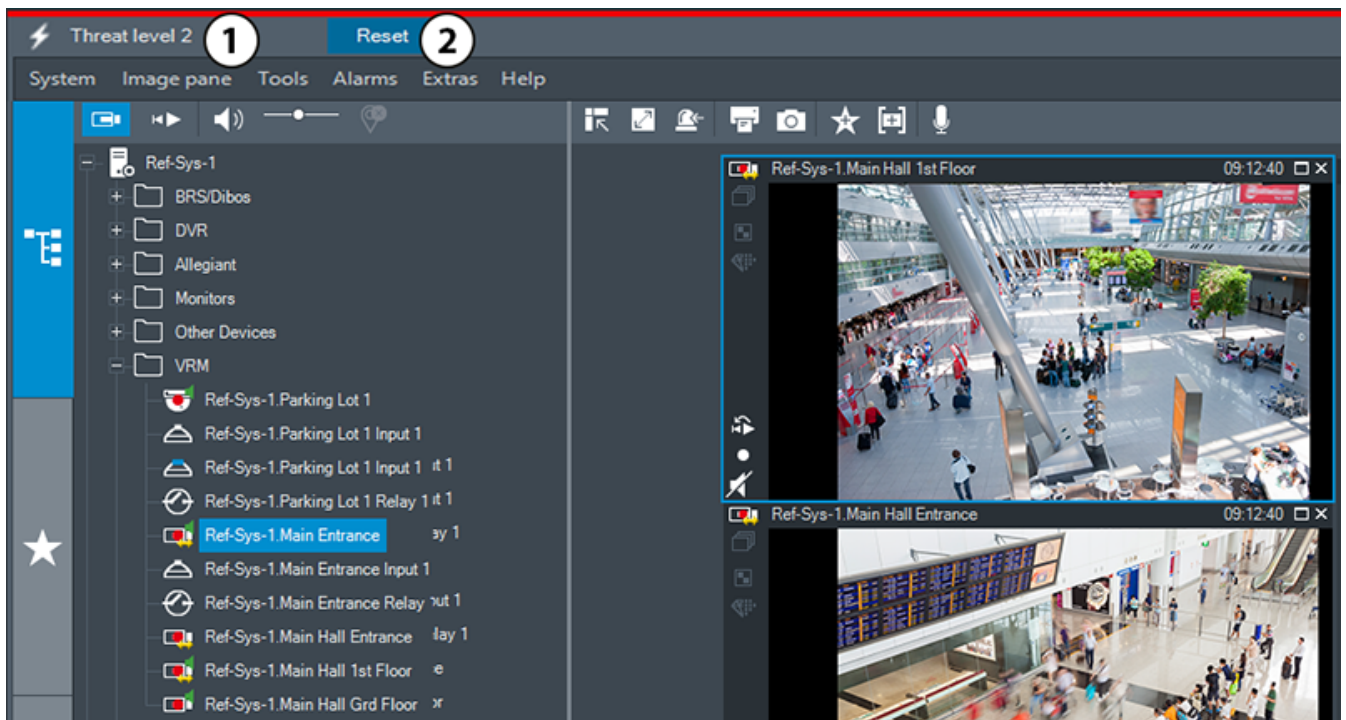



Figure 18.1:

1	Threat level	The threat level mode is indicated by a red line. The current threat level (for example Threat level 2) is displayed.
----------	---------------------	---

2	Reset	The Reset button only displays if the user has the respective permission. Click to end the threat level mode.
----------	--------------	--

18.4 Alarm display

Main window >  Select an alarm >  **Accept**

Or main window >  >  tab > Select an alarm >  **Accept**

The alarm image window displays live or instant playback video from a camera, maps, documents or map viewports to be displayed in case of an alarm. The alarm image window is displayed automatically if the incoming alarm has a higher priority than the live or playback image window. The priorities are configured in the Configuration Client.

If an incoming alarm has a lower priority than the currently displayed image window, the



tab starts blinking and indicates an alarm.







If multi-row alarm is configured and when more alarms are displayed than alarm image rows are available, the display in the last row is sequenced. You can control the alarm sequence with the playback controls in the alarm image window toolbar. You cannot perform instant playback in the last row.

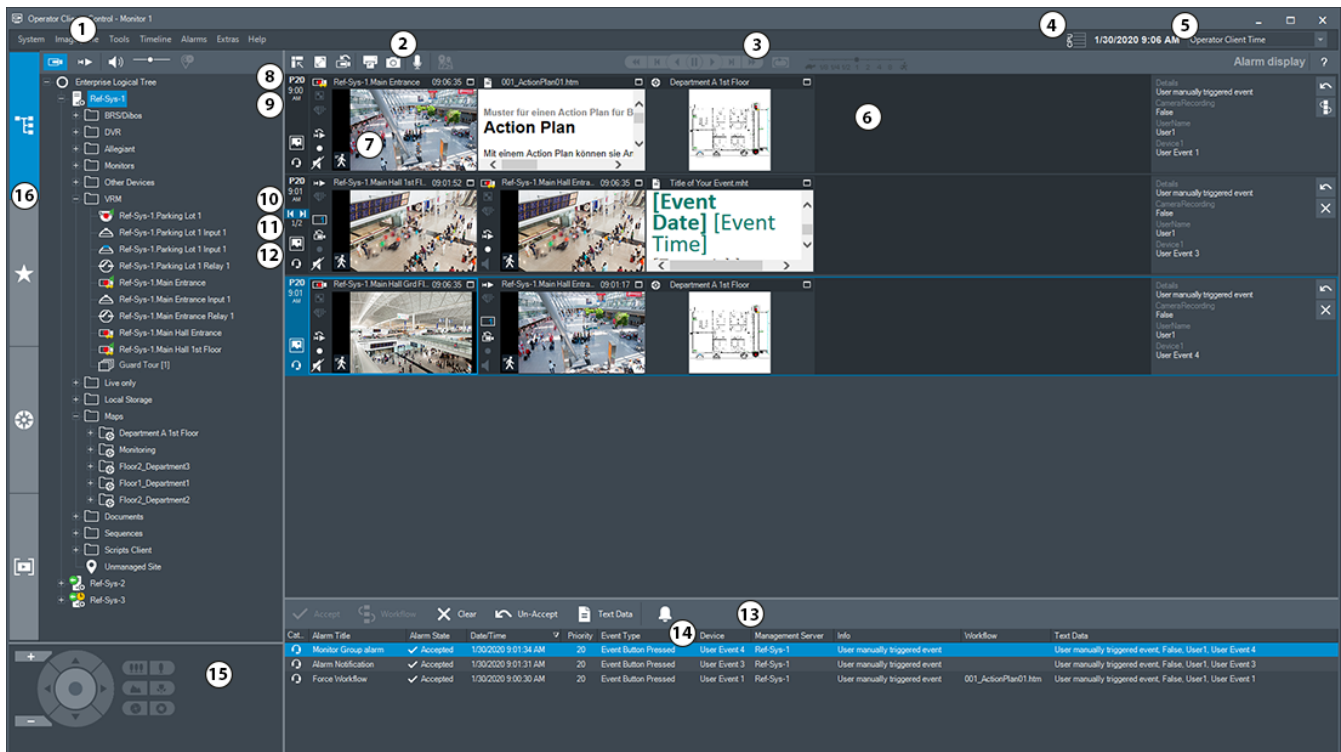



Notice!

A site map displayed in an alarm image pane is optimized for display and contains only the initial view of the original map file.



1	Menu bar	Allows you to select a menu command.
2	Toolbar	Displays the available buttons. Point to an icon to display a tooltip.
3	Playback controls	Allows you to control instant playback or a camera sequence or alarm sequence.
4	Performance meter	Displays the CPU usage and the memory usage.
5	Time zone selector	Select an entry for the time zone to be displayed in most time related fields. Only available if at least one Management Server unmanaged site in the Logical Tree is located in another time zone as your Operator Client.
6	Alarm Image window	Displays the Alarm Image panes.
7	Alarm Image pane	Displays a camera, a map, an image, a document.
8	Alarm priority	Displays the priority value that was configured in the Configuration Client for the automatic display behavior.
9	Time	Displays the time when the alarm was triggered.
10	Alarm Sequence buttons	Click to display the previous or next Alarm Image pane.
11	Number of alarms	Displays the number of the currently displayed alarm and the number of all alarms.
12		Click to switch to multi-row alarm display.
		Click to switch to single view alarm display.
13	 Alarm List window	Displays all alarms the system generates. Allows you to accept or clear an alarm or to start a workflow, for example, by sending an E-mail to a maintenance person. The alarm list is not being displayed, when the connection to the Management Server is lost.
14	Event Type	Indicates the type of event that triggered the alarm.
15	 PTZ Control window	Allows you to control a PTZ camera.
16	 Logical tree window	Displays the devices your user group has access to. Allows you to select a device for assigning it to an Image pane.
	 Favorites tree window	Allows you to organize the devices of the Logical Tree as required.

	 Bookmark window	Allows to manage bookmarks.
	 Map window	Displays a site map. Allows you to drag the map to display a particular section of the map. If activated, a map is displayed automatically for each camera displayed in an Image pane. In this case, the camera must be configured on a map.

Refer to

- *Switching alarm displays of alarm image window, page 103*
- *Menu commands, page 137*
- *Logical Tree window, page 142*
- *Favorites Tree window, page 142*
- *Map window, page 146*
- *PTZ Control window, page 146*
- *Image window, page 143*
- *Image pane, page 144*
- *Alarm List window, page 105*

18.5

Map-based tracking assistant display

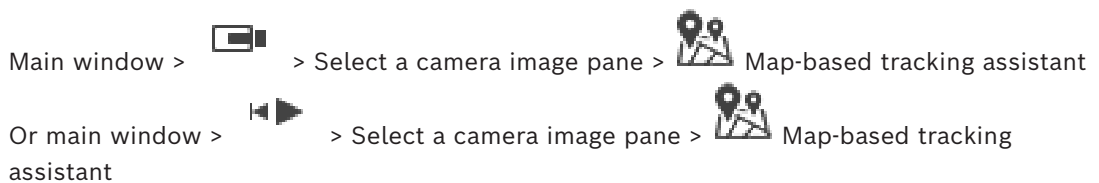

The Map-based tracking assistant helps you to track moving objects across multiple cameras. The respective cameras have to be configured on the global map. If an interesting moving object appears in live, playback, or in an alarm image pane, the user can start the Map-based tracking assistant that displays all nearby cameras automatically.

If a camera is in instant playback mode or in playback mode and you start the Map-based tracking assistant, only the cameras that support playback are available in the Map-based tracking assistant display.





If an incoming alarm has a lower priority than the currently displayed image window, the

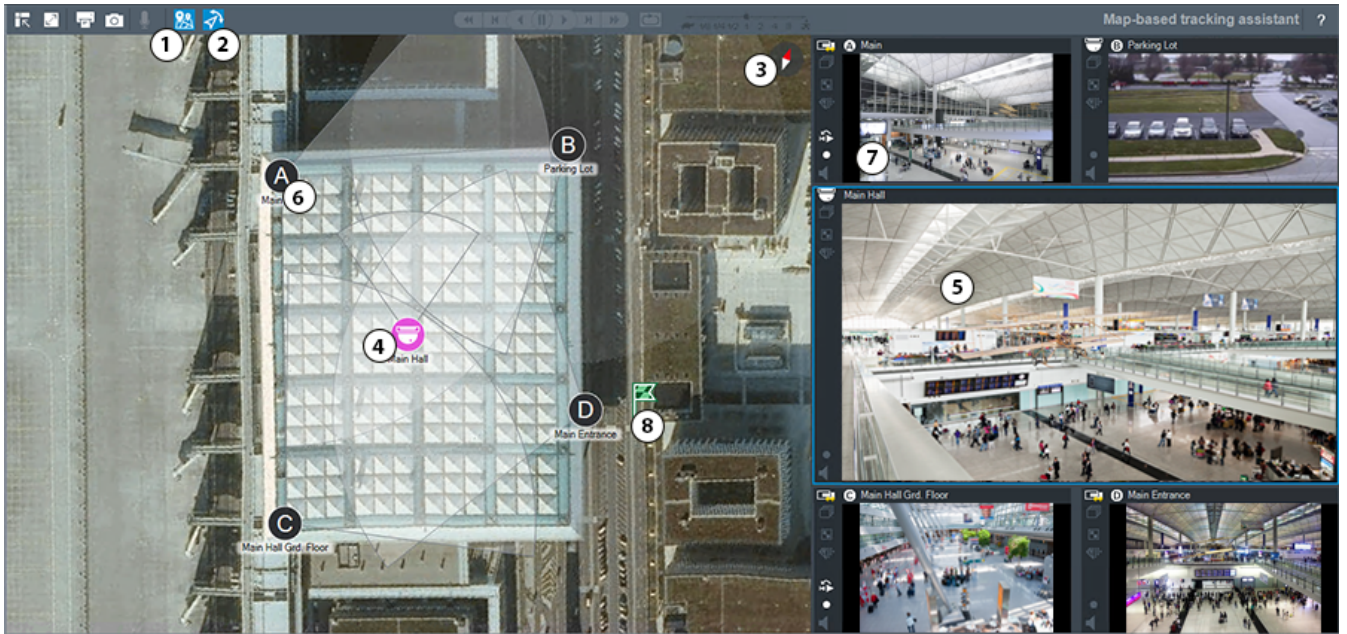

tab starts blinking and indicates an alarm.

If an incoming alarm has a higher priority than the currently displayed image window, the incoming alarm displays automatically (automatic pop-up alarm).



1	 Map-based tracking assistant	Click to start or stop the Map-based tracking assistant.
2	 First person view	Click to start or stop First person view. When you start the Map-based tracking assistant First person view is enabled by default.
3		Click to align the global map to default north orientation.
4	Main camera	The main camera displays in the central image pane of the Map-based tracking assistant.
5	Main image pane	The central image pane displays the main camera image.
6	Neighbor camera	The neighbor cameras are indicated by Latin letters A-D. When first starting the Map-based tracking assistant, those letters also display for some seconds in the respective image panes.
7	Side image pane	The side image panes display the neighbor cameras, whose field of view overlap with the main cameras field of view or are closest by distance.
8		When you click a location on the global map, the  symbol displays for some seconds and indicates the position.

Refer to

- *Using the Map-based tracking assistant, page 60*

18.6 Icons used

The following table lists the icons used in Operator Client. For the icons used in the Timeline see chapter *Timeline window*, page 147.

Some of the following icons are not available in BVMS Export Player.

Toolbar icons



: Live Mode



: Playback Mode



: Audio on / off

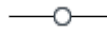

: Slider to adjust audio volume of all Image panes.



: Click to disconnect all connected unmanaged sites. Partially connected sites are not disconnected.



: Click to display / hide the toolbar of each Image pane.



: Click to display the Image pane in full-screen mode.



: Click to display the Alarm Image window (only available if alarms are pending).



: Click to display Live or Playback Mode again when the Alarm Image window is displayed.



: Click to print an image of the selected Image pane.



: Click to save an image file of the selected Image pane.



: Click to add a Favorites View.



: Click to add a bookmark.



: Click and hold to speak on the loudspeakers of an encoder with audio configured. The button is active when an encoder with audio function is selected in an Image pane.



: Click to start/stop Map-based tracking assistant.



: Click to start/stop First person view.



: Click to close all open Image panes. This icon has the same function as the shortcut for closing all Image panes.



: Click to show fewer Image pane rows.

























: Slider to change Image pane rows.































: Click to show more Image pane rows.

 : Click to access help.

Logical tree icons

-  : Operator Client is connected to a Management Server.
-  : New configuration available. Log off and log on again to accept.
-  : This state icon displays when not all communication services can be connected by the Operator Client or when there are changes within the communication interface between the Operator Client and the Management Server.
-  : For more information see the tooltip.
-  : Multiple logon with the same user name is denied
-  : State is unknown
-  : License not available
-  : Not connected
-  : Management Server is located in another time zone.
-  : Folder containing various items
-  : Folder containing various items and having assigned a map
-  : Map viewport
-  : Fixed, DVR, local storage camera
-  : ONVIF fixed camera
-  : Panoramic camera
-  : PTZ camera
-  : ONVIF PTZ camera
-  : Matrix camera
-  : VSG camera
-  , for example  : Recording
-  , for example  : Connection lost

-  , for example  : Video loss
-  , for example  : Bypassed
-  : Audio is configured
-  : State unknown
-  : Too bright
-  : Too dark
-  : Too noisy
-  : Too blurry
-  : Global scene change
-  : Reference check failed
-  : Relay
-  /  : Inputs
-  : Command Script
-  : Document
-  : Camera sequence
-  : External application
-  : Primary VRM
-  : Secondary VRM
-  : Primary Failover VRM
-  : Secondary Failover VRM
-  : Indicates a video analytics device.
-  : Indicates an unmanaged site which is not connected.
-  : Indicates an unmanaged site in another time zone than the Operator Client computer.
-  : Indicates an unmanaged site to which a connection is being established.
-  : Indicates an unmanaged site which is completely connected. This means that all devices of this site are connected.

: Indicates an unmanaged site which is partially connected. This means that not all devices of this site are connected.

: Intrusion panel.

: Area configured in an intrusion panel.

: Area is armed.

: Area is disarmed.

: Point configured in an intrusion panel and in the state unbypassed.

: Point is in the state bypassed.

: Point is in alarm state.

: Door (intrusion panel)



: Door (intrusion panel) is secured.

: Door (intrusion panel) is locked.

: Door (intrusion panel) is unlocked.

: Reader (access control)

 / : Door (access control) is locked.

 / : Door (access control) is unlocked.

: Door (access control) is secured.



: Door (access control) with unknown door states.

Image pane toolbar icons

: Forensic Search is configured.

: Forensic Search was successful.

: Forensic Search was canceled.

: Forensic Search failed.

: Maximize image pane

: Camera sequence





















-  : Camera sequence is interrupted.
-  : Camera sequence is playing.
-  : Digital zoom
-  : Transcoding is enabled.
-  : Indicates the source of the displayed recording: Primary VRM recording. On the Image pane toolbar, click to change the recording source (only available, if Secondary VRM or ANR is configured).
-  : Indicates the source of the displayed recording: Secondary VRM recording. On the Image pane toolbar, click to change the recording source.
-  : Indicates that ANR provides playback. On the Image pane toolbar, click to change the recording source.
-  : Indicates that the image pane is in synchronized playback mode.
-  : Indicates that the image pane is in unsynchronized playback mode.
-  : Indicates that the Primary Failover VRM provides playback. On the Image pane toolbar, click to change the recording source (only available, if Secondary VRM or ANR is configured).
-  : Indicates that the Secondary Failover VRM provides playback. On the Image pane toolbar, click to change the recording source.
-  : Indicates that the Encoder provides playback. On the Image pane toolbar, click to change the recording source (only available, if Secondary VRM or ANR is configured).
-  : Indicates that the Encoder provides playback. On the Image pane toolbar, click to change the recording source.
-  : Text data available
-  : Text data not available
-  : Instant playback
-  : Click to display live mode again.
-  : Manual alarm recording

Image pane icons

-  : I-frame only playback
-  : Enabled content analysis

Refer to

- *Timeline window, page 147*

18.7 Menu commands

Some of the following commands are not available in BVMS Export Player.

System menu commands		
	Playback mode / Live mode	Switches to Playback or Live Mode depending on the current state.
	Change password...	Displays a dialog box for entering a new password.
	Logoff	Exits the program and displays the dialog box for logging on.
	Exit	Exits the program.
Camera menu commands		
	Save image...	Displays a dialog box for saving an image of the selected image pane.
	Print image...	Displays a dialog box for printing an image of the selected image pane.
	Audio on / Audio off	Turns audio of the selected camera on or off.
	Record Camera	Starts recording of the selected camera. The Alarm recording Mode quality level is used.
	Instant Playback	Starts playback of the selected camera for the configured rewind time. (Not in Playback Mode)
	Reference Image...	Displays the Reference Image dialog box for the currently selected Image pane. (Not in Playback Mode)
	Close	Closes the selected Image pane.
Tools menu commands		
	Find in logbook...	Displays the Select Search Parameters and the Logbook results: dialog box. When you logged on as a user of an Enterprise User Group, the Please select a Server dialog box is displayed.
		Displays the Logbook entries for erasing text data and the Select search parameters for erasing text data dialog box.
	Erase text data from logbook...	Displays the Select search parameters for erasing text data dialog box.
	Toggle image pane bars	Hides or displays the Image pane bars.

	Show fewer Image pane rows	Decreases the number of Image pane rows displayed in the Image window.
	Show more Image pane rows	Increases the number of Image pane rows displayed in the Image window. Note: You cannot display more Image pane rows than the configured maximum, which is set by a parameter in the BVMS Configuration Client.
Timeline menu commands (Playback Mode only)		
	First recording	Moves the hairline to the oldest recording.
	Last recording	Moves the hairline to the latest recording.
	Play	Plays forward starting from the current position of the hairline.
	Pause	Stops playback at the current position. Click Play to resume.
	Reverse play	Plays backward from the current position of the hairline.
	Protect video...	Displays the Protect Video dialog box.
	Unprotect video...	Displays the Unprotect video dialog box.
	Restrict video...	Displays the Restrict Video dialog box.
	Unrestrict video...	Displays the Unrestrict video dialog box.
	Delete video...	Displays the Delete Video dialog box.
	Verify authenticity...	Displays the Verify Authenticity dialog box.
	Export video...	Displays the Export Video dialog box.
	Load exported video...	Displays a dialog box for selecting an export file. The exported file is then displayed in the Exports Tree.
Alarms menu commands		
	Accept Selected Alarms	Sets all selected alarms to the alarm state Accepted and displays them in the Alarm Image window.
	Accept All New Alarms	Sets all new alarms to the alarm state Accepted .
	Clear all accepted alarms	Sets all accepted alarms to the alarm state Cleared . The entry is removed from the Alarm List and from the Alarm Image window.

	Clear Selected Alarms	Sets all selected alarms to the alarm state Cleared . The entry is removed from the Alarm List and from the Alarm Image window.
	Workflow...	Displays the action plan for the selected alarm if available.
Extras menu commands		
	Add favorite	Saves the current Image pane pattern as a View in the Favorites tree .
	Add bookmark	Displays the Add Bookmark dialog box.
	Mute System	Turns off audio of the available Image panes and the alarm sound.
	Options...	Displays the Options dialog box.
	Restore > Default settings	Restores the settings for monitor layout, user interface and options to the factory default settings. Note: This option considers the configured maximum number of Image pane rows displayed in the Image window. The default number of Image pane rows is restored only if it does not exceed the configured maximum, which is set by a parameter in the BVMS Configuration Client.
	Restore > Last settings	Restores the settings for monitor layout, user interface and options to the last loaded settings. Note: This option considers the configured maximum number of Image pane rows displayed in the Image window. The last loaded number of Image pane rows is restored only if it does not exceed the configured maximum, which is set by a parameter in the BVMS Configuration Client.
Help menu commands		
	Display help	Displays the BVMS Online Help.
	About...	Displays a dialog box containing information on the installed system, for example the version number.

18.8 Options dialog box

Main window > **Extras** menu > **Options...** command

Allows you to configure parameters for using Operator Client.

Refer to

- *Displaying video via low bandwidth, page 97*

18.8.1**Control tab****Control tab****Dwell time for automatic sequences [s]**

Enter the required number of seconds a camera is to be displayed in an Image pane. This time is also valid for alarm sequences.

PTZ Control Speed

Move the slider to adjust the control speed for PTZ cameras.

Rewind time of instant playback [s]

Enter the amount of seconds for the rewind time of instant playback.

Display the map containing the camera of the selected Image pane

Click to activate that the map of the camera in the selected Image pane is getting the focus. The map is displayed in the **Map** window of the **Control** monitor. If the selected camera is not configured on any map, the **Map** window is cleared.

The displayed map is the first found map in the Logical Tree beginning from the root item, that contains the selected camera.

If a camera sequence is running within the selected Image pane, after each sequence step the map in the **Map** window is updated accordingly.

Start PTZ mode when selecting PTZ Image pane with mouse

Select to automatically active PTZ mode for Bosch IntuiKey keyboards for the following cases:

- When the user clicks on an Image pane displaying a PTZ camera.
- When the user drags a PTZ camera to an Image pane.

18.8.2**Display tab****Display tab****Image Pane Aspect Ratio**

For each connected monitor select the required aspect ratio for the Image panes in Operator Client. Use 16:9 for HD cameras. This setting overrides the setting that was made in Configuration Client for the initial startup of Operator Client.

Display Logical Number

Select to display the logical number of a camera in the Logical Tree.

IP address visible in print and save

Select to make the IP addresses of devices in the Logical Tree available in printed or saved images.

Text Data Position

Select the desired option for the location of the text data pane when clicking on .

Prefer hardware acceleration

After logon to Operator Client hardware acceleration is enabled by default.

To disable hardware acceleration, clear the check box.

This setting is retained after the next restart or re-logon of Operator Client.

Show diagnostic information in Image panes (enable until logoff)

Select to show decoding method in the Image pane.

The decoding method is displayed in the title bar of all open Image panes.

This setting is not persistent after the next restart or re-logout of Operator Client.

Enable colored timeline

Select to enable colored timeline for recordings. With colored timeline enabled, alarm recording, pre-alarm recording and motion recording are indicated by different colors.

Refer to

- *Timeline window, page 147*

18.8.3**Audio tab****Audio tab****Playback audio of the selected Image pane**

Select to activate audio playback for the video in the selected Image pane.

Multichannel audio playback

Select to enable simultaneous audio playback for all videos displayed in the Image panes.

Sound volume:

Move the slider to adjust the sound volume of alarm sounds.

Half Duplex

Select to enable half duplex mode for the Intercom functionality.

Full Duplex

Select to enable full duplex mode for the Intercom functionality.

18.8.4**Transcoding tab****Transcoding tab**

You can play back the recordings of a camera or view live images of a camera with Operator Client even if you have a low bandwidth network connection between BVMS and your Operator Client computer.

Transcoders do not support intelligent tracking, ROI, Intelligent Video Analytics overlays, and text data.

For using low bandwidth networks, 2 options are available:

- Hardware transcoding
- Software transcoding (only available for Live Mode)

Hardware transcoding

For hardware transcoding the VRM must be equipped with at least one transcoding device. This transcoding device is not configured in BVMS. See the VRM documentation on how to configure a transcoding device. Transcoding devices can have multiple transcoding instances.

DIVAR IP 3000 and DIVAR IP 7000 are delivered each with one preconfigured transcoding instance.

Each live stream or recording needs an own transcoding instance.

Hardware transcoding is possible only for Video IP devices from Bosch connected to a VRM. Both camera and transcoding device must be managed by the same VRM.

Software transcoding

For software transcoding you need a Mobile Video Service configured on your Management Server or your Enterprise Management Server.

In an Enterprise System only the MVS services are used that are configured in the Enterprise Management Server configuration.

Hardware (default)



Select to enable the hardware transcoder. This is the default setting.

Software

Select to enable the software transcoder.

18.9

Logical Tree window

Main window >  >  tab
or

Main window >  >  tab

Displays the hierarchical structure of all the devices your user group has access to. If you logged on to an Enterprise Management Server, the server name is displayed as a prefix to the camera name.

Only an administrator can create or change the Logical Tree in the Configuration Client.

Allows you to drag an item to the following elements of the user interface:

- Camera, map, document to an Image pane
- Each item to the **Favorites tree** window
- Map to **Map** window
- Camera to the **Monitors** window

Refer to

- *Arranging and resizing Image panes, page 41*
- *Displaying a camera in an Image pane, page 38*
- *Adding items to the favorites tree, page 63*
- *Starting a pre-configured camera sequence, page 42*
- *Displaying video via low bandwidth, page 97*

18.10

Favorites Tree window

Main window >  >  tab
or

Main window >  >  tab

You can add every item of the Logical Tree to a view in the Favorites Tree to create your own subset of the Logical Tree. At any time you can display the view or add or delete devices in a view.

When saving a view in the Favorites Tree, you save the following settings:

- The assignment of cameras or other objects to Image panes
- The Image pane pattern
- The current setting of the digital zoom
- The image section
- The selected stream (only available for Live Mode)

Refer to

- *Adding items to the favorites tree, page 63*
- *Creating/editing views, page 64*

18.11 Bookmarks window

Main window >  >  tab
or

Main window >  >  tab

You can save a time period of live view or a recording in a bookmark. A bookmark saves a start and an end time, the cameras assigned to Image window at this time, and the entire Image pane pattern. A time period of 0 seconds is possible. Bookmarks are saved in the

 pane. Deleting a bookmark does not affect the corresponding recordings. You cannot add or remove cameras from a bookmark. To change a bookmark, load it, make your changes and save it.

If a recording is deleted, the corresponding bookmark is not synchronized. If loaded, a black Image pane is displayed.

If you have logged on to an Enterprise Management Server, the camera name is displayed with the name of this camera's Management Server as a prefix.

Note: Do not add more than 4 cameras in one bookmark to avoid performance issues when loading the bookmark.

Refer to

- *Editing a bookmark, page 67*
- *Loading a bookmark, page 67*

18.12 Image window

Main window

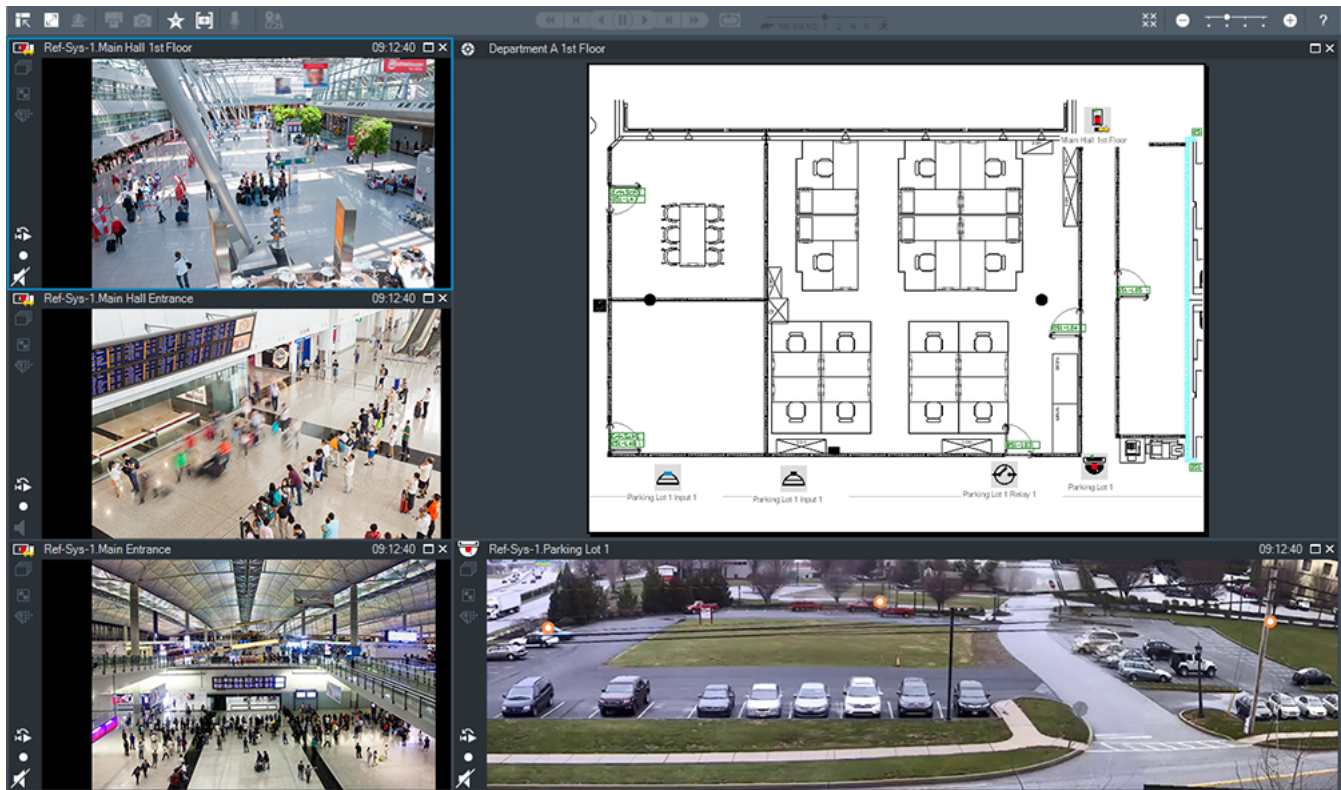

Displays a variable number of Image panes. Minimum is 1 Image pane. You can display one camera in several Image panes simultaneously.

Allows you to perform the following tasks (not all tasks are available in BVMS Export Player):

- Changing the number of displayed Image panes.
- Arranging the Image panes with high flexibility, changing the pattern of the Image panes, and saving this arrangement as a View in the **Favorites tree**.
- Toggling between Live Mode and Playback Mode (and alarm display if alarms are available).
- Switching on/off all audio sources (application must be configured for multi-channel mode).
- Starting a sequence.
- Switching on/off the Image pane toolbars.
- Performing instant playback.
- Using Intercom functionality.

Refer to

- *Changing the number of Image pane rows, page 40*
- *Arranging and resizing Image panes, page 41*

18.13 Image pane

Main window

BVMS Export Player offers only a restricted feature set.

Allows you to display:

- Live video from any video source (Live Mode only)
- Instant playback video
- Recorded video (Playback Mode only)
- Maps

- Documents (HTML files)
- Text data
- Recording source

A blue border indicates that this Image pane is selected, for example, for displaying a camera image in this Image pane.

Note: The toolbar of an image pane is only displayed, if the image pane is selected.

If you log on to an Enterprise Management Server, the camera name with the name of this camera's Management Server as a prefix is displayed in the image pane toolbar, if the image pane is selected.

Cameras in the map are displayed as hot spots. You can activate a camera in the map by double-clicking, context menu, or dragging and dropping to an Image pane.

When a PTZ camera is displayed, you can use in-window control function.

Double-click a camera in the Logical Tree to display it in the next free Image pane.

Right-click in the Image pane and click **Properties** to display the **Properties:** window. This window displays information on the camera.

The time display in the tool bar of a live Image pane always shows the local time of the displayed camera. The time display in the tool bar of a playback Image pane always shows the time of the recorded video.





Refer to

- *Icons used, page 132*
- *Displaying text data, page 94*



18.14

Search box

You can use the search box to search for an item in the Logical Tree, in the Favorites Tree and in the Bookmarks.

1. Main window >  >  or  or  tab > Right-click the desired root node or the desired item > Click **Tree search** Or:
In the Logical Tree window, the Favorites Tree window or the Bookmarks window press Ctrl+F.

The search box is displayed 

2. Type a search string representing the display name of an item.
The search is triggered immediately during typing and the first item that matches the search string is marked.
If the search string is not found, the background color of the search box changes.
3. Click  or  to mark the previous or the next matching item.
The search proceeds through all items in the tree that match the search string and not only through the items in the selected tree node.
4. Click  to close the search box.

18.15

Exports window



Main window >  >  tab

You can import exported video data, display it in an Image pane, search for particular data in it, and unload it again.

Refer to

- *Exporting video data, page 80*
- *Loading exported video, page 86*

18.16 Map window

Main window >  > Drag a map from the  to the  tab
or

Main window >  > Drag a map from the  to the  tab
Displays a site map, it cannot display video content and is not limited to a 4:3 ratio.
If a map cannot be displayed completely in the **Map** window, you can drag the map. A special cursor is displayed.



Click to get step-by-step instructions:

- *Displaying a site map, page 59*

18.17 PTZ Control window



Main window >  >  **PTZ Control** tab



The  window becomes active when a PTZ camera or a swiveling/tilting camera is displayed in the selected Image pane.
Allows you to control a camera with the corresponding functions displayed in the selected Image pane.



  Click to zoom in or out digitally. These controls are active even when a non-PTZ camera is selected.



Click an arrow or drag the joystick in the center to swivel the camera in all directions.

  Click to zoom in the picture angle (zoom angle) / zooming out the picture angle (wide angle).

  Click to set the focus near / focus far.

  Click to close the iris / open the iris.

Predefined positions:

Select an entry to move the PTZ control to the predefined position.



Click to save the current position of the PTZ camera to the selected preposition entry.

AUX commands:

Select an entry to execute this command.

18.18 Timeline window

Main window >  >  tab

Allows you to control the playback of recorded videos. You can display several cameras simultaneously.

Audio playback is only possible when you play the video in normal speed.











If you are authorized to display recorded videos, you can also listen to the accompanying audio recording.

If you select another time zone, the timeline is changed accordingly.



Allows you to navigate through recorded videos. The playback of all displayed image panes is synchronized.







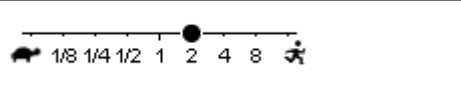

Many features enable the precise finding of scenes you are searching for.

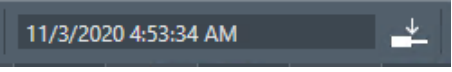
The timeline for recordings in Operator Client and BVMS Export Player displays the following information indicated by a color or hatching:

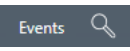
Recording	Color
Continuous recording	
Recording loss / no recording	
Protected recording	Dark grey diagonal stripes on the original color (for example: )
Restricted recording	Dark grey diagonal stripes on the original color (for example: )
Audio	
Data not yet loaded	
Search result	
Alarm recording	
Pre-alarm recording	
Motion recording	

To display colored timeline for alarm, pre-alarm and motion recording, enable colored timeline in the **Display** tab. See chapter *Display tab, page 140*.

	<p>Move the slider to adjust the playback speed for the displayed cameras.</p>
	<p>Use the controls to control the playback of the displayed cameras. From left to right:</p> <ul style="list-style-type: none"> – Jump to the oldest recording

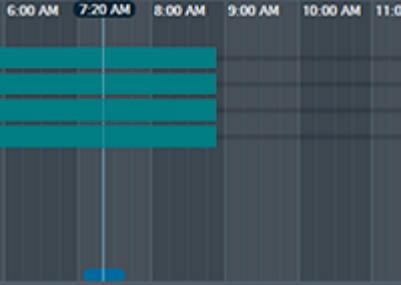
	<ul style="list-style-type: none"> – Single frame backward no matter what frame type – Play backward, you can change the playback speed with the speed slider – Pause play or backward play – Play, you can change the playback speed with the speed slider – Single frame forward no matter what frame type – Jump to the latest recording
	Enter the time for rapid positioning the hairline in the timeline.
	Click to move to the time now.
	Click to select a search type.
	Displays the selected search type, for example Video by event search .
	Click to jump to the previous search result.
	Click to jump to the next search result.
	Click to remove all search results.
	Click to display the Export Video dialog box.
	Displays all cameras displayed in the image window. If you log on to an Enterprise Management Server, the camera name is displayed with the name of this camera's Management Server as a prefix.
	Displays the timelines of the cameras in the camera list. Allows you rapid time positioning for playing the corresponding videos.

Refer to

- *Changing the playback speed, page 76*
- *Using the timeline, page 75*
- *Finding logbook entries, page 90*
- *Exporting video data, page 80*
- *Verifying the authenticity of video data, page 78*
- *Protecting or unprotecting video, page 77*

- *Restricting or unrestricting video, page 76*
- *Deleting video data, page 78*
- *Loading exported video, page 86*

19 Keyboard shortcuts

This section lists the available keyboard shortcuts for a US keyboard layout.

+ indicates that each key must be pressed simultaneously (for example, Control+z means to press the Control key and the z key simultaneously).

On your Setup CD you find an Acrobat file for printing. The name of this file is keyboard_layout_en.pdf.

19.1 General controls

Function	Shortcut key
Display Online Help	F1
Rename (for example in favorites)	F2

19.2 Playback controls

Function	Shortcut key
Play / Pause	Space
Previous frame	,
Next frame	.
Set direction to forward	Enter
Set direction to backward	Backspace
Jump to oldest recording	Home
Jump to latest recording	End
Increase playback speed	Page Up
Decrease playback speed	Page Down

19.3 Image window controls

The following keyboard shortcuts only work when the Image window has the focus.

Function	Shortcut key
Move selected Image pane	Cursor keys
Close Image pane	Delete,
Close all Image panes	Control + Delete
Show fewer Image pane rows	F7
Show more Image pane rows	F8*
Show / hide Image pane bars	F9
<p>*Note: You cannot display more Image pane rows than the configured maximum, which is set by a parameter in the BVMS Configuration Client.</p>	

20 Troubleshooting

This chapter contains information on how to handle known problems using BVMS Operator Client BVMS Export Player.

Problems with the settings in the recording control of your soundcard

Issue	Cause	Solution
<p>Feedbacks occur when using a microphone for Intercom functionality.</p>	<p>In the recording control of your soundcard the microphone must be selected, not the stereo mix (or something else). Operator Client checks its configuration file during startup and changes the settings in the recording control accordingly. This configuration file contains a default entry which might not match your system configuration. This setting is restored during each start of Operator Client.</p>	<p>Change the setting in the configuration file of Operator Client to microphone.</p>

20.1 Reestablishing the connection to a Bosch IntuiKey keyboard

1. Plug in the cable again or wait until the workstation is online.
The Off Line message disappears.
2. Press the Terminal softkey to enter BVMS.

Glossary

Alarm Image window

Image window for displaying one or more Alarm Image panes.

Alarm List

Window in Bosch Video Management System used to display a list of active alarms.

alarm priority

Each alarm is assigned a priority. Alarms can be configured to automatically display (pop up) in the Alarm Image window, based on the alarm priority. Each user's live/playback display is also assigned a priority. When alarms are received with priority higher than that of the user's display, the alarm automatically displays its alarm row in the Alarm Image window. If the Alarm Image window is not currently displayed, it automatically replaces the Live or Playback Image window on the alarm-enabled monitor.

analytics viewer

External application that is used for displaying video analytics alarms in Operator Client.

ANR

Automated Network Replenishment. Integrated process that copies missing video data from a video transceiver to the network video recorder after a network failure. The copied video data exactly fills the gap that occurred after the network failure. Hence the transceiver needs any kind of local storage. The recording capacity on this local storage is calculated with the following formula: $(\text{network bandwidth} \times \text{estimated network downtime} + \text{safety margin}) \times (1 + 1/\text{backup speed})$. The resulting recording capacity is required because the continuous recording must continue during the copy process.

area

A group of detection devices connected to the security system.

authenticity

State of a recorded video that indicates its originality. That means, the recorded video is not manipulated.

bookmark

Used for storing a time period of live or recorded video. This allows for tagging particular scenes for later investigation. Additionally you can share your investigation results with other users by exporting a bookmark.

bypass

Selectively remove points from the security system. A point may be bypassed in order to arm the perimeter with a window open.

camera sequence

A list of cameras that are displayed one after the other. Each camera is displayed for a specific time (dwell time). There are two types of sequences: predefined and automatic. Predefined sequences are defined by the administrator. Icons for these sequences are located in the Logical Tree. Automatic sequences are created when you drag a multiple selection or a folder from the Logical Tree to an Image pane or a decoder. All cameras in this folder or selection sequences in the Image pane. You can create your own sequences by creating a folder in your Favorites Tree.

Dewarping

The use of software to convert a circular image from a fisheye lens with radial distortion to a rectilinear image for normal viewing (dewarping is the correction of distortion).

DNS

Domain Name System. A DNS server converts a URL (www.myDevice.com, for example) into an IP address on networks that use the TCP/IP protocol.

Document

The document files that are supported by BVMS are HTM, URL, MHT, HTML, TXT.

dual authorization

Security policy that requires two different users to log on to the Operator Client. Both the users must be member of a normal Bosch Video Management System user group. This user group (or these user groups if the users are members of different user groups) must be part of a dual authorization group. A dual authorization group

has its own access rights within Bosch Video Management System. This dual authorization group should have more access rights than the normal user group that the user belongs to. Example: User A is member of a user group called Group A. User B is member of Group B. Additionally a dual authorization group is configured with Group A and Group B as members. For the users of Group A, dual authorization is optional, for users of Group B it is mandatory. When user A logs on, a second dialog box for confirming the logon is displayed. In this dialog box, a second user can log on if he is available. If not, user A can continue and start the Operator Client. He then has only the access rights of Group A. When user B logs on, again a second dialog box for logging on is displayed. In this dialog box, a second user must log on. If not, user B cannot start the Operator Client.

duplex

Term used to define the direction of data transmission between two parties. Half-duplex allows data transmission in both directions but not simultaneously. Full-duplex allows simultaneous data transmission.

Dwell time

Preset amount of time a camera is displayed in an Image window until the next camera is displayed during a camera sequence.

Edge dewarping

Dewarping performed in the camera itself.

Encoder

Changes an analog stream to a digital stream, e.g., to integrate analog cameras in a digital system like Bosch Video Management System. Some encoders can have a local storage like a flash card, a USB hard disk, or they can store their video data on iSCSI devices. IP cameras have an encoder built in.

Enterprise Account

Enterprise Account is an authorization that enables a user of Operator Client to connect to the devices of a Management Server being part of an Enterprise System. In an Enterprise Account, all permissions for the devices of this Management Server are configured. Operator Client can simultaneously connect to all

Management Server computers that are part of this Enterprise System. This access is either controlled by the membership to an Enterprise User Group, and is controlled by the device permissions configured in the Enterprise Account for this Management Server.

Enterprise System

Enterprise System is a feature of Bosch Video Management System that allows a user of Operator Client to access multiple Management Server computers simultaneously.

Enterprise User Group

Enterprise User Group is a user group that is configured on an Enterprise Management Server. Enterprise User Group defines the users that are authorized to access multiple Management Server computers simultaneously. Defines the operating permissions available for these users.

erase

The right of erasure in the GDPR (General Data Protection Regulation) provides that the data subject has the right to request erasure of personal data related to them on any one of a number of grounds within 30 days.

Event

A circumstance or state that is linked to an alarm and/or an action. Events can arise from many sources such as cameras, archivers, directories, digital inputs, etc. They can include start-recording states, loss of signal states, disk full messages, user logons, digital input triggers, etc.

Failover VRM

Software in the BVMS environment. Takes over the task of the assigned Primary VRM or Secondary VRM in case of failure.

Favorites Tree

Hotspot

Mouse sensitive icon on a map. Hotspots are configured in Configuration Client. Hotspots can be for example cameras, relays, inputs. The operator uses it for localizing and selecting a device in a building. If configured, hotspots can display a blinking background color when a specific state event or alarm occurs.

Image pane

Used for displaying live or recorded video of a single camera, a site map, a document, a sequence, a monitor group, an external application or a map viewport.

Image pane pattern

Arrangement of Image panes.

Image window

Container for Image panes, structured by an Image window pattern.

Instant playback

Plays the recorded image of the selected camera in an Image pane on the live screen. The start time (number of seconds in the past, or rewind time) can be configured.

Intelligent Tracking

Intelligent Tracking is a software process running on a camera that allows the camera to follow a selected object.

Intelligent Video Analytics

Algorithm that detects specific properties and the behavior of objects in a scene monitored by a video camera and from this generates alarm events that, in turn, can be processed in a CCTV system. Recording with Intelligent Video Analytics settings activated is a precondition to be able to selectively and quickly search through video material later. Intelligent Video Analytics makes it possible to capture and evaluate directional movement of objects in such a way that false alarms are prevented to a large extent. Intelligent Video Analytics adapts automatically to changing environmental conditions and is therefore largely non-sensitive to perturbing influences such as rain and tree movement. Especially when used for forensic search, Intelligent Video Analytics allows for filtering moving objects by their color specifications. With the aid of Intelligent Video Analytics algorithm extensive video material can be searched selectively for objects with specific color properties.

Intercom functionality

Used to talk on the loudspeakers of an encoder. This encoder must have audio-in and audio-out. The Intercom functionality can be granted per user group.

intrusion control panel

Generic name for the core device in a Bosch intrusion (burglary) security system. Keypads, modules, detectors, and other devices connect to the control panel.

iSCSI

Internet Small Computer System Interface. Protocol that manages storage via a TCP/IP network. iSCSI enables access to stored data from everywhere in the network. Especially with the advent of Gigabit Ethernet, it has become affordable to attach iSCSI storage servers simply as remote hard disks to a computer network. In iSCSI terminology, the server providing storage resources is called an iSCSI target, while the client connecting to the server and accessing the resources of the server is called iSCSI initiator.

Logbook

Container for logging all events in Bosch Video Management System.

Logical number

Logical numbers are unique IDs assigned to each device in the system for ease of reference. Logical numbers are only unique within a particular device type. Typical use of logical numbers are Command Scripts.

Logical Tree

Tree with a customized structure of all the devices. The Logical Tree is used in the Operator Client to select cameras and other devices. In the Configuration Client, the "Full Logical Tree" is configured (on the Maps and Structure page) and tailored for each user group (on the User Groups page).

Management Server

BVMS server managing devices.

monitor group

A set of monitors connected to decoders. The monitor group can be used for alarm processing in a given physical area. For example, an installation with three physically separated

control rooms might have three monitor groups. The monitors in an monitor group are logically configured into rows and columns and can be set to different layouts, e. g. full-screen or quad view.

MOV

File extension of the default video format used by QuickTime Player from Apple.

MP4

MP4 is a digital multimedia container format most commonly used to store video and audio, but it can also be used to store other data such as subtitles and still images. MP4 files are supported by most software media players.

No-touch deployment

Method for automatic downloading, installing and running .NET applications without changing the registry or shared system components. With Bosch Video Management System, no-touch deployment is used for updating the Operator Clients from the Management Server. The update takes place if a new version is stored on the Management Server and when each user is logging on to the Operator Client. If you work with one Operator Client against multiple Management Server computers, no-touch deployment uses only the software version stored on the Management Server where the Operator Client has last logged on successfully. When you try to log on to another Management Server with a different application version, this one displays the Management Server as not online because the software versions do not match.

Operator Client

Component of Bosch Video Management System that provides the user interface for system monitoring and operation.

Operator Client workstation

Computer in the Bosch Video Management System environment for viewing live and playback video and for configuration tasks. Operator Client is installed on this computer.

Panoramic camera

Camera with a 360° or 180° view angle.

Playback Mode

Feature of Operator Client. Used to playback and search through archived videos.

point

A detection device connected to the security system. Points show on the keypad individually and with custom text. The text might describe a single door, motion sensor, smoke detector, or an protected space such as UPSTAIRS or GARAGE.

PTZ camera

Camera with pan, tilt, and zoom function.

Reference image

A reference image is continuously compared with the current video image. If the current video image in the marked areas differs from the reference image, an alarm is triggered. This allows you to detect tampering that would otherwise not be detected, for example if the camera is turned.

Rewind time

Number of seconds when an Image pane is switched to instant playback.

ROI

Region of Interest. Intended use of ROI is to save bandwidth when zooming into a section of the camera image with a fixed HD camera. This section behaves like a PTZ camera.

Secondary VRM

Software in the BVMS environment. Ensures that the recording performed by one or multiple Primary VRMs is additionally and simultaneously performed to another iSCSI target. The recording settings can deviate from the settings of the Primary VRM.

Server Lookup

Access method for a user of Configuration Client or Operator Client to sequentially connect to multiple system access points. A system access point can be a Management Server or an Enterprise Management Server.

Site

User-created entity for grouping related system resources together for ease of viewing and management. Typically, a site corresponds to a physical location, like a building or a floor, but it

may be used to represent any concept. It consists of a Management Server, usually Configuration Client and multiple Operator Client installations.

TCP

Transmission Control Protocol. Connection-oriented communication protocol used to transmit data over an IP network. Offers a reliable and ordered data transmission.

Timeline

Part of the Bosch Video Management System user interface. Displays lines as graphical representations of the recordings of the selected cameras. The Timeline allows you to navigate through recorded videos.

UDP

User Datagram Protocol. A connectionless protocol used to exchange data over an IP network. UDP is more efficient than TCP for video transmission because of lower overhead.

unmanaged site

Item of the Device Tree in BVMS that can contain video network devices like Digital Video Recorders. These devices are not managed by the Management Server of your system. The user of Operator Client can connect to the devices of an unmanaged site on demand.

User group

User groups are used to define common user attributes, such as permissions, privileges and PTZ priority. By becoming a member of a group, a user automatically inherits all the attributes of the group.

UTC

Universal Time Coordinated

Video Analytics

Video analytics is a software process that compares a camera image with the stored images of specific persons or objects. In case of a match, the software triggers an alarm.

Video Streaming Gateway (VSG)

Virtual device that allows integrating Bosch cameras, ONVIF cameras, JPEG cameras, RTSP encoders.

view

Collection of image panes that you can recall for instant live viewing. Sequences cannot be part of a view.

VRM

Video Recording Manager. Software package in Bosch Video Management System which manages storing video (MPEG-4 SH++, H.264 and H.265) with audio data and metadata on iSCSI devices in the network. VRM maintains a database containing the recording source information and a list of associated iSCSI drives. VRM is realized as a service running on a computer in the Bosch Video Management System network. VRM does not store video data itself but distributes storage capacities on iSCSI devices to the encoders, while handling load balancing between multiple iSCSI devices. VRM streams playback from iSCSI to Operator Clients.

Index

A	
accept new configuration	35
accessing the Help	8
add bookmark	66
additional data	
text data	95
alarm camera	
analog monitor	101
Alarm Images window	42
alarm map	59
alarm recording	42
find	74
NVR recordings	42
VRM recordings	42
alarm sequence	128
application windows	123
area	135
arm	109, 110, 111
audio	44, 48
Audio Intercom functionality	49, 141
authentication	79
authenticity	147
automatic alarm popup behavior	24
automatic display of alarms	24
automatic pop-up alarm	123, 130
automatic sequence	43
B	
blinking device icon	59
bookmark	63
add	66
display	67
edit	63, 67, 143
load	67
save	66
Bosch IntuiKey keyboard	
analog mode	121
Command Mode	120
digital mode	116
icons	120
Bosch Video Management System	
Online Help	8
BVMS Export Player	68, 70, 81
bypass	
point	109
C	
camera round	42, 43
camera sequence	42, 43
automatic	43
pre-configured	42
CCTV keyboard	113
change password	35
check authenticity	79
color	147
Command Mode	120
Compatibility Mode	25
connection issues	54
D	
data sheet	14
decline new configuration	35
delete user	35
delete video	147
digital keyboard	113
digital zoom	45, 64
disarm	109, 110, 111
displaying	
screens	37
dome camera	56, 57
DWF files	
initial view	59
E	
edit bookmark	67
Enterprise System	17
entire screen	46
exit	
Operator Client	35
export	
split	81
video	81, 147
F	
Favorite	64, 65, 66
find alarm recording	74
find text data	74, 95
find video	74
finding	
information in the Help	8
Logbook entries	90, 91, 96
force arm	109, 110, 111
Forensic Search	87
full-screen mode	46
G	
general settings	139
H	
Hairline	147

HD camera	140	online application Help	8
help	8, 9	Operator Client	
HTML files	143	quit	35
I		start	34
icons	132	options	139
Bosch IntuiKey keyboard	120	P	
Image pane	38, 41, 46, 144	panoramic camera	
in-window PTZ	56	viewing modes	26, 39
image section	45, 64	password change	35
Image window	143	playback	125
import		playback control	
video data	87	jump to latest recording	147
import exported video	87	jump to oldest recording	147
initial view		pause	147
DWF files	59	play	147
instant playback	45, 47	play backward	147
instant replay	47	single frame backward	147
Intercom functionality	49	single frame forward	147
intrusion panel	135	Playback Mode	125
IntuiKey keyboard	113	playback video	143
in-window PTZ	56, 145	point	
K		bypass	109
KBD Universal XF keyboard	113	point in time	147
L		pre-configured sequence	42
Live Mode	123, 146	printing the Help	9
live video	123, 143	protect video	147
load		PTZ blocking	50
video data	87	PTZ camera	56, 57
Logbook	90, 91, 93, 96	PTZ control	146
Logical Tree		blocking	50
search	40	push-to-talk	49
M		Q	
Management Server	14, 17	quit	
manual recording	25, 42	Operator Client	35
map	143	R	
blinking device icon	59	recording quality	42
colored device icon	59	recording source	99, 144
map viewport	60	reference image	50
Map-based tracking assistant	59, 60, 130	refuse new configuration	35
multichannel	44	Release Notes	14
N		remote export	25, 81
new configuration available	35	remove user	35
NVR	14	resize	41
NVR recordings		restrict video	76
alarm recording	42	S	
O		save bookmark	66
offline	35	search	
		Logical Tree	40

search for alarm recording	74	view camera	38
search for motion	147	viewing	
search for recorded video	74	screens	37
search for text data	74, 95	viewing modes of panoramic camera	26, 39
searching for Logbook entries	90, 91, 96	VRM recordings	
sequence	42, 43	alarm recording	42
shortcuts	150	Z	
single frame		ZIP export	83
backward	147		
forward	147		
smart motion search	147		
sound	123		
specific event	147		
split export	81		
start			
Operator Client	34		
stream selection	51		
switch			
panoramic viewing mode	39		
system requirements	14		
T			
TCP	54		
text data			
find	74, 95		
time zone	12, 91, 93, 124, 129, 147		
Timeline	125, 147		
toggle	42		
toolbar	46		
transcoded video	53, 98		
U			
unmanaged site access	91		
update reference image	50		
used icons	132		
user			
delete	35		
remove	35		
V			
VCA			
disable	47, 87		
enable	47, 87		
verify authenticity	79		
video			
export	81		
find	74		
video data			
import	87		
load	87		
View	64		

Bosch Security Systems B.V.

Torenallee 49

5617 BA Eindhoven

Netherlands

www.boschsecurity.com

© Bosch Security Systems B.V., 2023

Building solutions for a better life.

202310251130