

# DICENTIS

DICENTIS Wireless



## Table of contents

<b>1</b>	<b>Safety</b>	<b>4</b>
<b>2</b>	<b>About this manual</b>	<b>5</b>
<b>2.1</b>	Intended audience	<b>5</b>
<b>2.2</b>	Copyright and disclaimer	<b>5</b>
<b>2.3</b>	Document history	<b>5</b>
<b>3</b>	<b>System overview</b>	<b>7</b>
<b>3.1</b>	Security measures	<b>7</b>
<b>3.2</b>	GUI languages	<b>7</b>
<b>4</b>	<b>First use configuration</b>	<b>8</b>
<b>4.1</b>	Login	<b>9</b>
<b>4.2</b>	Wireless Device initialization	<b>10</b>
<b>5</b>	<b>Web browser interface</b>	<b>12</b>
<b>5.1</b>	Manage discussion	<b>15</b>
<b>5.2</b>	Prepare discussion	<b>16</b>
<b>5.3</b>	Voting	<b>18</b>
<b>5.4</b>	System settings	<b>20</b>
<b>5.4.1</b>	Upgrade	<b>20</b>
<b>5.4.2</b>	Users	<b>22</b>
<b>5.4.3</b>	Audio	<b>22</b>
<b>5.4.4</b>	Equalizer	<b>23</b>
<b>5.4.5</b>	Cameras	<b>23</b>
<b>5.4.6</b>	Licensing	<b>24</b>
<b>5.4.7</b>	Network and general settings	<b>25</b>
<b>5.4.8</b>	Seats	<b>28</b>
<b>5.4.9</b>	Date and time	<b>29</b>
<b>5.4.10</b>	Carrier Management	<b>29</b>
<b>5.5</b>	Participants	<b>31</b>
<b>5.6</b>	Power	<b>33</b>
<b>5.7</b>	Battery & Signal	<b>33</b>
<b>5.8</b>	Logging	<b>34</b>
<b>5.9</b>	System info	<b>34</b>
<b>5.10</b>	Logout	<b>34</b>
<b>6</b>	<b>Wireless Access Point LED behavior</b>	<b>35</b>
<b>7</b>	<b>Troubleshooting</b>	<b>37</b>
<b>7.1</b>	Customer service	<b>37</b>
<b>7.2</b>	Troubleshooting table	<b>37</b>

## 1

## Safety

Prior to installing or operating products, always read the Important Safety Instructions which are available as a separate multilingual document: Important Safety Instructions (Safety\_ML). These instructions are supplied together with all equipment that can be connected to the mains supply.

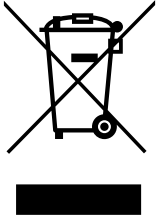

### Old electrical and electronic appliances

Electrical or electronic devices that are no longer serviceable must be collected separately and sent for environmentally compatible recycling (in accordance with the European Waste Electrical and Electronic Equipment Directive).

To dispose of old electrical or electronic devices, you should use the return and collection systems put in place in the country concerned.

## 2 About this manual

The purpose of this manual is to provide information required for configuring, preparing, and managing the DICENTIS Wireless Conference System. This manual describes in general how to use the Wireless Access Point (DCNM-WAP) web browser interface. If required, refer to the installation manual and Wireless Devices user manual of the DICENTIS Wireless Conference System.

This manual is available as a digital document in the Adobe Portable Document Format (PDF).

Refer to the product related information on: [www.boschsecurity.com](http://www.boschsecurity.com).

### 2.1 Intended audience

This manual is intended for people who have the authorizations to configure, prepare and/or manage a DICENTIS Wireless Conference System.

### 2.2 Copyright and disclaimer

All rights reserved. No part of this document may be reproduced or transmitted in any form by any means, electronic, mechanical, photocopying, recording, or otherwise, without the prior written permission of the publisher. For information on getting permission for reprints and excerpts, contact Bosch Security Systems B.V..

The content and illustrations are subject to change without prior notice.

### 2.3 Document history

Release date	Documentation version	Reason
2015-03	V1.0	1 <sup>st</sup> edition.
2016-07	V2.0	Sections updated: 4, 4.1, 4.2, 5, 5.2, 5.3, 5.4, 5.4.1, 5.4.2, 5.4.4, 5.4.5, 5.4.6, 5.4.7, 5.4.9, 5.5, 5.6, 5.7, 5.8, 5.9, 6, 7.2. New section: 5.4.10.
2017-08	V2.1	Sections updated: 4, 5.2, 5.4.7, 7.2. New section: 3.1.
2018-02	V2.2	Sections updated: 5.3, 5.5.
2018-08	V2.3	Sections updated: 5.4.5, 5.4.8.
2020-05	V2.4	Sections added: – <b>GUI languages</b> Sections updated: – <b>Voting:</b> with information about voting without pressing the present button.

Release date	Documentation version	Reason
		<ul style="list-style-type: none"><li data-bbox="1088 242 1439 455">– <b>Upgrade:</b> with information about how to download the Open Source Software license terms for the system devices.</li><li data-bbox="1088 459 1439 634">– <b>System info:</b> completed with additional available information about API version and OSS license terms.</li></ul>
2023-12	V2.5	Section updated: <ul style="list-style-type: none"><li data-bbox="1088 693 1439 906">– <b>Troubleshooting:</b> with information on how to proceed when battery is not charging or charging takes longer than expected.</li></ul>

### 3 System overview

The DICENTIS Wireless Conference System is a “standalone” IP based system. It uses WiFi IEEE 802.11n for wireless distribution and processing of audio and data signals.

For an overview of the system, please refer to the DICENTIS Wireless Conference System installation manual.

#### 3.1 Security measures

The installer takes care of security measures to prevent improper use of the system via the Internet and local wired or wireless networks.

Consider the following items to increase security:

- Change the default admin password
- Change the default SSID
- Prevent unauthorized access to the DCNM-WAP
- Prevent unauthorized physical and logical access to the wired Ethernet connection of the DCNM-WAP
- Place the DCNM-WAP in a separate VLAN
- If you use a third-party or external network, you should use a firewall and VPN or another safe network protocol for the external connection to prevent unauthorized access

#### 3.2 GUI languages

The DICENTIS Wireless Conference System has the following GUI languages:

	ar	cs	de	en	el	es	fi	fr	hu	id	it	ja	ko	nl	pl	pt	pt-BR	ru	th	tr	vi	zh-CN	zh-TW
Web browser	•	•	•	•	•	•	•	•	•	•	•	•	•	•	•	•	•	•	•	•	•	•	•
Discussion device with touchscreen	•	•	•	•	•	•	•	•	•	•	•	•	•	•	•	•	•	•	•	•	•	•	•

## 4 First use configuration

The Wireless Access Point (DCNM-WAP) includes a web browser interface wizard to help you with the initial configuration of the DICENTIS Wireless Conference System.

### Web browser

The DCNM-WAP web browser interface is compatible with and optimized for the latest version of these web browsers:

- Internet Explorer
- Safari
- Firefox
- Opera
- Chrome

### Preconditions

- All used system devices are prepared and installed as described in the DICENTIS Wireless Conference System installation manual. Also see *System overview, page 7*.
- The Wireless Access Point (DCNM-WAP) is powered on.
- On a Windows PC/laptop, make sure:
  - Bosch DNS-SD is installed. Bosch DNS-SD is on the DVD supplied with the DCNM-WAP and can be downloaded from the relevant product page on: [www.boschsecurity.com](http://www.boschsecurity.com)
  - a dynamic IP address has been assigned to the laptop/PC. If the laptop/PC has a static IP address, the web browser interface will not work correctly.
- On any other device:
  - make sure Apple Bonjour is installed. Apple Bonjour can be downloaded from the Apple website. Apple Bonjour is required if you want to enter the (link-local) default web address of the DCNM-WAP.  
**Note:** Apple Bonjour or Bosch DNS-SD are not available for Android.
- When using WiFi, make sure both 2.4 GHz and 5 GHz are available on your device.

### How to connect the DCNM-WAP

1. To connect directly to the DCNM-WAP using WiFi:
  - Use the WiFi discovery function of your PC/Tablet, and select the DICENTIS Wireless Conference System **Network name (SSID): Bosch DICENTIS**
  - Enter the **WPA2 Key: dcnm-wap**
  - Wait until the connection is made.
  - Open your web browser and type: **http://dcnm-wap.local**, in Android type: **http://172.27.2.1**
2. To connect directly to the DCNM-WAP using wired (Peer-to-peer connection, link local):
  - Open your web browser and type: **http://dcnm-wap.local**  
**Note:** This is not supported on Android, because Android does not support Bonjour and DNS-SD.
3. To connect via a network infrastructure to the DCNM-WAP (DHCP/DNS):
  - Consult the network owner to obtain the hostname or IP address of the DCNM-WAP.



### Initial setup

- When the DCNM-WAP is used for the first time (or set to factory defaults) the wizard is shown.
- In **Lets get started**, select the required language for the web application, and then click **Setup device**.
- In **Country**, select the **Country**, the **Date**, the **Time**, the **Time zone**, and then click **Next**:



### Caution!

When a country is selected the system automatically selects the correct WIFI settings for that country. Do not select a country other than the country where the DCNM-WAP is used. WIFI conformity is determined per country, and it is illegal to use WIFI settings that have not been approved for a country.

- In **User**, define a password for the administrator user, and add a user for daily business use with the required user rights (see *Users, page 22*). It is not recommended to use the administrator user for daily business. Click **Next**.
- In **Wifi**, the **Network name (SSID)**, **WPA2 Key**, and **Hostname** are intentionally left blank for security reasons. Enter a unique name, especially if there are multiple systems in one area or a redundant WAP is being used. When changing these values, the following restrictions apply:
  - The length of the **Network name (SSID)** must be between 1 and 25 characters. These characters are allowed: A-Z, a-z, 0-9, \_, space.
  - The length of the **WPA2 Key** must be between 8 and 64 characters.
  - The length of the **Hostname** must be between 1 and 63 characters. These characters are allowed: A-Z, a-z, 0-9, -
  - The **Network name (SSID)**, **WPA2 Key**, and **Hostname** must be unique and are mandatory.
  - Click **Setup device** to save these settings.
- The wizard is completed and the WAP reboots.
- The login page is then displayed.

## 4.1

### Login

Multiple users can log in to the system at the same time, providing they log in on separate web browsers or separate devices (tablet, laptop or PC).

#### Login to the web browser interface application

1. Enter the **Username** and **Password**.
  - The default setting for a new or factory reset system is: username: 'admin' with an empty password.
2. Select the preferred **Language** from the dropdown list, and then click **Login**.
  - The default language is the language of the operating system running the browser.
  - If the default language is not available, English is automatically selected.
3. If the login is successful, the web browser interface homepage is displayed. See *Web browser interface, page 12*.

## 4.2 Wireless Device initialization

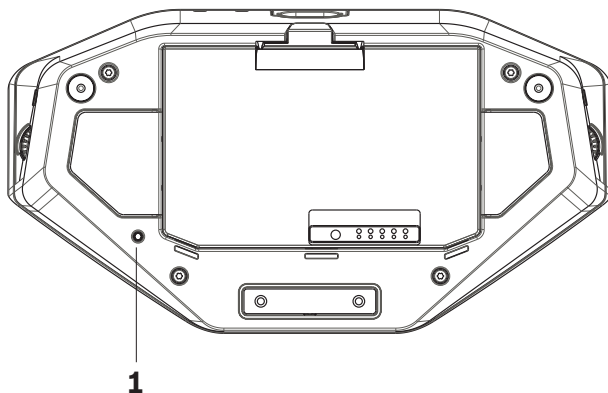

**Figure 4.1:** DCNM-WD and DCNM-WDE bottom view

### Preconditions Wireless Devices and DCNM-WAP

- The DCNM-WAP must be powered on and configured. Refer to *First use configuration*, page 8, if required.
- All Wireless Devices must be:
  - placed within the range of the DCNM-WAP.
  - powered on (by inserting the Battery Pack and pressing the microphone request button).
  - de-initialized.

A Wireless Device is de-initialized when all LEDs on the Wireless Devices are on. To de-initialize a Wireless Device, use a thin screwdriver to press and hold in the **De-init** button on the base of the Wireless Device (1) until all LEDs are on.

### Preconditions web browser interface

- The logged in user must have the access right: **Configure**.

### Initialization

1. In the web browser interface, select the **System settings > Seats** page. Refer to *Seats*, page 28.
2. Enable the **Subscription mode**.

### Notice!

A PC running Windows 10 might be subscribed to the DICENTIS audio WiFi network accidentally. This will cause audio disturbance.

When subscription on the DCNM-WAP is enabled, do not subscribe a PC running Windows 10.



3. Press the microphone request button of a Wireless Device.
  - The Wireless Device starts subscribing, and the LED-bar above the microphone request button starts alternating between red and green.
  - When the LED-bar is off, the Wireless Device is subscribed.
4. Wait until a Wireless Device is subscribed before subscribing the next Wireless Device. Subscribing a Wireless Device before the previous device has finished subscribing will result in overlap.
  - In overlap, the subscription is disabled for 2 minutes, which is shown in the web browser interface application.
  - Starting subscription before the current overlap time period has finished will restart the overlap time period of two minutes.

- 
- If another WiFi system is in subscription mode, this will also activate the overlap period in the DCNM-WAP.
5. When all Wireless Devices are subscribed, disable the **Subscription mode** in the web browser interface application. The subscription mode will automatically switch off when no device is subscribed within two minutes.

## 5 Web browser interface

Depending on user rights and the licenses installed, the following buttons are displayed on the web browser interface homepage:

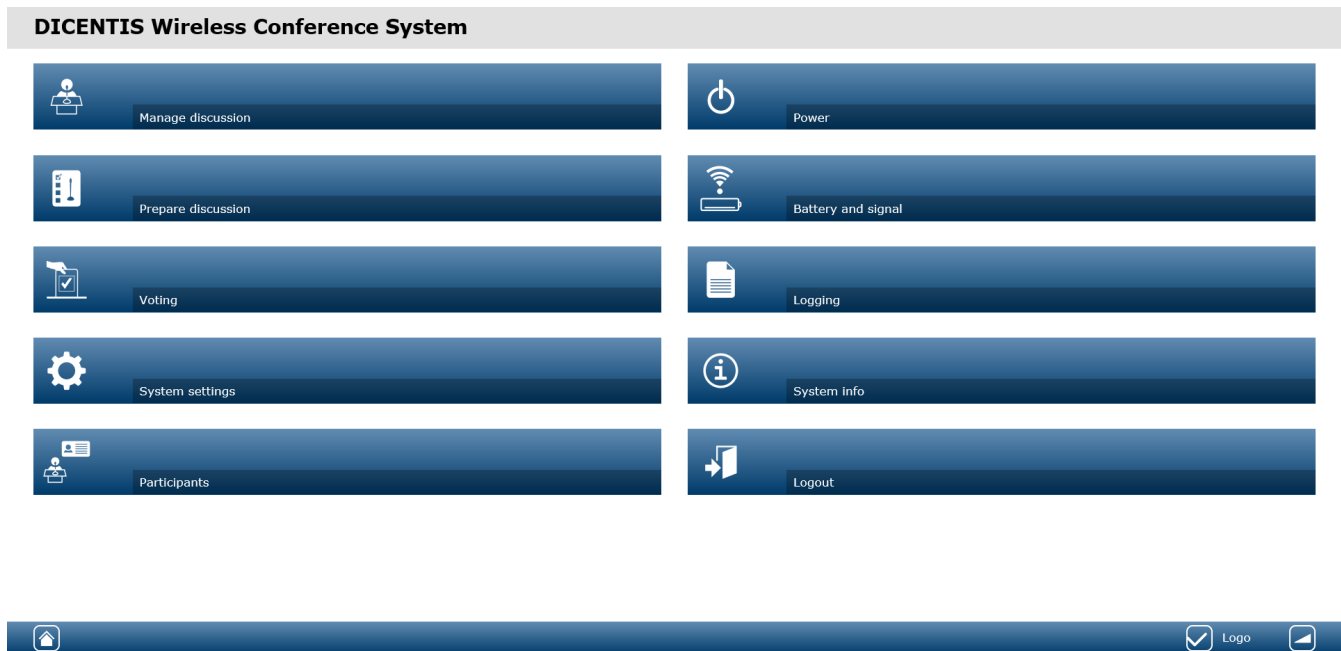

















Figure 5.1: web browser interface homepage (typical setup)

Button	Description	Access right
 <b>Manage discussion</b>	To manage a discussion. See <i>Manage discussion</i> , page 15.	<b>Manage meeting</b>
 <b>Prepare discussion</b>	To prepare a discussion. See <i>Prepare discussion</i> , page 16.	<b>Prepare meeting</b>
 <b>Voting</b>	To use voting. See <i>Voting</i> , page 18.	<b>Manage meeting</b>
 <b>System settings</b>	To configure the system. See <i>System settings</i> , page 20.	<b>Configure or Modify users</b>
 <b>Participants</b>	To set the identification mode for the system: <ul style="list-style-type: none"> <li>– To create participants.</li> <li>– To give participants an NFC-ID.</li> <li>– To assign seats to participants.</li> </ul> See <i>Participants</i> , page 31.	<b>Prepare meeting</b>

Button	Description	Access right
 <b>Power</b>	<ul style="list-style-type: none"> <li>- <b>On:</b> Activates the DCNM-WAP. The Wireless Devices have to be switched on manually. See <i>Power up</i> in the <i>User manual</i>.</li> <li>- <b>Standby:</b> Switches off the subscribed devices and sets the DCNM-WAP to Standby. The web browser interface of the DCNM-WAP can still be accessed. Switching from 'Standby' to 'On' automatically re-enables the Wireless Devices (use this option when you want to pause the meeting).</li> <li>- <b>Off:</b> Switches off the subscribed devices. The web browser interface of the DCNM-WAP can still be accessed, but the DCNM-WAP stops transmitting (use this option when you want to end the meeting).</li> <li>- <b>Cancel:</b> Cancels the <b>Power</b> pop-up window.</li> </ul>	<b>Prepare system</b>
 <b>Battery and signal</b>	Overview of: <ul style="list-style-type: none"> <li>- Wireless Devices battery condition.</li> <li>- WiFi signal strength status.</li> <li>- Range test button and results.</li> </ul> See <i>Battery &amp; Signal</i> , page 33.	<b>Configure or Prepare system</b>
 <b>Logging</b>	Overview and saving of system events. See <i>Logging</i> , page 34.	<b>Configure</b>
 <b>System info</b>	System overview. See <i>System info</i> , page 34.	<b>Configure</b>
 <b>Logout</b>	Exits the discussion application and returns you to the login page. See <i>Logout</i> , page 34.	None
 <b>Home</b>	Returns you to the web browser interface homepage.	None
 <b>Back</b>	Returns you to the previous page.	None
  <b>Logo</b>	Select the logo checkbox to display the logo on the Wireless Device Extended (DCNM-WDE) touch screen. When the logo is displayed the speaker list is hidden. The logo can be changed via the <b>System settings &gt; Upgrade</b> page. Use this feature, for example, before starting the meeting or when you want to take a break.	<b>Configure or Manage meeting</b>

Button	Description	Access right
 <b>Master volume</b>	Opens the master volume control slider. Controls the Wireless Devices loudspeaker volume.	<b>Configure or Manage meeting</b>

### RESTful Application Program Interface (API)

The DICENTIS Wireless Conference System has a RESTful API that has the following functions:

**Note:** A RESTful API is an Application Program Interface that uses HTTP requests to GET, PUT, POST and DELETE data.

#### Speakers

This function gives control of the speaker's microphones. A list of all active speakers can be retrieved. Speakers can be added to and removed from the speakers list. Possible applications that could use this function are:

- third party Pan Tilt Zoom (PTZ) camera systems.
- web-casting and recorder solutions requiring microphone information.
- synoptic layouts for microphone management.

#### Waiting-list

This function gives control of the waiting list. A list of all waiting speakers can be retrieved. Speakers can be added to and removed from the waiting list.

Possible applications that could use this function are:

- third party Pan Tilt Zoom (PTZ) camera systems.
- web-casting and recorder solutions requiring microphone information.
- synoptic layouts to enable and disable microphones.

#### System

This function gives the possibility to:

- set the system to standby.
- recover the system from standby.

Turn all devices off

#### Voting

1. Voting can be configured.
2. Voting can be started and stopped.
3. Individual voting results can be retrieved via the API.

For more information on the Application Program Interface:

- refer to the API manual, which can be downloaded at: <https://licensing.boschsecurity.com/software>, or
- access the information stored on the (DCNM-WAP): <URL>/REST\_API.html
  - <WAP hostname or IP>/REST\_API.html

#### Refer to

- *Login*, page 9
- *Users*, page 22
- *Seats*, page 28
- *Power*, page 33

## 5.1 Manage discussion

### Preconditions:

- The logged on user must have the access right: **Manage meeting**.



Click the **Manage discussion** button on the homepage to open the **Manage discussion** page.

### Manage discussion means:

- View discussion list: waiting and speaking participants.
- Add and remove waiting and speaking participants.
- Shift waiting participants
- Master volume control.



### Manage discussion

This page shows the discussion list, which has separate lists for waiting and speaking participants.

- Click the **+** button to select and add participants or seats to the **Waiting** list or **Speakers** list.
- Click the recycle bin to remove a participant or seat from the **Waiting** list or **Speakers** list.
- Use the **Shift** button, to shift participants or seats from the **Waiting** list to the **Speakers** list. If the **Speakers** list is full, the longest speaking participant (or seat) is removed from the list.
- Click the **Stop and remove all** button to remove all waiting speakers and speakers from the lists.

The maximum number of participants or seats that can be added to the **Speakers** list is set on the prepare discussion page. See *Prepare discussion, page 16*.

**Note:** The maximum number of seats does not include the chairperson's seat, because the chairperson's microphone can always be activated.



### Master volume control button

Click the master volume control button to adjust the audio output level of the Wireless Devices loudspeaker and Wireless Access Point.

## 5.2 Prepare discussion

### Preconditions:

- The logged on user must have the access right: **Prepare meeting**.

Click the **Prepare discussion** button on the homepage to open the **Prepare discussion** page.

### Prepare discussion means:

- Define the discussion settings.

### Prepare a discussion

- **Discussion mode:** Click a discussion mode at the top of the page to select it. The button will be highlighted grey, and the options for that discussion mode will be activated:
  - **Open:** Participants can activate their microphone by pressing their microphone button. When the maximum number of speakers is reached, the next participant that presses their microphone button is added to a waiting list. The first participant in the 'waiting list' is allowed to speak when an activated microphone is disabled. The maximum number of open microphones is 25. The number of speakers/open microphones does not include the chairperson's microphone, because this microphone can always be activated.
 

**Auto shift:** When selected, queues in the waiting list are automatically shifted to the speaker list, if it is not full yet.
  - **Override:** Participants can override each other by pressing their microphone button. When the maximum number of speakers is reached, the next participant that presses their microphone button will deactivate the microphone that has been activated for the longest time. The chairperson's microphone is not included in the number of speakers/open microphones and, therefore, cannot be overridden by a participant.
  - **Voice:** Participants can activate their microphone by speaking into them. A microphone can be temporarily muted by pressing and holding down the microphone button.
  - **Push To Talk:** Participants can activate their microphone by pushing and holding in their microphone button. The microphone is deactivated when the microphone button is released. The maximum number of microphones that can be activated at the same time is determined by the maximum number of speakers in the speakers list.
- **Speakers options:**
  - **Maximum number of speakers:** Selects the maximum number of speakers in the speakers list.
  - **Switch microphone off when not used for 30 seconds:** This function can be used when participants forget to switch off the microphone manually.
  - **Allow participants to switch off their microphone:** When selected, participants are allowed to switch off their microphone.
  - **Show Possible To Speak:** When selected, the white symbol in the Wireless Device microphone request button is lit when the participant has the possibility to speak.





- **Waiting options:**
  - **Maximum number of waiting:** The maximum number of requests in the waiting list can be selected here. If you do not want to use the waiting list, set the **Maximum number of waiting** to zero.
  - **Allow participants to remove themselves from the waiting list:** When selected, participants can remove themselves from the waiting list.
  - **Show the first in the waiting list on the seat:** When selected, the LED on top of the Wireless Device microphone that is first in the waiting list will blink green instead of being steady green.
- **Priority options:**
  - **Priority chime audible:** When selected, a priority chime is audible when the device priority button is used.
  - **Mute all speakers:** When selected (grey), it mutes all speakers temporarily when the device priority button is used.
  - **Stop all speakers and remove all waiting participants:** When selected (grey), it cancels all speakers and requests when the device priority button is used.

## 5.3

### Voting

#### Preconditions:

The logged on user must have the access right: **Manage meeting**.



To manage voting, click the **Voting** button on the homepage. This opens the **Manage voting** page.

#### Manage voting means:

- Define the voting settings, and
- Control the voting round.

#### Define voting settings

- **Topic:** The name of the voting round. This name is also displayed on the touch screen of the Wireless Device Extended (DCNM-WDE) when the voting round is opened.
- Drop-down menu with answer sets for:
  - **for/against**
  - **for/against/abstain**
  - **for/against/abstain/dnpv**
  - **yes/no**
  - **yes/no/abstain**
  - **yes/no/abstain/dnpv**

The selected answer set is displayed on the touch screen of the Wireless Device Extended (DCNM-WDE) when the voting round is opened.



#### Notice!

DNPV (Do Not take Part in the Vote) can be selected by participants to indicate that they do not want to take part in the vote. This option is mostly used in France, where DNPV is abbreviated as NPPV.

- **Interim results:** the operator can configure which voting results are shown when the voting round is open:
  - **Totals and individuals:** when the voting round is open, the total results will be visible on the webpage, discussion devices with touch screen, the totals and individuals will be available via the API.
  - **Totals:** when the voting round is open, only the total results will be visible on the webpage, discussion devices with touch screen and API. When the voting round is on hold or closed, the total results will be visible on the webpage, discussion devices with touch screen, the totals and individuals will be available via the API.
  - **No interim:** when the voting round is open, no results will be visible on the webpage, discussion devices with touch screen and API. When the voting round is on hold or closed the total results will be visible on the webpage, discussion devices with touch screen, the totals and individuals will be available via the API.
- **100% setting:**
  - **Present button:** 100% = All participants that pressed the present button.
  - **Authorized for voting:** 100% = All participants in the system.
  - **Cast votes:** 100% = All participants that cast a vote.
- **Individual results:** you can enable or disable the availability of the individual results of a voting round. Disabling the individual results can be used to create a "secret ballot" or anonymous voting.

**Notice!**

A voting round can only have individual results when the votes are cast by participants.

---

**Control voting round**

- **Open** button: Opens the voting round. Once voting is opened, this button changes to the **Hold** button.
- **Hold** button: Puts the voting round on hold. The participants voting buttons are temporarily disabled and votes cannot be changed or cast. This button changes to the **Resume** button when it is pressed.
- **Resume** button: Allows voting to be resumed. Votes can be cast or changed again. This button changes to the **Hold** button when it is pressed.
- **Close** button: Closes the voting round.

## 5.4 System settings

### Preconditions:

- To access system settings and change parameters, the logged on user must have the access right: **Configure** or **Modify users**.



Click the **System settings** button on the homepage to open the **System settings** page:

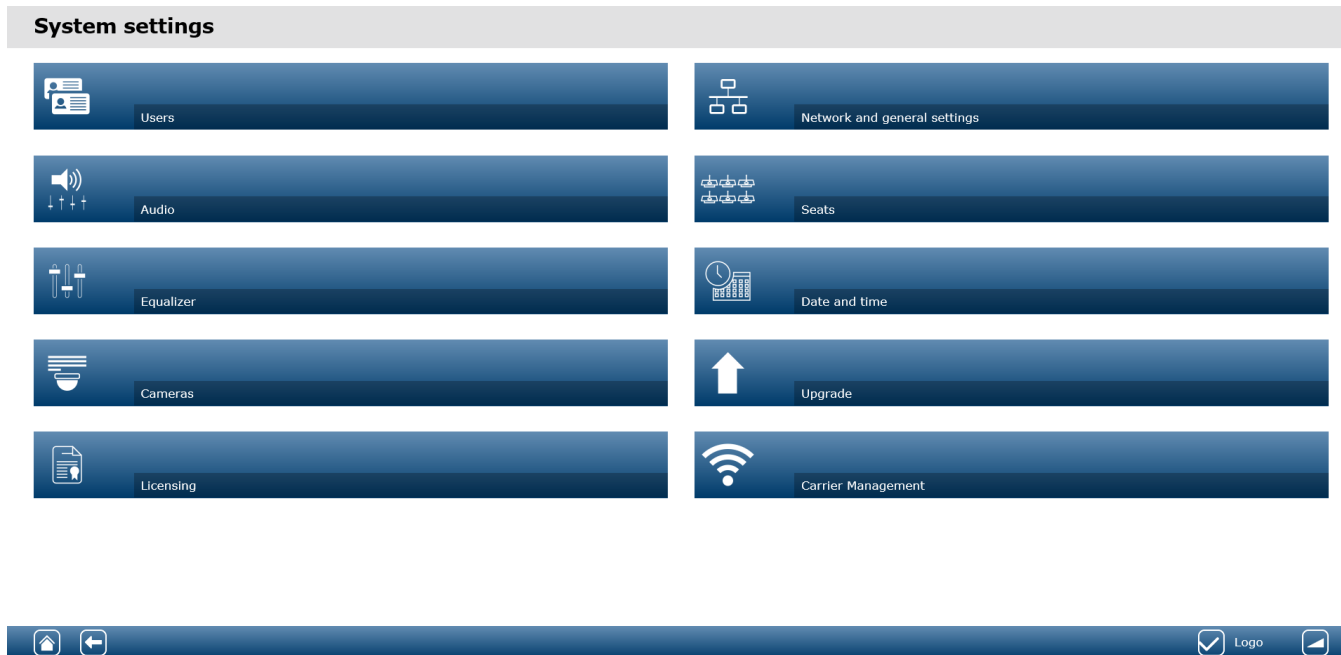

**Figure 5.2:** System settings page shown with access rights **Configure** and **Modify users**

- If the user only has the access right **Modify users**, only the **Users** button is shown.
- If the user only has the access right **Configure**, the **Users** button is not shown. All other buttons are shown instead.

### 5.4.1 Upgrade



#### Notice!

The software upgrade is not available for tablets.  
A tablet can also not be used to add software licenses to the system.



Click the **Upgrade** button to open the software **Upgrade** page.

The **Upgrade** page is used to:

- upgrade/maintain the software of the Wireless Access Point (DCNM-WAP) and Wireless Devices (DCNM-WD and DCNM-WDE).
  - upload the custom logo to the Wireless Device Extended (DCNM-WDE).
1. From the product related information page on <https://licensing.boschsecurity.com/software>, download the upgrade software file. Each device will have its own file:
    - Always start with upgrading the Wireless Devices.
    - Upgrade the DCNM-WAP last.
  2. From the **Upgrade** page, click in the **File:** box to select your saved software file.

3. The web browser interface application will automatically select the correct devices, depending on the selected file. If you do not want to upload firmware to a particular device, uncheck the checkbox for that device.
4. Click the **Start** button to start the upload process:
  - **Progress** bars are displayed indicating the upload process.
  - The upload status is shown in the **State** column (**Idle**, **Programming**, **Rebooting**, **Done** or **Failed** after reboot). If the upgraded file is corrupt or not recognized, an error message is displayed.
  - Software versions (numbers) are shown in the **Version** column. The uploaded software version number is only shown when the upgrade process is successful.
  - As soon as the DCNM-WAP is upgraded, it will reboot.

#### Software downgrade

- Downgrading the Wireless Devices will disconnect them from the Wireless Access Point, and the upgrade page cannot correctly indicate when the downgrade has finished.
- A WD(E) can be subscribed again when the yellow LEDs on the WD(E) are lit.
- If you need to downgrade the DCNM-WAP, make sure you de-initialize all Wireless Devices first.



#### Caution!

Optimal performance of the system can only be guaranteed if the DCNM-WAP and the Wireless Devices have the same software version. Take notice of this when upgrading or downgrading devices.

#### Upload custom logo

The custom logo can be uploaded to the Wireless Devices (DCNM-WDE) in the same way as upgrade software. The following conditions apply:

- The filename must start with DCNM-WDE.
- Only upload PNG files with dimensions of 480 x 272 pixels. Other file formats and dimensions are not supported.

#### Open Source Software licenses

To access the Open Source Software license terms go to:

For the DCNM-WAP:

- In the **System info** page, click on the licenses link at the bottom of the page to download the licenses file.

For all devices:

- In the **Upgrade** page, click the **Download** link in the **Licenses** column of the relevant device to download the licenses file.

## 5.4.2



### Users

Click the **Users** button on the system settings page to open the user settings page:

This page is used to enter and modify user information and rights.

- To add a user, click the **+** button to open the **Add new user** screen.
- To change a user's name, select the user (the dark grey color means selected), and then use the panel on the opposite side of the page to make changes.
- To change a user's password, select the user, and then click the **Change password** button.
- To change a user's rights, select the user, and then click the required **User rights** button.
- To remove a user, select the user, and then click the recycle bin.

For each (new) user, the following can be entered or selected:

- **General:** Enter **First name, Last name, Username, Password** (may be empty).
- **User rights:** Select the required user rights for the user (grey means selected):
  - **Manage meeting.** This right gives access to the **Manage discussion** and **Voting** pages, and volume control. Refer to *Manage discussion, page 15* or *Voting, page 18*.
  - **Prepare meeting.** This right gives access to the **Prepare discussion** and **Participants** pages. Refer to *Prepare discussion, page 16*.
  - **Modify users.** This right gives access to the page. Refer to *Users, page 22*.
  - **Configure.** This right gives access to the **System settings** page (excluding the **Users** page, unless the user has the right **Modify users**), the **System info, Logging,** and **Battery and signal** pages, and volume control. Refer to *System settings, page 20*.
  - **Prepare system.** This right gives access to the **Power** and **Battery and signal** pages. Refer to *Power, page 33*.

## 5.4.3



### Audio

Click the **Audio** button to open the **Audio settings** page:

- **System:**
  - **Master:** Master volume control for the loudspeakers of the Wireless Devices, and the line output of the Wireless Access Point.
- **Line input/output:**
  - **In:** Sets the sensitivity of the audio line input of the Wireless Access Point.
  - **Out:** Sets the level of the audio line output of the Wireless Access Point.
- **Routing options:** Defines the audio routing mode of the Wireless Access Point:
  - **Recorder:** Use this mode to connect an external recorder via the audio line output.
  - **Floor:** In this mode, the level of the audio line output is “also” controlled by the **Master**.
  - **Mix-minus:** Use this mode to connect an external telephone coupler, or two systems, via the audio line input and audio line output.
  - **Insertion:** Use this mode to connect external audio devices, such as audio mixers, and audio processors.
  - **PA (Public Address):** In this mode, the level of the audio line output is “not” controlled by the **Master**.
- **Digital Acoustic Feedback Suppression:** Settings for the DAFS function:
  - **Off :** Sets the DAFS function to off.
  - **Natural:** Sets the DAFS function to on and selects the natural algorithm for speech.

- **Maximum:** Sets the DAFS function to on and selects the maximum algorithm for speech, which reduces the risk of acoustic feedback (howling) at higher system volume levels.  
**Note:** Audio artifacts might occur at higher volume levels.
- **Feedback prevention:**
  - **Loudspeaker active when microphone is on:** The participant's loudspeaker is active when their microphone is on.
  - **Attenuate headphone when speaking:** Attenuates the headphone volume of the Wireless Devices with 18 dB when selected and the microphone is on.
- **Test tone:** Click the appropriate button to test the audio in the system with a **1 KHz** or **Sweep** tone. Click the **Off** button to stop the test tone.
  - When **Send test tone to loudspeakers** is selected, generates the selected test tone to the connected Wireless Devices loudspeaker.
  - When **Send test tone to headphones** is selected, generates the selected test tone to the connected Wireless Devices headphone.
  - When **Send test tone to line output** is selected, generates the selected test tone to the audio line output of the Wireless Access Point.

#### 5.4.4



### Equalizer

Click the **Equalizer** button to open the **Equalizer settings** page:

The **Equalizer settings** page is used to set the equalizer settings of the audio line input and output of the Wireless Access Point and Wireless Devices loudspeaker.

#### Equalizer filters

- **Filter 1** type: Shelving filter - A shelving filter for low frequencies with a fixed quality factor.
- **Filter 2, 3, 4** type: Full parametric section - Three full parametric filters with adjustable quality factors, gains and frequencies.
- **Filter 5** type: Shelving filter - A shelving filter for high frequencies with a fixed quality factor.

#### Equalizer settings

Proceed as follows to configure a filter:

1. Enter the frequency of the filter. Possible values from 50 Hz up to 22 kHz.
2. Enter the gain of the filter. Possible values from -12 dB to +12 dB with steps of 0.1.
3. Enter the quality (Q) factor of the filter. Possible values from 0.4 to 14 with steps of 0.1.
4. Enable or bypass the filter by clicking the checkmark. All changes are immediately applied.

#### 5.4.5



### Cameras

Click the **Cameras** button to open the **Camera settings** page:

- **Overview camera:** Defines the camera used as the overview camera.
- **Pre-position:** Defines the preposition of the camera used for the overview.  
**Note:** Only available when a PTZ/Dome camera has been selected as an overview camera (if a fixed camera or **None** is selected, this field is not visible). A total of 6 cameras can be connected. The following HD-SDI switchers are supported:
  - TVOne CORIOmatrix mini.
  - Kramer MV-6.
- **SDI Switcher:** Enter the IP address of the HD-SDI video switcher used. Do not use leading zeros. If leading zeros are entered, the DCNM-WAP will not be able to control the switcher.

- **Example:**
  - Correct IP address: 192.168.10.111
  - Incorrect IP address: 192.168.010.111
- Overview list: Here all connected cameras are listed. The overview list shows: the **Camera name, URL, Serial number, Username, Password, Protocol**, and to which video switcher **Input** the camera is connected to.
  - The camera **Serial number** is used as a link to the camera configuration web pages.  
**Note:** Only possible if your PC/laptop or tablet device is connected via the wired Ethernet connection of the system.

**Notice!**

Ensure that the Bosch ONVIF Camera has firmware 5.80 or higher.

**ONVIF cameras**

ONVIF cameras are automatically detected, but you still need to:

1. Enter a username and password if the camera has a username and password configured.
2. Select the switcher input the camera is connected to.

**Panasonic and Sony cameras**

The system supports Sony IP cameras via CGI commands for 300/360 series, and Panasonic IP cameras via CGI protocol (HD Integrated Camera Interface Specifications 1.06).

Panasonic and Sony cameras are not automatically detected. You need to:

1. Manually add the camera using the + button.
2. Enter the camera URL (as http:// for a non-secure connection or https:// for a secure connection).
3. Enter the username and password for the camera.
4. In the **Protocol** field, select Sony for Sony cameras, and Panasonic for Panasonic cameras.
5. Select the switcher input the camera is connected to.

Until the camera is properly connected, a trash can is displayed next to the **Camera name** allowing you to delete the camera.

Once the camera is connected (the **URL, Username, Password** and **Protocol** fields are all correct) you can browse to a specific camera using the link in the **Serial number**.

**Note:** Only a disconnected camera can be removed.

**Notice!**

You can use the **Camera name** to assign a logical name to the camera, e.g. right rear camera.

**5.4.6****Licensing**

Click the **Licensing** button to open the **Licensing** page.

Licensing is only required when you purchase software licenses.

The **Licensing** page provides you with an overview of the activated licenses.



**Activate a license:**

To activate software you need to have an activation ID which was send by email after purchasing the software license. Activation requires a USB memory stick and any PC connected to the internet.

**Note:** License activation is not supported for tablets.

1. Insert the USB memory stick into the PC connected to the Wireless Access Point (DCNM-WAP).
2. Click the **Add license** button.
3. Enter all required **Customer information** and **Activation ID**, click the **Add license** button and then the **Activate** button. **Note:** You can add more than one **Activation ID**. When all activation IDs are added, click the **Activate** button.
  - A “save as” dialog is shown. Save the “request file” to your USB memory stick.
4. Go to the website <https://licensing.boschsecurity.com> using a PC/Laptop which is connected to the internet, and login. If you do not have a username, contact your local Bosch representative to acquire an account:
  - Go to “manage license” and upload the “request file” from the USB memory stick.
  - Save the “response file” to your USB memory stick.
5. In the DICENTIS web browser interface application, click the **Process response message** button. Select the correct response file from the USB memory stick, and then click “Open”.
  - Now the license is activated.
  - New functionality is added and can be used by the system.

**Returning a license**

The return license process is started in the license website.

1. Log on to <https://licensing.boschsecurity.com>
2. Go to the overview, and find the customer that the license must be returned to.
3. Click on the link in the “location” column to open the “system details” pop-up.
4. Click the “return license” button.
  - A file will be generated. Save it to a USB memory stick.
5. Go to the license page of the web browser interface application.
6. Click the **Process response message** button.
  - Select the correct file from the USB memory stick, and then click “open”.
  - A save as dialog is shown. Save the file to your USB memory stick.
7. Return to the license website, go to “manage license”, and upload the “request file” from the USB memory stick.
  - Now the license is returned.

**5.4.7****Network and general settings**

Click the **Network and general settings** button to open the network and general settings page. Here the network and general settings are displayed and can be set:

Click the **Change network settings** button to enter/change the network settings:

- **Network settings:**
  - **Hostname:** Enter the network name of the DCNM-WAP. The default name is **dcnm-wap**.
- **Wifi**
  - **Network name (SSID):** **Bosch DICENTIS** (factory default).
  - **WPA2 Key** (password): **dcnm-wap** (factory default).

- **Channel:** Shows the currently selected WiFi channel. The channels are selected in the **Carrier Management** page. See *Carrier Management*, page 29.
- **Wired:**
  - **Fixed IP:** Select this checkbox if you want to use a fixed IP address. The fields below change from grey to white to indicate that they are activated.
  - **IP Address:** Enter a valid IP address.
  - **Subnet mask:** Enter a valid subnet mask.
  - **Default gateway:** Enter a valid default gateway.
- **WAP redundancy:** Use these settings to configure the WAP as a standalone, primary or secondary Wireless Access Point. The **Primary** and **Secondary** buttons are used to set up a redundant system.
  - **Standalone**(factory default setting): The connected WAP functions as a single Wireless Access Point. No redundant WAP is configured.
  - **Primary:** Selects the connected WAP as the primary Wireless Access Point. To do this, select **Primary**. As soon as the WAP is set to primary, the **Subscription mode** check box is enabled. This check box is used to enable subscription of a secondary WAP.
  - **Secondary:** Selects the connected WAP as the secondary Wireless Access Point. To do this, select **Secondary**. As soon as the WAP is set to secondary, the **Subscribe** button is enabled after login. This button is used to subscribe the secondary WAP to the primary WAP.
  - **Subscription mode** check box: Use this checkbox on the primary WAP in combination with the **Subscribe** button on the secondary WAP to subscribe a secondary WAP to the primary WAP. If the **Subscribe** button is not selected within two minutes, the check mark will disappear and will have to be selected again.
  - **Subscribe:** Use this button on the secondary WAP in combination with the subscription mode on the primary WAP to subscribe the WAP as the secondary Wireless Access Point. The configured and operation status of the WAPs is displayed below the **Subscribe** button.

### Setting up a redundant WAP

This procedure describes how to set up a redundant WAP for wireless operation/redundancy.

#### Preconditions

- Preferably both WAPs are connected to an Ethernet network switch with a DCN multimedia System Network Cable or a standard network cable, and the Ethernet network switch is connected to a laptop or PC.
 

**Note:** The use of an Ethernet network switch and cabling are preferred during the subscription process, because this makes it easier to access and subscribe the WAPs. When subscription of the secondary WAP is complete, the Ethernet network switch and cabling can be removed if it is no longer required.
- The WAPs are correctly positioned (there should be a minimum distance of one meter and a maximum distance of three meters between the two WAPs).
- The WAPs are powered up and the Wireless Conference System is operational.
- Both WAPs have been correctly configured in the Installation Wizard and have unique names for:
  - Network name (SSID)
  - WPA2 key
  - Hostname
- Both WAPs are set to the **Standalone** (factory default).

- The applicable licenses are available for the primary WAP and the secondary WAP (the redundant WAP requires its own set of licenses for features such as voting and dual-use at seat to continue working if the primary WAP fails).
- If recording/playback and PA are required, make sure audio connectors are connected to the balanced In/Out connectors of both the primary and secondary WAP.
- If access to the API (for showing voting results) and web browser settings is required, make sure Ethernet cables are connected to both the primary and secondary WAP.

#### Procedure

1. For ease of configuration, open two web browser windows side by side on your laptop or PC.
2. In the right-hand browser window, log into the secondary WAP, and then select **System settings > Network and general settings**.
3. In the left-hand browser window, log into the primary WAP, and then select **System settings > Network and general settings**.
4. Select **Primary**.
  - A warning is displayed that the new setting cannot be undone unless you perform a factory reset.
5. Select **Continue**.
  - The **Primary** button is shaded dark gray to indicate that the WAP is set as the primary WAP. The hostname of the primary WAP will change to: hostname-**redundant**.
  - The **Standalone** and **Secondary** buttons are grayed out to indicate that they cannot be selected anymore.
  - The **Subscription mode** check box is enabled for subscribing the secondary WAP.
6. In the right-hand browser window, select **Secondary**.
  - A warning is displayed that the new setting cannot be undone unless you perform a factory reset.
7. Select **Continue**.
  - The connection with the WAP will be broken, and you will be logged out.
8. Log in to the secondary WAP, and then select **System settings > Network and general settings**.
  - Only a limited number of options are displayed, because this WAP is being set as the secondary WAP. All options will be available in the secondary WAP if the primary WAP is switched off or fails.
  - The **Secondary** button is shaded dark gray to indicate that the WAP is set as the secondary WAP.
  - The **Standalone** and **Primary** buttons are grayed out.
9. In the left-hand browser window, select the **Subscription mode** check box, so that a WAP can be subscribed to the primary WAP.
10. In the right-hand browser window, select **Subscribe**.
  - The secondary WAP searches for and subscribes to the primary WAP. This can take some time depending on the network.
11. For the **Primary** WAP (left-hand browser window) , make sure the following messages are displayed below the **Subscribe** button
  - **Configured: Primary** and **Secondary**.
  - **Operational: Primary** and **Secondary** connected.
12. For the **Secondary** WAP (right-hand browser window), make sure the following messages are displayed below the **Subscribe** button:
  - **Configured: Secondary** and **Primary**.

- **Operational: Secondary** and **Primary** connected.
13. Make sure a yellow triangle is not displayed in the bar at the bottom of the page. This triangle indicates that the connection to the WAP is either incorrect or has been lost. If this triangle is displayed, refer to the messages below the **Subscribe** button for each WAP to determine the status of the system.
  14. The redundant WAP is now ready for use.



#### Notice!

After booting the redundant system, check if the system is running in redundant mode. To do this, check the LEDs on the WAP, and/or check the status of the WAP in the browser.

- **General settings:**
  - **DCNM-WDE GUI language:** Select the GUI language for the Wireless Device Extended (DCNM-WDE) touch screen.
  - **Factory default** button: Click this button to reset the Wireless Access Point to the factory default. After a factory default, all settings are returned to their default value, and all Wireless Devices need to be subscribed.  
**Important:** Before you activate the factory default, make sure all Wireless Devices are switched on and in range of the DCNM-WAP. If Wireless Devices are not de-initialized during a factory default, they must be de-initialized manually before they can be subscribed again.



#### Notice!

When the system is reset to the factory defaults, the latest version of the software that the system was upgraded to, and the installed licenses, will be maintained.

## 5.4.8



### Seats

Click the **Seats** button to open the **Seat settings** page.

Here the Wireless Devices can be assigned to seats:

- Seats overview:
  - **Select:** The header of this column shows the number of known seats and the number of connected seats. If a seat is disconnected, the “disconnect” symbol is displayed to the left of the seat row.
  - **Seat name:** Change the seat name.
  - **Prio:** When selected, the participant is able to use the Wireless Device “priority” (chairperson) button.
  - **Dual:** When selected, the Wireless Device is configured for dual-use (requires seat software license: DCNM-LSDU).  
**Note:** A device cannot be prio and dual simultaneously, so when **Prio** is selected, the dual checkbox is disabled.  
**Note:** When a device is set to dual-use and the voting or identification feature is enabled for one seat, the other seat will then automatically have the voting or identification feature enabled as well. This means that 2 voting and/or identification licenses will be required in this case.
  - **ID:** When selected, the identification feature is enabled. Participants can use an NFC tag to identify themselves at the Wireless Device Extended (requires seat software license: DCNM-LSID).

- **Voting:** When selected, the voting feature is enabled. Participants can cast their vote at the Wireless Device Extended (requires seat software license: DCNM-LSVT).
- **Camera:** The camera name connected to the seat (requires system software license: DCNM-LCC).
- **Pre-position:** Camera preposition setting number assigned to the seat (requires system software license: DCNM-LCC).
- **Selection mode:** When selected, a Wireless Device can be located by clicking the **Select** symbol to the left of the seat row. The red microphone LED on the selected Wireless Device will illuminate to indicate its position in the conference room.
- **Subscription mode:** When selected, a Wireless Device not associated with a DCNM-WAP, can be associated with this DCNM-WAP by pressing the request button on the Wireless Device. A new seat will be assigned to this device and added to the seats overview. Refer to *Wireless Device initialization, page 10*.
- **De-init** button: When clicked, it erases the subscription of all Wireless Devices. All LEDs on the Wireless Device are on when the Wireless Device does not have a subscription.
- **Remove disconnected seats** button: Removes all seats which are currently not connected to the system.

### 5.4.9



#### Date and time

1. Click the **Date and time** button to open the **Date and time settings** page:
2. Click the **Change date and time settings** button to select:
  - **Date:** Select the current date.
  - **Time:** Select the local time.
  - **Time zone:** Select the local time zone from the list.
3. After changing these settings, the WAP will automatically reboot. Wait until the system has completed the reboot cycle.

#### Notice!



The DCNM-WAP can automatically synchronize the date and time with a internet time server. If the internet is not available, the DCNM-WAP tries to synchronize with a time server which is offered by the DHCP server. If the time server can not be reached, the date and time can be set manually. If a time server becomes available the DCNM-WAP will synchronize the date and time.

### 5.4.10



#### Carrier Management

Click the **Carrier Management** button to open the **Carrier Management** page.

Use this page to set the wireless channels that can be used for your Wireless Conference System. These predefined channels are automatically selected by the setup Wizard during installation of the system software after selecting the Country of choice. The available channels are displayed on the **Carrier Management** page.

During operation, the Wireless Conference System can automatically switch between selected channels to ensure uninterrupted operation of the system.

- **2.4 G (channels 1 through 11):** Available non-DFS channels in the 2.4 G frequency range.
- **5 G-U11-1 (channels 36 through 48):** Available non-DFS channels in the 5 G-U11-1 frequency range.
- **5 G-U11-3 (channels 149 through 165):** Available non-DFS channels in the 5 G-U11-3 frequency range.

- **5 G-U11-2 (channels 52 through 64):** Available DFS channels in the 5 G-U11-2 frequency range.
- **5 G-U11-2e (channels 100 through 140):** Available DFS channels in the 5 G-U11-2e frequency range.

**Notice!**

When the system is using a DFS channel it continuously checks for the presence of radar. If radar is detected, the system automatically switches to the best available non-DFS channel.

**Selecting wireless channels**

- To ensure reliable system operation, select as many channels as possible so that the system has sufficient channels to switch between.
- Select at least one non-DFS channel. To make sure the system works correctly, use as many channels as possible.
- Bosch recommends to select at least two non-DFS and one or more DFS channels, so that the system has sufficient freedom to switch between channels.
- Channels in the 5 G-U11-1 and 5 G-U11-3 frequency ranges are preferred, because these channels are non-DFS and non-overlapping wireless channels. Since the 2.4 GHz frequency range is generally congested, try to avoid the usage of this band.
- If your organization has restrictions on the use of WIFI equipment, contact your IT department to decide which channels to use for your Wireless Conference System.

## 5.5 Participants

### Preconditions:

- The logged on user must have the access right: **Prepare meeting**.
- The seat software license DCNM-LSID is required.



Click the **Participants** button on the homepage to open the **Participants** and **Identification** settings page.

Participants can be assigned seats and/or an NFC tag can be configured to identify participants to the system. When a participant is identified by the system, the name of the participant is shown in the speaker list and waiting list.

**Note:** This page has a feature for automatically assigning NFC tag IDs to participants.

The following items can be set on this page:

### Identification

- **off** (grey):
  - Participant names are not used and are not shown in the speaker list and waiting list.
  - Participants cannot use an NFC tag to identify themselves.
  - No individual voting results are available and the setting for individual results cannot be selected.
- **by assignment** (grey):
  - Seats must be assigned to participants. If a seat is not assigned to a participant, that seat cannot be used.
  - Participants cannot use an NFC tag to identify themselves.
  - A seat can be used without having to identify the participant.
- **at assigned seat** (grey):
  - Seats must be assigned to participants. If a seat is not assigned to a participant, that seat cannot be used.
  - Participants must use an NFC tag to identify themselves at the assigned seat.
  - If a participant tries to identify him/herself at another seat, a message is displayed on the Wireless Device to inform the participant that they are at the incorrect seat.
  - The seat cannot be used until the assigned participant is identified at the seat.
 

**Note:** The seat must have the ID checkbox enabled on the **System settings > Seats** page.
- **at any seat** (grey):
  - Participants can use an NFC tag at any seat to identify themselves.
  - The seat cannot be used, until a participant has been identified at that seat.

### Reader:

- The **Reader** drop-down list is used in combination with the **Assign** button to assign NFC tags to participants.
- **None:** The reader function is disabled.
- **Seat** name: The reader function is enabled:
  - Click a **Seat** name from the **Reader** drop-down list to configure the corresponding Wireless Device as an NFC card reader. The Wireless Device indicates that the NFC tag should be held near the left side of the Wireless Device.
 

**Note:** The Wireless Device cannot be used to participate in a meeting as long as it is configured as an NFC-card reader.
  - Hold an NFC tag close to the left side of the Wireless Device. The **NFC-ID** will appear on the screen of the Wireless Device and next to the **Assign** button.

- In the participants overview (see heading below), select a row that you want to assign the **NFC-ID** to. The entire row is highlighted in dark grey.
- Click the **Assign** button to assign the NFC-ID to the participant.

**Assign** button:

- The **Assign** button is used in combination with the **Reader** drop-down list to assign NFC tags to participants.

**Participants overview**

- **Name:** The participants (editable) name.
- **NFC-ID:** The number of the Near Field Communication (NFC) tag for the participant.
  - If an NFC card reader is used in combination with the **Assign** button to enter the NFC-ID, this field is updated automatically.
  - If a card reader is not used, the NFC-ID can be entered manually. If the incorrect format is entered for the NFC-ID, a thin red border is displayed around the **NFC-ID** field.
- **Seat:** Selects the seat name, from the list, that the participant is assigned to.
- **Trash can:** Removes the selected participant.

If identification is used, and a participant is in the waiting list, the participant can log out of the system and still maintain their position in the waiting list. This type of request-to-speak is referred to as a flying request.

- If the option 'at any seat' is enabled on the 'Participants' page, the participant has the freedom to log in at any device and rejoin the meeting.
- If the participant does not rejoin the meeting, and their turn to speak has passed, the participant will be automatically removed from the waiting list.

This also means that a waiting list can be created without participants being seated at a particular device.

**Example:** A participant makes a request to speak: The participant's position in the waiting list is tenth, so the participant decides to briefly leave the meeting. On returning, the participant sees that their position in the waiting list is now second (about to speak), so the participant quickly logs in to the nearest available device.



## 5.6 Power

### Preconditions:

- The logged on user must have the access right: **Prepare system**.



Click the **Power** button on the homepage to display the power pop-up window:

- **On:** Activates the DCNM-WAP. The Wireless Devices have to be switched on manually. See *Power up* in the *User manual*.
- **Standby:** Switches off the subscribed devices and sets the DCNM-WAP to Standby. The web browser interface of the DCNM-WAP can still be accessed. Switching from **Standby** to **On** automatically re-enables the Wireless Devices (use this option when you want to pause the meeting).
- **Off:** Switches off the subscribed devices. The web browser interface of the DCNM-WAP can still be accessed, but the DCNM-WAP stops transmitting (use this option when you want to end the meeting).
- **Cancel:** Cancels the **Power** pop-up window.

## 5.7 Battery & Signal

### Preconditions:

- The logged on user must have the access right: **Configure** or **Prepare system**.



Click the **Battery & Signal** button on the homepage to open the **Battery and Signal** overview page.

The following information is shown for each seat that is currently connected to the Wireless Access Point:

**Note:** If a seat is disconnected, the “disconnect” symbol is displayed to the left of the seat row, and the data in the seat row is not displayed.

- **Seat:** The seat name.
- **Battery:** Indicates the remaining power supply capacity, in hours, of the Battery Pack of the Wireless Device.
 

**Note:** After replacing a battery or powering up a Wireless Device, the number of battery hours displayed might be higher than the actual life of the battery. This value will stabilize after a short while.
- **Charges:** Shows the number of times the Battery Pack battery is charged.
- **Signal:** Indicates the WiFi signal strength as a colored bar graph.
- **Test:** This column shows the result of the range test.
- **Start range test** button (bottom of page): Press this button to start the range test. The system DCNM-WAP starts to measure if all Wireless Devices are in range of several frequencies. This guarantees that the Wireless Devices will continue to work if the DCNM-WAP decides to switch to another WiFi channel in case of interference.
 

**Note:** The **Test** column and the **Start range test** button are only displayed when the logged in user has the user right **Configure**.
- **Serial number:** The serial number of the Battery Pack.

## 5.8 Logging

### Preconditions:

- The logged on user must have the access right: **Configure**.



Click the **Logging** button on the homepage to open the **Logging** page.

- Click the **Clear view** button to clear all events from the view. After reopening or refreshing the **Logging** page, all events are visible again.
- Click the **Export** button to open a pop-up window for saving the current event logging overview file (logging.txt format).



### Notice!

Logging export is not available for tablets.

## 5.9 System info

### Preconditions:

- The logged on user must have the access right: **Configure**.



**System info** is used by a technician. Click the **System info** button on the homepage to open the **System info** page. The following information is displayed:

- Device Type
- Hostname
- Ethernet MAC address
- Ethernet IP address
- Ethernet subnet mask
- Ethernet default gateway
- Wireless IP address
- Version
- API
- Country
- Link to download the Open Source Software license terms

## 5.10 Logout

### Preconditions:

- None



Click the **Logout** button to log out, which returns you to the **Login** page.

## 6 Wireless Access Point LED behavior

The LEDs on the front panel of the Wireless Access Point (DCNM-WAP) give information on the (configuration) status of the Wireless Access Point.

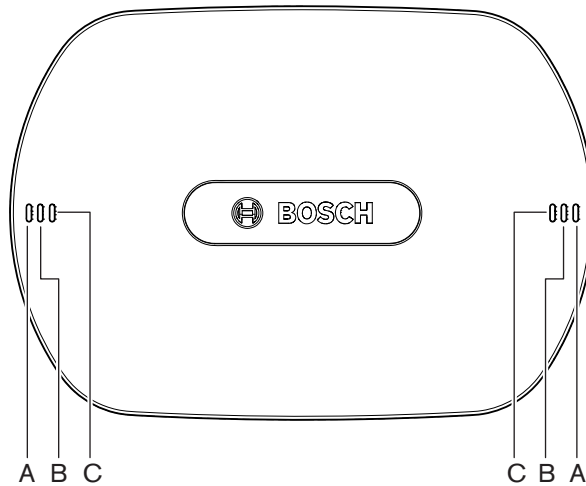

Figure 6.1: DCM-WAP status LEDs

Blue (A)	Red (B)	Blue (C)	Description
Flashing	Off	Off	<ul style="list-style-type: none"> <li>No Wireless Device connected yet.</li> <li>Subscription mode is off.</li> </ul>
On	Off	Off	<ul style="list-style-type: none"> <li>At least one Wireless Device is connected.</li> <li>Subscription mode is off.</li> </ul>
Flashing	Flashing	Flashing	<ul style="list-style-type: none"> <li>The DCM-WAP is starting-up.</li> </ul>
On	Flashing	Off	<ul style="list-style-type: none"> <li>Software upgrade of the DCM-WAP is active.</li> </ul>
On	Flashing	On	<ul style="list-style-type: none"> <li>Software upgrade of the Wireless Device is active.</li> </ul>
Flashing	Off	On	<ul style="list-style-type: none"> <li>Subscription mode is on.</li> <li>No Wireless Device connected yet.</li> </ul>
On	Off	On	<ul style="list-style-type: none"> <li>Subscription mode is on.</li> <li>At least one Wireless Device is connected.</li> </ul>
Off	Flashing	Off	<ul style="list-style-type: none"> <li>System is in Standby mode.</li> </ul>
Off	Off	Off	<ul style="list-style-type: none"> <li>No DC power supply connected.</li> </ul>
Off	Off	On	<ul style="list-style-type: none"> <li>Secondary DCM-WAP connected to primary DCM-WAP.</li> </ul>
Off	On	On	<ul style="list-style-type: none"> <li>Secondary DCM-WAP disconnected from primary DCM-WAP.</li> </ul>

Blue (A)	Red (B)	Blue (C)	Description
			– System scanning for primary DCNM-WAP.

**Table 6.1:** Status LEDs

# 7 Troubleshooting

## 7.1 Customer service

If a fault cannot be resolved, please contact your supplier or system integrator, or go directly to your Bosch representative.

## 7.2 Troubleshooting table

Problem	Possible cause	Possible solution
The software upgrade fails	The batteries in the Wireless Devices are insufficiently charged.	Check the battery charge on the <b>Battery and signal</b> page, and charge the batteries accordingly.
	The WAP is switched off.	Make sure the WAP is switched on.
	The Wireless Devices are switched off or not subscribed to the WAP.	Make sure the Wireless Devices are switched on and subscribed to the WAP.
	The Wireless Devices are not within range of the WAP.	Use the range test on the <b>Battery and signal</b> page to determine if the Wireless Devices are within range of the WAP.
	The wireless network is overloaded.	Connect the WAP(s) to a laptop or PC with a DCN multimedia System Network Cable or a standard network cable. <b>Note:</b> If a redundant WAP is configured, an Ethernet network switch is required to connect the two WAPs to the laptop or PC.
The redundant WAP does not work.	The primary WAP and secondary WAP are incorrectly positioned.	Make sure there is a minimum distance of one meter and a maximum distance of three meters between the two WAPs.
I cannot log in to the secondary WAP when the system switches to redundant mode.	The web browser cache contains information from the primary WAP.	Delete the web browser cache.
The web browser interface does not connect with the Wireless Access Point	– On a Windows PC/ laptop, Bosch DNS SD is not installed.	Install Bosch DNS SD or Apple Bonjour.

Problem	Possible cause	Possible solution
(DCNM-WAP), or there are problems logging in to the system.	– On any other device, Apple Bonjour is not installed.	
	The web browser cache contains out-dated information from a previous software version.	Delete the web browser cache.
The country cannot be changed.	This can only be done if the system is set to the factory default.	Set the system to the factory default. <b>Note:</b> Setting the system to the factory default will not downgrade the software; the latest version of the software that the system was upgraded to will be maintained. The currently installed licenses will also be unaffected.
System performance is not optimal.	The DCNM-WAP and the Wireless Devices do not have the same software version.	Upgrade the software.
The external SDI video switcher does not switch between inputs.	Switcher has incorrect settings.	Reset the switcher to factory defaults. Then set the TCP connection port number. – For the Kramer MV-6 switcher, set the TCP connection port number to 5000. – For the tvOne CORIOmatrix switcher, set the TCP connection port number to 10001.
After changing the DCNM-WAP hostname, the DCNM-WAP cannot be accessed with the new name.	The new hostname is not recognized by the system software.	Restart the system.
The TV-One CORIOmatrix mini does not react to switching commands from the DCNM-WAP when the webpage of the TV-One Corio is used.		Logout from the TV-One CORIOmatrix mini webpage.

Problem	Possible cause	Possible solution
The Range Test might cause the web browser application to disconnect when it is connected wirelessly to the DCNM-WAP.		Start the Range Test from a web browser application that is connected to the DCNM-WAP with a cable.
When changing the hostname or (de)activating the fixed IP address in the web browser interface, the laptop/PC loses the connection with the DCNM-WAP.		<ul style="list-style-type: none"> <li>– Close and then re-open the web browser interface.</li> <li>– Use the new hostname or IP address to access the DCNM-WAP.</li> </ul>
The blue power led on the DCNM-WCH05 is flashing indicating a fault state.	Voltage or current fault to one of the chargers.	<ul style="list-style-type: none"> <li>– Restart the charger.</li> </ul>
In the web browser, the range test results in a red cross on one of the channels. After the test, the signal is good again on this channel.	On one of the channels there may be a range problem during the test. After the test the system will move to the best available channel again.	<ul style="list-style-type: none"> <li>– Ignore red-cross in range test if just one of the channels fails but recovers afterwards.</li> </ul>
Audio disturbance in wireless system.	PC running Windows 10 is subscribed to the audio Wi-Fi network.	<ul style="list-style-type: none"> <li>– Remove the audio Wi-Fi network subscription for this PC.</li> </ul>
Battery will not charge, or charging takes longer than expected.	Battery is in deep discharge mode because it has not been used or charged for some time.	<ul style="list-style-type: none"> <li>– Leave the battery in the charging bay for 2 hours. If the battery still does not charge (time out mode), remove it from the charging bay. The battery may be faulty and should be replaced.</li> </ul>











**Bosch Security Systems B.V.**

Torenallee 49

5617 BA Eindhoven

Netherlands

**[www.boschsecurity.com](http://www.boschsecurity.com)**

© Bosch Security Systems B.V., 2023

**Building solutions for a better life.**

202312181134