

B
NKI-9000-F19QS1

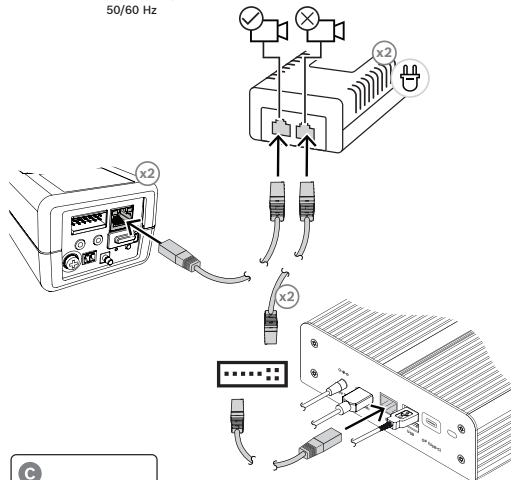

C
NKI-9000-F19QS2

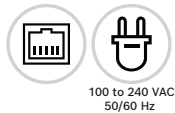
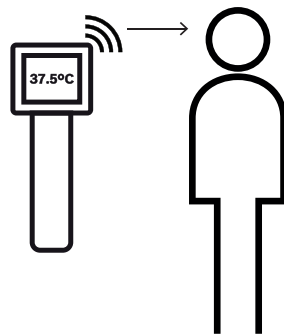
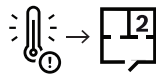
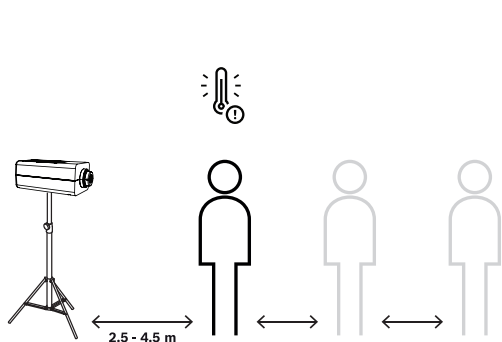
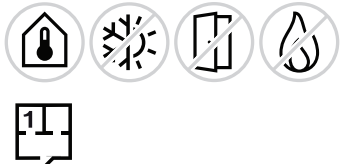
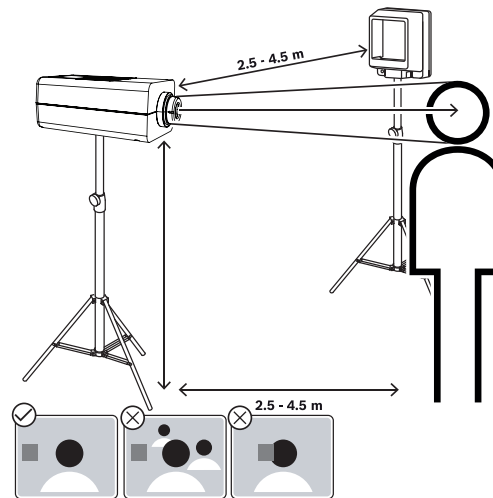

1. Do not rely on the measurement, solely or primarily, to diagnose or exclude a diagnosis of COVID-19 or any other disease.
2. Confirm an elevated body temperature, in the context of use, with secondary evaluation methods such as using a non-contact infrared thermometer (NCIT) or a clinical grade contact thermometer.

Human skin temperature detection solution

NKI-9000-F19QSC | NKI-9000-F19QS1 |
NKI-9000-F19QS2

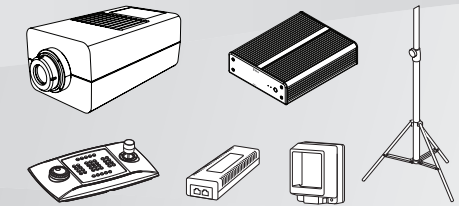

en Quick installation guide

Bosch Security Systems B.V.
Torenallee 49
5617 BA Eindhoven
The Netherlands
www.boschsecurity.com
© Bosch Security Systems B.V., 2020