



Fire Alarm Control Panels

FPD-7024 Family



BOSCH

en Installation and operation guide

Table of contents

1	Notices	6
1.1	Open Source Software Information	6
1.1.1	License texts	7
1.2	FCC Compliance Notice	14
1.3	FCC Phone Connection to Users	14
1.4	Industry Canada Notice	15
1.5	NFPA Standard 72	15
1.6	Trademarks	16
2	Fire Safety	17
2.1	Having and practicing an escape plan	17
3	Overview	18
3.1	System overview	18
3.2	Components	19
3.2.1	On-board conventional points	19
3.2.2	Off-board addressable points	19
3.2.3	Enclosure Housing	20
3.2.4	Remote LCD Keypads	20
3.2.5	Remote LED Annunciators	20
3.2.6	D7032 - use with the D7030X	20
3.2.7	Communicator	22
3.2.8	Users	23
3.2.9	Lightning protection	23
3.2.10	Battery backup calculation	23
3.2.11	Required batteries for existing load	26
3.2.12	Compatible devices	27
4	Installation	30
4.1	UL Listed systems installation guide	30
4.1.1	FPD-7024 UL Listings	30
4.1.2	Installation considerations	30
4.1.3	UL requirements	30
4.2	Installing the enclosure	31
4.3	Installing the FACP	33
4.4	Installing optional equipment	33
4.5	Installing detection devices	34
5	Connection	36
5.1	FACP terminal connection	36
5.2	Option bus wiring requirements	43
5.3	Power supply connection	44
6	System operation	46
6.1	Modes of Operation	46
6.1.1	Normal	46
6.1.2	Off-normal Displays	46
6.1.3	Acknowledge	46
6.1.4	Alarm	46
6.1.5	Supervisory	46
6.1.6	Trouble	47
6.1.7	Fire Silence/Reset	47
6.2	Basic System Use	48

6.2.1	Function keys	48
6.2.2	Selecting menu items	48
6.2.3	After Main Menu item selected	48
6.2.4	Returning to an earlier screen	48
6.2.5	Entering data	48
6.2.6	Drill	48
6.2.7	Disable	48
6.2.8	History	49
6.2.9	Remote Programming	50
6.3	Keypads	50
6.3.1	Built-in keypad	50
6.3.2	FMR-7033 keypad	51
6.3.3	FMR-7036 Annunciator Keypad	52
6.4	Testing	52
6.4.1	Walk test	52
6.4.2	Communicator test	53
6.4.3	Battery/NAC circuits test	53
6.4.4	Activate outputs test	53
6.4.5	Input level test	53
6.4.6	MUX test	54
6.4.7	Sensitivity test	54
6.5	Point/Zone Mapping	55
6.6	Personal Identification Numbers (PINs)	56
6.7	Communicator Operation	57
7	Programming overview	59
7.1	Programming features	59
7.2	Point programming	60
7.3	Alpha programming	61
7.4	Format programming	63
7.5	Program menu tree	65
7.6	Shortcuts	66
7.7	Remote programming	67
8	Control panel programming	69
8.1	PROG TIME	69
8.1.1	Program time	69
8.1.2	Automatic test	70
8.1.3	Daylight saving time	70
8.2	SECURITY	71
8.2.1	Personal Identification Numbers (PINs)	71
8.2.2	Authority	72
8.3	PROG SYSTEM	72
8.3.1	Program timers	73
8.3.2	AC line synch	74
8.3.3	Option bus	75
8.3.4	PIN required	76
8.3.5	NAC silence mode	77
8.3.6	Remote programming	77
8.4	PROG INPUTS	77
8.4.1	Point number	78

8.4.2	Point function	81
8.5	PROG OUTPUTS	84
8.5.1	Programming NACs	84
8.5.2	Programming relays	86
8.6	PROG ACCOUNTS	88
8.6.1	Phone Numbers/IP Addresses	88
8.6.2	Phone Control	94
8.6.3	Report Steering	95
8.6.4	Ring Count	96
8.6.5	Communication Tries	97
8.6.6	Machine Bypass	97
8.6.7	ALT. COMM	97
8.7	PROG FORMATS	98
8.7.1	4/2 Zone Report	98
8.7.2	4/2 Report Codes	99
8.7.3	BFSK Report Codes	100
8.8	HISTORY DEFAULTS	100
8.8.1	Clear History	101
8.8.2	Default EE	101
8.8.3	Alternate 4/2 Codes	101
8.9	Program MUX	101
8.9.1	MUX Edit	102
8.9.2	MUX Bus Type	102
8.9.3	AUTO PROGRAM	103
8.9.4	Removing MUX Devices	106
9	Specifications	108
10	Appendices	110
10.1	Appendix A: Display Abbreviations	110
10.2	Appendix B: Panel Displays	111
10.3	Appendix C: Communicator Reporting Summary	112
10.4	Appendix D: Programming Defaults List	121
10.5	Appendix E: Phone Monitor Troubleshooting	129
10.5.1	COMM FLT/DATA LOST	129
10.5.2	Trouble Phone	130

1 Notices

1.1 Open Source Software Information

**Notice!**

For general information regarding open source software in Bosch Security Systems please visit <http://www.boschsecurity.com/oss>

This product may contain the following open source components:

OpenSSH license:

- `bsd-sprintf.c` from OpenSSH 6.6p1 (single file from OpenSSH 6.6p1)

1.1.1 License texts

Component: `bsd-sprintf.c` from OpenSSH 6.6p1

Version: single file from OpenSSH 6.6p1

URL: <http://www.openssh.com/>

License Type: OpenSSH license

This file is part of the OpenSSH software.

The licenses which components of this software fall under are as follows. First, we will summarize and say that all components are under a BSD license, or a license more free than that.

OpenSSH contains no GPL code.

1)

Copyright (c) 1995 Tatu Ylonen <yl@cs.hut.fi>, Espoo, Finland

All rights reserved

As far as I am concerned, the code I have written for this software can be used freely for any purpose. Any derived versions of this software must be clearly marked as such, and if the derived work is incompatible with the protocol description in the RFC file, it must be called by a name other than "ssh" or "Secure Shell".

However, I am not implying to give any licenses to any patents or copyrights held by third parties, and the software includes parts that are not under my direct control. As far as I know, all included source code is used in accordance with the relevant license agreements and can be used freely for any purpose (the GNU license being the most restrictive); see below for details.

However, none of that term is relevant at this point in time. All of these restrictively licensed software components which he talks about have been removed from OpenSSH, i.e.,

- RSA is no longer included, found in the OpenSSL library
- IDEA is no longer included, its use is deprecated
- DES is now external, in the OpenSSL library
- GMP is no longer used, and instead we call BN code from OpenSSL
- Zlib is now external, in a library
- The `make-ssh-known-hosts` script is no longer included
- TSS has been removed
- MD5 is now external, in the OpenSSL library
- RC4 support has been replaced with ARC4 support from OpenSSL
- Blowfish is now external, in the OpenSSL library

[The licence continues]

Note that any information and cryptographic algorithms used in this software are publicly available on the Internet and at any major bookstore, scientific library, and patent office worldwide. More information can be found e.g. at "<http://www.cs.hut.fi/crypto>".

The legal status of this program is some combination of all these permissions and restrictions. Use only at your own responsibility. You will be responsible for any legal consequences yourself; I am not making any claims whether possessing or using this is legal or not in your country, and I am not taking any responsibility on your behalf.

NO WARRANTY

BECAUSE THE PROGRAM IS LICENSED FREE OF CHARGE, THERE IS NO WARRANTY FOR THE PROGRAM, TO THE EXTENT PERMITTED BY APPLICABLE LAW. EXCEPT WHEN OTHERWISE STATED IN WRITING THE COPYRIGHT HOLDERS AND/OR OTHER PARTIES PROVIDE THE PROGRAM "AS IS" WITHOUT WARRANTY OF ANY KIND, EITHER EXPRESSED OR IMPLIED, INCLUDING, BUT NOT LIMITED TO, THE IMPLIED WARRANTIES OF MERCHANTABILITY AND FITNESS FOR A PARTICULAR PURPOSE. THE ENTIRE RISK AS TO THE QUALITY AND PERFORMANCE OF THE PROGRAM IS WITH YOU. SHOULD THE PROGRAM PROVE DEFECTIVE, YOU ASSUME THE COST OF ALL NECESSARY SERVICING, REPAIR OR CORRECTION.

IN NO EVENT UNLESS REQUIRED BY APPLICABLE LAW OR AGREED TO IN WRITING WILL ANY COPYRIGHT HOLDER, OR ANY OTHER PARTY WHO MAY MODIFY AND/OR REDISTRIBUTE THE PROGRAM AS PERMITTED ABOVE, BE LIABLE TO YOU FOR DAMAGES, INCLUDING ANY GENERAL, SPECIAL, INCIDENTAL OR CONSEQUENTIAL DAMAGES ARISING OUT OF THE USE OR INABILITY TO USE THE PROGRAM (INCLUDING BUT NOT LIMITED TO LOSS OF DATA OR DATA BEING RENDERED INACCURATE OR LOSSES SUSTAINED BY YOU OR THIRD PARTIES OR A FAILURE OF THE PROGRAM TO OPERATE WITH ANY OTHER PROGRAMS), EVEN IF SUCH HOLDER OR OTHER PARTY HAS BEEN ADVISED OF THE POSSIBILITY OF SUCH DAMAGES.

2)

The 32-bit CRC compensation attack detector in deattack.c was contributed by CORE SDI S.A. under a BSD-style license.

Cryptographic attack detector for ssh - source code

Copyright (c) 1998 CORE SDI S.A., Buenos Aires, Argentina.

All rights reserved. Redistribution and use in source and binary forms, with or without modification, are permitted provided that this copyright notice is retained.

THIS SOFTWARE IS PROVIDED ``AS IS" AND ANY EXPRESS OR IMPLIED WARRANTIES ARE DISCLAIMED. IN NO EVENT SHALL CORE SDI S.A. BE LIABLE FOR ANY DIRECT, INDIRECT, INCIDENTAL, SPECIAL, EXEMPLARY OR CONSEQUENTIAL DAMAGES RESULTING FROM THE USE OR MISUSE OF THIS SOFTWARE.

Ariel Futoransky futo@core-sdi.com

<<http://www.core-sdi.com>>

3)

ssh-keyscan was contributed by David Mazieres under a BSD-style license.

Copyright 1995, 1996 by David Mazieres <dm@lcs.mit.edu>.

Modification and redistribution in source and binary forms is permitted provided that due credit is given to the author and the OpenBSD project by leaving this copyright notice intact.

4)

The Rijndael implementation by Vincent Rijmen, Antoon Bosselaers and Paulo Barreto is in the public domain and distributed with the following license:

@version 3.0 (December 2000)

Optimised ANSI C code for the Rijndael cipher (now AES)

@author Vincent Rijmen vincent.rijmen@esat.kuleuven.ac.be

@author Antoon Bosselaers antoon.bosselaers@esat.kuleuven.ac.be

@author Paulo Barreto paulo.barreto@terra.com.br

This code is hereby placed in the public domain.

THIS SOFTWARE IS PROVIDED BY THE AUTHORS "AS IS" AND ANY EXPRESS OR IMPLIED WARRANTIES, INCLUDING, BUT NOT LIMITED TO, THE IMPLIED WARRANTIES OF MERCHANTABILITY AND FITNESS FOR A PARTICULAR PURPOSE ARE DISCLAIMED. IN NO EVENT SHALL THE AUTHORS OR CONTRIBUTORS BE LIABLE FOR ANY DIRECT, INDIRECT, INCIDENTAL, SPECIAL, EXEMPLARY, OR CONSEQUENTIAL DAMAGES (INCLUDING, BUT NOT LIMITED TO, PROCUREMENT OF SUBSTITUTE GOODS OR SERVICES; LOSS OF USE, DATA, OR PROFITS; OR BUSINESS INTERRUPTION) HOWEVER CAUSED AND ON ANY THEORY OF LIABILITY, WHETHER IN CONTRACT, STRICT LIABILITY, OR TORT (INCLUDING NEGLIGENCE OR OTHERWISE) ARISING IN ANY WAY OUT OF THE USE OF THIS SOFTWARE, EVEN IF ADVISED OF THE POSSIBILITY OF SUCH DAMAGE.

5)

One component of the ssh source code is under a 3-clause BSD license, held by the University of California, since we pulled these parts from original Berkeley code.

Copyright (c) 1983, 1990, 1992, 1993, 1995

The Regents of the University of California. All rights reserved.

Redistribution and use in source and binary forms, with or without modification, are permitted provided that the following conditions are met:

1. Redistributions of source code must retain the above copyright notice, this list of conditions and the following disclaimer.
2. Redistributions in binary form must reproduce the above copyright notice, this list of conditions and the following disclaimer in the documentation and/or other materials provided with the distribution.
3. Neither the name of the University nor the names of its contributors may be used to endorse or promote products derived from this software without specific prior written permission.

THIS SOFTWARE IS PROVIDED BY THE REGENTS AND CONTRIBUTORS ``AS IS'' AND ANY EXPRESS OR IMPLIED WARRANTIES, INCLUDING, BUT NOT LIMITED TO, THE IMPLIED WARRANTIES OF MERCHANTABILITY AND FITNESS FOR A PARTICULAR PURPOSE ARE DISCLAIMED. IN NO EVENT SHALL THE REGENTS OR CONTRIBUTORS BE LIABLE FOR ANY DIRECT, INDIRECT, INCIDENTAL, SPECIAL, EXEMPLARY, OR CONSEQUENTIAL DAMAGES (INCLUDING, BUT NOT LIMITED TO, PROCUREMENT OF SUBSTITUTE GOODS OR SERVICES; LOSS OF USE, DATA, OR PROFITS; OR BUSINESS INTERRUPTION) HOWEVER CAUSED AND ON ANY THEORY OF LIABILITY, WHETHER IN CONTRACT, STRICT LIABILITY, OR TORT (INCLUDING NEGLIGENCE OR OTHERWISE) ARISING IN ANY WAY OUT OF THE USE OF THIS SOFTWARE, EVEN IF ADVISED OF THE POSSIBILITY OF SUCH DAMAGE.

6)

Remaining components of the software are provided under a standard 2-term BSD license with the following names as copyright holders:

Markus Friedl
Theo de Raadt
Niels Provos
Dug Song
Aaron Campbell
Damien Miller
Kevin Steves
Daniel Kouril
Wesley Griffin
Per Allansson
Nils Nordman
Simon Wilkinson

Portable OpenSSH additionally includes code from the following copyright holders, also under the 2-term BSD license:

Ben Lindstrom
Tim Rice
Andre Lucas
Chris Adams
Corinna Vinschen
Cray Inc.
Denis Parker
Gert Doering
Jakob Schlyter
Jason Downs
Juha Yrjölä
Michael Stone
Networks Associates Technology, Inc.
Solar Designer
Todd C. Miller
Wayne Schroeder
William Jones
Darren Tucker
Sun Microsystems
The SCO Group
Daniel Walsh
Red Hat, Inc
Simon Vallet / Genoscope

Redistribution and use in source and binary forms, with or without modification, are permitted provided that the following conditions are met:

1. Redistributions of source code must retain the above copyright notice, this list of conditions and the following disclaimer.

2. Redistributions in binary form must reproduce the above copyright notice, this list of conditions and the following disclaimer in the documentation and/or other materials provided with the distribution.

THIS SOFTWARE IS PROVIDED BY THE AUTHOR ``AS IS" AND ANY EXPRESS OR IMPLIED WARRANTIES, INCLUDING, BUT NOT LIMITED TO, THE IMPLIED WARRANTIES OF MERCHANTABILITY AND FITNESS FOR A PARTICULAR PURPOSE ARE DISCLAIMED. IN NO EVENT SHALL THE AUTHOR BE LIABLE FOR ANY DIRECT, INDIRECT, INCIDENTAL, SPECIAL, EXEMPLARY, OR CONSEQUENTIAL DAMAGES (INCLUDING, BUT NOT LIMITED TO, PROCUREMENT OF SUBSTITUTE GOODS OR SERVICES; LOSS OF USE, DATA, OR PROFITS; OR BUSINESS INTERRUPTION) HOWEVER CAUSED AND ON ANY THEORY OF LIABILITY, WHETHER IN CONTRACT, STRICT LIABILITY, OR TORT (INCLUDING NEGLIGENCE OR OTHERWISE) ARISING IN ANY WAY OUT OF THE USE OF THIS SOFTWARE, EVEN IF ADVISED OF THE POSSIBILITY OF SUCH DAMAGE.

8) Portable OpenSSH contains the following additional licenses:

a) md5crypt.c, md5crypt.h

"THE BEER-WARE LICENSE" (Revision 42):

<phk@login.dknet.dk> wrote this file. As long as you retain this notice you can do whatever you want with this stuff. If we meet some day, and you think this stuff is worth it, you can buy me a beer in return. Poul-Henning Kamp

b) snprintf replacement

Copyright Patrick Powell 1995

This code is based on code written by Patrick Powell (papowell@astart.com) It may be used for any purpose as long as this notice remains intact on all source code distributions.

c) Compatibility code (openbsd-compat)

Apart from the previously mentioned licenses, various pieces of code in the openbsd-compat/ subdirectory are licensed as follows:

Some code is licensed under a 3-term BSD license, to the following copyright holders:

Todd C. Miller

Theo de Raadt

Damien Miller

Eric P. Allman

The Regents of the University of California

Constantin S. Svintsoff

Redistribution and use in source and binary forms, with or without modification, are permitted provided that the following conditions are met:

1. Redistributions of source code must retain the above copyright notice, this list of conditions and the following disclaimer.
2. Redistributions in binary form must reproduce the above copyright notice, this list of conditions and the following disclaimer in the documentation and/or other materials provided with the distribution.
3. Neither the name of the University nor the names of its contributors may be used to endorse or promote products derived from this software without specific prior written permission.

THIS SOFTWARE IS PROVIDED BY THE REGENTS AND CONTRIBUTORS ``AS IS'' AND ANY EXPRESS OR IMPLIED WARRANTIES, INCLUDING, BUT NOT LIMITED TO, THE IMPLIED WARRANTIES OF MERCHANTABILITY AND FITNESS FOR A PARTICULAR PURPOSE ARE DISCLAIMED. IN NO EVENT SHALL THE REGENTS OR CONTRIBUTORS BE LIABLE FOR ANY DIRECT, INDIRECT, INCIDENTAL, SPECIAL, EXEMPLARY, OR CONSEQUENTIAL DAMAGES (INCLUDING, BUT NOT LIMITED TO, PROCUREMENT OF SUBSTITUTE GOODS OR SERVICES; LOSS OF USE, DATA, OR PROFITS; OR BUSINESS INTERRUPTION) HOWEVER CAUSED AND ON ANY THEORY OF LIABILITY, WHETHER IN CONTRACT, STRICT LIABILITY, OR TORT (INCLUDING NEGLIGENCE OR OTHERWISE) ARISING IN ANY WAY OUT OF THE USE OF THIS SOFTWARE, EVEN IF ADVISED OF THE POSSIBILITY OF SUCH DAMAGE.

Some code is licensed under an ISC-style license, to the following copyright holders:

Internet Software Consortium.

Todd C. Miller

Reyk Floeter

Chad Mynhier

Permission to use, copy, modify, and distribute this software for any purpose with or without fee is hereby granted, provided that the above copyright notice and this permission notice appear in all copies.

THE SOFTWARE IS PROVIDED "AS IS" AND TODD C. MILLER DISCLAIMS ALL WARRANTIES WITH REGARD TO THIS SOFTWARE INCLUDING ALL IMPLIED WARRANTIES OF MERCHANTABILITY AND FITNESS. IN NO EVENT SHALL TODD C. MILLER BE LIABLE FOR ANY SPECIAL, DIRECT, INDIRECT, OR CONSEQUENTIAL DAMAGES OR ANY DAMAGES WHATSOEVER RESULTING FROM LOSS OF USE, DATA OR PROFITS, WHETHER IN AN ACTION OF CONTRACT, NEGLIGENCE OR OTHER TORTIOUS ACTION, ARISING OUT OF OR IN CONNECTION WITH THE USE OR PERFORMANCE OF THIS SOFTWARE.

Some code is licensed under a MIT-style license to the following copyright holders:

Free Software Foundation, Inc.

Permission is hereby granted, free of charge, to any person obtaining a copy of this software and associated documentation files (the "Software"), to deal in the Software without restriction, including without limitation the rights to use, copy, modify, merge, publish, distribute, distribute with modifications, sublicense, and/or sell copies of the Software, and to permit persons to whom the Software is furnished to do so, subject to the following conditions:

The above copyright notice and this permission notice shall be included in all copies or substantial portions of the Software

THE SOFTWARE IS PROVIDED "AS IS", WITHOUT WARRANTY OF ANY KIND, EXPRESS OR IMPLIED, INCLUDING BUT NOT LIMITED TO THE WARRANTIES OF MERCHANTABILITY, FITNESS FOR A PARTICULAR PURPOSE AND NONINFRINGEMENT. IN NO EVENT SHALL THE ABOVE COPYRIGHT HOLDERS BE LIABLE FOR ANY CLAIM, DAMAGES OR OTHER LIABILITY, WHETHER IN AN ACTION OF CONTRACT, TORT OR OTHERWISE, ARISING FROM, OUT OF OR IN CONNECTION WITH THE SOFTWARE OR THE USE OR OTHER DEALINGS IN THE SOFTWARE

Except as contained in this notice, the name(s) of the above copyright holders shall not be used in advertising or otherwise to promote the sale, use or other dealings in this Software without prior written authorization.

*****/

OpenBSD: LICENCE,v 1.19 2004/08/30 09:18:08 markus Exp \$

1.2 FCC Compliance Notice

This equipment was tested and found to comply with the limits for a Class A digital device, pursuant to Part 15 of the FCC Rules. These limits are designed to provide reasonable protection against harmful interference in a residential installation. This equipment generates, uses, and can radiate radio frequency energy. When it is not installed and used in accordance with the instructions, it might cause harmful interference to radio communications. There is no guarantee that interference will not occur in a particular installation. If this equipment does cause harmful interference to radio or television reception (that can be determined by turning the equipment off and on), then the user is encouraged to try to correct the interference by one or more of the following measures:

- Re-orient or relocate the receiving antenna.
- Increase the separation between the equipment and the receiver.
- Connect the equipment into an outlet on a circuit different from that to which the receiver is connected.
- Consult the dealer or an experienced radio or TV technician for help.

1.3 FCC Phone Connection to Users

This control panel complies with Part 68 of the FCC rules.

On the inside of the enclosure is a label that contains, among other information, the ringer equivalence number (REN) for this equipment. You must, upon request, provide this information to your local telephone company.

The REN is useful to determine the quantity of devices that can be connected to your telephone line and still have all of those devices ring when your telephone number is called. In most, but not all areas, the sum of the RENs of all devices connected to one line should not exceed five. To ascertain the number of devices that you can connect to your line, contact your local telephone company to determine the maximum REN for your local calling area. This equipment can not be used on coin service provided by the telephone company. Do not connect this control panel to party lines. If this equipment causes harm to the telephone network, then the telephone company might discontinue your service temporarily. The telephone company will notify you in advance if possible. But, when advance notice isn't practical, you will be notified as soon as possible.

You will be informed of your right to file a complaint with the FCC. The telephone company might make changes in its facilities, equipment, operations, or procedures that could affect the proper functioning of your equipment. If they do, then you will be notified in advance to give you an opportunity to maintain uninterrupted telephone service.

You should contact the manufacturer for information on obtaining service or repairs if you experience trouble with this equipment.

The telephone company might ask that you disconnect this equipment from the network until the problem is corrected or until you are sure that the equipment is not malfunctioning. The manufacturer, not the user, must make the repairs to this equipment. To guard against accidental disconnection, there is ample room to mount the telco jack inside of the control panel cabinet.

The operation of this control panel might also be affected if events such as accidents or acts of God cause an interruption in telephone service.

1.4 Industry Canada Notice

The Industry Canada label identifies certified equipment. This certification means that the equipment meets certain telecommunications network protective, operational, and safety requirements. Industry Canada does not guarantee the equipment will operate to the user's satisfaction.

Before installing this equipment, users should ensure that it is permissible to be connected to the facilities of the local telecommunications company. The equipment must also be installed using an acceptable method of connection. The customer should be aware that compliance with the above conditions might not prevent degradation of service in some situations.

Repairs to certified equipment should be made by an authorized Canadian maintenance facility designated by the supplier. Any repairs or alterations made by the user to this equipment, or equipment malfunctions, might give the telecommunications company cause to request the user to disconnect the equipment.

Users should ensure for their own protection that the electrical ground connections of the power utility, telephone lines, and internal metallic water pipe system, if present, are connected together. Users should not attempt to make such connections themselves, but should contact the appropriate electric inspection authority or electrician.

1.5 NFPA Standard 72

NFPA 72 (the national fire alarm code for the United States) is one of the standards referenced in this *Installation and Operation Manual*. Current editions of this standard are available at a nominal cost from: The National Fire Protection Association, Batterymarch Park, Quincy, MA 02269.

Older editions of the standard identified circuit types by Class and Style. The newer editions use Class only. The following table identifies the relationship between the older and newer designations.

New Designation	Old Designations			
	IDC	NAC	SLC	Supplementary
Class B	Class B, Style B Class B, Style C	Class B, Style Y	Class B, Style 4	
Class A	Class A, Style D Class A, Style E	Class A, Style Z	Class A, Style 6	
Class X			Class A, Style 7	
Class E				Non-supervised

Tab. 1.1: NFPA 72 circuit designations

1.6

Trademarks

All hardware and software product names used in this document are likely to be registered trademarks and must be treated accordingly.

2

Fire Safety

**Danger!**

No fire detection device or system is 100% foolproof.

This fire alarm system can provide early warning of a developing fire. Such a system, however, does not ensure protection against property damage or loss of life resulting from a fire. Any fire alarm system can fail to warn for any number of reasons (such as smoke not reaching a detector that is behind a closed door).

**Notice!**

This system must be regularly tested (when installed, when modified, and at least annually thereafter) to ensure continued performance.

When considering detectors for residential applications, refer to NFPA Standard 72, The National Fire Alarm Code. This standard is available at a nominal cost from: The National Fire Protection Association, Batterymarch Park, Quincy, MA 02269.

2.1

Having and practicing an escape plan

A fire warning can be wasted unless the personnel planned in advance for a rapid and safe exit from the building.

Draw a floor plan of the entire building showing two exits from each sleeping area and two from the building. Since stairwells and hallways can be blocked during a fire, provide exits from sleeping area windows. Make copies of the plan and practice it with all personnel.

Arrange a meeting place outside and away from the building. Once out of the building, all occupants should immediately go to the pre-selected location to be accounted for.

Provide a barricade between personnel and fire, smoke, and toxic gases (such as closing all sleeping area doors before retiring).

Instruct children on opening their bedroom windows and exiting safely from the building. If exiting is not possible, then teach them to stay at the open window and shout for help until it arrives.

If a fire alarm occurs after retiring, then wake the children by shouting to them from behind your closed door. Tell them to keep their bedroom doors closed.

If the top of your bedroom door is uncomfortably hot, then do not open it. There is most likely fire, intolerable heat, or smoke on the other side. Shout to all family members to keep their bedroom doors closed and to exit the building by alternate routes.

If the top of the door is not uncomfortably hot, then brace the bottom of the door with your foot and the top with one hand, then open the door about one inch. Be prepared to slam the door shut if there is any pressure against the door or if any hot air rushes in.

If there is no evidence of excessive heat or pressure, then leave the room and close the door behind you. Shout appropriate instructions to all family members and immediately leave the building by the planned routes. If heavy smoke is present, then drop to your hands and knees and crawl to remain below the smoke level.

3 Overview

3.1 System overview

The FPD-7024 Fire Alarm Control Panel is a fully integrated hard-wire fire alarm system. It supports four initiating device circuits (IDCs) which can be expanded to eight by adding an FPC-7034. An additional 247 addressable points can be added using a D7039 or FPE-7039 Multiplex Expansion Module. The control panel has a built-in LCD keypad. Up to four additional keypads can be used to provide user interface with the system and programming access for the installer. The FPD-7024 also includes the following features:

- Built-in dual-line communicator
- Multilanguage built-in with display text in English, Spanish, or Portuguese and symbols on keypads
- Menu driven keypad programming
- Freely programmable alphanumeric/alphabetical display
- 99 event history buffer
- 16 user codes
- UL Listed, CSFM, MEA Approved

When the Multiplex Expansion Module is installed, these additional features are available:

- 247 additional addressable input points (255 total points)
- 499 Non-volatile event history buffer
- 100 user codes

For the location of the major items on the FPD-7024 Control Board, see the following figure:

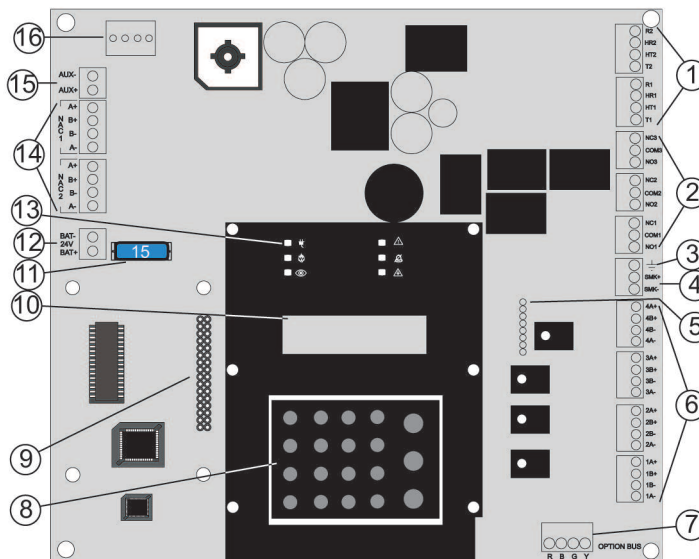

Figure 3.1: FPD-7024 control board

1	TELCO terminal blocks	2	Relay terminal blocks
3	Ground terminal	4	Smoke power terminal block
5	FPC-7034 point expander connector pins	6	Zone input terminal blocks
7	Option bus terminal block	8	Keypad
9	MUX expansion module connector pins	10	LCD display
11	Fuse (15 A)	12	Battery terminal block

13	LEDs	14	NAC terminal blocks
15	Auxiliary power terminal block	16	Transformer secondary terminal block

3.2 Components

3.2.1 On-board conventional points

All on-board points and points implemented with the FPC-7034 work with two- or four-wire detectors. The on-board conventional points have an optional alarm verification feature.

Number of two-wire circuits	Four circuits, expandable to eight using an FPC-7034 Expander
Type of Circuit	Class B and Class A (as needed)
EOL Resistor	2.21 kΩ (P/N: 25899 or F01U034504), UL listed
Supervisory Existing	8 mA to 20 mA
Required Existing for Alarm	25 mA
Maximum Short Circuit Existing	46 mA
Maximum Line Resistance	150 Ω
Circuit Voltage Range	20.4 VDC to 28.2 VDC
Maximum Detectors per Point	20 detectors (two-wire)
Total Detector Standby Existing	3 mA maximum
Response Time ¹	Either fast (500 ms) or programmable (from 1 second to 89 seconds)
Dirty Detector Monitoring	Implements Bosch Security Systems, Inc. Chamber Check and GE Interlogix, Inc. CleanMe protocol to monitor conventional loops for dirty detectors.

¹ See Loop response in *Point function, page 81*

Tab. 3.2: Two-wire circuits

All on-board points, and points activated with the FPC-7034 Four Point Expander, are continuously monitored for detectors signaling a dirty condition using the Bosch Security Systems, Inc. Chamber Check and GE Interlogix, Inc. CleanMe protocols. To prevent nuisance reports, dirty trouble (both annunciated and restored) on panel can have a response lag.

3.2.2 Off-board addressable points



Notice!

Off-board addressable points are only available when a Multiplex Expansion Module is installed on the FACP.

The Multiplex Expansion Module adds:

- Two Class B or one Class A Signaling Line Circuit (SLC)

- Each point is individually supervised for proper connection to the common bus (when over 30 points are troubled, the 30 troubles are shown and the balance of the troubles is indicated by a “MORE, SEE HISTORY” message).
- Response time can be set to fast, or programmed from 1 to 89 seconds.
- Input points on the SLCs are implemented with a D7042 Eight Input Remote Module.

3.2.3 Enclosure Housing

The standard enclosure is 18 ga., cold-rolled steel, and measures 20.75 in. x 15 in. x 4.25 in. (52.7 cm x 38.1 cm x 10.8 cm). A keyed lock is included, and the LEDs and LCD display are visible through the door.

3.2.4 Remote LCD Keypads

Maximum number of keypads: Four FMR-7033 LCD Fire Keypads.

For wiring requirements, see *Option bus wiring requirements, page 43*.

3.2.5 Remote LED Annunciators

Maximum number of annunciators: Eight D7030 eight-zone LED Annunciators.

For wiring requirements, see *Option bus wiring requirements, page 43*.

3.2.6 D7032 - use with the D7030X

When a D7032 Eight-Zone LED Annunciator Expander is connected to the D7030X, eight additional LED zones appear. This allows the D7030X/D7032 combination to show 16 LED zones. Up to eight D7030X/D7032 combinations can be connected to the FPD-7024 Fire Alarm Control Panel.



Notice!

Each D7030X processes 16 zones of information. If no D7032 is attached, then only the lower eight zones are shown.



Notice!

The column labeled “shown on D7030X” in the LED assignments table below applies regardless if an attachment of a D7032 to any D7030X is made.

For LED assignments when up to eight D7030X/D7032 combinations are used, see the following table:

D7030X	zones covered	shown on D7030X	shown on D7032 (if attached)	comments
1	1 to 16	1 to 8	9 to 16	Combination with lowest option bus address (such as Address 1)
2	17 to 32	17 to 24	25 to 32	Combination with second lowest option bus address (such as Address 2)
3	33 to 48	33 to 40	41 to 48	Combination with third lowest option bus address (such as Address 3)

D7030X	zones covered	shown on D7030X	shown on D7032 (if attached)	comments
4	49 to 64	49 to 56	57 to 64	Combination with fourth lowest option bus address (such as Address 4)
5	1 to 16	1 to 8	9 to 16	Fifth combination repeats first combination
6	17 to 32	17 to 24	25 to 32	Sixth combination repeats second combination
7	33 to 48	33 to 40	41 to 48	Seventh combination repeats third combination
8	49 to 64	49 to 56	57 to 64	Eighth combination repeats fourth combination

Tab. 3.3: LED assignments for LED Annunciators

For the LED display for Zones 49 to 64, see the following table.

LED	Zone	Description
1	49	User defined
2	50	User defined
3	51	(reserved)
4	52	General fire alarm monitor waterflow (non-silencable)
5	53	General fire alarm monitor (silencable)
6	54	(reserved)
7	55	General Supervisory (silencable)
8	56	General Waterflow (silencable)
9	57	(reserved)
10	58	General supervisory alarm (non-silencable)
11	59	(reserved)
12	60	(reserved)
13	61	General waterflow alarm (non-silencable)
14	62	(reserved)
15	63	General Alarm, Supervisory, and Waterflow (non-silencable): active while any alarm is present; remains active even while system is silenced
16	64	(reserved)

Tab. 3.4: LED display for Zones 49 to 64

3.2.7

Communicator

The communicator can report to two phone numbers or IP addresses with full single, double, and back-up reporting. It communicates in SIA, Modem IIIa², Contact ID, BFSK, and 3/1 and 4/2 formats (available communication formats depend on phone or IP connection).



Notice!

The communicator must be enabled and configured to operate. The communicator and phone line monitors are disabled in the default factory configuration.

Phone Line and Phone Number/IP Selection: To ensure the delivery of critical reports, the fire panel has two phone lines and two phone numbers or IP addresses that can be used for reporting. Reports can be directed to one or both of two phone numbers or IP addresses using the Report Steering feature in the control panel programming. Note that Account Number 1 is used with Phone Number/IP 1, and Account Number 2 is used with Phone Number/IP 2. Except for test reports, the control panel automatically selects the phone line or IP address to use. If the report is not successful after two attempts on Line 1, then the control panel automatically switches and uses Phone Line 2. One exception is when test reports (manual or automatic) are sent. Test reports are sent every 4 hours to 28 days. Each time a test report is sent, the control panel alternates phone lines. If the user sends two manual test reports, then both phone lines can be tested. The first report uses one line, and the second uses the other line. During normal operation, the automatic test uses both lines each time. Because the control panel automatically selects which line to use, both phone lines must use the same dialing sequences for sending reports. For example, a line that requires a 9 to be dialed for an outside line cannot be paired with a line that does not require a 9. For more information on report steering, see *Report Steering, page 95*.



Notice!

PBX lines and ground start lines do not comply with NFPA requirements for digital communication.

While the control panel is idle, the FACP monitors the primary and alternate telephone lines by monitoring the line for trouble. The FACP monitors each line every 12 seconds. When a trouble still exists after three samples (36 seconds), the FACP sends a trouble report and activates the yellow trouble LED and trouble relay.



Danger!

When the central station receives the automatic test report only every other day, this indicates that one phone line at the protected premises is inoperative.

Check that Report Steering is set for PHONE/IP 1 ONLY or PHONE/IP 2 ONLY. If not, correct this immediately because other critical reports can be delayed when the communicator is trying to send the test signal through the inoperative phone line (once each 48 hours).

Supplemental Reporting: While two independent phone lines are required for UL864 Central Station service, the FACP can be configured with one phone line if the control panel is used only for supplemental reporting on a local, remote station or auxiliary system.

To install the control panel with only one phone line, connect a jumper from T1 to T2 and a jumper from R1 to R2. These jumper connections are shown in the following figure:

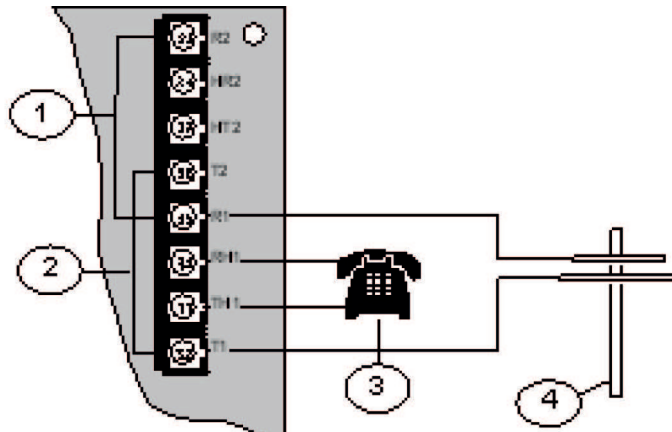

Figure 3.2: Supplemental Reporting

1	Jumper from R1 to R2	3	House phone
2	Jumper from T1 to T2	4	TELCO line

3.2.8

Users

The system allows up to 16 individual users or up to 100 users when the Multiplex Expansion Module is installed. A personal identification number (PIN, the four-digit code entered at the keypads) and an authority level to determine which functions can be performed can be assigned to each user.

For PINs, see *Personal Identification Numbers (PINs)*, page 56.

3.2.9

Lightning protection



Notice!

This system is intended for installation entirely within one building.

Metal-oxide varistors (MOVs) and spark gaps provide protection from lightning surges and static discharges

3.2.10

Battery backup calculation

When a power failure occurs, your control panel has back-up batteries that continue to power the system for the calculated battery backup time. The control panel automatically recharges the battery when power is restored. To calculate the standby battery capacity required by NFPA, see the two following tables:

Device	Quantity	Standby existing/device	Total standby	Alarm existing/device	Total alarm
FPD-7024 Control Panel	1	220 mA	220 mA	380 mA	380 mA
FMR-7033 Keypad ¹		80 mA		100 mA	
FMR-7036 Annunciator Keypad		80 mA		100 mA	

Device	Quantity	Standby existing/device	Total standby	Alarm existing/device	Total alarm
D7030X Eight-Point LED Annunciator ¹		27 mA		132 mA	
D7030X-S2 Eight-Point LED Annunciator		35 mA		175 mA	
D7030X-S8 Eight-Point LED Annunciator		35 mA		175 mA	
D7032 Eight- Point LED Annunciator Expander		1 mA		90 mA	
D7042/B Addressable Eight Point Input		18 mA		18 mA	
FPC-7034 Four-Point Expander		60 mA		184 mA	
D7035/B Octal Relay ¹		8 mA + 30 mA ²		8 mA + 30 mA ²	
D7048/B Octal Driver Module		10 mA		10 mA	
FPE-7039 MUX Expansion Module		190 mA		190 mA	
D7039 MUX Expansion Module		150 mA		150 mA	
D7044 MUX Single Input Fire		0.55 mA		0.55 mA	
D7044M MUX Mini Contact Module		0.55 mA		0.55 mA	
D7050 MUX Photoelectric Smoke Detector		0.50 mA		0.56 mA	

Device	Quantity	Standby existing/device	Total standby	Alarm existing/device	Total alarm
D7050TH MUX Photoelectric Smoke/Heat Detector		0.50 mA		0.56 mA	
D7052 MUX Dual Input Fire		0.55 mA		0.55 mA	
D7053 MUX I/ O Module Fire		0.70 mA		0.70 mA	
FMM-7045/-D MUX Pull Stations		0.55 mA		0.55 mA	
Smoke Detectors					
Bells, Horns, and so on					
Other Sensors					
Other					
		Grand Total Standby Existing		Grand Total Alarm Existing	
¹ The 24 VDC existing requirements for the D7030X, FMR-7033 and D7035 are shown at 75% of the 12 VDC level shown on the specification sheets for these models. The FACP regulates 24 VDC power from the battery to 12 VDC for these accessories. ² Add 30 mA for each relay activated					

Tab. 3.5: Standby battery capacity calculations

The units shown in the following table are Amp hours (Ah), and the calculations include a 20% derating factor.

Grand Total Standby Existing (in amps)	CS
Total Hours of Standby Required (usually 24 or 60):	HS
Total Standby Capacity (multiply CS x HS)	TS= CS x HS
Grand Total Alarm Existing (in amps)	CA
Total Hours of Alarm Time Required (usually 0.083 or 0.25):	HA
Total Standby Capacity (multiply CA x HA)	TA= CA x HA
Total Capacity Required (add TA + TS):	TC = TA + TS

Required Capacity with 20% Derating	$C = TC \div 0.8$
-------------------------------------	-------------------

Tab. 3.6: Required battery size calculation

3.2.11 Required batteries for existing load

Estimate the size of the battery required to support the standby load and alarm load using the following tables:

Grand Total Standby Existing	Capacity required for 24 h	Capacity required for 48 h	Capacity required for 60 h
100 to 200 mA	5.8	11.5	14.4
201 to 300 mA	8.6	17.3	21.6
301 to 400 mA	11.5	23.0	28.8
401 to 500 mA	14.4	28.8	36.0
501 to 600 mA	17.3	34.6	X
601 to 700 mA	20.2	X	X
701 to 800 mA	23.0	X	X
801 to 900 mA	25.9	X	X
901 to 1000 mA	28.8	X	X
1001 to 1100 mA	31.7	X	X

Tab. 3.7: Standby load battery size chart

Grand Total Alarm Existing	Capacity required for 5 min	Capacity required for 10 min	Capacity required for 15 min	Capacity required for 30 min	Capacity required for 45 min
250 to 500 mA	0.1	0.1	0.2	0.3	0.5
501 to 999 mA	0.1	0.2	0.3	0.6	0.9
1.0 to 1.5 A	0.2	0.3	0.5	0.9	1.4
1.6 to 2.0 A	0.2	0.4	0.6	1.2	1.8
2.1 to 2.5 A	0.3	0.5	0.8	1.5	2.3
2.6 to 3.0 A	0.3	0.6	0.9	1.8	2.7
3.1 to 3.5 A	0.4	0.7	1.1	2.1	3.2
3.6 to 4.0 A	0.4	0.8	1.2	2.4	3.6

Tab. 3.8: Alarm load battery size chart

3.2.12

Compatible devices

Device	Function
B420, B426, or DX4020 module	Manages secure, two-way IP communications over Ethernet networks.
B450 with B440, B441, B442, or B443 module or ITS-DX4020-G module	Enables two-way IP or dialed communications over a commercial GPRS/GSM network. Typical applications are event reporting to a central monitoring station and remote access to Bosch control panels. May require an appropriate SIM card and data plan.
D7030 Eight Point LED Annunciator	Identifies the location of a fire alarm for up to eight zones allowed per system.
D7030X Eight Point LED Annunciator	Identifies the location of a fire alarm for up to eight zones allowed per system.
D7030X-S2 Eight Point LED Annunciator	An eight zone LED annunciator, of which two zones are reserved for supervisory functions. It has Power and Trouble LEDs plus eight zone LEDs that can be labeled individually.
D7030X-S8 Eight Point LED Annunciator	An eight-zone LED annunciator, of which all eight zones are reserved for supervisory functions. It has Power and Trouble LEDs plus eight-zone LEDs that can be labeled individually.
D7032 Eight Point LED Annunciator Expander	Attaches to a D7030X and identifies the location of a fire alarm for eight additional zones.
D7035/B Octal Relay Module	Provides eight Form C relay outputs for addition to the system. The outputs are programmable and can be activated by system events. Each output operates independently of the other seven outputs for complete flexibility. The D7035 connects to the option bus; up to two are allowed per system. The D7035B comes installed on a mounting skirt. For required enclosure modification, see also the D7035 Installation Guide.
D7042/B Eight-Input Remote Module	Provides eight Class B input points. Connect up to 10 modules to MUX Bus A, and 10 on MUX Bus B. The D7042 is powered by 12 VDC supplied by the option bus power terminals, in addition to the two-wire data connection. The D7042 cannot be used on a MUX bus for Class A configuration and operation.
D7044 MUX Single Input Module	Connects a normally-open contact device to the multiplex bus of the FPD-7024 with a supervised local loop and draws operating power from the FPD-7024.

Device	Function
D7044M MUX Mini Contact Module	Connects a contact device to the multiplex bus of the FPD-7024 with a supervised input loop. The D7044 draws operating power from the FPD-7024.
D7048/B Octal Driver Module	Provides eight open-collector transistor outputs for addition to the FPD-7024. Connects to the control panels through the option bus.
D7050/TH MUX Smoke Detector	Photo-electric smoke detector with a heat option that connects to the multiplex bus of the FPD-7024 and draws operating power from the FPD-7024.
D7052 MUX Dual Input Fire	Provides two supervised input zones for connecting conventional normally-open inputs. Connects to the multiplex bus of the FPD- 7024 and draws operating power from the FPD-7024.
D7053 MUX I/O Module Fire	Implements a supervised local loop and a Form C relay output. Connects to the multiplex bus of the FPD-7024 and draws operating power from the FPD-7024. Up to 20 modules can be connected to each MUX bus.
DX4010V2 USB/Serial Interface Module	Creates a local connection between the FPD-7024 and approved applications. The module connects to the option bus of the FPD-7024 and draws operating power from the FPD-7024.
FLM-7024-ISO MUX bus isolator module	When placed between devices on the FPD-7024's MUX bus, a short on the bus causes activation of the isolators adjacent to either side of the short. This effectively separates all devices between the activated isolators from the rest of the bus. This prevents failure of the entire bus. When the short condition is removed, the isolators automatically restore the entire loop to normal operation.
FMM-7045/-D MUX Pull Stations	UL Listed fire alarm initiating devices.
FMR-7033 Alphanumeric LCD Keypad	Combines remote annunciator and controller functions for the FPD-7024. Up to four keypads can be connected.
FMR-7036 Fire Annunciator Keypad	Establishes the location of a fire alarm.
FPC-7034 Four Point Expander	Plugs into the control panel and provides four loops that are identical in characteristics to the loops on the control panel (allows the FPD-7024 FACP to support four additional loops). One FPC-7034 is allowed per system.

Device	Function
FPE-7039 or D7039 Multiplex Expansion Module	Provides either 2 two-wire Class B multiplex buses or 1 four-wire Class A multiplex bus. In Class A mode, up to 120 addressable points can be added. In Class B Mode, up to 247 addressable points can be added. The module connects directly to the control panel. One is allowed per system.
FPP-RNAC-8A-4C Remote NAC Power Supply	Connects to the option bus of the FPD-7024 and adds four NFPA 72 Class B Notification Appliance Circuits supervised by the control panel. Up to four are allowed per system.

Tab. 3.9: Compatible devices

Install D7042 modules only at addresses:							
9	17	25	33	41	49	57	65
73	81	89	97	105	113	121	129
137	145	153	161	169	177	185	193
201	209	217	225	233	241		
Do not install D7052 and D7053 modules at these addresses:							
16	24	32	40	48	56	64	72
80	88	96	104	112	120	128	136
144	152	160	168	176	184	192	200
208	216	224	232	240	248	255	
Install B420, B426, B450/B440/B441/B442/B443 modules, DX4020, or ITS-DX4020-G modules only at addresses:							
134 ¹	250 ¹						
¹ An IP connection to RPS can only be created using an IP module at address 250; IP modules at both addresses 134 and 250 can be used for reporting.							

Tab. 3.10: Address restrictions for modules

4 Installation

4.1 UL Listed systems installation guide

4.1.1 FPD-7024 UL Listings

The FPD-7024 is UL Listed for the following:

- Commercial Fire Alarm (UL Standard UL864)
 - Type Service: Auxiliary, Local, Central Station, and Remote Station
 - Type Initiating: Automatic, Manual, Sprinkler Supervisory, and Waterflow

Install the control panel according to NFPA 72 for Commercial Fire installations.

4.1.2 Installation considerations

Failure to install and program the control panel according to the requirements in this section voids the listing mark of Underwriters Laboratories.

- The standby battery capacity is 7 Ah to 40 Ah at 24 VDC.
- The total nominal existing must not exceed 1.25 A in standby or 4 A when in alarm.
- The control panel must be mounted indoors and within the protected area.
- Grounding must be according to article 250 of the NEC (NFPA 70).
- Points must be connected to UL Listed, compatible devices.
- The ground wire provided with the enclosure must be connected between the door and the enclosure using the supplied nuts.
- Select Phone Monitoring if the digital alarm communicator transmitter (DACT) feature is used.

4.1.3 UL requirements



Notice!

The system must be tested after installation and after any re-programming, including programming performed by downloading.

When used in UL Listed installations, the control panel must conform to certain programming requirements. For acceptable programming selections for Listed applications that meet the requirements of the currently released edition of UL864, see *Programming features, page 59*.

Commercial Fire Alarm Systems



Notice!

This section applies to both Central Station and Local Fire Systems.

Required Accessories

- At least one Bosch Security Systems, Inc. Model F220-P Smoke Detector with an F220 Family Base; or another UL Listed compatible smoke detector.
- At least one Horn Strobe or Bell (provides 85 dB for UL985 and NFPA 72 requirements; other UL Listed compatible devices listed for regulated 24 V can be used) is required for this application and must be installed inside the protected area.
- Four-wire detectors must be used with UL Listed power supervision devices. A compatible UL Listed four-wire detector is the Bosch Security Systems, Inc. F220-P in an F220-B6 Family Base. Compatible UL Listed relays are the Bosch Security Systems, Inc. D275 and PAM-4.

- All points must be used with the resistor provided.

Report Programming

- Program non-supervisory and supervisory reports for those points used.
- Program trouble reports.
- Set AC Failure Report Delay for a delay of 1 hour to 3 hours.
- Set automatic test report frequency to occur at least every 24 hours (pre-NFPA72-2013; NFPA72-2013 requires 6 hrs max).

Timer Programming

- Program Auto Silence Time for not less than five minutes, or to "0" to disable auto-silence operation.

Point Programming

- For fire points: open = trouble, latching.

Alarm Output Programming

- Program notification appliance circuits to activate from the appropriate input points.

Communications Programming

- When used for Central Station Service, select a communication format compatible with the central station. Enable monitoring of both phone lines.

UL Listed Accessory Devices**D132B Multi-use Reversing Relay Module**

The D132B is a multi-purpose, fully configurable, smoke power-reversing module for activating detectors with local annunciation. The D132B operates both two-wire and four-wire circuits and also works with Class A or Class B initiating circuits. An alarm latch connection is provided to allow an initiating loop to be held in alarm after the detector loop power is reversed to activate any sounders. The D132B does not affect compatibility between the FACP and detectors, or the FACP and Notification Appliance Circuits (NACs).

For detailed installation instructions for the D132B module, see the *D132B Installation Guide*.

D185 Reverse Polarity Module

The D185 Reverse Polarity Module is a UL Listed module that connects the control panel with either a single set or a pair of leased telephone company (TELCO) lines in NFPA 72 remote station applications. It relays system alarm status information from the control panel to a monitoring station. The D185 operates with either 12 VDC or 24 VDC supply. All circuits are power limited and have a current between 2.5 mA and 15 mA with nominal current of 10 mA. For typical wiring of the D185 module, see the *D185 Installation Instructions*.

4.2 Installing the enclosure

To install the enclosure, follow these instructions:

1. Using the enclosure as a template, mark the top mounting holes on the mounting surface.
2. Start the mounting screws (not supplied) for these two holes.
3. Slide the enclosure onto these screws so that the screws rest on the thinner section of the holes.
4. Tighten the screws.
5. Install and tighten the remaining two screws in the bottom mounting holes.
6. Knock out the desired wire entrances on the enclosure.

For mounting hole locations, see the following figure:

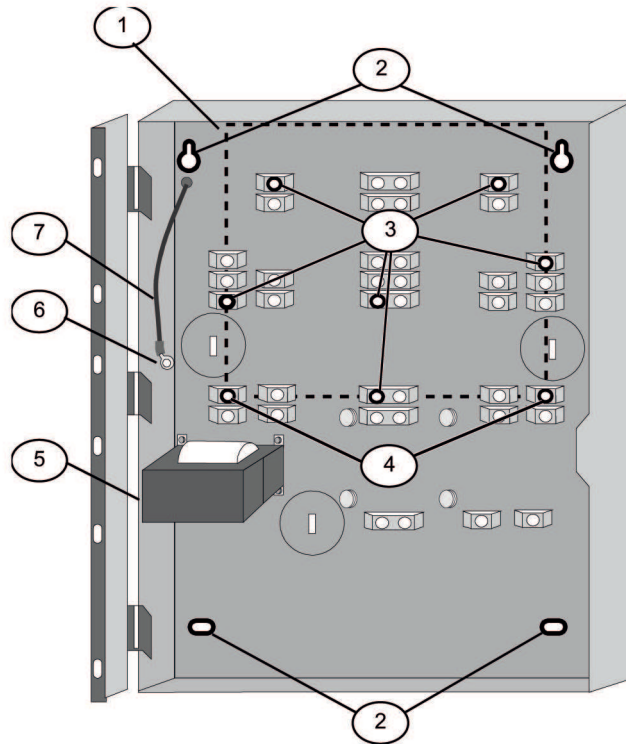

Figure 4.1: Enclosure installation

1	Control panel location	2	Mounting holes
3	Retainer holes for standoffs	4	Retainer holes for support posts
5	Transformer	6	Stud
7	Ground wire		

Warning!



The FPD-7024-LT needs an external power supply for operation!

The power supply must meet the following characteristics:

INPUT: 240 VAC; 50 HZ; 0.6 A; Class B

OUTPUT: 26.0 VAC; 5.5 A

Use of a power supply not having the same electrical characteristics may cause shock and serious injuries to persons or objects. Do **not** connect a power supply with characteristics different from those specified, since the equipment will be damaged.



Notice!

When using the knockouts located at the bottom of the enclosure, install batteries in a separate enclosure.

4.3 Installing the FACP



Danger!

The control circuit board is static sensitive. To avoid damage to sensitive components, touch ground before handling the control board. This discharges any static electricity in your body. For example, run the ground wire to the enclosure before handling the control circuit board. Continue touching the enclosure while installing the control board.



Warning!

Before the circuit board is installed, connect the supplied ground wires between the door and the enclosure and from the transformer to the enclosure using the supplied nuts. Both grounds connect to the stud in the enclosure to the left of the circuit board.

For installation illustrations, see the , page 31 and the , page 33.

1. Insert the three support posts in the enclosure’s retainer holes.
2. Press the 1/8 in. nylon standoffs (P/N: F01U034705) into the retainer holes.
3. Slide the top of the control panel onto the retainer tabs (the slots under the top of the frame). When the control panel is in the retainer tabs, it rests on the posts.
4. Secure the bottom of the circuit board by inserting and tightening the screws at the two bottom corners through the support posts and the retainer holes.

For installing standoffs and support posts, see the following figure:

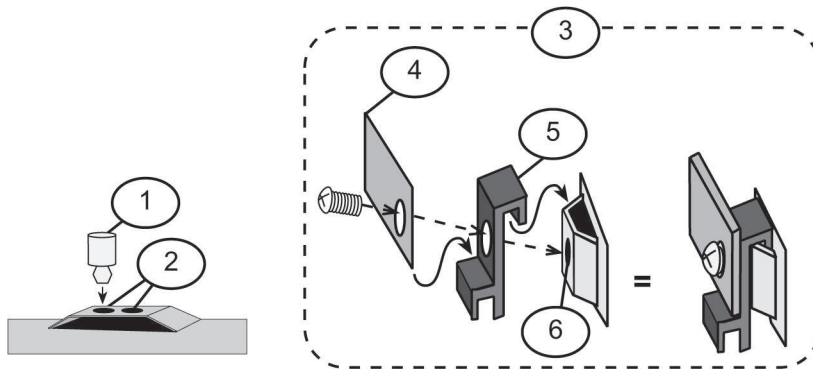

Figure 4.2: Standoff and support post installation

1	1/8 in. nylon standoff	4	Corner of circuit board
2	Retainer holes	5	Support post
3	Support post assembly	6	Retainer hole in enclosure

4.4 Installing optional equipment

Two expansion options connect directly to the control panel, and are automatically detected and supervised when the control panel is powered:

- FPC-7034 Four Point Expander
- FPE-7039 or D7039 Multiplex Expansion Module

When the control panel is powered after installing one of these options, the control panel displays one of the following windows:

4Z EXP DETECTED
PRESS BACK KEY

MUX DETECTED
PRESS BACK KEY

Press the  key to confirm the installation of the device and automatically set it up for supervision.

If the  key is not pressed during the power-up time-out period, the control panel resumes operation using the last confirmed status of the affected expander and displays an installation error condition.



Warning!

Expansion devices such as point expanders and multiplex expanders are disabled if they are removed from the control panel configuration after installation. You cannot disable supervision of these devices when they are installed.

For additional information, see the installation instructions for the specific expanders.



Notice!

EEPROM fault at first installation

When the Multiplex Expansion Module is first installed, the system displays an EEPROM fault. Execute the default procedure to synchronize the EEPROM on the expansion module to the EEPROM in the control panel. Remove power to the control panel, then reapply power and re-install option bus devices after the default procedure.





Notice!

Loss of programming

Replacing a Multiplex Expansion Module causes the loss of programming of expansion points and PINs. Reprogram all multiplex point and PINs if you replace the module.

When the Multiplex Expansion Module is first installed, or anytime the control panel is powered with a module that has no points programmed, the system automatically starts the multiplex auto-programming process:

AUTO PROGRAM?
_____:YES(1) NO(0)

Pressing the  key starts auto-programming and pressing  allows the control panel to continue normal startup. The menu automatically closes with NO selected if no key is pressed after several minutes.

For detailed instructions on the auto-programming mode, see *AUTO PROGRAM*, page 103.

4.5 Installing detection devices

General considerations

Proper location of detection devices is one of the most critical factors in a fire alarm system. Smoke detectors should not be installed in dead air spaces or close to ventilating or air conditioning outlets because smoke can be circulated away from the detector. Locations near air inlets are favored.

Avoid areas subject to normal smoke concentrations such as kitchens, garages, or near fireplaces.

Do not install smoke detectors where normal area temperatures are above +100°F (+38°C) or below +32°F (0°C).

Avoid areas of high humidity and dust concentrations.

For exact mounting information, refer to the instructions provided with the smoke detectors.

Family residences

Most fire deaths occur in the home, especially during sleeping hours. The minimum level of protection requires smoke detectors to be installed outside of each separate sleeping area and on each additional story of the dwelling.



Notice!

For added early warning protection, install detectors in all separate areas including the basement, bedrooms, dining room, utility room, furnace room, and hallways.

For residential smoke detector locations, see the chapter in NFPA 72 on Single- and Multiple-Station Alarms and Household Fire Alarm Systems.

5 Connection

5.1 FACP terminal connection

**Danger!**

Incorrect connections can result in damage to the unit and personal injury.

**Warning!**

Before servicing this equipment, remove all power including that from the transformer, battery and phone lines.

**Notice!**

Shared cable is not recommended for option bus, telephone or NAC wiring.

**Notice!**

All wiring except battery terminal and primary AC power is power-limited. Primary AC and battery wires must be separated from other wires by at least ¼ in. (64 mm) and tied to prevent movement.

Input Points 1-4:

Points (supervised) are intended for connection of normally-open/normally-closed contacts. They may also be used for compatible two-wire smoke detectors. All EOL resistors are 2.21 kΩ, P/N: 25899 or F01U034504 Bosch, UL listed. Initiating devices are Class B or Class A. Two-wire Compatibility Identifier "A".

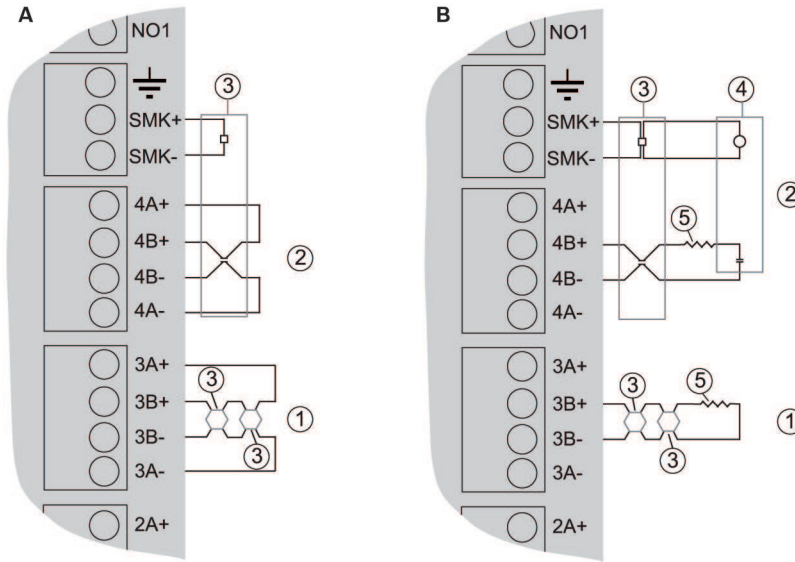

Figure 5.1: Initiating device wiring

A	Class A wiring	B	Class B wiring
1	Typical 2-wire initiating device wiring	2	Typical 4-wire initiating device wiring
3	Initiating device	4	EOL relay (PAM-4)
5	EOL resistor; 2.21 kΩ (P/N: 25899 or F01U034504), UL listed		



Notice!

For connection to listed power limited Class 2 or Class 3 sources only. Contacts rated at 5.0 A, 24 V.



Notice!

Smoke Power: 20.4 to 28.2 VDC, 1.0 A maximum (filtered).
For compatible devices, see also Technogram P/N: F01U010790.

Wiring integral trouble contacts

Initiating devices with integral trouble contacts must be connected to the IDC such that transfer of the trouble contacts does not impair alarm signaling from any other initiating device on that IDC. The following illustrates how to wire an IDC to meet this requirement:

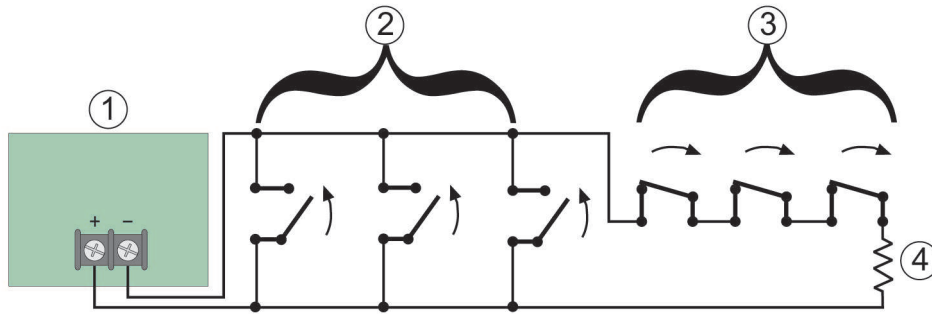

Figure 5.2: Wiring with integral trouble contacts

1	Alarm terminals on the control panel	2	Alarm contacts from all initiating devices on the IDC
3	Trouble contacts from all initiating devices on the IDC	4	EOL resistor

Connecting the FPC-7034

The optional FPC-7034 Four Point Expander adds four conventional points which are automatically detected and supervised when the control panel is powered.

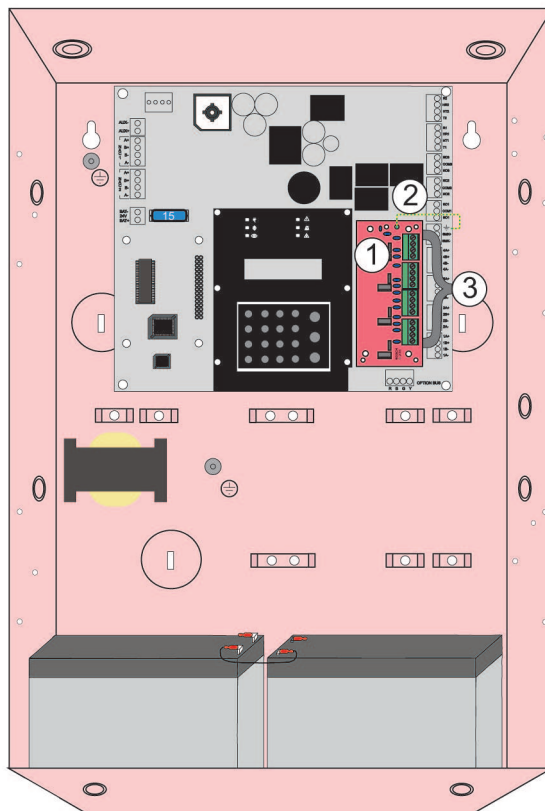

Figure 5.3: FPC-7034 Connections

1	FPC-7034 (connecting pins on back plug into terminal block on FPD-7024)	2	Ground wire
3	Four additional IDCs that are identical ¹ to the four on-board IDCs		

¹ The IDCs provided by the FPC-7034 cannot be programmed for Alarm Verification.

On-board relays:

The main control panel includes three Form “C” relays (Relay 1, Relay 2, and Relay 3). The relay contacts are rated at 5 A, 28 VDC. No over existing limiting is performed on the contacts of these relays. The default selection for the relays is to indicate general alarm and general system trouble and supervisory. By using point or zone mapping, they can be programmed to activate in a wide variety of conditions.



Notice!

When a local relay is programmed for trouble, it is energized in the normal state. This causes the common and normally open terminals to be shorted when not in the trouble condition.

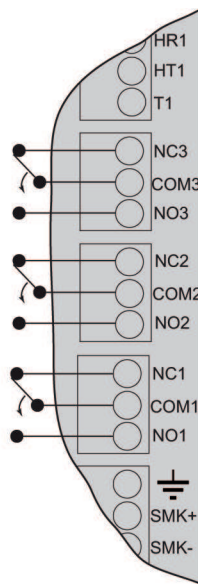

Figure 5.4: On-board relays

Phone line connections:

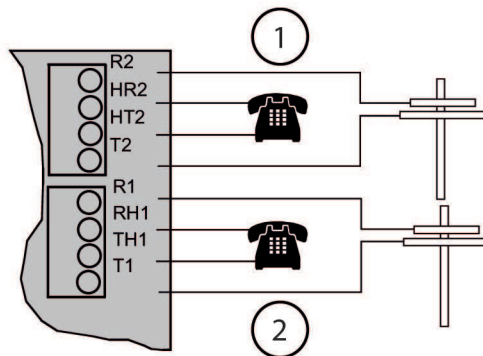

Figure 5.5: Telephone lines 1 and 2

1	Phone Line 2 (non-power-limited and supervised)	2	Phone Line 1 (non-power-limited and supervised)
---	---	---	---

Auxiliary power circuit and notification appliance circuits



Notice!

Unswitched unsupervised Auxiliary Power: 17 V to 31 V, 1.0 A maximum (unfiltered).

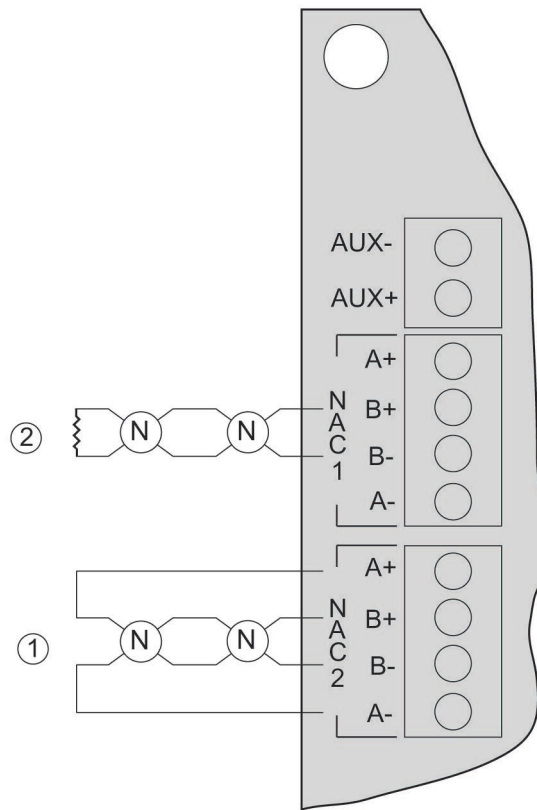

Figure 5.6: AUX power and NACs

1	Class A NAC	2	Class B NAC
---	-------------	---	-------------

Notification appliance circuits	
NAC +	+24 V while in alarm; ground while in standby.
NAC -	Ground while in alarm; supervision voltage while in standby.

Battery Connections and fuse

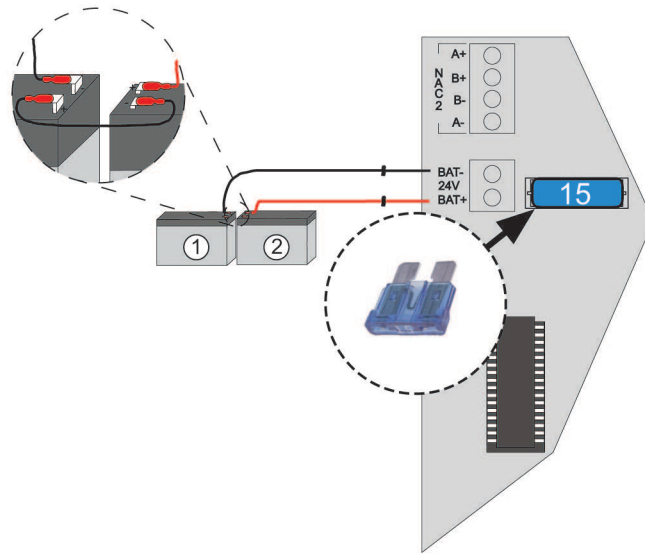

Figure 5.7: Battery connections and fuse

1	Battery 1 (12 Vdc in series with battery 2)	2	Battery 2 (12 Vdc in series with battery 1)
---	---	---	---



Danger!

Explosion and burn hazard!
Do not short terminals!

	Batteries:
BAT - BAT +	Requires two 12 V batteries in series, for a combined voltage of 24 V. Charge current = 1.7 A, maximum

MUX bus connections

The optional FPE-7039 Multiplex (MUX) Expansion module connects directly to the FACP for either two Class B MUX buses or one Class A MUX bus that allow up to 247 remote points which are automatically detected and supervised when the control panel is powered. For more information regarding Class A and Class B wiring instructions, see also the Multiplex Expansion Module’s Installation Guide. For mounting locations inside the FPD-7024’s enclosure and wiring possibilities for the Multiplex Expansion Module and its I/O module, see the following figure:

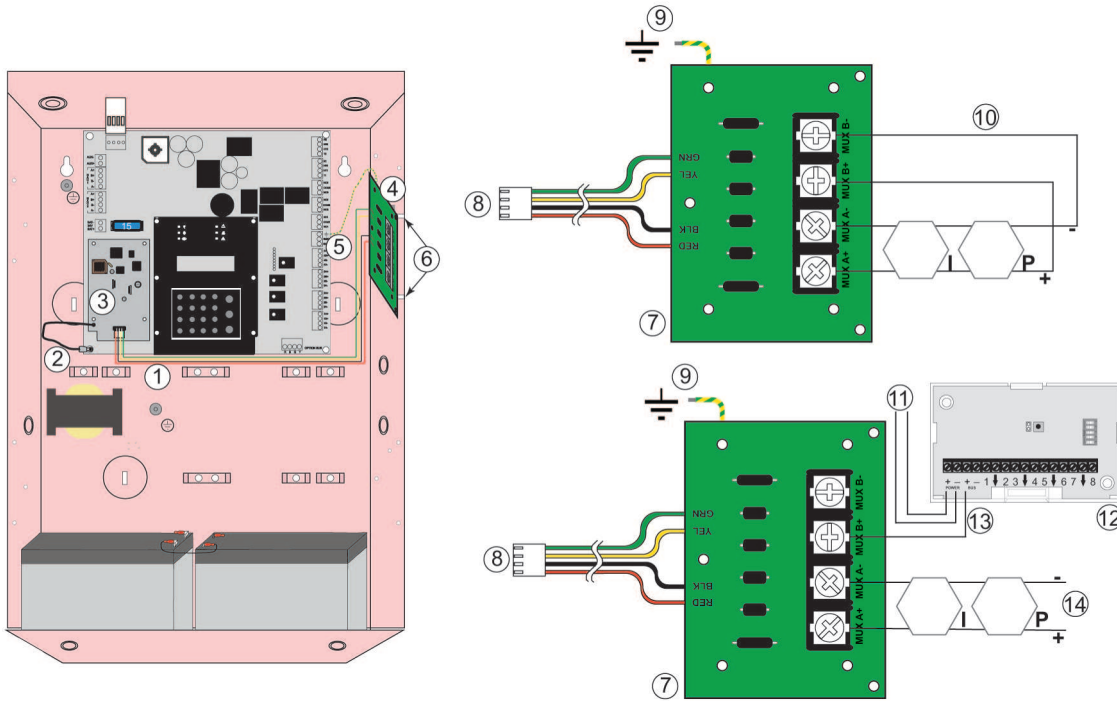

Figure 5.8: MUX_bus_connections

1	Connection between FPE-7039 and I/O module	2	Connection between FPE-7039 and FPD-7024 ground
3	FPE-7039 board	4	I/O module
5	Connection between I/O module and FPD-7024 ground terminal	6	Mounting standoffs for I/O module
7	I/O module (upper module shows Class A wiring); bottom module shows Class B wiring with D7042 and with EOL relay)	8	Connection between I/O module and FPE-7039 (see also callout 1)
9	Connection between I/O module and FPD-7024 ground terminal (see also callout 5)	10	MUX Class A (addresses 9 to 128)
11	Power connection to FPP-RNAC-8A-4C	12	D7042 Eight Point Input module
13	Connection (MUX+) between I/O module and D7042	14	EOL relay

Option bus connections

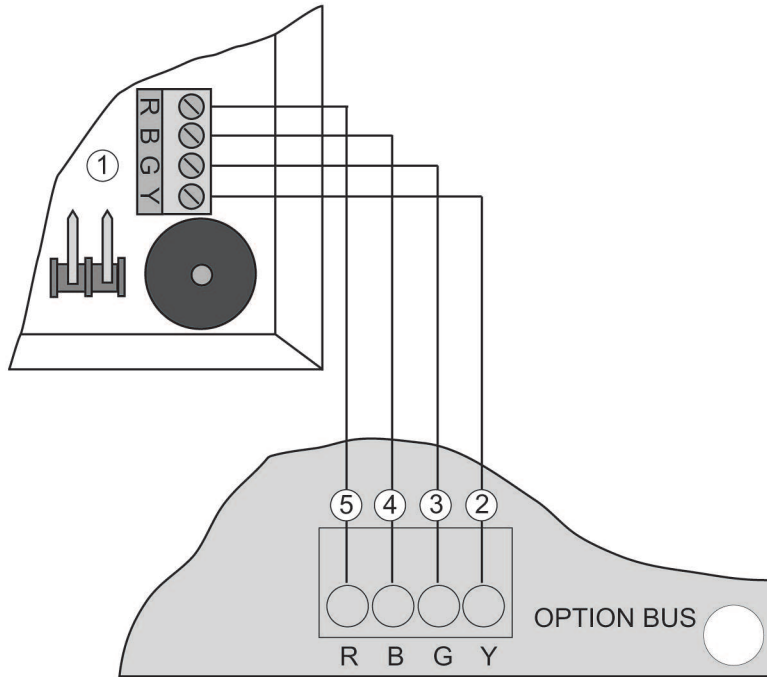

Figure 5.9: Option bus connection

1	Option bus device	2	Yellow wire (data)
3	Green wire (data)	4	Black wire (common)
5	Red wire (+12 V)		

5.2 Option bus wiring requirements

Use 18 AWG (ISO 0.75 mm²) or larger wire to connect option bus devices to the FACP. The total length of wire connected to the option bus terminals must not exceed 4000 ft. (1219 m), regardless of the wire gauge wire used.



Notice!

Shared cable is not recommended for option bus, addressable points bus, telephone, or NAC wiring.



Notice!

To comply with UL, do not share supplementary devices with primary device on the option bus.

Avoid shielded or twisted pair-wire except for special applications where a reduced length of wiring (approximately 50%) is acceptable for tolerating a harsh electrical environment.

The length of wire allowed between the control panel and the last device on a wiring run depends on the existing current draw on that wiring run. Reducing the number of devices on a wiring run allows the individual runs to be longer.

Add together the alarm existing current draw by all the devices on the wiring run to determine the maximum allowed distance between the option bus terminals on the control panel and the last device on the wire run (the device farthest from the control panel).

To determine the maximum allowed length for the run, add up the total alarm load for option bus devices on the wire run. For example, if the total load of option bus devices on a particular run is 400 mA, the maximum length of the run can be up to 500 ft. (152 m). No more than 4000 ft. (1219 m) of wire can be connected to the option bus terminals, even if the individual lengths of the runs are all within limit.

For the allowed lengths for 18 AWG (ISO 0.75 mm²) wire, see the following figure:

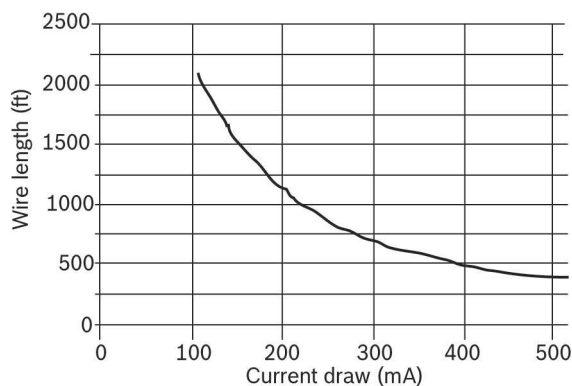

Figure 5.10: 18 AWG cable length for existing current draw



Notice!

The graph is for 18 AWG cable!

For 16 AWG (ISO 1.5 mm²) wire, cable lengths can be 1.5 times longer. For 14 AWG (ISO 2.5 mm²) wire, cable lengths can be 2.5 times longer. The 4000 ft. (1219 m) maximum length of connected wire still applies.

5.3 Power supply connection

Use wire nuts to connect the primary side of the transformer in one of the following ways:

- black and white wires to an unswitched 120 V, 60 Hz, or
- yellow and white wires to an unswitched 240 V, 50 Hz circuit.



Danger!

Shock risk

Due to risk of shock and/or damage to the transformer, a wire nut must be placed over the unused black or yellow wire.

Connect the earth ground to the threaded ground stud on the left side of the enclosure.

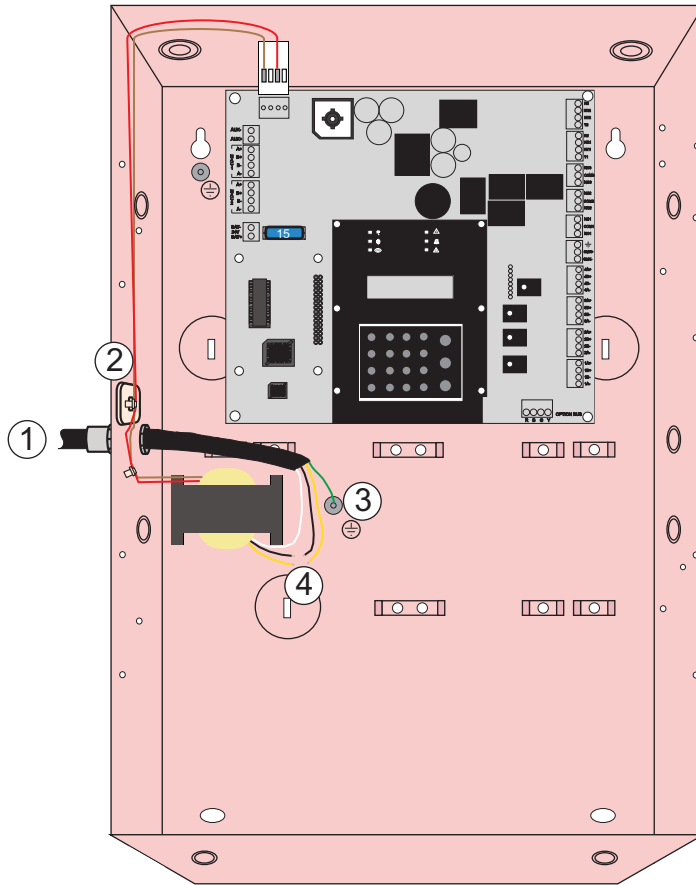

Figure 5.11: Transformer wiring

1	Supply wires (hot, neutral, and ground)	2	Secondary wire held in place by wire ties
3	Grounding post (connect to ground wire)	4	Primary wiring yellow: unswitched 240 V, 50 Hz, black: unswitched 120 V, 60 Hz, and white: common Use a wire nut on unconnected black or yellow wire.



Danger!

Electrical shock hazard

The unused yellow or black primary wire must have a wire nut on its end to prevent contact with the bare wire.

6 System operation

6.1 Modes of Operation

There are four modes of system operation for the FPD-7024: normal, alarm, supervisory, and trouble. Alarm, supervisory, and trouble are off-normal conditions.

6.1.1 Normal

When the system operates normally, it shows SYSTEM NORMAL on the top line of the display, the Power LED lights steadily, and no other LEDs are lit. The bottom line indicates the existing date MM/DD/YY and time HH:MM. If the system is programmed to require a PIN, then the second line of the LCD screen shows ENTER PIN.

6.1.2 Off-normal Displays

Control panel alarms and problems are indicated on the top line of the display. Contact your installing company if problems persist.

For the alarm/problem messages, see the following table:

Off-Normal Display	Description
XXX/XXX FIR: XXXXX	One or more fire or waterflow points are in alarm.
XXX/XXX SUP: XXXXX	One or more supervisory conditions exist.
XXX/XXX TRB: XXXXX	A trouble condition exists (AC power failure, phone line trouble, and so on).

Tab. 6.11: Off-normal displays

6.1.3 Acknowledge

When the control panel is off-normal, the control panel's piezo (buzzer) can be silenced without silencing the NACs or resetting the control panel. Press the [ACK] button on the local or remote keypad to silence only the piezo.

6.1.4 Alarm

When an alarm occurs, the top line shows the number of alarms and the point that is in alarm. The bottom line alternates between the instructions and the programmed description for the affected point. When you back out of the detail view and go to the group view by pushing the  key, the top line of the display shows ALARM (XXX), where XXX indicates the number of alarms. This display overrides any other system display. The built-in sounder turns on with a steady tone, and outputs programmed to activate with the existing alarm condition(s) activate.

When the control panel is not scanning the inputs, as during smoke power reset, or on-site programming, the trouble LED flashes to indicate this condition.

6.1.5 Supervisory

When a Supervisory condition occurs, the top line shows the number of supervisory conditions and the point that is in the supervisory condition. The bottom line alternates between the instructions and the programmed description for the affected point. When you back out of the detail view and go to the group view by pushing the  key, the top line of the display shows supervisory (XXX), where XXX indicates the number of supervisory conditions. The bottom line indicates more instructions. The built-in sounder beeps. Outputs programmed to activate with the existing condition(s) then activate.

6.1.6

Trouble

When a trouble condition occurs (such as cut wiring for a point or AC power fails), the sounder beeps every 10 seconds. The Trouble LED lights and the LCD shows the trouble condition. When you back out of the detailed screen when the  key is pressed the group is entered and shows TROUBLE (XXX). The system can diagnose and show a variety of trouble conditions, including those affecting the input points, NAC circuits, power, battery, system grounding, and internal operations of the fire control panel. Notify your installing company immediately if the system trouble message appears.

Press the key to silence the system trouble beep.

6.1.7

Fire Silence/Reset



Danger!

Fire Alarm!



During a fire alarm, exit from the premises immediately. Do not enter the premises unless accompanied by the appropriate emergency services' personnel, or until they have given the OK to enter.

When it is determined that there is no fire, then you can silence the horns or bells to allow more investigation of the devices that initiated the alarm, or you can reset the system to return it to normal operation.



Notice!

Before resetting fire alarms

Before using the  key, determine which smoke detector initiated the alarm so that the monitoring company can check that the system is operating correctly. When the control panel is being used as an addressable control panel, use the  key to determine which address is in alarm.

When the system is configured to allow alarm silencing, the  key turns off the horns or bells, but does not reset the alarm status and does not return the activated input to normal service. Detectors that were activated stay in alarm and can be checked (usually by observing an LED on the device) to see which detector caused the alarm. When the detectors causing the alarm are identified, reset the system to return it to normal service.

The  key clears the system alarm status, and briefly turns off power to the detectors to reset them. This command is required after any fire alarm affecting a point programmed for latching operation (which is the normal configuration). This operation is also required to reset Class A multiplex (SLC) wiring fault troubles.

The software automatically supervises the system software for proper operation. If the system fails, then a CPU FAULT message appears, and the nature of the failure can be optionally recorded in the history buffer. To enable history buffer recording for CPU faults, program Output Zone D of onboard Relay 2 to Zone 51 (unused). The history buffer message, if enabled, shows CPUFLTxxx, where xxx is an error code. If the display shows CPU FAULT, then contact Bosch Security Systems, Inc. Technical Support and report the history buffer code along with a description of the operations that caused the fault. Unusual conditions during programming and debugging operations can result in a CPUFLT message in the history buffer. If this occurs when the control panel is in service, then report it to Technical Service.





6.2 Basic System Use

6.2.1 Function keys

A keypad that does not require a PIN number shows (under normal conditions) SYSTEM NORMAL on the top line, and existing date and time on the bottom line. On a keypad that does require a PIN number, enter the PIN number first. This enables the function keys.

6.2.2 Selecting menu items

Depending on the level in the system (menu, sub-menu, sub-sub-menu), you can select an item three different ways:



1. TEST, HISTORY, DISABLE and DRILL each have an exclusive key on the keypad in the main menu. To select one of these menu items, press the corresponding key. For example, to select TEST, press the  key.
2. The  and  keys are not exclusive, but are shared with other characters. To select one of these items, press the corresponding key. For example, the  key is also 0.
3. The key corresponding to a sub-menu item might appear in the second line preceding a dash. Press the corresponding key to select that item. For example, press  to select PROG TIMES.

While a menu is active, you do not need to wait for the desired menu item to appear before making your selection. You can select any item on the existing menu rotation at any time.



6.2.3 After Main Menu item selected

When a main menu item is selected, the keypad might prompt you to enter your PIN. If so, enter the number (factory default is 9876) and press the  key (or press the key labeled with the desired command directly). The display automatically retrieves the sub-menu display.

6.2.4 Returning to an earlier screen

To return to a previous screen at any time, press the  key. To return to the SYSTEM NORMAL display, press the  key repeatedly until you reach SYSTEM NORMAL. When you reach SYSTEM NORMAL, you cannot go any farther.

6.2.5 Entering data

When a sub-menu item asks you to enter data, enter the data and press the  key. If data already exists at a particular location, you can either accept that data or enter new data. When you press the  key to enter the data, the display returns you to the previous sub-menu display.

6.2.6 Drill

The  key activates all NACs and no relays. It creates a history log entry and, as an option, can be reported to the central station.

6.2.7 Disable

Use the  key to disable input points, outputs, or the dialer. When any device is disabled, the system shows this condition on the LCD and on the system trouble LED. The Disable All Inputs operation takes several seconds to perform, during which time the system display remains fixed.

6.2.8 History



Notice!

If a system without a Multiplex Expansion Module loses all power (AC and standby battery), then all history events are cleared.

The HISTORY option is a chronological list of system events that occurred. Press the  key to select HISTORY from the Main Menu (SYSTEM NORMAL display).



On an FACP with a Multiplex Expansion Module, up to 499 History events are supported.

On an FACP without a Multiplex Expansion Module, up to 99 History events are supported.

After you press the  key, the most recent system event appears on the top line of the LCD with the time and date below it.

Example: (Assume you pressed the  key at the Main Menu):

While the first event shows, the bottom line toggles every four seconds between the time and date that the event occurred.

To return to a previous screen in the history buffer, press . To scroll to the next event record, press .

For abbreviations used in history events, see the following table:

Abbreviation	Meaning		Abbreviation	Meaning
ALRM	Alarm		OFFNORM	Off Normal at Test
ARST	Alarm Restore		PH1	Phone Line 1
AUTOTST	Auto Test		PH2	Phone Line 2
BATT:LOW	Battery Low		RSTR	Restore
BAT:RSTR	Battery Restore		S	Supervisory
CPUFLT	Internal Error		SMK:FLT	Smoke Power Fault
DRILL:BEG	Drill Begin		SYSRESET	System Reset
DRILL:OVR	Drill Over		SYSRST	System Restore
DRST	Dirty Restore		SYSTRB	System Trouble
DRTY	Dirty		SYS:WDOG	Automatic CPU Reset (Watchdog)
DSBL	Disable		TRBL	Trouble
EE2	EEPROM		TRST	Trouble Restore
ENBL	Enable		TST:BEG	Test Begin
F	Fire		TST:OVR	Test Over
MANULTST	Manual Test		W	Waterflow

Tab. 6.12: History event abbreviations

For additional history log ID information, see the Modem IIIa² reporting table.

6.2.9 Remote Programming

Call for remote programming

Phone Numbers 1 and 3 must be programmed, along with Account Code 1. The control panel calls Phone Number 3 and attempts to connect to RPS. This function requires an access code with programming authority (Level 1).



Notice!

While programming is underway, the TROUBLE LED is on.

Answer for remote programming

The control panel immediately seizes the phone line to answer a remote programming call. While programming is underway, the Trouble LED is on. This also allows direct connection to RPS. This function requires an access code with programming authority (Level 1).



Notice!

UL requirement

The “answer for remote programming” function is not permitted by the current released edition of UL864.

6.3 Keypads

6.3.1 Built-in keypad

The keypad built into the control/communicator is an alphanumeric LCD keypad. It has a two-line by 16-character display to provide information on various control panel functions. Usually, the first line shows the off-normal condition, while the second line describes specific details that might be relevant to the existing system status. A built-in sounder annunciates keystroke entries and acts as a warning device.

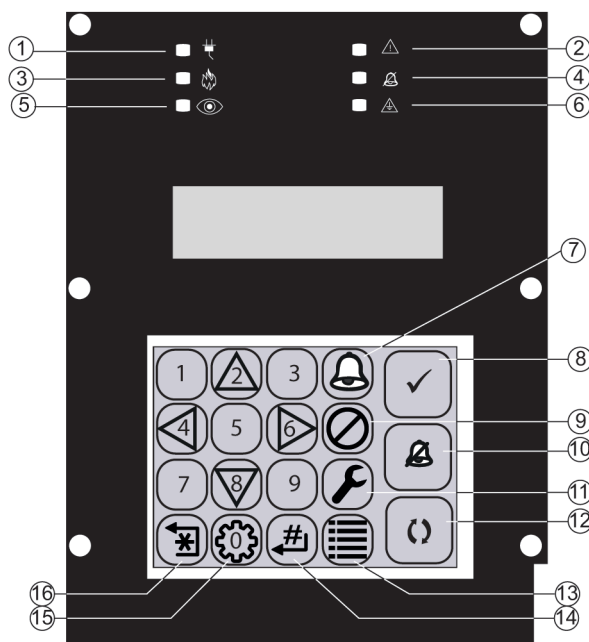

Figure 6.1: Built-in keypad

1	Green Power LED: is on when the AC power is present, and flashes when the unit is operating from battery power.	2	Yellow Trouble LED: lights when the system is faulted. The Trouble LED flashes while programming mode is active and whenever inputs are not active, such as during smoke power reset or alarm verification.
3	Red Alarm LED: lights when the system is in an alarm condition and has not been reset.	4	Yellow Silenced LED: lights when the user manually silences an event that is programmed as silencable; turns off when the condition that was silenced is corrected.
5	Yellow Supervisory LED: lights whenever the system is in a supervisory condition.	6	Yellow GND Fault LED: lights whenever the system detects a ground fault condition.
7	Drill key: used to activate the NACs manually. It creates a history log entry and, as an option, reports to the central station.	8	Acknowledge key: to silence local keypad sounders and to step through the groups of off-normal conditions.
9	Disable key: used to disable or re-enable inputs, NACs or relays (outputs), and the dialer	10	Silence key: mutes the bell or sirens for an alarm condition, if the system is so configured.
11	Test key: used to select one of seven special test modes. ¹	12	Reset key: briefly (programmable from 1 to 16 seconds) turns off power to the detectors to reset them and clears any off-normal conditions.
13	History key: to view system events.	14	Enter key: to accept data when in the programming mode.
15	0/Prog key: for selecting the programming mode.	16	Back key: used during programming to exit from menus or to exit from the programming mode entirely.
¹ For test modes, see <i>Testing</i> , page 52.			

For abbreviations on the keypad and control panel, see *Appendix B: Panel Displays*, page 111.

6.3.2

FMR-7033 keypad

The FMR-7033 Keypad is an alphanumeric LCD keypad. Up to four of these keypads can be mounted apart from the main control panel to provide additional locations for system status and control. The LCD display and keys operate identically to those of the built-in keypad on the control panel.

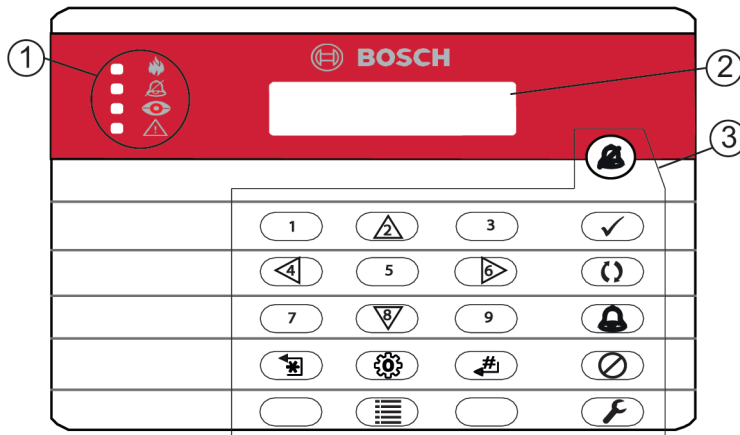

Figure 6.2: FMR-7033 keypad

1	LEDs	2	Keypad Display
3	Keys		

6.3.3 FMR-7036 Annunciator Keypad

The FMR-7036 is a four-wire LCD annunciator keypad used with the FPD-7024 to establish the location of a fire alarm. The two-line, 16-character display is capable of showing all messages normally displayed on the control panel. All alarm and status messages are included. Four on-board LEDs provide easy reading of the annunciator's status from a distance. There are Silence and Reset buttons for controlling annunciator and control panel operation. A built-in keyswitch offers extra security by locking the annunciator to prevent unwanted sounder silencing or control panel resetting.

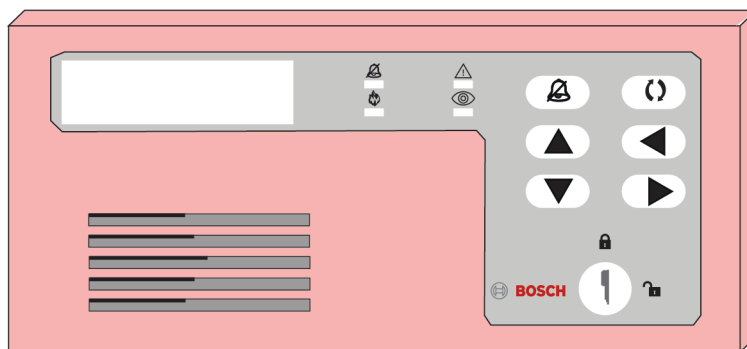

Figure 6.3: FMR-7036 Annunciator Keypad

6.4 Testing

6.4.1 Walk test

The Walk Test allows a technician to initiate each point manually to ensure that detectors connected to a point initiate a response at the control panel. While in this mode, the LCD shows the system test status and the sounder beeps every 10 seconds indicating trouble. NAC outputs activate during this test as points are alarmed and restored based on the following settings:

- NAC CONFIRM: 5 second activation
- SILENT: outputs do not activate

As each point is activated, the outputs activate once (if selected) and power is reset. As each point is activated, alarms and restorals are logged in the control panel's history log. When the point returns to standby, the outputs activate twice. The control panel attempts to reset points ten times to restore them. Points remaining alarmed when exiting from the walk test mode cause an immediate alarm.

6.4.2 Communicator test

The communicator sends a test report or reports according to the report steering programming. While communication is in progress, the Power LED flashes. When the communication succeeds, a long keypad beep sounds, the Power LED returns to normal, and the display returns to normal.

**Notice!**

This test is available only if your system sends alarms and system information to a monitoring service, and was programmed by the security installing company to permit communicator tests.

**Warning!**

Reset upon termination of test



Terminating the communicator test function (with the  key) resets the communicator and discards all unsent reports. When an off-normal condition occurs during a Communicator test, the test automatically resets, clearing all reports, so the off-normal conditions are sent normally.

6.4.3 Battery/NAC circuits test

**Notice!**

Fully charged batteries

The batteries must be fully charged before running this test to determine if they need to be replaced. To ensure the batteries are fully charged before beginning this test, make sure the system has been in normal operating mode for 48 hours.

In this test mode, the system operates the local NAC circuits to measure short-time discharge of the batteries. The test results (PASS [batteries are okay] or FAIL [batteries need to be replaced]) are shown at the end of the test, and are not reported to the central station. At the end of the test, you can press the  key to back out of the TEST mode, press the  key to return the display to standby mode, or allow the system to time out (return to standby mode) after three minutes.

6.4.4 Activate outputs test

This test turns a selected output on and off manually.

6.4.5 Input level test

This test shows the status of a selected on-board point. The loop existing through the point is shown. Normal loops show 11 mA to 15 mA. Loops in alarm show over 25 mA, and loops in trouble show less than 6 mA.

6.4.6

MUX test

This test allows activation of the special test mode for addressable (multiplex) devices. This applies only if the optional Multiplex Expansion Module is installed. When this test mode is selected, the system asks which bus to test, 1 or 2. There is only one bus, but on the I/O card, 1 corresponds to the terminals labelled A and 2 corresponds to the terminals labelled B. Select 1 to test points 9 to 128 and select 2 to test points 129 to 255. The system presents 5 options:

1. **List Devices:** Shows the point numbers of all devices on the selected bus. Some devices (such as a dual point module) can use two or more points
2. **List Holes:** Lists locations on the bus that have no assigned device. This can help to find programming errors or identify an available address for a new device.
3. **Show Extras:** The system scans the bus to identify devices that are present on the bus, but are not programmed into the system. Scanning the bus takes about 90 sec. and restoring the bus after scanning also takes about 90 sec. The system cannot identify devices above Address 128 on Bus 1, or below Address 129 on Bus 2. If you know that a device is connected to the system but cannot find it, ensure that it is connected to the correct bus: 9 to 128 for Bus 1, 129 to 255 for Bus 2.
4. **Show Missing:** Lists devices programmed into the system but not present on the bus are listed. Unless a device was programmed into the system (such as using MUX EDIT), it is not considered missing.
5. **Show Status:** After you select a device and press the  key, this test shows detailed status information for the selected device. Eight conditions (not all status conditions apply to or are supported by all devices) are shown. See the display shown below (which updates automatically every five seconds). For this option, you can view the status of any MUX device regardless of which bus you selected to test when test mode was entered.

-XxLxRx DxMxTx FxAx

The x is either 0 or 1 depending on whether the condition is false or true (0=false and 1=true). The letters indicate the condition.



- X: Reserved for future use.
- L: Commanded relay state - this is how the output relay should be set.
- R: Actual relay state - this is how the output relay is actually set.
- D: Detector dirty - the detector is excessively sensitive.
- M: Missing device - the device cannot be found on the loop. Unless a device was programmed into the system (such as using MUX EDIT), it is not considered missing.
- T: Tamper - the detector's case was opened.
- F: Loop fault - the loop from a contact input device is open, or the device is faulted.
- A: Loop alarm - the point is in alarm.

Pressing the  ends the display for any of these modes.

Examples: XOLORODOMOTOFOA0 (relay off, not dirty, not missing, no tamper, no fault and no alarm).

6.4.7

Sensitivity test

Tests the MUX smoke detectors to determine if they are within their normal range of sensitivity. Press the  key, then .

6.5 Point/Zone Mapping

The control panel supports a flexible system to map input points to output points. The system defaults so that all NAC outputs are activated by a fire alarm. By programming output zones, you can create almost any output activation scheme, such as “floor above and floor below” activation or conditional elevator recall.

Input points: Smoke detectors, pull stations, and so on.

Zone: A group of input points (Zones 1 to 50 are configurable, 52 to 63 are activated automatically).

Output points: NACs such as bells, strobes, and relays. Inputs activate zones, and zones activate outputs.

Zones 1 to 50 are available for the installer to program. Each input can activate one zone; however, any number of inputs can be mapped to the same zone.

Zones above 50 are automatically activated by inputs. For example, any input that is configured as a waterflow type activates Zone 61 when it is alarmed. Any output driven by Zone 61 activates when any waterflow type point is alarmed.



Notice!

Do not set Zone 62 for NACs or RNACs.

Configuring a local NAC or RNAC with Zone 62 causes communication fail trouble to be automatically restored when it should remain latched until the condition causing the failure is corrected.

Up to 64 zones can be assigned. The installer can assign Zones 1 to 50. Zones 51 to 63 are hard-coded to pre-assigned conditions.

For how inputs control zones and zones control outputs, see the following figure:

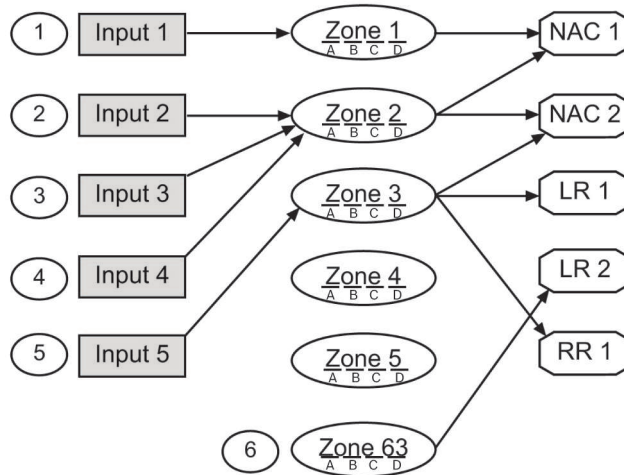

Figure 6.4: Mapping inputs, zones, and outputs

1	Input Point 1 is assigned to Zone 1, mapped to NAC Point 1.	4	Input Point 4 is assigned to Zone 2, mapped to NACs 1 and 2.
2	Input Point 2 is assigned to Zone 2, mapped to NACs 1 and 2.	5	Input Point 5 is assigned to Zone 3, mapped to NAC 2, LR 1 and RR1.
3	Input Point 3 is assigned to Zone 2, mapped to NACs 1 and 2.	6	General Alarm Zone 63 drives LR 2.

For pre-assigned zone assignments, see the following table:

Zone	Condition
51	Reserved for future use.
52	General Fire Alarm (non-silenceable); same as Zone 53, but remains active even while system is silenced.
53	General Fire Alarm (silenceable); active when a fire alarm condition is present; does not activate for waterflow.
54	(reserved)
55	General Supervisory (silenceable)
56	General Waterflow (silenceable)
57	Communication Trouble; active when the dialer fails to communicate; remains active until communication through the digital communicator is restored.
58	General Supervisory Alarm (non-silenceable); active when any supervisory alarm condition is present.
59	Alarm Verification; active while alarm verification is in progress. This starts with the first detection of an alarm to be verified and clears in 1 to 16 seconds according to the configuration of reset time or when the system is reset.
60	Active when AC power fails.
61	General Waterflow (Non-silenceable); active when any waterflow alarm is present.
62	General Trouble. Active while any system trouble is present, not active in test and programming modes.
63	General Alarm, Supervisory, and Waterflow (non-silenceable); active while any alarm is present; remains active even while system is silenced.
64	(reserved)

Tab. 6.13: Pre-assigned zones

6.6

Personal Identification Numbers (PINs)

The personal identification number (PIN) is the four digit code users enter at the keypad to gain access to the system. A PIN can be assigned to each User Number. The User Number identifies each person using the system. There are 16 possible User Numbers (00 to 15). User codes 00 to 99 are available with the installation of an FPE-7039 or D7039 Multiple Expansion Module. The Authority Level assigned to each User Number determines which functions each user can perform.

Your system can have up to 100 different PINs, each four digits long. There is one PIN for each User Number. Attempting to assign the same PIN to multiple User Numbers results in the three-beep error tone, and the change is not made.

User Number 00 is designated as a Programmer's Code. It can be used to silence alarms, reset, disable, and program the unit.

User Number 00 is shipped from the factory with the sequence of 9876. Change this code to one of your personal preference. It is automatically assigned the highest authority. Never program PINs with common sequences such as 1111, 1234, or 2468 because they are easily violated.

Authority levels are assigned to PINs to determine which functions each user can perform. For a description of the four authority levels, see the following table:

PIN authority level	Allowed operations
Maximum (1)	All control panel operations; including programming and disable
Medium (2)	System test modes, fire drill, reset, silence, view history
Minimum (3)	Silence, view history
None (0)	Allows no action

Tab. 6.14: PIN authority levels

6.7 Communicator Operation

The FACP contains an integrated communicator that can be optionally enabled to send reports to a monitoring station. When enabled, operation of the communicator is fully automatic.



Notice!

You must enable and configure the communicator before it works. The communicator and phone line monitors are disabled in the default factory configuration.



Notice!

To disable a phone number or IP address, set the FORMAT to 0=disable. To completely disable the communicator, set FORMAT to 0=disable for both phone numbers/IP addresses, and set MONITOR to 0=NO for both phone lines.



Notice!

Do not install this control panel on a phone line that might be required for other emergency use.

When events occur, the communicator sends them to the monitoring station in priority order according to NFPA requirements. Fire and waterflow alarms are sent first, followed by supervisory alarms and trouble reports and then all other reports. Priority reporting can send a Restoral report after several alarm reports in a situation where a point sends multiple alarms, implying that a point is restored when it has returned to alarm. The following sequence, (alarm, restore, alarm) is sent as (alarm, alarm, restore) when priority sorting is applied.



Warning!

Event sorting can hide unrestored points
Priority sorting on events sent to a monitoring station can cause the message sequence to imply that a point is restored when it is not.

The communicator can store 32 events while waiting for the monitoring station to accept the events. If more than 32 reportable events occur before the monitoring station accepts events, then some event information is lost and a COMM FAIL trouble report is sent to the central station.

The FACP's communicator is equipped with a line-seizure relay to prevent interference with outgoing event reports. In a system where the fire communicator shares the phone line with other equipment on the premises, the phone line might be unavailable to the other equipment for up to 15 minutes. Other equipment can be installed on the same phone lines as the fire control panel as long as it is **not** installed between the fire panel and the phone lines.

7 Programming overview



Danger!

Untested systems!

After any programming change, and especially after remote programming changes, completely check the operation of the control panel. Hazards to life and property can result if the system is not tested to detect possible improper programming.



Warning!

Improper system operation!

When programming the system, enter only valid types of information within the ranges specified in the programming table. Incorrect programming results in improper system operation. When using built-in programming, invalid input values might not be rejected in every case. Ensure that you enter only the intended values while programming to prevent improper system operation.

7.1 Programming features

For programming requirements for the current released edition of UL864, see the following table:

Program feature or option	Permitted in UL864 (Yes/No)	Possible settings	Settings permitted in UL864
Auto Test Frequency	Yes	4 HOURS 6 HOURS 24 HOURS 7 DAYS 28 DAYS	4 HOURS 6 HOURS
AC Fail Delay	Yes	Wait for DC Wait Delay Time 0-24 HRS	Wait Delay Time 1-3 HRS
Phone Line Monitor for Each Line	Yes	No Yes	Yes
Remote Programming (offsite)	Yes	PHONE/IP #1 PHONE/IP #2 COMPTER PH/ID	Phone #1 Phone #2
Response Time	Yes	Fast (.5 sec) Programmed	1 sec
NAC Config	Yes	Steady Pulsing California March Temporal Wheelock Gentex System Sensor	Temporal Wheelock Gentex System Sensor

Program feature or option	Permitted in UL864 (Yes/No)	Possible settings	Settings permitted in UL864
Alarm/Trouble Open Status	Yes	1) Alarm 2) Trouble	2) Trouble
Latching	Yes	1) Yes 2) No	1) Yes for Alarms
PIN Required on Remote Keypad	Yes	0) No 1) Yes	1) Yes
NAC Silence Mode	Yes	1) Audible only 2) Audi & Visi	2) Audi & Visi

Tab. 7.15: Programming features for UL864

7.2 Point programming

Each of the points in the system can be programmed with its own characteristics. Point functions simplify the programming of points by allowing you to define a common set of characteristics for similar points, and assigning those characteristics to selected points as a point function. There are 16 point functions, each of which has programmable features for configuration (fire, waterflow, and so on), local only operation, silencing, and loop response. Each point is assigned to use the characteristics of one point function, and then is individually programmed for additional characteristics: response to an open circuit, enabled status, output zone, verification, latching and point description.

Before programming the control panel, determine the types of functions that are needed, and then map the various input points to the functions. For example, you might determine that you have the following functions:

- 1 = Pull Station
- 2 = Smoke Detector
- 3 = Reset Keyswitch
- 4 = Silence Keyswitch
- 5 = Supervisory Input
- 6 = Local Test
- 7 = Waterflow Sensor

For the characteristics that correlate with each function, see the following table. For default point function information, see *Appendix D: Programming Defaults List, page 121*.

Function	Configuration	Local only?	Silenceable?	Loop response
1. Pull Station	Fire	No	No	Fast
2. Smoke Detector	Fire	No	No	Fast
3. Reset Keyswitch	Reset	Yes	No	Fast
4. Silence Keyswitch	Silence	Yes	No	Fast
5. Supervisory Input	Supervisory	No	Yes	Fast

Function	Configuration	Local only?	Silenceable?	Loop response
6. Local Test	Fire	Yes	Yes	Fast
7. Waterflow Sensor	Waterflow	No	No	Programmed

Tab. 7.16: Point function characteristics

7.3

Alpha programming

When programming the point descriptions, the numeric keys are used to enter alphanumeric information similar to the way telephone keys are used to process information over the phone lines each key represents four or more letters or symbols. For alphanumeric point programming, see the following table:



Notice!

A different character is entered each time a numeric key is pressed. For example, pressing  repeatedly enters A, B, C, 2, A, B, and so on.

Key	Values									
1	SPACE	1	,	'	&	/	#	!	- ¹	
2	A		B		C		2 ²			
3	D		E		F		3 ²			
4	G		H		I		4 ²			
5	J		K		L		5 ²			
6	M		N		O		6 ²			
7	P		R		S		7 ²			
8	T		U		V		8 ²			
9	W		X		Y		9 ²			
0	Q		Z		0					
#	Enters the description and returns to the Programming Menu.									
*	Returns to the Programming Menu without entering changes.									
🔔	Moves the cursor one space to the right.									
🚫	Moves the cursor one space to the left.									
¹ Press the 1 key nine times to display the – symbol. ² Press the listed key four times to display this value.										

Figure 7.1: Programming Points using alphanumerics

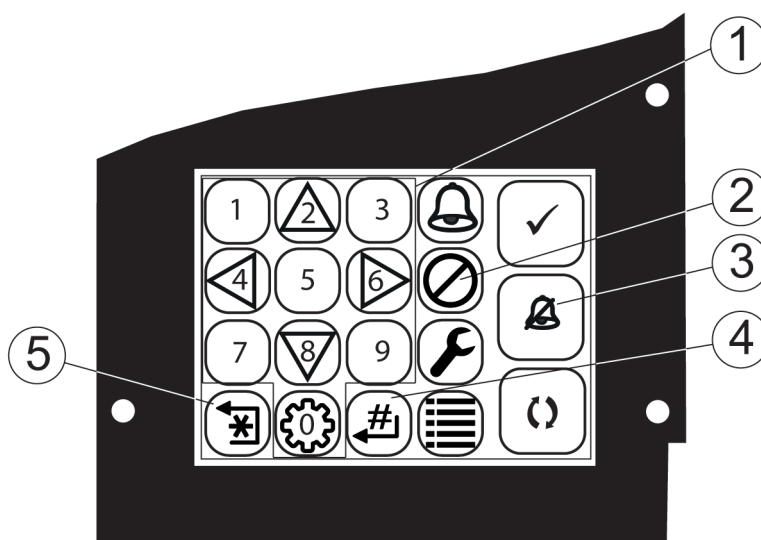

Figure 7.2: Essential keys for alphanumeric programming

1	Number keys (including 0): used to enter alphanumeric values.	2	(Disable) key: moves the cursor one space to the left
3	(Silence) key: moves the cursor one space to the right.	4	(Enter) key: used to accept data when in programming mode.
5	(Back) key: used to exit alpha programming, or exit the programming mode entirely.		

7.4 Format programming

4/2

The 4/2 format supports only a four-digit account number. The control panel sends the low order four digits that are programmed (program: 0000001234; panel sends: 1234). When 4/2 format is used, reports generated by points consist of an event type (first digit) and a point number (second digit). Digits can be programmed for the following events: fire alarm, fire restoral, waterflow alarm, supervisory alarm, point trouble, trouble restore, point disable, disable restoral, and monitor alarm. The same event type (first digit) is sent for any point. The point number is the second digit. Each point can be programmed to a different digit.

7- PROG FORMATS, 1- 4/2 POINT RPT.

Additionally, 18 system events can each be programmed with a unique two-digit code. Events that can be programmed this way include, for example: System Silence, Fire Drill, Phone 1 Trouble, and Phone 2 Restoral.

7- PROG FORMATS, 2- 4/2 RPT CODS.

The 4/2 (and 3/1) format cannot report full point data for each point. Points 1 to 10 have unique reporting codes. The codes repeat every ten points. For example, Point 31 has the same point report as Points 11 and 21.

BFSK

Similar to the programming of system events for 4/2 formats, five system events can be programmed for two unique digits each when the BFSK format is used. This programming is done under:

7- PROG FORMATS, 3- BFSK RPT CODS.

The BFSK format supports only a three-digit account number. The control panel sends the 7th to 9th digits that are programmed (for example, 1234567890, account number sent is 789). The BFSK format requires that an A (hex character) be entered at the control panel to cause the receiver to display 0. The BFSK format can report only eight points, so Points 8 to 255 are all reported as point “8”.

3/1

The 3/1 reporting codes are determined by the programming of the 4/2 codes. Send only Digit 1 (left digit of the two-digit code) and the 7th to 9th digits of the account number (for example, 1234567890, account number sent is 789).

SIA

The SIA format supports low order six-digit account numbers. For SIA format, if 1-4 digits are entered it will ignore the leading zeros and the panel will send 4 digits, if 5 or 6 digits are entered it will send this number of digits to the central station. The SIA reports are fixed, and do not require programming.

Contact ID

The Contact ID format supports a ten-digit account number. if 1-4 digits are enter the leading zeros are ignored and the panel will send 4 digits, when the account number is 5-10 digits the panel will send 10 digits to the central station. The Contact ID reports are fixed and do not require programming.

Modem IIIa²

The format supports a 10-digit account number. If 1-4 digits are entered, the leading zeros are ignored and the panel will send 4 digits; when the account number is 5-10 digits, the panel will send 10 digits to the central station. The reports are fixed and do not require programming.

**Notice!**

When Anti-replay is enabled in IP reporting, the receiver account number uses the low order 8 digits of the panel account number as NNC (network naming convention).

7.5 Program menu tree

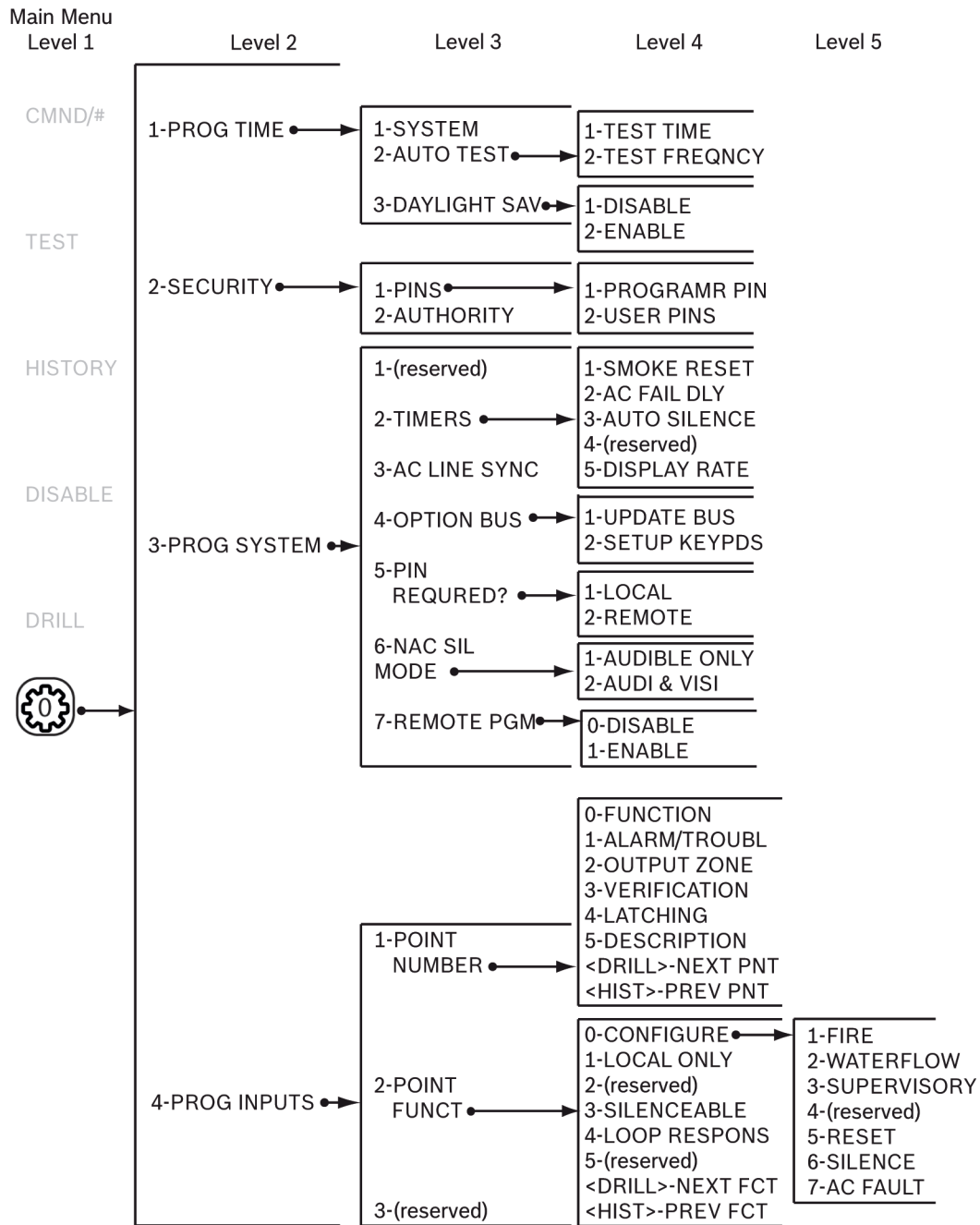

Figure 7.3: Program Menu - page 1

For factory defaults, see Appendix D.

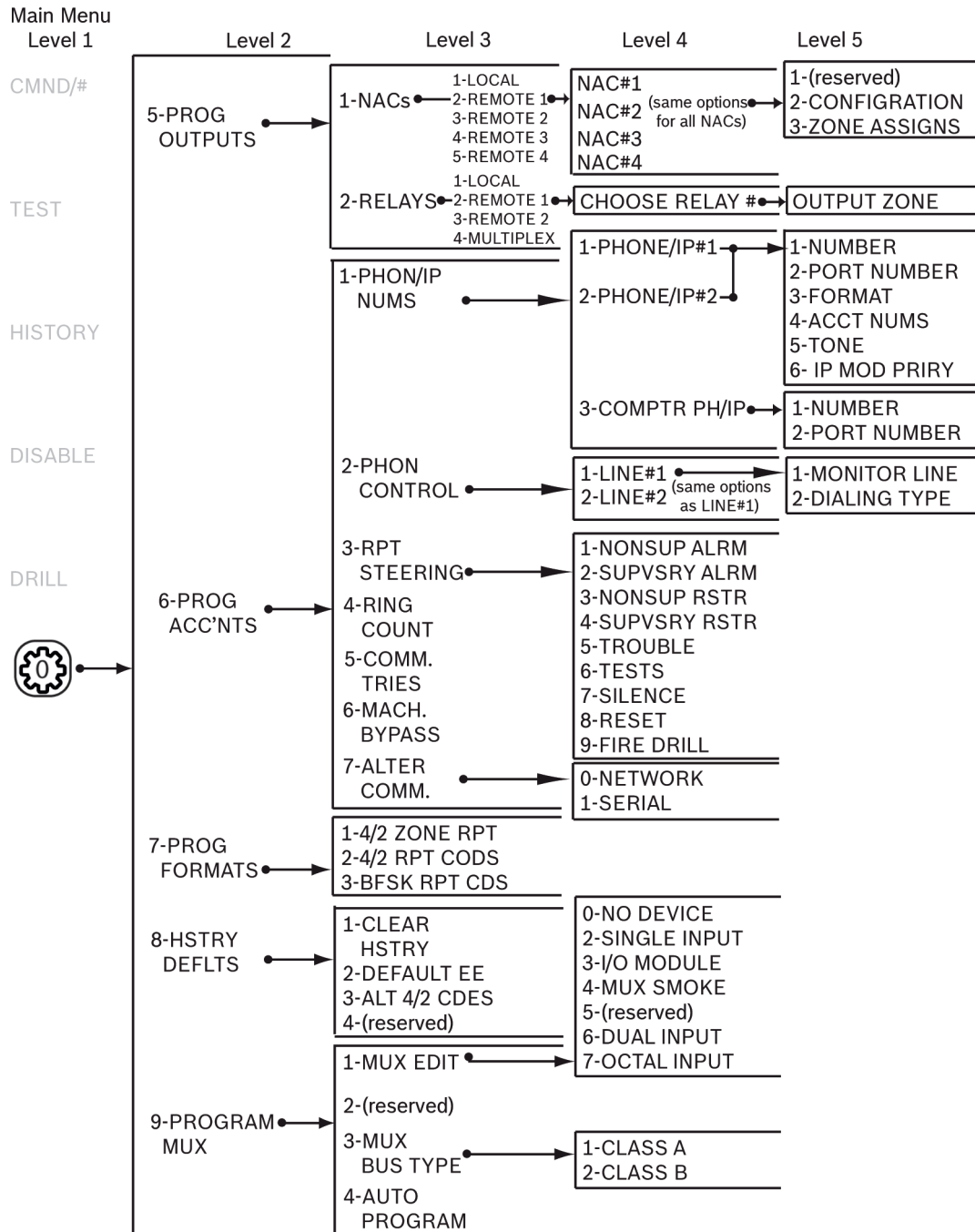

Figure 7.4: Program Menu - page 2

For factory defaults, see Appendix D.

See also

- Appendix D: Programming Defaults List, page 121

7.6

Shortcuts

You can use shortcuts to reduce repetition and provide speedy instructions for programming the control panel.

The first level in the system is the Main Menu. For all system programming,  is your Main Menu choice. Therefore, the first number in the shortcut is “0”.

The second level in your system provides eight options: PROG TIME, SECURITY, PROG SYSTEM, PROG INPUTS, PROG OUTPUTS, PROG ACCOUNTS, PROG FORMATS, and HISTORY DEFAULTS. When a Multiplex Expansion Module is installed, a ninth option appears: PROGRAM MUX. The second number in the shortcut enters the Level 2 option and allows access to Level 3.

Level 3 provides the third set of options that branch from Level 2. The third number in the shortcut represents the option chosen in Level 3.

For an example of the shortcut to TEST FREQNCY and TEST TIME, see the following figure. The sample of the Program Menu Tree shows that to get to TEST TIME and TEST FREQNCY, you must go to PROG/0 in Level 1, PROG TIME in Level 2, and AUTO TEST in Level 3. The shortcut is simply a list of the keys you press to get to the fourth level option. Once you enter the shortcut, follow the procedural description that appears on the screen of the specific function you are programming.

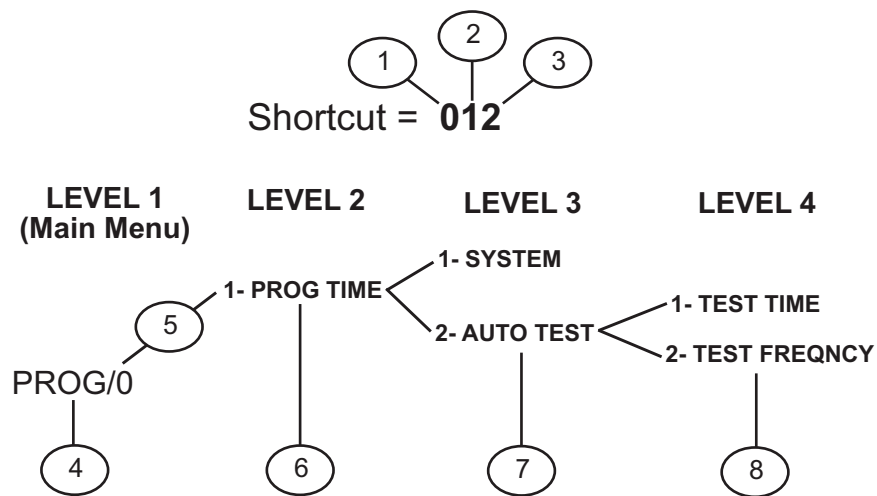

Figure 7.5: Example of a programming shortcut

1	Use "0" to select PROG from the Main Menu which scrolls at the System Normal display.	2	Use "1" to select PROG TIME from Sub-Level 2.
3	Use "2" to select AUTO TEST from Sub-Level 3. Follow the procedural description that appears on the screen.	4	First number in shortcut
5	Password	6	Second number in shortcut
7	Third number in shortcut	8	Fourth number in shortcut

7.7 Remote programming

When using a modem for remote programming, the system operates during remote programming so that new alarms end the remote programming session and report normally. Using the keypads to perform other functions during remote programming (such as disables) can cause remote programming to disconnect or other unexpected operations. Avoid downloading programming changes that cause alarms, because the session disconnects as soon as the alarm occurs, before the session completes. To indicate that the system is in a special operating mode with user input inhibited (but alarm monitoring continuing), the

system indicates SYSTEM TROUB, RMT PRG ACTIVE during remote programming. Sounders do not activate during this mode, but other outputs programmed for Zone 62, general system trouble, do activate.

Trouble conditions that occur during a remote programming session are not annunciated at the control panel until the remote programming session ends. These conditions are available in the remote programmer diagnostic displays during the session. Alarm conditions terminate remote programming and are shown immediately.

**Notice!**

After using RPS for remote programming, cycle power to the panel to bring the system to normal.

When remote programming is disabled, you can still connect to the control panel for diagnostics and view the existing programming (except PIN numbers). To actually change programming, enable remote programming.

To enable remote programming, refer to the following programming items:

- 0-3-7 *Remote programming, page 77*
- 0-6-1 *Phone Numbers/IP Addresses, page 88*
- 0-6-2 *Phone Control, page 94*
- 0-6-4 *Ring Count, page 96*
- 0-6-6 *Machine Bypass, page 97*

An access code with maximum authority (1) is needed to begin remote programming from the panel.

8 Control panel programming

When you logon to the control panel, the following screen appears prompting you to choose the display language:

```

LANGUAGE
1-ENGLISH
2-ESPANOL
3- PORTGUES

```

If you want English or if you have previously selected a language different than English, then you can let the screen time out and it will set the display for the default (English) or leave it set to the language chosen previously.

Main Menu:

```

SYSTEM NORMAL
SELECT: PROG/0
SELECT: ENTER/#
SELECT: TEST
SELECT: HISTORY
SELECT: DISABLE
SELECT: DRILL

```

Programming Menu:

```

PROG/0
1-PROG TIME
2-SECURITY
3-PROG SYSTEM
4-PROG INPUTS
5-PROG OUTPUTS
6-PROG ACC'NTS
7-PROG FORMATS
8-HISTORY DEFLTS
9-PROGRAM MUX

```

8.1 PROG TIME

```

PROG TIME
1-SYSTEM
2-AUTO TEST
3-DAYLIGHT SAV

```

8.1.1 Program time

```

Shortcut: 0-PROG, 1-PROG TIME, 1-SYSTEM

```

The following window appears:

```

ENTER DATEMMDDYY: _____

```

Enter the date followed by the  key. The following window appears:

```

ENTER TIMEHHMM: _____

```

Enter the time followed by the  key.

8.1.2 Automatic test

Test Time

Shortcut: 0-**PROG**, 1-**PROG TIME**, 2-**AUTO TEST**

Use this feature to program the time of day at which automatic tests occur. This feature uses a 24-hour clock (for example, 11:00 p.m. = 2300).

The following window appears:

```
AUTOMATIC TEST
1-TEST TIME
2-TEST FREQNCY
```

Press **1** to select Test Time. The following window appears:

```
AUTO TEST TIMEHHMM: _____
```

Enter the time followed by the **ENT** key.

Test Frequency

Shortcut: 0-**PROG**, 1-**PROG TIME**, 2-**AUTO TEST**

This feature allows you to program how often the automatic test reports are sent. The first test is sent when the programmed test time matches the system time. Subsequent reports are sent according to the selected interval.

The following window appears:

```
AUTOMATIC TEST
1-TEST TIME
2-TEST FREQNCY
```

Press **2** to select Test Frequency.

The following window appears:

```
AUTO FRQNCY ( )
1-4 HOURS
2-6 HOURS
3-24 HOURS
4-7 DAYS*
5-28 DAYS*
```

* For acceptable programming selections for Listed applications that meet the requirements of the currently released edition of UL864, see *Programming features, page 59*.

Press the number key that corresponds to your selection. The existing setting is displayed in parentheses on the first line. After you have programmed the test frequency, the previous window appears.

8.1.3 Daylight saving time

Shortcut: 0-**PROG**, 1-**PROG TIME**, 3-**DAYLIGHT SAV**

This feature enables automatic adjustment of system time for Daylight Saving Time. The dates for the adjustment are pre-programmed in the system.

The following window appears:

```

DAYLIGHT
1-DISABLE
2-ENABLE

```

Press **1** to select DISABLE or **2** to select ENABLE. After you have programmed this feature, the previous window appears.

8.2 SECURITY

```

SECURITY
1-PINS
2-AUTHORITY

```

8.2.1 Personal Identification Numbers (PINs)

Programmer PIN

```

Shortcut: 0-PROG, 2-SECURITY, 1-PINS

```

The Programmer PIN is the code used by the installer to configure and operate the panel. Factory default code is 9876 and may be changed at any time.



Notice!

Do not set Programmer PIN to 0000.

The Programmer PIN can be set from 0001 to 9999. Setting the Programmer PIN to 0000 will prevent future login for programming.

The following window appears:

```

PROGRAM PINS
1-PROGRAMR PIN
2-USER PINS

```

Press **1** for Programmer PIN. The following window appears:

```

USER 0
ENTER PIN:_____

```

Enter the PIN and press the **2** key. After you have programmed the Programmer PIN, the previous window appears.

Program User PINs

```

Shortcut: 0-PROG, 2-SECURITY, 1-PINS

```

Up to 15 additional user codes (or up to 99 additional users when a Multiplex Expansion Module is installed) can be programmed to protect the system from unauthorized operation and allow a record to be kept of actions by individual system users.

The following window appears:

```

PROGRAM PINS
1 - PROGRAMR PIN
2 - USER PINS



```

Press **2** for user PINs. The following window appears:

```

OTHER PINS
USER (01-15)

```

Enter the user for whom you want to program a PIN and press the  key. Example: For User 5, press . The following window appears:

```

USER 5
ENTER PIN:_____
    
```

Enter the PIN and press the  key. After you have programmed the user PIN, the previous window appears.

8.2.2

Authority

Shortcut: 0-**PROG**, 2-**SECURITY**, 2-**AUTHORITY**

This feature determines which system actions a user can perform.

For PIN authority levels, see the following table:

PIN Authority Level	Allowed Operations
None (0)	Allows no action
Maximum (1)	All control panel operations, including programming and disable.
Medium (2)	System test modes, fire drill, reset, silence, view history.
Minimum (3)	Silence, view history.

Tab. 8.17: PIN authority levels

The following window appears:

```

AUTHORITY
USER (01 - 15)
    
```

Enter the user for whom you want to program the authority level and press the  key. The following window appears and scrolls through the following choices:

```

USER 1 ATHRY (_____)
0- NONE
1- MAXIMUM
2- MEDIUM
3- MINIMUM
    
```

Press the number key that corresponds to your selection. The existing setting is shown in parentheses on the first line. After you have programmed the user authority, the previous window appears.

8.3

PROG SYSTEM

- PROG SYSTEM
- 1- (reserved)
- 2-TIMERS
- 3- AC LINE SYNC
- 4- OPTION BUS
- 5- PIN REQUIRED?
- 6- NAC SIL MODE
- 7- REMOTE PGM

8.3.1

Program timers

Shortcut: 0-**PROG**, 3-**PROG SYSTEM**, 2-**TIMERS**

The following window appears:

TIMERS
 1 - SMOKE RESET
 2 - AC FAIL DLY
 3 - AUTO SILENCE
 4 - (reserved)
 5 - DISPLAY RATE

Smoke reset

Shortcut: 0-**PROG**, 3-**PROG SYSTEM**, 2-**TIMERS**

This feature determines how long the smoke detector power (SMK) is off after reset. No alarms are registered by the system for 5 sec after power is returned.

The display scrolls through the TIMERS options. Press  for Smoke Reset. The following window appears:

SMOKE RESET (_)
 (1-16 SECS): _____

Enter the time and press the  key. The existing setting is shown in parentheses on the first line. After you have programmed the smoke reset, the previous window appears.

AC fail delay

Shortcut: 0-**PROG**, 3-**PROG SYSTEM**, 2-**TIMERS**

This feature sets the number of hours the control panel waits after an AC failure before sending an AC Failure report. A setting of DC causes the system to send a report when 25% of the battery capacity is used.

The display scrolls through the TIMERS options. Press  for AC FAIL DELAY. The following window appears:

AC FAIL DELAY
 1 - WAIT FOR DC
 2 - ENTER TIME

The wait for DC function causes the AC fail report to be sent when the battery is 25% depleted, based on the measured voltage of the battery. If you want to WAIT FOR DC (25 percent of capacity), then press the  key. The existing setting is displayed in parentheses on the first line, either “DC”, or the number of hours selected. After you program the AC Fail Delay, the previous window appears.

To ENTER TIME press . The following window appears:

AC FAIL DLY (__)
 (00-24 HRS): _____ *

* For acceptable programming selections for Listed applications that meet the requirements of the currently released edition of UL864, see *Programming features*, page 59.

Enter the time and press . The existing setting is shown in parentheses on the first line. After you program the AC Fail Delay, the previous window appears.



Notice!

When Wait For DC is the existing selection, the Enter Time menu displays DC as the time in hours.

Auto silence

Shortcut: 0-**PROG**, 3-**PROG SYSTEM**, 2-**TIMERS**

This feature silences the sounding of an alarm condition on selected NACs after a certain amount of time. When you use Auto Silence, pressing disables the feature and the only way to turn off an alarm is to manually silence it. Entering between 5 min and 99 min means that the alarm sounds for that much time before automatically silencing.



Notice!

If the condition that caused an alarm is not corrected after an alarm is silenced (automatically or manually), then the alarm sounds again within 24 hours. The system must eventually be reset after silencing to allow the alarmed zones to restore and detect new alarms.

The display scrolls through the TIMERS options. Press for AUTO SILENCE. The following window appears:

AUTO SILENCE (__)
(0, 5-99 MIN): _____ *

Enter desired length of time (or press to disable) and press the key. The existing setting is shown in parentheses on the first line. After you program the auto silence, the previous window appears.

Display rate

Shortcut: 0-**PROG**, 3-**PROG SYSTEM**, 2-**TIMERS**

Set the speed at which menus are displayed on the LCD (in units of 0.25 sec). The display scrolls through the TIMERS options. Press for DISPLAY RATE. The following window appears:

DSPLY RATE (__)
.25 X (1-16): _____ *

Enter desired value and press . The existing setting is shown in parentheses on the first line. After you program the display rate, the previous window appears.

8.3.2

AC line synch

Shortcut: 0-**PROG**, 3-**PROG SYSTEM**, 3-**AC LINE SYNC**

When AC power is available, the control panel uses the line frequency to stabilize the real-time clock. This setting must match the frequency of the local AC power (60 Hz in the US). The following window appears:

AC LINE SYN (__)
1 - 50 Hz
2 - 60 Hz

Press the number key that corresponds to your selection and press . The existing setting is shown in parentheses on the first line. After you program AC Line Synch, the previous window appears.



Notice!

AC line synch setting reprogrammed

In order to keep the real-time clock operating correctly, cycle power to the panel to restore the system to normal after reprogramming the AC line synch setting.

8.3.3

Option bus

Update bus

Shortcut: 0-**PROG**, 3-**PROG SYSTEM**, 4-**OPTION BUS**

When devices are added or removed from the option bus, this feature queries the option bus and updates the list of connected devices. This enables the new devices and removes supervision for devices no longer present.



Warning!

Inoperable, unsupervised devices!

Be sure the count of devices displayed when this operation completes matches the number of devices installed on the bus. Devices not detected during the update bus operation will not operate and will not be supervised.



Notice!

These menu items are allowed only at the local keypad.

The following window appears:

OPTION BUS (M/M)
1 - UPDATE BUS
2 - SETUP KEYPDS

Press  to program the system to update the bus. After you program Update Bus, the following window appears:

UPDATE COMPLETE
TOT BUS DEVS: X

Then the previous window appears.

Setup keypads

Shortcut: 0-**PROG**, 3-**PROG SYSTEM**, 4-**OPTION BUS**

This feature tells the system how many keypads to supervise. It automatically performs an update bus operation as it completes.

```
OPTION BUS
1 - UPDATE BUS
2 - SETUP KEYPDS
```

Press **▲** to set up keypads. The following window appears:

```
# OF KEYPADS ( )
(0-4): _____
```

Enter the desired value and press **▶**. The existing setting is shown in parentheses on the first line. After you set up the keypads, the update bus operation proceeds, then the previous window appears.

8.3.4

PIN required

Local

```
Shortcut: 0-PROG, 3-PROG SYSTEM, 5-PIN REQUIRED?
```

A PIN can be required before performing operations. Enter the PIN at the local or built-in keypad.

The following window appears:

```
PIN REQUIRED?
1- LOCAL
2- REMOTE
```

Press **1** to require a PIN at the local keypad. The following window appears:

```
LOCAL KEYPD PIN?
_____: YES(1) NO(0)
```

Press the number key that corresponds to your selection. The existing setting is shown in front of the colon on the second line. After making your selection, the previous window appears.

Remote

```
Shortcut: 0-PROG, 3-PROG SYSTEM, 5-PIN REQUIRED?
```

The following window appears:

```
PIN REQUIRED?
1- LOCAL
2- REMOTE
```

Press **▲** to select remote PIN. The following window appears:

```
REMOTE KYPD PIN?
_____: YES (1) NO (0)
```

Press the number key that corresponds to your selection and press **▶**. The existing setting is shown in front of the colon on the second line. After you select the PIN requirement, the previous window appears.

For acceptable programming selections for Listed applications that meet the requirements of the currently released edition of UL864, see *Programming features*, page 59.



Notice!

A PIN can be required before operations can be performed using the remote keypads on the option bus. If the remote keypads are not otherwise secured, then this option must be set to YES to comply with NFPA and Local requirements.

8.3.5

NAC silence mode

Shortcut: 0-**PROG**, 3-**PROG SYSTEM**, 6-**NAC SIL MODE**

NAC silence mode allows notification devices to be silenced from the control panel. Any output configured as silenceable is silenced upon silence operation. You can define audible only or audible and visible by this option. When silenced, a relay is completely turned off. The following window appears:

1-AUDIBLE ONLY
2-AUDI & VISI

Press **1** to configure the audible output to be silenceable leaving the visible output to display. Press **2** to configure both the audible and visible outputs to be silenceable.

8.3.6

Remote programming

Shortcut: 0-**PROG**, 3-**PROG SYSTEM**, 7-**REMOTE PGM**

Remote Programming Software (RPS) allows connection to the panel from a remote site to reconfigure any of the programmable options. When remote programming is disabled, you can still connect to the control panel for diagnostics and to view the existing program. PIN numbers are suppressed while remote programming is disabled.

REMOTE PGM
0- DISABLE
1- ENABLE

Press **0** to select DISABLE or **1** to select ENABLE, and the previous window appears.



Danger!

After any programming change, and especially after remote program changes, completely check operation of the control units. Hazards to life and property can result if the system is not tested for incorrect programming.

8.4

PROG INPUTS

PROG INPUTS
1- POINT NUMBER
2- POINT FUNCT
3- (reserved)



Notice!

Point functions allow quick programming of similarly functioning points (for example, pull stations, smoke detectors) with common settings.

For more information on point functions, see *Point function*, page 81.

8.4.1

Point number

Shortcut: 0-PROG, 4-PROG INPUTS, 1-POINT NUMBER



The following window appears:



POINT NUMBER (1-255): ____

Enter the point number you wish to program and press . Once you have entered the point number, the display scrolls through the following PROG INPUT options:

PROG POINT
0- FUNCTION
1- ALARM/TROUBL
2- OUTPUT ZONE
3- VERIFICATION
4- LATCHING
5- DESCRIPTION
<DRILL>-NEXT PNT
<HIST>-PREV PNT

Press the number key that corresponds to your selection.

Pressing  retrieves the next point. For instance, if you are programming Point 2 and you press , then you retrieve the setting for Point 3.

Pressing  retrieves the previous point. For instance, if you are programming Point 2 and you press , then you return to the setting for Point 1.

Assigning point functions

Shortcut: 0-PROG, 4-PROG INPUTS, 1-POINT NUMBER

This feature assigns each point to one point function. A point function is a set of characteristics that you can assign to selected points. There are 16 point functions to choose from.

For more information about point functions, see *Point function*, page 81. For the limitations when assigning points to point functions that were programmed with a response time other than Fast, see Loop response in *Point function*, page 81.

Enter the point number you wish to program and press . The display scrolls through the PROG INPUT options.

Press  to select FUNCTION. The following window appears:

POINT FUNC (__)
(01 - 16): ____

Enter the function number you wish to assign to the point and press . The existing setting is shown in parentheses on the first line. After you assign a point function, the previous window appears.

Alarm/Trouble status

Shortcut: 0-PROG, 4-PROG INPUTS, 1-POINT NUMBER

This feature allows you to program the system response to an open loop condition. A shorted loop always causes an alarm condition.



For acceptable programming selections for Listed applications that meet the requirements of the currently released edition of UL864, see *Programming features*, page 59.

ALARM: A point in an open circuit state causes an alarm.

TROUBLE: If a point is in an open circuit state, then the system responds with a trouble condition. Enter the point number you wish to program and press . The display scrolls through the PROG INPUT options.

Press  to select ALARM/TROUBLE. The following window appears:

```
OPEN STATUS ( )
1- ALARM
2- TROUBLE
```

Press  to select ALARM on open loop and ALARM on shorted loop or  to select TROUBLE on open loop and ALARM on shorted loop. The previous window appears. The existing setting is shown in parentheses on the first line.

Output zones

Shortcut: 0-**PROG**, 4-**PROG INPUTS**, 1-**POINT NUMBER**

Enter the point number you wish to program and press . The display scrolls through the PROG INPUT options.

Press  to select OUTPUT ZONE. The following window appears:

```
OUTPUT ZONE ZZZ
(01 - 50):_____
```

Press the number key that corresponds to your selection. ZZZ indicates the point being programmed. The existing setting is shown on the second line. After you set up the output zone, the previous window appears.

Verification

Shortcut: 0-**PROG**, 4-**PROG INPUTS**, 1-**POINT NUMBER**

If an input point is configured as “Alarm verification” and goes into an active state, then the panel does not immediately annunciate the alarm, activate associated outputs or send a signal. Instead, it resets the input point/addressable smoke detector and waits for a second alarm before annunciating the event.

The total delay introduced by this feature is equal to the smoke power reset time plus five seconds.

Alarm verification is applicable only to 2-wire smoke detectors or addressable smokes configured for fire. The alarm verification option is not applicable to other point types such as Waterflow and supervisory point types.

- The alarm verification feature can be used with four loops of 2-wire smoke detectors or addressable smokes configured for fire or one loop (on-board point) of 4-wire smoke detectors powered through the onboard smoke power (SMK PWR). For an illustration of typical device wiring, see *FACP terminal connection*, page 36.
- The alarm verification option is arranged on a per point basis.
- After the alarm verification period starts, any alarm from anywhere in the system that occurs during the alarm verification cycle immediately results in an alarm indication.
- The alarm verification timer is system wide; thus, only one timer applies for the whole system.

- The alarm verification timer is user programmable, ranging from 6 to 21 seconds for the RETARD-RESET-RESTART period, plus 60 seconds for the CONFIRMATION period. The default is 11 seconds.
- A reset command is sent to reset the input point on SLCs for alarm verification.
- The global alarm verification zone 59 is activated during the A - B verification period.



Notice!

CSFM installations require the alarm verification Retard-Reset-Restart (A-C) time to be a maximum of 30 seconds. This time is not programmable and is always less than 30 seconds



Notice!

Alarm Verification is configurable for the four onboard points and Addressable smoke detectors only.

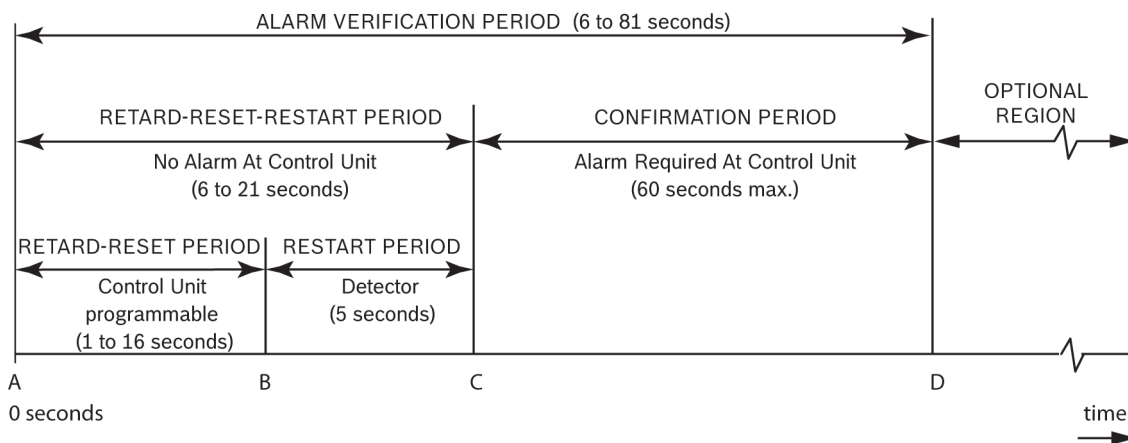

Enter the point number you wish to verify and press . The display scrolls through the PROG INPUT options.

Press to select VERIFICATION. The following window appears:

```
ALARM VERIF (ZZZ)
_____: YES(1) NO(0)
```

ZZZ indicates the point being programmed. The existing setting is shown on the second line. Press either to verify or to not verify. The previous window appears.

Latching

Shortcut: **0-PROG, 4-PROG INPUTS, 1-POINT NUMBER**

If a zone is non-latching, then the system resets the alarm status automatically (but does not reset smoke power) when the input restores to the standby condition. Otherwise, the system must be manually reset.

For acceptable programming selections for Listed applications that meet the requirements of the currently released edition of UL864, see *Programming features, page 59*.

Enter the point number you wish to program and press . The display scrolls through the PROG INPUT options.

Press to select LATCHING. The following window appears:

LATCHING? ZZZ
:YES(1)NO(0)

ZZZ indicates the point being programmed. The existing setting is shown on the second line. Press the number key that corresponds to your selection. Select YES for alarm. The previous window appears.

Point description

Shortcut: 0-PROG, 4-PROG INPUTS, 1-POINT NUMBER

For this feature, use the numeric keys to enter alphanumeric information to identify each input (such as initiating circuit). The system allows one 16-character description per input. Enter the point number you wish to program and press . The display scrolls through the PROG INPUT options.

Press to select DESCRIPTION. The following window appears:

PNT DSCRPTN ZZZ:

Enter the description using the numeric, and keys, then press to save the description.

8.4.2

Point function

Shortcut: 0-PROG, 4-PROG INPUTS, 2-POINT FUNCTION

There are 16 point functions, each of which has programmable features for: configuration (fire, waterflow, and so on), local only operation, silencing, and loop response.



Notice!

At default, points 9 to 255 are programmed as Function 10 which is set as Fire. Function 11 is set as Supervisory. Function 04 is set as Waterflow 16 second.

The following window appears:

POINT FUNC (__)
(01 - 16): _____

Enter the function number you wish to program and press . The following window appears:

PROG FUNCT
0- CONFIGURE
1- LOCAL ONLY
2- (reserved)
3- SILENCABLE
4- LOOP RESPONS
5- (reserved)
<DRILL>-NXT FCT
<HIST>-PREV FCT

Enter the function you wish to program.

Configure

Shortcut: 0-PROG, 4-PROG INPUTS, 2-POINT FUNCTION

- **Fire:** When activated, the point displays FIRE ALARM on control panel and keypads, activates selected output devices, and sends a Fire Alarm report (if programmed). Fire points are defaulted to a latch when first configured.
- **Waterflow:** When activated, the point displays xxx/xxx WTF on control panel and keypads, activates selected output devices, and sends a Waterflow Alarm event (if programmed). Waterflow points are defaulted to a non-verify characteristic when first configured.
- **Supervisory:** When activated, the point displays xxx/xxx SUP on control panel and keypads, and sends a Supervisory Alarm event (if programmed). Supervisory points are defaulted to a non-verify characteristic when first configured.
- **Reset:** When activated, the point initiates a control panel-reset operation to clear alarms and reset smoke detectors. Only points 1 to 8 can be configured as reset points.
- **Silence:** When activated, the point initiates a control panel silence operation to turn off sounders if the control panel is configured to allow silencing. Only points 1 to 8 can be configured as silence points.
- **AC Fault:** When activated, the control panel indicates AC FAIL TROUBLE and the TROUBLE LED turns on. The panel then waits for the AC Delay Timer to expire before sending an AC Fail report and activating zone 60 (AC fail).

Enter the point number you wish to program and press . The display scrolls through the PROG FUNCTION options.

Press to select CONFIGURE. The following window appears:

```
ACTVTN TYPE ( )
1- FIRE
2- WATERFLOW
3- SUPERVISORY
4- (reserved)
5- RESET
6- SILENCE
7- AC FAULT
```

Press the number key that corresponds to your selection. (The existing setting is shown in parentheses on the first line.) The previous window appears.

Local only

Shortcut: 0-**PROG**, 4-**PROG INPUTS**, 2-**POINT FUNCTION**

Enabling this feature provides the input point for local annunciation only with no communicator report except Reset and Silence functions. Enter the point number you wish to program and press . The display scrolls through the PROG FUNCTION options.

Press to select LOCAL ONLY. The following window appears:

```
LOCAL ONLY
_____: YES (1)NO(0)
```

Press either to enable or to disable. The previous window appears.

Silencing

Shortcut: 0-**PROG**, 4-**PROG INPUTS**, 2-**POINT FUNCTION**

This feature determines if an output zone (1 to 50) follows the Silence key (relays reset, NACs silence).

Enter the point number you wish to program and press . The display scrolls through the PROG FUNCTION options.

Press to select SILENCEABLE. The following window appears:

```
SILENCABLE? (FF)
_____: YES (1)NO(0)
```

Press for relays to reset and NACs to silence when the Silence key is pressed, or press for relays to remain latched until reset and NACs to continue sounding when the Silence button is pressed.



Notice!

When an output is assigned to more than one zone, the programming of the zone that triggers the output controls the output. When more than one zone triggers the output, if one of the zones is programmed as non-silencing, then the output will be non-silencing.

The previous window appears. FF indicates the function being programmed.

Loop response

```
Shortcut: 0-PROG, 4-PROG INPUTS, 2-POINT FUNCTION
```

This feature allows you to configure points to activate with standard response time (setting 1) or one system-wide programmed response time (setting 2).

Enter the point number you wish to program and press . The display scrolls through the PROG FUNCTION options.

Press to select LOOP RESPONSE. The following window appears:

```
RESPNS TIME ( )
1- FAST (.5 sec)
2- PRGRMMD*
```

* For acceptable programming selections for Listed applications that meet the requirements of the currently released edition of UL864, see *Programming features, page 59*.

Press the number key that corresponds to your selection (the existing setting is displayed in parentheses on the first line). The previous window appears.

When you select a programmed response time, the system asks you to enter a response time from 1 sec to 89 sec that applies to all functions. All functions share a single programmable response time setting. If this time is set for multiple functions, then the last time set is used.



Notice!

Up to 20 points can be assigned to point functions that were programmed with a response time other than Fast. If more than 20 points are assigned to functions programmed with a response time other than Fast, then an error message appears: PRGRMMD POINTS EXCEED MAX. Switching a point function from Fast to Programmed can cause this error, depending on how many points reference the point function.

<DRILL> NEXT FCT: Pressing retrieves the next function. For instance, if you are programming Point Function 2 and you press , then you retrieve the setting for Point Function 3.

<HIST> PREV FCT: Pressing returns you to the previous function. For instance, if you are programming Point Function 2 and you press , then you return to the setting for Point Function 1.

8.5 PROG OUTPUTS

PROG OUTPUTS

- 1- NACs
- 2- RELAYS

8.5.1 Programming NACs

Shortcut: 0-**PROG**, 5-**PROG OUTPUTS**, 1-**NACs**

The main control panel includes two local NACs (NAC 1 and NAC 2). The FACP can also support up to four FPP-RNAC-8A-4C Remote NAC Power Supplies, which offers a total of 16 remote NACs (four NACs per RNAC).



Notice!

When connecting FPP-RNAC-8A-4C Power Supplies to the FPD-7024 Option Bus, all the power supplies must be in the same zone.

The following window appears:

NAC OUTPUTS
1- LOCAL
2- REMOTE 1
3- REMOTE 2
4- REMOTE 3
5- REMOTE 4

Press the number key that corresponds to your selection.

Local NACs

Shortcut: 0-**PROG**, 5-**PROG OUTPUTS**, 1-**NACs**

The display scrolls through the NAC options. Press **1** for LOCAL. The following window appears:

ONBOARD NAC
1- NAC #1
2- NAC #2

Press the number key that corresponds to your selection. The display scrolls through the following selection:

PROG NACs
1- (reserved)
2- CONFIGURATION
3- ZONE ASSIGNS

Press the number key that corresponds to your selection.

If you select **3** from the PROG NACs menu, then the following selections scroll:

```
NAC CONFIG ( )
1- STEADY
2- PULSING
3- CALIFORNIA
4- TEMPORAL
5- WHEELLOCK
6- GENTEX
7- SYS SENSOR
```

For acceptable programming selections for Listed applications that meet the requirements of the currently released edition of UL864, see *Programming features, page 59*.

These selections control the pattern (code) for the selected NAC. Press the number key that corresponds with the desired pattern:

- **Steady:** Output turns on and stays on while the NAC is active.
- **Pulsing:** Output turns on for 0.5 sec and off for 0.5 sec.
- **California March:** Output turns on for 0.25 sec and off for 0.25 sec.
- **Temporal:** Output turns on and off to implement the ANSI standard evacuation pattern (Temporal code 3).
- **Wheellock:** Output is configured to support Wheelock devices with synchronization capability, including the ability to silence the horn of a combination horn strobe. The Wheelock configuration is not supported by remote NACs implemented using a Remote NAC power supply.
- **Gentex:** Output is configured to support Gentex devices with synchronization capability, including the ability to silence the horn of a horn strobe combination.
- **System Sensor:** Output is configured to support System Sensor devices with synchronization capability, including the ability to silence the horn of a horn strobe combination.



Notice!

With Wheelock, Gentex, and System Sensor products, the local NACs and RNACs are **not** in synch. Furthermore, Gentex NACs are synchronized on NAC1 and on NAC2 but are not synchronized between the on-board NACs (NAC1 and NAC2), and must be installed in separate loops that are not visible from one to the other.

After you program the desired pattern configuration, the previous window appears. If you select 3 from the PROG NACs menu, then you are asked to enter four zones to activate this output.

```
OUTPUT ZONE A (XX)
(00-63):
```



Notice!

XX” indicates the existing setting for each of the four output zone settings.

Enter the desired zone to activate this output and press . You are asked to enter up to four zones (A, B, C, D). Enter 00 (or leave it set at “00”) for any unused zones to prevent unintentional output activation. After all four zones are programmed, the previous window appears.

For a list of pre-assigned zones, see the Pre-assigned zones table in *Point/Zone Mapping*, page 55.

Remote NACs

Shortcut: 0-**PROG**, 5-**PROG OUTPUTS**, 1-**NACs**



Notice!

Synchronization

When using System Sensor NACs, the four NACs available on a specific RNAC are synchronized, but the NACs on one RNAC are not synchronized with the NACs on the other RNACs. The RNAC loops should be installed so that the NACs connected to each RNAC are not visible to or from the NACs connected to the other RNACs,

Use only with the FPP-RNAC-8A-4C. The display scrolls through the NAC options. Press **▲** for REMOTE 1, **▶** for REMOTE 2, **◀** for REMOTE 3, or **◻** for REMOTE 4. One of the following windows appears:

REM EXP NAC #1		REM EXP NAC #2		REM EXP NAC #3		REM EXP NAC #4
1- NAC #1	or	1- NAC #1	or	1- NAC #1	or	1- NAC #1
2- NAC #2		2- NAC #2		2- NAC #2		2- NAC #2
3- NAC #3		3- NAC #3		3- NAC #3		3- NAC #3
4- NAC #4		4- NAC #4		4- NAC #4		4- NAC #4

Press the number key that corresponds with the NAC you want to program. The display scrolls through the following selections:

PROG NACs
 1- (reserved)
 2- CONFIGURATION
 3- ZONE ASSIGNS

The options for remote NACs are the same as for local NACs.

Output Configuration:

Steady: Programmed to turn on steadily for a fire alarm.

Pulsing: Programmed to pulse for a fire alarm at 0.5 sec on and 0.5 sec off.

California March: Output turns on for 0.25 sec and off for 0.25 sec.

Temporal: Programmed to pulse for a fire alarm in Temporal 3.

Zone Assignment: Assign each output up to four zones. ZONE A, B, C, or D (00 = disabled) (1 to 63).

Press the number key that corresponds to your selection. After you program the local NACs, the previous window appears.

8.5.2

Programming relays

Shortcut: 0-**PROG**, 5-**PROG OUTPUTS**, 2-**RELAYS**

The main control panel includes three on-board relays (Relay 1, Relay 2, and Relay 3). The FACP can also support up to two D7035 Octal Relay Modules (Remote Relay 1 and Remote Relay 2), that offer a total of 16 remote relays (eight relays per module).The following window appears:

```

RELAY OUTPUTS
1- LOCAL
2- REMOTE 1
3- REMOTE 2
4- MULTIPLEX

```

Press the number key that corresponds to your selection.



Notice!

The option for multiplex relay programming is visible only when a Multiplex Expansion Module is installed.

Local Relays

```

Shortcut: 0-PROG, 5-PROG OUTPUTS, 2-RELAYS

```

The display scrolls through the Relay options. Press 1 for LOCAL. The following window appears:

```

ONBOARD RELAY
(1-3):

```

Enter the number corresponding to the relay to be programmed and press 4. The display asks you to enter four zones to activate this output:

```

OUTPUT ZONE A: _____
(00 - 63): _____

```

Enter the first zone (00 to 63) you want to assign to this output and press 4. A similar display for Zones B, C and D will appear to allow up to four zones to be assigned to this output. When all four zones are assigned, the previous window appears.

For pre-assigned zones, see the Pre-assigned zones table in *Point/Zone Mapping, page 55*. An output point cannot be assigned to more than four zones. Each output does not need to be assigned to four zones. Each zone can have any number of outputs assigned to it.

Remote relays

```

Shortcut: 0-PROG, 5-PROG OUTPUTS, 2-RELAYS

```

The display scrolls through the Relay options. Press 2 for REMOTE 1 or 3 for REMOTE 2. The following window appears:

```

REMOTE RELAY @ x
(1 - 8):

```



Notice!

The @ x shows the address of the relay module in the system. The lower number address is Relay 1; the higher one is Relay 2. When you address a MUX Module, you assign an address. If you have a dual point, then it would have two consecutive addresses.

Enter the relay you wish to assign and press 4. The display shows:

OUTPUT ZONE A: _____
(00-63): _____

Enter the output number (00 to 63) you want to assign to Zone A and press . A similar display for Zone B appears. When all four zones are assigned, the previous window appears. For pre-assigned zones, see the Pre-assigned zones table in *Point/Zone Mapping*, page 55. An output point cannot be assigned to more than four zones. Each output does not need to be assigned to four zones. Each zone can have any number of outputs assigned to it.

Multiplex relays

Shortcut: 0-**PROG**, 5-**PROG OUTPUTS**, 2-**RELAYS**



Warning!

Do not use this menu to program addresses configured as inputs.

The display scrolls through the Relay options. Press  for MULTIPLEX. The following window appears:

MUX OUTPUT
(009 - 255):

Enter the number corresponding with the output to be programmed and press . The output number of a multiplex relay is the second point of an I/O module. Adding 1 to the address of the I/O module gives the address of the relay in the module. When the relay is selected, the display asks you to enter four zones to activate this output:

OUTPUT ZONE A: _____
(00 - 63): _____

Enter the first zone (00 to 63) you want to assign to this output and press . A similar display for Zone B, C and D appears, allowing up to four zones be assigned to this input. When all four zones are assigned, the previous window appears.

An output point cannot be assigned to more than four zones. Each output does not need to be assigned to four zones. Each zone can have any number of outputs assigned to it.

8.6

PROG ACCOUNTS

PROG ACC'NTS

- 1- PHONE/IP NUMS
- 2- PHON CONTROL
- 3- RPT STEERING
- 4- RING COUNT
- 5- COMM. TRIES
- 6- MACH. BYPASS
- 7- ALT.COMM

8.6.1

Phone Numbers/IP Addresses

Shortcut: 0-**PROG**, 6-**PROG ACC'NTS**, 1-**PHONE/IP NUMS**

The system can be programmed with two reporting phone numbers or IP addresses. Phone/IP #1 is used with Account Number 1; Phone/IP #2 is used with Account Number 2. Remote programming occurs on Line 1 using Phone/IP #3.

- PHONE/IP #1: Phone Number 1 or IP address 1
- PHONE/IP #2: Phone Number 2 or IP address 2
- COMPTR PHONE/IP: Sets the Phone Number or IP Address to call for remote programming.

For acceptable programming selections for Listed applications that meet the requirements of the currently released edition of UL864, see *Programming features, page 59*.

The following window appears:

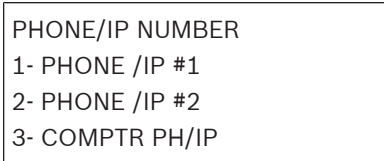

Press the number key that corresponds with the phone number you wish to configure (example is Phone #1). The following window appears:

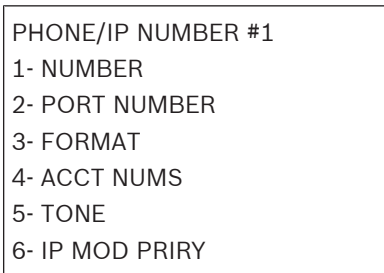

Press the number key that corresponds with your selection. Refer to the next four sub-sections (Number, Format, Account Numbers and Tone) for explanations of the phone number options.

Number/IP address

The display scrolls through the Phone /IP Number options. Press for NUMBER. The following window appears:

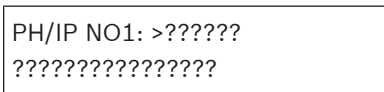

Press . Press to add the wait for dial tone, and then enter the phone number and press . The previous menu appears. You can include several other special control characters in the phone number by pressing followed by a digit.

For a list of control characters, see the following table:

Press	See	Action
	*	Touch Tone “*”
	#	Touch Tone “#”
	/	Three-second delay
	>	Wait for dial tone

Tab. 8.18: Phone number control characters

Several keys assist when you enter phone or IP numbers. For these keys, see the following table:

Press	Action
	Advance to next position

Press	Action
⊘	Go back one position
⌂	Clear position

Tab. 8.19: Phone number assistance keys



Notice!

For a phone number, you must enter 1 as a prefix before the special character >. Except for unusual situations, all phone numbers should have the wait for dial tone character as the second digit. This ensures that reports are delivered as quickly as possible, even if an incoming phone call must be disconnected. For example, you would program 1>18002890096 for the phone number 1 800-289-0096.
 If the wait for dial tone is not specified, then the control panel waits 3 seconds after going off-hook and then dials whether or not the dial tone is present.

To enter a central station IP address in either phone number 1 or 2 in the control panel, replace all three phone numbers with an IP address. To distinguish an IP address from a phone number, enter 0 as the first digit, followed by the 12 digit IP address.



Notice!

The IP address must be 12 digits long. For example, if the IP address is 172.30.1.101, then the address is programmed as 0172030001101.

Digit 1	Digit 2	Digit 3	Digit 4	Digit 5	Digit 6	Digit 7	Digit 8
0 = Alt Comm. On	IP1	IP2	IP3	IP4	IP5	IP6	IP7
Digit 9	Digit 10	Digit 11	Digit 12	Digit 13	Digit 14	Digit 15	Digit 16
IP8	IP9	IP10	IP11	IP12	Common Ack Wait N2	Common Ack Wait N1	Common Ack Wait N0
Digit 17	Digit 18	Digit 19	Digit 20	Digit 21	Digit 22		
HB interval N2	HB interval N1	HB interval N0	1 = Anti-Replay On	ACK wait time unit 0=sec, 1=min	HB Interval time unit 0=sec, 1=min, 2=hr		

Figure 8.1: IP address and bit locations

For timing configurations, see the following table:

Configured Supervision Time	Acknowledge wait time (digits 14, 15, 16, and 21)	Heartbeat interval ¹ (digits 17, 18, 19, and 22)	Communication tries
090 sec	Ethernet = 005 sec Cellular = 015 sec	030 sec	Ethernet = 5 Cellular = 1
180 sec	015 sec	060 sec	5
200 sec	015 sec	080 sec	5
005 min	015 sec	180 sec	5
001 hr	060 sec	053 min	5
004 hr	300 sec	205 min	5
024 hr	060 min	017 hr	5

¹ The heartbeat interval includes a built-in minimum 30 second buffer.

Tab. 8.20: Supervision time settings



Notice!

Before NFPA 2013, the maximum supervision time was 300 seconds; NFPA 2013 changed that time to 1 hour.

Acknowledge Wait Time (ACK)



Notice!

The ACK WAIT TIME is programmed in digits 14 to 16 and digit 21.

The alternate communication event, transmission acknowledge wait time, is stored in the phone number location as digits 14, 15 and 16 with the time unit (seconds or minutes) stored in digit 21. The ACK wait time is a number from 1 to 255 seconds/minutes where the most significant or first digit is D14.

For example, if the necessary ACK wait time is 30 sec, then digits 14 through 16 should be 0, 3, 0 respectively, and digit 21 should be 0.

In larger installation sites using alternate communications as a destination, set the ACK wait time to a higher value to compensate for network congestion delays. This wait time is also used for the heartbeat acknowledge wait time.

A time-out on an alternate communication path is treated the same way as a negative acknowledgement and results in the same event routing default scheme used with phone reporting to the central station. This allows alternate communications to be the primary or secondary reporting paths to an actual phone number for a single reporting destination.

For the alternate communications path, see the following table:

Attempt	Primary physical path	Secondary physical path
1	1st phone number/IP address	
2	2nd phone number/IP address	

Attempt	Primary physical path	Secondary physical path
3		1st phone number/IP address
4		2nd phone number/IP address
5	2nd phone number/IP address	
6	1st phone number/IP address	
7		1st phone number/IP address
8		2nd phone number/IP address
9	2nd phone number/IP address	
10	1st phone number/IP address	

Tab. 8.21: Reporting paths

Heartbeat Interval (HB)



Notice!

The Heartbeat Interval, also known as Polling Time, is programmed in digits 17 to 19 and digit 22.

This interval is a value between 001 and 255 that indicates the number of seconds/minutes/ hours between heartbeat events sent from the control panel. The heartbeat event is sent only when the communication path is idle for at least the programmed heartbeat interval period of time. The value is stored in phone number digits 17 through 19 with 17 being the most significant or first digit. Digit 22 identifies the unit of time (seconds, minutes, or hours). A value of zero in these locations disables the heartbeat feature. These digits are always zero in the remote programmer phone number.

The heartbeat feature is an acknowledged test event sent to the central station receiver over a network connection. This event does not appear at the central station, and it is not logged in the control panel as an actual event. The heartbeat event is used as a periodic test of the virtual circuit between the control panel and the networked receiver. The event format always remains the same regardless of the communication protocol formats available in the control panel.

Anti-replay



Notice!

Anti-replay is programmed in digit 20 and has a default=1.

Digit 20 of the phone number enables the Anti-Replay Feature for central station communications. A zero in this location disables this feature. This digit is always zero in the remote programmer phone number.

The purpose of Anti-Replay is to prevent malicious or accidental repetition of event packets to the central station network receiver. A communication packet can be recorded on a network and replayed in its entirety as if it came from the control panel. If for some reason the packets become out of sequence, then the communication path generates a communications failure event and must be manually resynchronized.

Port Numbers

Shortcut: 0-**PROG**, 6-**PROG ACC'NTS**, 1-**PHONE/IP NUMS**

The port numbers identify the control panel when it sends reports to the Conettix module. (For normal installation, set this to 07700).

The display scrolls through the Phone or IP Number options. Press  for PORT NUMS. The following window appears:

PORT #1: 00000
NEW NUMBER: 00000

The existing number is shown on the top line. Enter the new number on the second line and press . The previous window appears.



Notice!

For more information about using Conettix communications, see also the *Installation Guides* for the B420 or B426 module, the B450/B44x modules, or the DX4020 or ITS-DX4020-G module.

Format

Shortcut: 0-**PROG**, 6-**PROG ACC'NTS**, 1-**PHONE/IP NUMS**

Use this feature to select which communication format to use or to disable communication for the phone or IP number. To disable the dialer, set the format for Phone Lines 1 and 2 to disabled and turn off the monitoring feature of both lines.

The display scrolls through the Phone or IP Number options. Press  for FORMAT. The following window appears:

PHONE/IP FORMAT ()
0- DISABLE
1- 3/1 REPORT
2- 4/2 REPORT
3- BFSK REPORT
4- SIA, 110 RPRT
5- CONTACT ID
6- SIA, 300 RPRT
7- MDM 3A2

Press the number key that corresponds to your selection. The previous window appears.



Notice!

The Modem IIIa² and Contact ID formats are possible when using the B420 or B426 modules, the B450/B44x modules, or the DX4020 or ITS-DX4020-G module for reporting events:

Account Numbers

Shortcut: 0-**PROG**, 6-**PROG ACC'NTS**, 1-**PHONE/IP NUMS**

The account numbers identify the control panel when it sends reports to the central station. The display scrolls through the Phone or IP Number options. Press  for ACCOUNT NUMS. The following window appears:

```
ACCT 1: 0000000000
NEW : 0000000000
```

The existing number is shown on the top line. Enter the new number on the second line and press . The previous window appears. Enter hexadecimal digits A through F by pressing followed by for A, for B, for C, for D, for E and for F.

If the account number contains fewer than 10 digits, then the system auto loads leading zeros (for example, 1234 becomes 0000001234).



Notice!

followed by (A) is only valid in Modem IIIa²; the other formats will send 0 to the central station receiver.

Tone

```
Shortcut: 0-PROG, 6-PROG ACC'NTS, 1-PHONE/IP NUMS
```

The FREQ () programming items (refer to window below) modify the reporting format when 3/1 or 4/2 reporting is selected for the format. Select three parameters with one setting: data tone frequency, acknowledge tone frequency, and data rate. The frequency that the control panel uses to send data pulses can be set for 1900 Hz (19D) or 1800 Hz (18D). The frequency of the acknowledge tone from the receiver to which control panel responds can be set to 1400 Hz (14A) or 2300 Hz (23A). The rate at which the data pulses are sent can be set to 10, 20, or 40 pulses per second (10PS, 20PS or 40PS).

The display scrolls through the Phone/IP Number options (refer to 52). Press for TONE. The following window appears:

```
FREQ ( )
1- 19D, 14A, 10PS
2- 18D, 23A, 10PS
3- 19D, 14A, 20PS
4- 18D, 23A, 20PS
5- 19D, 14A, 40PS
6- 18D, 23A, 40PS
```

Press the number key that corresponds to your selection. The previous window appears.

IP MOD PRIRY

This configuration (refer to window below) is always available no matter how many IP modules are connected. If there is only one IP module connected, then the configuration will be ignored in the logical process for reporting and only one IP module will be used for reporting. The IP module at address 250 will always be the default.

```
IP MOD PRIRY (1)
1- 250 AS PRIM
2- 134 AS PRIM
```

8.6.2

Phone Control

```
Shortcut: 0-PROG, 6-PROG ACC'NTS, 2-PHONE CONTROL
```

In addition to features associated with each phone and IP number, each phone line has associated features.

```

PHONE CONTROL (1)
1- LINE #1
2- LINE #2

```

Press the number key that corresponds with your selection. Line 1 and Line 2 have the same options. The following window appears:

```

PHONE CONTROL #1
1- MONITOR LINE
2- DIALING TYPE

```

For explanations of the phone control options, see the following sections for Monitor Line and Dialing Type.

Monitor Line

```

Shortcut: 0-PROG, 6-PROG ACC'NTS, 2-PHONE CONTROL

```

The phone line monitor feature, that supervises the connection of the phone line to the control panel, can be disabled for each phone line. When an IP address is entered for the Phone/ IP number, set the monitor to No. If this is not programmed to No, then a trouble is generated. Choose Line 1 or Line 2 (see the window above). The display scrolls through the Phone Control options. Press **1** for MONITOR LINE. The following window appears:

```

MONITOR LINE #1
_____: YES (1) NO (0)

```

For acceptable programming selections for Listed applications that meet the requirements of the currently released edition of UL864, see *Programming features, page 59*.

Press **1** for YES or **0** for NO. The previous window appears.

Dialing Type

```

Shortcut: 0-PROG, 6-PROG ACC'NTS, 2-PHONE CONTROL

```

This feature determines the format the control panel uses for dialing on each phone line. The TONE/PULSE setting first tries tone dialing. If that fails, it switches to pulse dialing. If an IP address is entered in for the Phone/IP number, then the control panel ignores this setting. Choose Line 1 or Line 2 (see the window below). The display scrolls through the Phone Control options. Press **2** for DIALING TYPE. The following window appears:

```

PHONE CONTRO ( )
1- PULSE ONLY
2- TONE/PULSE
3- TONE ONLY

```

Press the number key that corresponds to your selection. The previous window appears.

8.6.3

Report Steering

```

Shortcut: 0-PROG, 6-PROG ACC'NTS, 3-RPT STEERING

```

Different classes of reports can be directed to different phone numbers. Non-supervisory alarms include fire alarms and waterflow alarms. Supervisory alarms come from points configured as a supervisory type. Non-supervisory restorals include fire and waterflow restorals. Supervisory restorals come only from points configured as a supervisory type.

Trouble reports include all point and system troubles and restorals. Tests include Auto Tests, Manual Tests and Off-normal at Test Reports. The control panel allows the special reports Silence, Reset, and Drill to be individually directed.



Notice!

If any reports are directed to Phone/IP Number 2 (including the default, PHONE 2 BACKUP), then a phone number and account number must be programmed for Phone/IP Number 2. The control panel indicates a COMM FAULT if it sends a report (using Phone Number 1 parameters) which references unprogrammed Phone/IP Number 2 parameters.

The display scrolls through the following items:

```
REPORT STEERING
1- NONSUP ALRM
2- SUPVSY ALRM
3- NONSUP RSTR
4- SUPVSY RSTR
5- TROUBLE
6- TESTS
7- SILENCE
8- RESET
9- FIRE DRILL
```

Press the number key that corresponds to your selection. Selecting, for example, NONSUP ALRM produces the following window:

```
NONSUP ALRM ( )
1- PH/IP 1 ONLY
2- PH/IP 2 ONLY
3- PH/IP 1 & 2
4- PH/IP 2 BKUP
5- NO REPORT
```

PHONE/IP#1 ONLY: Panel sends the report to Phone/IP #1 receiver using the primary physical path (Disable monitor line 2 when PSTN used).

PHONE/IP#2 ONLY: Panel sends the report to phone/IP #2 receiver using the primary physical path (Disable monitor line 2 when PSTN used).

PHONE/IP#2 BACKUP: The panel sends the report to Phone/IP #1 receiver using the primary physical path. if report fails, then the panel sends the report to Phone/IP #2 receiver using the primary physical path. if this report also fails, then the panel sends the report to Phone/IP #1 receiver using the secondary physical path. if this report fails, then the panel sends the report to Phone/IP #2 receiver using the secondary physical path.

PHONE/IP#1 AND 2: The panel sends the report to Phone/IP #1 receiver using the primary physical path and also to Phone/IP #2 receiver using the primary physical path. if these reports fail, then the panel sends the reports to Phone/IP #1 receiver using the secondary physical path and also to Phone/IP #2 receiver using the secondary physical path.

NO REPORT: No report sent.

Press the number key that corresponds with your selection. The previous window appears.

8.6.4

Ring Count

Shortcut: 0-PROG, 6-PROG ACC'NTS, 4-RING COUNT

**Notice!**

Set to 0 the number of phone rings before the control panel seizes the line to attempt remote programming. The number of phone rings before the panel seizes the line to attempt remote programming must remain at 0 for UL864 local, auxiliary, or remote station installations. If an IP address is entered for the Phone/IP number, then the panel will ignore this setting. When the ring count is set to 0, remote programming must be answered on site. Once answered, the panel will prompt for a password.

The following window appears:

RING COUNT
 (01-15, 00=DIS) _____

Enter the information and press . The previous window appears. An entry of disables ring detection.

For acceptable programming selections for Listed applications that meet the requirements of the currently released edition of UL864, see *Programming features*, page 59.

8.6.5**Communication Tries**

Shortcut: 0-**PROG**, 6-**PROG ACC'NTS**, 5-**COMM. TRIES**

The system default is to try ten times to communicate an event. Bosch recommends setting this to five tries. This parameter determines after which attempt the system indicates a failure condition. (After reporting a failure, the system continues to communicate until it reaches ten times). Do not select 1 or a failure is indicated whenever a report is sent.

The following window appears:

COMM. TRIES (____)
 (01-10): _____

Enter the information and press . The previous window appears.

8.6.6**Machine Bypass**

Shortcut: 0-**PROG**, 6-**PROG ACC'NTS**, 6-**MACH BYPASS**

The downloading computer must redial the control panel if an answering machine answered the phone before the control panel. When this option is selected, if the control panel detects the phone line ringing within one minute of when the last ringing cycle stopped, then it answers on the first ring and seizes the phone line. If an IP address is entered in for the Phone/IP number, then the control panel ignores this setting.

The following window appears:

MACHINE BYPASS
 _____: YES (1) NO (0)

Enter the information and press . The previous window appears.

8.6.7**ALT. COMM**

Shortcut: 0-**PROG**, 6-**PROG ACC'NTS**, 7-**ALTER COMM**

This prompt is used with the B420 or B426 modules, the B450/B44x modules, the DX4010V2 module, and the DX4020 or ITS-DX4020-G module.

When using the DX4010V2, select 1-serial; for all others, select 0-network. The following window appears:

```
ALTER COMM ( )
0- NETWORK
1- SERIAL
```

8.7 PROG FORMATS

PROG FORMATS
 1 - 4/2 ZONE REPT
 2 - 4/2 RPT CODS
 3 - BFSK RPT CDS



Notice!

This feature offers the use of hexadecimal digits (0 through F). Because the specific keys A through F are not available on the keypad, use the following equivalent keys: =A, =B, =C, =D, =E, and =F

8.7.1 4/2 Zone Report

Shortcut: 0-**PROG**, 7-**PROG FORMATS**, 1-**4/2 ZONE RPTS**

4/2 Zone reports consist of an event type (first digit) and a point number (second digit). These reports apply only to points, and only when a 3/1 or 4/2 format is selected. The following window appears:

```
4/2 ZONE RPT
0- FIRE ALRM D1
1- FIRE RSTR D1
2- WATERFLOW D1
3- SUPERVISE D1
4- TROUBLE D1
5- TRBL RSTR D1
6- DISABLE D1
7- DSBL RSTR D1
8- (RESERVED)
9- MORE
```

Press the number key that corresponds with your selection of event type (D1 stands for digit 1). Press .

Pressing retrieves the second digit options (point numbers). The following window appears:

```
4/2 ZONE RPT
1- POINT 1 D2
2- POINT 2 D2
3- POINT 3 D2
4- POINT 4 D2
5- POINT 5 D2
6- POINT 6 D2
7- POINT 7 D2
8- POINT 8 D2
9-MORE
```

Pressing retrieves the second digit options (point numbers). The following window appears:

```
4/2 ZONE RPT
1- POINT 9 D2
2- POINT 10 D2
3- RETURN TO D1
```

Press the number key that corresponds to your selection. A window based on your previous selection allowing entry of hex digits appears:

```
FIRE ALARM D1 ( )
0 THRU 9
<HISTORY>:A
<TEST>:B
<DISABLE>:C
<DRILL>:D
<SILENCE>:E
<RESET>:F
```

Enter the digit that corresponds to the selected condition by pressing a number key or one of the special keys if a hex character is needed. Press  and the previous display appears.

8.7.2

4/2 Report Codes

Shortcut: 0-**PROG**, 7-**PROG FORMATS**, 1-**4/2 RPT CODS**

4/2 Report Codes apply to system conditions but only when 3/1 or 4/2 format is selected. Two digits can be programmed to be sent for each condition. The conditions that can be programmed are:

System in test, system in test restore: sent for walk test operations

Silence: sent when the silence key is pressed

Fire drill, fire drill restore: sent for fire drill operations

Open reset report: sent when the reset key is pressed

Low battery, low battery restore, AC failure, AC failure restore: sent for power problems

Test report: sent for manual or automatic communicator tests

Off normal at test: sent if the panel is off-normal at the automatic test time

Phone trouble, restore: sent for phone line problems

System trouble, restore: sent for general system problems

The following window displays:

```
4/2 RPT CODS
0- SYSTM IN TST
1- SYS TEST RST
2- SILENCE
3- FIRE DRILL
4- FIRE DRL RST
5- OPEN RST RPT
6- LOW BATTERY
7- LOW BATT RST
8- AC FAILURE
9- MORE
```

Pressing  allows programming additional reports:

```

4/2 RPT CODS
0- AC FAIL RST
1- TEST REPORT
2- OFF NORM TEST
3- PHONE 1 TRBL
4- PN 1 TRB RST
5- PHONE 2 TRBL
6- PN 2 TRB RST
7- SYSTEM TROUB
8- SYS TRB RST

```

Pressing  returns you to the previous group of reporting codes.

Press the number key that corresponds to your code selection. A window based on your previous selection allowing entry of two hex digits appears:

```

SYSTEM IN TST ( )
0 THRU 9
<HISTORY>: A
<TEST>: B
<DISABLE>: C
<DRILL>: D
<SILENCE>: E
<RESET>: F

```

Enter digits that correspond to the selected condition by pressing a number key, or one of the special keys if a hex character is needed. Press  and the previous display appears.

8.7.3

BFSK Report Codes

Shortcut: 0-**PROG**, 7-**PROG FORMATS**, 1-**BFSK RPT CODS**

When BFSK reporting is used, most reporting codes are fixed and do not need programming.

There are five reports that the control panel can send that are not standard BFSK codes:

Off normal at test: Sent if the panel is off-normal at the automatic test time.

Open reset report: Sent when the reset key is pressed.

Silence: Sent when the silence key is pressed.

Fire drill, fire drill restore: Sent for fire drill operations.

The following window displays:

```

BFSK RPT CDS
1- OFF NRM TEST
2- OPEN/RESET
3- SILENCE
4- FIRE DRILL
5- FR DRIL RSTR

```

Press the number key that corresponds to your report code selection. A window allowing entry of two hex digits appears.

8.8

HISTORY DEFAULTS

Shortcut: 0-**PROG**, 8-**HSTRY DEFLT**

The following window appears:

```

PROG DEFAULTS
1- CLEAR HSTRY
2- DEFAULT EE
3- ALT 4/2 CDES
4- (reserved)
    
```

8.8.1 Clear History

```

Shortcut: 0-PROG, 8-HSTRY DEFLTS, 1- CLEAR HISTORY
    
```

You can use this option to clear some or all of the history records in the system. The following window appears:

```

HIST ITEMS= _____
DEL OLDEST 000
    
```

Enter the number of history records you wish to delete, and press . The previous menu appears.

8.8.2 Default EE





Warning!

Lost programming!

All programming, including zone configurations and option installations, is lost when this operation is performed. You must turn control panel power off and on after resetting the default, to reinstall the four zone expanders and the MUX expander. You must update the option bus and set up keypads (PROG SYSTEM MENU) to reinstall option bus devices.

```

Shortcut: 0-PROG, 8-HSTRY DEFLTS, 2- DEFAULT EE
    
```

You can set the control panel back to the original factory-programming configuration with this option. You are asked to press  to complete the operation. Press  to cancel the operation. The following window appears:

```

PROG DEFAULTS
PLEASE WAIT . . .
    
```

When the operation is complete, the previous menu appears. This operation takes several minutes when a Multiplex Expander is installed.

8.8.3 Alternate 4/2 Codes

```

Shortcut: 0-PROG, 8-HSTRY DEFLTS, 3- ALT 4/2 CDES
    
```

You can set all of the programming for 4/2 codes to an alternative set of default reports, as described in *Appendix D: Programming Defaults List, page 121*. To cause a complete control panel default, use the default EE option.

The following window appears:

```

PROG DEFAULTS
PLEASE WAIT...
    
```

When the operation is complete, the previous menu appears.

8.9 Program MUX

```

Shortcut: 0-PROG, 9-PROGRAM MUX
    
```

**Warning!**

1. Unprogrammed devices on the bus will not operate or be supervised
2. This menu is accessible only when a Multiplex Expansion Module is installed.
3. Do not install more than one device programmed to the same address on the bus. Doing so can inhibit alarm reporting from both devices.

The following window appears:

```
PROGRAM MUX
1- MUX EDIT
2- (reserved)
3- MUX BUS TYPE
4- AUTO PROGRAM
```

8.9.1**MUX Edit**

Shortcut: 0-**PROG**, 9-**PROGRAM MUX**, 1- **MUX EDIT**

To add MUX devices to the system, use the MUX Edit option. Each device must have a unique address programmed using the address switches.

The following window appears:

```
DEVICE TYPE ( )
0- NO DEVICE
2- SINGLE INPUT
3- I/O MODULE
4- MUX SMOKE
5- (reserved)
6- DUAL INPUT
7- OCTAL INPUT
```

**Notice!**

Single input devices include the D7044/M, D7045, FMM-7045, FMM-7045-D, and D7052 (Class A). The I/O module is the D7053. The MUX smoke detectors are the D D7050, D7050TH, and D343. The dual input module is the D7052 (Class B). The Octal input module is the D7042.

Press the number that corresponds with the device you are adding or press  if you are removing a device. When the device type is selected, the following window appears:

```
POINT NUMBER
(009 - 255) 009
```

Enter the address of the point being added, and press . The device type window appears again allowing additional devices to be added. Eight points are added at once when the D7042 is added to the control panel.

8.9.2**MUX Bus Type**

Shortcut: 0-**PROG**, 9-**PROGRAM MUX**, 3- **BUS TYPE**

This option configures the system for two independent Class B buses allowing addresses up to 255.



Notice!

Class A operation is not supported by the D7042 Eight Input Module; do not select Class A operation.

The following window appears:

```
MUX BUS TYPE ( )
1- CLASS A
2- CLASS B
```

Press **▲** to select Class B operation if the setting was changed from the default setting. For wiring details for a Class B configuration, see also the *D7042/D7042B Multiplex Eight Input Remote Modules Installation Instructions*. For more information regarding Class A and Class B wiring instructions, see also the MUX expansion module’s *Installation Guide*.

8.9.3

AUTO PROGRAM

Shortcut: **0-PROG, 9-PROGRAM MUX, 4-AUTO PROGRAM**

This option provides a convenient way for the installer to configure the FACP to operate with the existing devices on the multiplex buses by scanning the buses for missing or new multiplex devices.

The following display appears:

```
AUTO PROGRAM?
_____:YES(1) NO(0)
```

Press **1** to continue with auto programming or **0** to cancel. When you press **1**, the FACP checks for existing programming errors in which devices are programmed incorrectly in the space required for a lower-addressed multi-point device (such as a dual point module). If a point is found to be programmed under another device, then the following error message appears for five seconds, and the auto programming process aborts:

```
ADDRESS ERROR 1
AT ADDRESS xxx
```

If no errors are found, then the FACP starts a scanning process that takes approximately one minute to complete, while showing the following display:

```
AUTO PROGRAM
SCANNING
PLEASE WAIT...
```

When the scanning is completed, the FACP checks for missing devices. Missing devices are addresses with no devices on the multiplex buses, but are programmed into the FACP’s site-specific memory area. If missing devices are detected, then the FACP shows the following menu (where xxx is the address of the first point of the missing device):

```
MISSING PT @ xxx
0- DELETE POINT
1- KEEP POINT
2- DEL REMAIN
3- KEEP REMAIN
```

DELETE POINT: When selected, the missing point and any addresses it implemented (up to eight for an octal input module) are permanently deleted from the site specific memory area. If the deleted device is an I/O module, then the output zones that were programmed for the relay are reset to 0. If additional devices are found to be missing, then the above display is repeated for each missing device.

KEEP POINT: When selected, the FACP retains the programming for the existing point and continues scanning for additional missing points.

DEL REMAIN: When selected, the following prompt # KEY TO CONFIRM appears at the FPD-7024. If the  key is pressed, then all the missing points are deleted from the site-specific memory area and the auto program process continues with the devices found menu. If any other key is pressed, then the existing point is kept and the control panel continues scanning for additional missing devices.

KEEP REMAIN: When selected, no additional points are deleted and the auto program process continues with the Devices Found menu. Points individually deleted with the Delete Point command before selecting the Keep Remain command stay deleted when Keep Remain is selected.



Warning!

Missing points!

Use the DEL REMAINING feature with caution. Any devices missing from the multiplex buses during the DEL REMAINING operation, even momentarily, are permanently deleted. These points do not operate, and do not generate trouble conditions even if they are returned to the bus.

When the delete point operation is finished, the FACP shows for five seconds the total number of points that were deleted from the control panel (xxx indicates the number of points that were removed from the control panel's site-specific configuration).

```
AUTO PROGRAM
xxx PNTS DELETED
```

Confirm that only the expected number of points was removed from the system. Points that are removed from the control panel's site-specific configuration do not operate and are not supervised even if they are returned to the bus.

When the point delete process completes, the auto programming process automatically checks for new devices on the buses. New devices are found when a device is present on one of the multiplex buses, but its address is not programmed into the control panel's site-specific memory. If new devices are detected, then the FACP shows the following menu (where xxx is the address of the first new device found):

```
NEW DEVICE @ xxx
2- SINGLE INPUT
3- I/O MODULE
4- MUX SMOKE
5- (reserved)
6- DUAL INPUT
7- OCTAL INPUT
0- NO DEVICE
```

Use this menu to define the device type. Press the number key that corresponds with the device type installed at the address. If a detected device should not be installed and should be left inactive, then press  to bypass the new device.



Warning!

Device malfunction!

Ensure that the correct device type is selected for each point. Incorrectly specified device types can cause multiplex devices to malfunction or fail to operate.

All inputs are configured to use Point Function 10 as they are added. Points added during auto programming are configured for the following operation:

- Point Function 10 (Fire Alarm, Fast Response, Non-silenceable, Not Local-only)
- Open Status = Trouble
- Output Zone 9
- Alarm Verify = NO
- Latching = YES

The programming of input points can be changed when auto programming completes using the input-programming menu.

When I/O modules are added during auto programming, the relay (second point) is configured to activate on any alarm, non-silenceable (Zone 63). This can be changed when auto programming completes by using the output-programming menu.

The FACP performs some basic error checks when new devices are added. The following errors can be shown during the process of adding a device:

ADDRESS ERROR #
AT ADDRESS xxx

In the previous message, # is replaced by a code number and xxx is replaced by the affected address that indicates the type of error.

For code numbers and corresponding error message descriptions, see the following table:

Code	Error	Description
1	New point is under an existing point	The new point is in the space required for an existing multi-address device. This is checked when auto programming first starts.
2	Point overlaps existing point	There are already devices configured at one of the addresses required for the new multi-point device.
3	Point is at an illegal address	The addresses at which multi-address devices can be installed are restricted.
4	Too many multiplex relays	Only 20 input output devices can be supported on a given bus.

Tab. 8.22: Auto programming error messages

For details on installation restrictions, see also the specific device’s installation instructions. When the point adding operation completes, the FACP shows for five seconds the total number of points that were added to the control panel. Confirm that the number of devices added matches the expected number.

AUTO PROGRAM
 xxx POINTS ADDED

**Warning!**

Undetected devices!

If a new device is not detected on the bus during the point adding operation, then the device does not operate and does not generate trouble conditions even if it remains connected to the bus.

When the point adding operation completes, the display shows the total number of points on the system:

PROGRAM COMPLETE
 xxx MUX POINT

Note that xxx is the total number of points, not devices.

Confirm that the system shows the exact number of points expected. Points that are not included in the total count do not operate and do not generate trouble conditions.

After the count of total points appears for approximately 10 sec, the FACP restores the multiplex system to normal operation. This process takes approximately 50 sec and the following message appears during the restoral process:

PROGRAM COMPLETE
 RESTORING
 PLEASE WAIT...

**Warning!**

Test for proper operation!

As with any programming change to a system, test the system for proper operation before returning it to service. At least test each added multiplex point after auto programming completes. Test according to NFPA 72.

8.9.4**Removing MUX Devices**

Shortcut: 0-**PROG**, 9-**PROGRAM MUX**, 1-**MUX EDIT**

To remove a previously programmed multiplex device, use the MUX Edit feature.

PROGRAM MUX
 1- MUX EDIT
 2- (reserved)
 3- MUX BUS TYPE
 4- AUTO PROGRAM

From the Program MUX menu, press  to select MUX Edit. The following window appears:

DEVICE TYPE ()	Description Model
0- NO DEVICE	0- NO DEVICE
2- SINGLE INPUT	2- SINGLE INPUT D7044/M, D7045, FMM-7045/-D, D7052 (Class A)
3- I/O MODULE	3- I/O MODULE D7053
4- MUX SMOKE	4- MUX SMOKE D7050, D7050TH, D343
5- (reserved)	
6- DUAL INPUT	6- DUAL INPUT D7052(Class B)
7- OCTAL INPUT	7- OCTAL INPUT D7042

Press  for No Device. Then enter the address for the point you wish to delete. After the device is successfully deleted, you return to the Device Type (MUX Edit) sub-menu. An unsuccessful deletion results in an error message (see below) followed by the Device Type (MUX Edit) sub-menu.

ERROR -
DEVICE FAILED



Warning!

Multiple point removal!

If you remove one point of a multiple address, then the entire module with the multiple address is removed.

9 Specifications



Notice!

When a local relay is programmed for general trouble (Zone 62), Position A will energize the relay in the normal state. Positions B, C, and D must be configured as Zone 0 (not programmed). This causes the common and normally-open terminals to be shorted when not in the trouble condition.

Electrical

Line impedance for ground fault detection (Option Bus, conventional input, NAC, secondary power circuit, MUX Bus, AUX power, SMK power):	10 kΩ or less
Power (Input):	120 V 60 Hz 1.4 A or 230/240 V 50 Hz, 0.7 A
Power (Auxiliary):	17 to 31 VRMS, unfiltered, 1.0 A
Power (Smoke) ¹ :	20.4 to 28.2 VDC nominal, filtered, 1.0 A.
Power (Option Bus):	12 VDC nominal, 500 mA
Power (Notification Appliance Circuit [NAC]) ² :	Each NAC has 24 FWR nominal, unfiltered power with up to 2.5 A capacity (but limited by panel's overall 4.0 A capacity)
Power (Optional Standby Batteries):	Two 12 V (in series), 7 Ah to 40 Ah
NACs Line Impedance (voltage loss)	1.5 V
Recommended Manufacturers: ³	Power Sonic: PS-1270, PS-12170, PS-12180 YUASA: NP7-12, NPG18-12
<p>¹ For compatible smoke detection devices, see also the <i>FPD-7024 Smoke Detector Compatibility List</i>.</p> <p>² For compatible NAC devices, see also the <i>FPD-7024 NAC Compatibility List</i></p> <p>³ If other manufacturers or battery types are used, ensure that the battery or batteries can handle an initial charge current of at least 1.7 A.</p>	

Environmental

Temperature (operating and storage):	+32°F to +120°F (0°C to +49°C)
--------------------------------------	--------------------------------

Notification Appliance Circuits (NACs)

Wiring:	Class B or Class A
Notification patterns:	Configurable for steady, pulsing, California March, Temporal (ANSI) code 3, synchronized Wheelock, synchronized Gentex, and synchronized System Sensor.

Relays

<p>Local (on-board):</p>	<p>The main control panel includes Three Form “C” relays. The relay contacts are rated at 5 A, 28 VDC. No over current limiting is performed on the contacts of these relays. The default selection for the relays is to indicate general alarm (relay 1), general system trouble (relay 2), and supervisory (relay 3). By using point or zone mapping, they can be programmed to activate in a wide variety of conditions.</p>
<p>Remote¹:</p>	<p>Eight Form C relay outputs are provided by a D7035 Remote Relay Module. The module connects to the FPD-7024 through the option bus. The outputs are fully programmable, exactly as the local relays are programmed. Each output operates independently of the other seven to provide complete flexibility. Communication with the D7035 is supervised. Contact Rating: 5 A at 28 VDC Number of Modules: two units maximum.</p>
<p>¹ For wiring requirements, see <i>Option bus wiring requirements, page 43</i>.</p>	

10 Appendices

10.1 Appendix A: Display Abbreviations

Abbreviation	Definition	Abbreviation	Definition
3/1	3/1 reporting format	IP	Internet Protocol address
4/2	4/2 reporting format	KPAD, KYPAD, KYPD	Keypad
@	Device address on Option Bus	LRelay	Local Relay
ACTVTN	Activation	LOC	Local
A, ALRM	Alarm	MACH	Answering Machine
ALT	Alternate	M, MONI, MON	Monitor
ANN, ANUN	Annunciator	NAC	Notification Appliance Circuit
BAT, BATT, BATTERY	Battery	NMBR, NUM	Number
BX	Box (e.g. city box)	NONSUP	Non-Supervisory
CATE	Catastrophe	NORM, NRM	Normal
CDES, CODS, CDS	Codes	OUT	Output
CMPTR	Computer	OVRC	Overcurrent
COMM	Communicator	PAS	Positive Alarm Sequence
CONFIG	Configure	PHN, PHON	Phone
DESCRIPTION	Description	PROG, PRGMNG	Programming
DIG	Digit	PRGMMD	Programmed
DLY	Delay	PT, PNT	Point
DRL, DRIL	Drill	PWR	Power
D, DBL, DISABL	Disable	REM, REMOT	Remote
DSPLY	Display	RESPNS	Response
DTY	Dirty	RLY	Relay
EE	EEPROM	RPRT, RPT	Report
ERelay	Expander Relay	RST	Restore
EXP	Expander	SIL	Silence
FAIL	Failure	SMK	Smoke
F, FIR, FR	Fire	S, SUPERVISORY, SUP, SUPRVSRY, SUPV, SPV, SUPVSY	Supervisory
FLT	Fault	SHRT	Short
FRQNCY, FREQ, FREQUENCY	Frequency	SYS, SYSTM	System

Abbreviation	Definition	Abbreviation	Definition
FUNC	Function	T, TRBL, TRB, TROUB	Trouble
GRND	Ground	TST	Test
HI	High	VER	Version
HSTRY	History	W, WFLW, WTF	Waterflow
INIT	Initialize	ZN, ZON	Zone

Table 10.23: Abbreviations on control panel display

10.2 Appendix B: Panel Displays

The meanings of control panel messages are given in the following table:

Panel Display Message	Panel Display Message Definition (v1.06.01)
DBL PTXXX	Point is disabled from the keypad.
DTY PTXXX	A smoke detector with the Chamber Check feature indicates a dirty chamber.
INST.FLT 4Z EXP	There is a missing FPD-7034 Four Zone Expander Board, or the expander appeared unexpectedly since the last time the system was powered.
INST.FLT MX EXP	There is a missing MUX Expander Module, or the expander appeared unexpectedly since the last time the system was powered.
MUX X WIRE FAIL	A wiring short on Bus A or Bus B in Class B mode occurred. Check the wiring for shorts.
MUX CPU FAILURE	A CPU failure on the MUX Expander board occurred. Ensure that the Multiplex Expander module is correctly installed on the header pins. If the message persists, then call for service immediately.
MUX WIRING FAULT	A failure on the MUX wiring in Class A mode occurred. Check the wiring for opens. If an isolator is installed on the MUX bus, check for an activated condition.
REPROGRAM SYSTEM	An EEPROM failure occurred. Call for service immediately.
TRB PTXXX	Trouble condition for specific points on the system. Refer to the second line of display for more information. Check control panel wiring and field wiring for shorts or opens. Also check point programming to ensure the control panel knows what points belong on the system.
TRB SYS	General trouble message. Refer to second line of the display for more information.
TRBL OPEN NAC X	A Local NAC circuit is open. Check the field wiring and the EOL resistor.
TRBL OUTX RNACX	An FPP-RNAC-8A-4C Remote NAC circuit is open. Check the field wiring and the EOL resistor.

Panel Display Message	Panel Display Message Definition (v1.06.01)
TRBL OPT BUS@XX	A wiring fault on option bus terminals 7 to 14, 134 and 250, as well as specific address problems with option bus devices, occurred. Check the wiring for the specific device address shown.
TRBL OVRC NAC X TRBL OUTX RNACX	An over-current condition occurred on one of the NAC circuits. Check the field wiring on the notification appliances for shorts.
TRBL OUTX RNACX	A short on the FPP-RNAC-8A-4C Remote NAC circuit occurred.
TRBL SHRT NAC X	A short on the local NAC circuit (NAC 1 or NAC 2) occurred.
TROUBLE AC FAIL	AC power failure to the control panel. Check the circuit breaker or fuse for AC power problem.
TROUBLE CHARGER	The control panel's battery charger is not working.
TROUBLE COMM FLT	A communicator problem occurred. Check the control panel's phone lines and programming for the communicator problem.
TROUBLE GRND FLT	A ground fault problem occurred. Ensure that no control panel wiring is shorted to the earth ground.
TROUBLE LOW BATT	The voltage of the backup batteries is low or the backup batteries are missing.
TROUBLE PHONE X	A problem with the control panel's phone lines occurred. Check the phone wiring and line monitor programming.
TROUBLE SMK PWR	A short on the smoke power terminals SMK+ and SMK- occurred.

Table 10.24: Control panel display

10.3 Appendix C: Communicator Reporting Summary



Notice!

Information about the receiver output when the Modem IIIa² reporting format is used with a Bosch Security Systems, Inc. receiver is available in *Modem IIIa2 reporting*, page 116.



Notice!

When the Modem IIIa², SIA or Contact ID reporting formats are used, an additional numeric identifier is sent with system trouble messages that provide a specific indication of the particular fault. This identifier is also recorded in .

Fire communicator reporting summary

For report codes (Items in **boldface** type are not programmable), see the following table:

Report	Index	Default Values		Alternate Default		3/1	BFSK	SIA	Contact ID
		4/2 digit 1	4/2 digit 2	4/2 digit 1	4/2 digit 2				
POINT FIRE ALARM	0	0	p	0	p	0	z0	FAz	1 110 00 zzz
POINT WATERFLOW ALARM	1	0	p	0	p	0	z0	SAz	1 113 00 zzz

Report	Index	Default Values		Alternate Default		3/1	BFSK	SIA	Contact ID
		4/2 digit 1	4/2 digit 2	4/2 digit 1	4/2 digit 2				
POINT SUPERVISORY ALARM	2	0	p	0	p	0	z0	SSz	1 200 00 zzz
POINT MONITOR ALARM	3	0	p	0	p	0	z0	UAz	1 140 00 zzz
POINT FIRE TROUBLE	4	6	p	6	p	6	Fz	FTz	1 373 00 zzz
POINT WATERFLOW TROUBLE	5	see #4	p	see #4	p	see #4	Fz	STz	1 373 00 zzz
POINT SUPERVISORY TROUBLE	6	see #4	p	see #4	p	see #4	Fz	STz	1 373 00 zzz
POINT MONITOR TROUBLE	7	see #4	p	see #4	p	see #4	Fz	UTz	1 373 00 zzz
POINT FIRE DIRTY	8	see #4	p	see #4	p	see #4	Fz	FSz	1 385 00 zzz
POINT WATERFLOW DIRTY	9	see #4	p	see #4	p	see #4	Fz	FSz	1 385 00 zzz
POINT SUPERVISORY DIRTY	10	see #4	p	see #4	p	see #4	Fz	FSz	1 385 00 zzz
POINT MONITOR DIRTY	11	see #4	p	see #4	p	see #4	Fz	UTz	1 373 00 zzz
POINT FIRE DISABLE	12	B	p	5	p	B	Fz	FBz	1 571 00 zzz
POINT WATERFLOW DISABLE	13	see #12	p	see #12	p	see #12	Fz	FBz	1 571 00 zzz
POINT SUPERVISORY DISABLE	14	see #12	p	see #12	p	see #12	Fz	FBz	1 571 00 zzz
POINT MONITOR DISABLE	15	see #12	p	see #12	p	see #12	Fz	FBz	1 571 00 zzz
POINT FIRE ALARM RESTORE	16	3	p	2	p	3	Ez	FRz	3 110 00 zzz
POINT WATERFLOW RESTORE	17	see #16	P	see #16	P	see #16	Ez	SHz	3 113 00 zzz
POINT SUPERVISORY RESTORE	18	see #16	P	see #16	P	see #16	Ez	SRz	3 200 00 zzz
POINT MONITOR RESTORE	19	see #16	p	see #16	p	see #16	Ez	URz	3 140 00 zzz
POINT FIRE TROUBLE RESTORE	20	3	p	7	p	3	Ez	FJz	3 373 00 zzz
POINT WATERFLOW TROUBLE RESTORE	21	see #20	p	see #20	p	see #20	Ez	SJz	3 373 00 zzz

Report	Index	Default Values		Alternate Default		3/1	BFSK	SIA	Contact ID
		4/2 digit 1	4/2 digit 2	4/2 digit 1	4/2 digit 2				
POINT SUPERVISORY TROUBLE RESTORE	22	see #20	p	see #20	p	see #20	Ez	SJz	3 373 00 zzz
POINT MONITOR TROUBLE RESTORE	23	see #20	p	see #20	p	see #20	Ez	UJz	3 373 00 zzz
POINT FIRE DIRTY RESTORE	24	see #20	p	see #20	p	see #20	Ez	FJz	3 385 00 zzz
POINT WATERFLOW DIRTY RESTORE	25	see #20	p	see #20	p	see #20	Ez	FJz	3 385 00 zzz
POINT SUPERVISORY DIRTY RESTORE	26	see #20	p	see #20	p	see #20	Ez	FJz	3 385 00 zzz
POINT MONITOR DIRTY RESTORE	27	see #20	p	see #20	p	see #20	Ez	UJz	3 373 00 zzz
POINT FIRE DISABLE RESTORE	28	3	p	2	p	3	Ez	FHz	3 571 00 zzz
POINT WATERFLOW DISABLE RESTORE	29	see #28	p	see #28	p	see #28	Ez	FHz	3 571 00 zzz
POINT SUPERVISORY DISABLE RESTORE	30	see #28	p	see #28	p	see #28	Ez	FHz	3 571 00 zzz
POINT MONITOR DISABLE RESTORE	31	see #28	p	see #28	p	see #28	Ez	FHz	3 571 00 zzz
SYSTEM IN TEST	40	F	1	3	3	F	FD	TS0	1 607 00 000
SYSTEM IN TEST RESTORE	41	E	1	3	7	E	ED	TE0	3 607 00 000
SILENCE	42	9	F	9	F	9	FD	KB000	1 400 00 uuu
FIRE DRILL	43	F	2	3	3	F	FD	FI0	1 607 00 000
FIRE DRILL RESTORE	44	E	2	3	7	E	ED	FK0	3 607 00 000
SYSTEM RESET	45	9	F	9	F	9	FD	OR	1 305 00 uuu
LOW BATTERY	46	F	9	6	9	F	F9	YT0	1 302 00 000
LOW BATTERY RESTORE	47	E	9	7	9	E	E9	YR0	3 302 00 000

Report	Index	Default Values		Alternate Default		3/1	BFSK	SIA	Contact ID
		4/2 digit 1	4/2 digit 2	4/2 digit 1	4/2 digit 2				
AC FAIL	48	F	D	6	0	F	FD	AT0	1 301 00 000
AC FAIL RESTORE	49	E	D	7	0	E	ED	AR0	3 301 00 000
AUTO TEST	50	E	E	3	0	E	EE	RP0	1 602 00 000
OFF NORMAL AT TEST	51	F	D	3	3	F	FD	YX0	1 608 00 000
PHONE 1 TROUBLE	52	F	B	3	1	F	FB	LT1	1 351 00 000
PHONE 1 RESTORE	53	E	B	3	5	E	EB	LR1	3 351 00 000
PHONE 2 TROUBLE	54	F	C	3	2	F	FC	LT2	1 352 00 000
PHONE 2 RESTORE	55	E	C	3	6	E	EC	LR2	3 352 00 000
SYSTEM TROUBLE	56	F	D	3	3	F	FD	ET	1 300 00 ccc
SYSTEM TROUBLE RESTORE	57	E	D	3	7	E	ED	ER	3 300 00 ccc
MANUAL TEST	58	see #50	see #50	see #50	see #50	see #50	EE	RX0	1 601 00 000
COMM. FAULT	59	see #56	see #56	see #56	see #56	see #56	FD	RT0	1 354 00 000
EEPROM FAILURE	60	see #56	see #56	see #56	see #56	see #56	FD	UT18	1 307 00 018
EEPROM RESTORAL	61	see #57	see #57	see #57	see #57	see #57	ED	UJ18	3 307 00 018
SMOKE POWER FAULT	62	see #56	see #56	see #56	see #56	see #56	FD	YP0	1 320 00 000
SMOKE POWER RESTORE	63	see #57	see #57	see #57	see #57	see #57	ED	YQ0	3 320 00 000
REMOTE PROGRAMMING FAIL	66	F	D	F	D	F	FD	RU0	1 413 00 000
REMOTE PROGRAMMING SUCCESS	67	E	D	E	D	E	ED	RS0	1 412 00 000

Report	Index	Default Values		Alternate Default		3/1	BFSK	SIA	Contact ID
		4/2 digit 1	4/2 digit 2	4/2 digit 1	4/2 digit 2				

Notes:
 c: system trouble condition code
 p: programmable digit for each zone u: user ID digit
 z: zone digit

Modem IIIa2 reporting



Notice!

The Modem IIIa² reports are fixed and do not require programming.

Report	Index	Receiver output
POINT FIRE ALARM	0	dd/dd tt:tt ql ACCT aaaa FIRE ALARM +++ ACCT aaaa AREA=1 POINT=zzz
POINT WATERFLOW ALARM	1	dd/dd tt:tt ql ACCT aaaa FIRE ALARM +++ ACCT aaaa AREA=1 POINT=zzz
POINT SUPERVISORY ALARM	2	dd/dd tt:tt ql ACCT aaaa FIRE SUPRVISION +++ ACCT aaaa AREA=1 POINT=zzz
POINT MONITOR ALARM	3	dd/dd tt:tt ql ACCT aaaa FIRE ALARM +++ ACCT aaaa AREA=1 POINT=zzz
POINT FIRE TROUBLE	4	dd/dd tt:tt ql ACCT aaaa FIRE TROUBLE +++ ACCT aaaa AREA=1 POINT=zzz
POINT WATERFLOW TROUBLE	5	dd/dd tt:tt ql ACCT aaaa FIRE TROUBLE +++ ACCT aaaa AREA=1 POINT=zzz
POINT SUPERVISORY TROUBLE	6	dd/dd tt:tt ql ACCT aaaa FIRE TROUBLE +++ ACCT aaaa AREA=1 POINT=zzz
POINT MONITOR TROUBLE	7	dd/dd tt:tt ql ACCT aaaa FIRE TROUBLE +++ ACCT aaaa AREA=0 POINT=zzz
POINT FIRE DIRTY	8	dd/dd tt:tt ql ACCT aaaa ANALOG SERVICE +++ ACCT aaaa AREA=0 POINT=zzz
POINT WATERFLOW DIRTY	9	dd/dd tt:tt ql ACCT aaaa ANALOG SERVICE +++ ACCT aaaa AREA=1 POINT=zzz
POINT SUPERVISORY DIRTY	10	dd/dd tt:tt ql ACCT aaaa ANALOG SERVICE +++ ACCT aaaa AREA=1 POINT=zzz
POINT MONITOR DIRTY	11	dd/dd tt:tt ql ACCT aaaa FIRE TROUBLE +++ ACCT aaaa AREA=1 POINT=zzz
POINT FIRE DISABLE	12	dd/dd tt:tt ql ACCT aaaa COMMAND BYPASS +++ ACCT aaaa AREA=1 ID=uuu POINT=zzz

Report	Index	Receiver output
POINT WATERFLOW DISABLE	13	dd/dd tt:tt ql ACCT aaaa COMMAND BYPASS +++ ACCT aaaa AREA=1 ID=uuu POINT=zzz
POINT SUPERVISORY DISABLE	14	dd/dd tt:tt ql ACCT aaaa COMMAND BYPASS +++ ACCT aaaa AREA=1 ID=uuu POINT=zzz
POINT MONITOR DISABLE	15	dd/dd tt:tt ql ACCT aaaa COMMAND BYPASS +++ ACCT aaaa AREA=1 ID=uuu POINT=zzz
POINT FIRE ALARM RESTORE	16	dd/dd tt:tt ql ACCT aaaa FIRE ALM RESTOR +++ ACCT aaaa AREA=1 POINT=zzz
POINT WATERFLOW RESTORE	17	dd/dd tt:tt ql ACCT aaaa FIRE ALM RESTOR +++ ACCT aaaa AREA=1 POINT=zzz
POINT SUPERVISORY RESTORE	18	dd/dd tt:tt ql ACCT aaaa FIRE ALM RESTOR +++ ACCT aaaa AREA=1 POINT=zzz
POINT MONITOR RESTORE	19	dd/dd tt:tt ql ACCT aaaa FIRE ALM RESTOR +++ ACCT aaaa AREA=1 POINT=zzz
POINT FIRE TROUBLE RESTORE	20	dd/dd tt:tt ql ACCT aaaa FIRE TBL RESTOR +++ ACCT aaaa AREA=1 POINT=zzz
POINT WATERFLOW TROUBLE RESTORE	21	dd/dd tt:tt ql ACCT aaaa FIRE TBL RESTOR +++ ACCT aaaa AREA=1 POINT=zzz
POINT SUPERVISORY TROUBLE RESTORE	22	dd/dd tt:tt ql ACCT aaaa FIRE TBL RESTOR +++ ACCT aaaa AREA=1 POINT=zzz
POINT MONITOR TROUBLE RESTORE	23	dd/dd tt:tt ql ACCT aaaa FIRE TBL RESTOR +++ ACCT aaaa AREA=1 POINT=zzz
POINT FIRE DIRTY RESTORE	24	dd/dd tt:tt ql ACCT aaaa ANALOG RESTORE +++ ACCT aaaa AREA=1 POINT=zzz
POINT WATERFLOW DIRTY RESTORE	25	dd/dd tt:tt ql ACCT aaaa ANALOG RESTORE +++ ACCT aaaa AREA=1 POINT=zzz
POINT SUPERVISORY DIRTY RESTORE	26	dd/dd tt:tt ql ACCT aaaa ANALOG RESTORE +++ ACCT aaaa AREA=1 POINT=zzz
POINT MONITOR DIRTY RESTORE	27	dd/dd tt:tt ql ACCT aaaa FIRE TBL RESTOR +++ ACCT aaaa AREA=1 POINT=zzz
POINT FIRE DISABLE RESTORE	28	dd/dd tt:tt ql ACCT aaaa FIRE TBL RESTOR +++ ACCT aaaa AREA=1 POINT=zzz
POINT WATERFLOW DISABLE RESTORE	29	dd/dd tt:tt ql ACCT aaaa FIRE TBL RESTOR +++ ACCT aaaa AREA=1 POINT=zzz
POINT SUPERVISORY DISABLE RESTORE	30	dd/dd tt:tt ql ACCT aaaa FIRE TBL RESTOR +++ ACCT aaaa AREA=1 POINT=zzz

Report	Index	Receiver output
POINT MONITOR DISABLE RESTORE	31	dd/dd tt:tt ql ACCT aaaa FIRE TBL RESTOR +++ ACCT aaaa AREA=1 POINT=zzz
SYSTEM IN TEST	40	dd/dd tt:tt ql ACCT aaaa WALK TEST START +++ ACCT aaaa AREA=1 ID=uuu
SYSTEM IN TEST RESTORE	41	dd/dd tt:tt ql ACCT aaaa WALK TEST END +++ ACCT aaaa AREA=1 ID=uuu
SILENCE	42	dd/dd tt:tt ql ACCT aaaa SENSOR RESET +++ ACCT aaaa AREA=0 ID=uuu RELAY#=001
FIRE DRILL	43	dd/dd tt:tt ql ACCT aaaa FIRE WALK START +++ ACCT aaaa AREA=1 ID=uuu
FIRE DRILL RESTORE	44	dd/dd tt:tt ql ACCT aaaa FIRE WALK END +++ ACCT aaaa AREA=1 ID=uuu
SYSTEM RESET	45	dd/dd tt:tt ql ACCT aaaa SENSOR RESET +++ ACCT aaaa AREA=1 ID=uuu RELAY#=002
LOW BATTERY	46	dd/dd tt:tt ql ACCT aaaa BATTERY LOW
LOW BATTERY RESTORE	47	dd/dd tt:tt ql ACCT aaaa BATTERY RESTORE
AC FAIL	48	dd/dd tt:tt ql ACCT aaaa AC FAILURE
AC FAIL RESTORE	49	dd/dd tt:tt ql ACCT aaaa AC RESTORAL
AUTO TEST	50	dd/dd tt:tt ql ACCT aaaa TEST REPORT
OFF NORMAL AT TEST	51	dd/dd tt:tt ql ACCT aaaa TEST-OFF NORMAL
PHONE 1 TROUBLE	52	dd/dd tt:tt ql ACCT aaaa PHONE LINE FAIL +++ ACCT aaaa PHONE LINE=1
PHONE 1 RESTORE	53	dd/dd tt:tt ql ACCT aaaa PHONE RESTORAL +++ ACCT aaaa PHONE LINE=1
PHONE 2 TROUBLE	54	dd/dd tt:tt ql ACCT aaaa PHONE LINE FAIL +++ ACCT aaaa PHONE LINE=2
PHONE 2 RESTORE	55	dd/dd tt:tt ql ACCT aaaa PHONE RESTORAL +++ ACCT aaaa PHONE LINE=2
SYSTEM TROUBLE	56	dd/dd tt:tt ql ACCT aaaa EQUIPMENT FAIL +++ ACCT aaaa SDI=001 COND=ccc
SYSTEM TROUBLE RESTORE	57	dd/dd tt:tt ql ACCT aaaa EQUIP RESTORAL +++ ACCT aaaa SDI=001 COND=ccc
MANUAL TEST	58	dd/dd tt:tt ql ACCT aaaa TEST REPORT
COMM. FAULT	59	dd/dd tt:tt ql ACCT aaaa COMM FAIL +++ ACCT aaaa PH#=1

Report	Index	Receiver output
EEPROM FAILURE	60	dd/dd tt:tt ql ACCT aaaa EQUIPMENT FAIL +++ ACCT aaaa SDI=001 COND=18
EEPROM RESTORAL	61	dd/dd tt:tt ql ACCT aaaa EQUIP RESTORAL +++ ACCT aaaa SDI=001 COND=18
SMOKE POWER FAULT	62	dd/dd tt:tt ql ACCT aaaa EQUIPMENT FAIL +++ ACCT aaaa SDI=001 COND=4
SMOKE POWER RESTORE	63	dd/dd tt:tt ql ACCT aaaa EQUIP RESTORAL +++ ACCT aaaa SDI=001 COND=4
REMOTE PROGRAMMING FAIL	66	dd/dd tt:tt ql ACCT aaaa RAM ACCESS FAIL
REMOTE PROGRAMMING SUCCESS	67	dd/dd tt:tt ql ACCT aaaa RAM ACCESS OK
Notes: dd/dd tt:tt: date and time aaaa: 10-digit account number ccc: numeric identifier uuu: user ID zzz: point		

History log

The following table provides event numbers and their condition as they appear in the history log.

Condition	System event	Condition	System event
Option bus device at address 1 failed	2	Class A wiring failure on MUX bus	53
Option bus device at address 2 failed	3	“MORE, SEE HISTORY”	54
Option bus device at address 3 failed	4	“MORE, SEE HISTORY”	55
Option bus device at address 4 failed	5	MUX module processor failure	56
Option bus device at address 5 failed	6	Remote NAC module 1, output 1 wiring fault	57
Option bus device at address 6 failed	7	Remote NAC module 1, output 2 wiring fault	58
Option bus device at address 7 failed	8	Remote NAC module 1, output 3 wiring fault	59
Option bus device at address 8 failed	9	Remote NAC module 1, output 4 wiring fault	60
Option bus device at address 9 failed	10	MUX bus A (9-128) hardware failure	61
Option bus device at address 10 failed	11	MUX bus B (129-255) hardware failure	62
Option bus device at address 11 failed	12	NAC 1 disabled by user	63
Option bus device at address 12 failed	13	NAC 2 disabled by user	64

Condition	System event	Condition	System event
Option bus device at address 13 failed	14	Remote NAC module 2, output 1 wiring fault	65
Option bus device at address 14 failed	15	Remote NAC module 2, output 2 wiring fault	66
Option bus device at address 134 failed	16	Remote NAC module 2, output 3 wiring fault	67
Option bus device at address 250 failed	17	Remote NAC module 2, output 4 wiring fault	68
Communication fault (Restoral data lost)	18	Remote NAC module 3, output 1 wiring fault	69
EEPROM failure	19	Remote NAC module 3, output 2 wiring fault	70
Battery charger failure	20	Remote NAC module 3, output 3 wiring fault	71
Ground fault- wiring short	21	Remote NAC module 3, output 4 wiring fault	72
NAC 1 open wiring	22	Remote NAC module 4, output 1 wiring fault	73
NAC 2 open wiring	23	Remote NAC module 4, output 2 wiring fault	74
Remote NAC module 1 AC failure	24	Remote NAC module 4, output 3 wiring fault	75
Remote NAC module 2 AC failure	25	Remote NAC module 4, output 4 wiring fault	76
Remote NAC module 3 AC failure	26	Remote NAC module 1, output 1 disabled by user	77
Remote NAC module 4 AC failure	27	Remote NAC module 1, output 2 disabled by user	78
NAC 1 shorted wiring	28	Remote NAC module 1, output 3 disabled by user	79
NAC 2 shorted wiring	29	Remote NAC module 1, output 4 disabled by user	80
Remote NAC module 1 ground fault-short	30	Remote NAC module 2, output 1 disabled by user	81
Remote NAC module 2 ground fault-short	31	Remote NAC module 2, output 2 disabled by user	82
Remote NAC module 3 ground fault-short	32	Remote NAC module 2, output 3 disabled by user	83

Condition	System event	Condition	System event
Remote NAC module 4 ground fault-short	33	Remote NAC module 2, output 4 disabled by user	84
NAC 1 overcurrent	34	Remote NAC module 3, output 1 disabled by user	85
NAC 2 overcurrent	35	Remote NAC module 3, output 2 disabled by user	86
Remote NAC module 1 low battery	36	Remote NAC module 3, output 3 disabled by user	87
Remote NAC module 2 low battery	37	Remote NAC module 3, output 4 disabled by user	88
Remote NAC module 3 low battery	38	Remote NAC module 4, output 1 disabled by user	89
Remote NAC module 4 low battery	39	Remote NAC module 4, output 2 disabled by user	90
TRBL IP1 Mod@ 250	40	Remote NAC module 4, output 3 disabled by user	91
Multiplex bus outputs disabled by user	46	Remote NAC module 4, output 4 disabled by user	92
Dialer disabled by user	47	Four zone expander installation fault	93
Relay 1 disabled by user	48	MUX (DS9341) expander installation fault	94
Relay 2 disabled by user	49	TRBL IP2 Mod@ 250	95
Relay 3 disabled by user	50	TRBL IP1 Mod@ 134	96
Remote relay module 1 disabled by user	51	TRBL IP2 Mod@ 134	97
Remote relay module 2 disabled by user	52		

10.4 Appendix D: Programming Defaults List

For program default settings, see the following tables:

PROG TIME

SYSTEM:	010107
AUTO TEST	
TEST TIME:	0200
TEST FREQ:	6 hr
DAYLIGHT SAV:	2-- enable

SECURITY

PINS	
------	--

PROGRAMMER:	9876
USERS:	User 1 = 1234
	User 2 = 0000

AUTHORITY

USER 1:	2
OTHERS:	0

PROG SYSTEM

TIMERS	
SMOKE RESET:	6 sec
AC FAIL DELAY:	6 hr
AUTO SILENCE:	0 min
DISPLAY RATE:	4x.25 = 1 sec
AC LINE SYNCH	2 (60 Hz)
OPTION BUS	
UPDATE BUS:	Queries option buses and updates list of connected devices.
SETUP KEYPAD:	0
PIN REQUIRED:	
LOCAL:	0-- No
REMOTE:	1-- Yes
NAC SIL MODE	1-- Audible only
REMOTE PGM	0-- disable

PROG INPUTS

POINT NUMBER	(1-4/5-8/9-255)
FUNCTION	Point Function 1 = 1
	Point Function 2 = 2
	Point Function 3 = 3
	Point Function 4 = 4
	Point Function 5 = 5
	Point Function 6 = 6
	Point Function 7 = 7
	Point Function 8 = 8
	Point Function 9 - 255 = 10
ALARM/TROUBLE:	Trouble On Open

OUTPUT ZONE	Point Zone 1 = 1
	Point Zone 2 = 2
	Point Zone 3 = 3
	Point Zone 4 = 4
	Point Zone 5 = 5
	Point Zone 6 = 6
	Point Zone 7 = 7
	Point Zone 8 = 8
	Point Zone 9 - 19 = 9
	Point Zone 20 - 39 = 10
	Point Zone 40 - 59 = 11 etc.
VERIFICATION:	No
LATCHING:	Yes

POINT FUNCTION (1-16)

	1-3, 5-10, 12-16	4	11
CONFIGURE	fire	water	supv
LOCAL ONLY	no	no	no
SILENCEABLE	no	no	no
LOOP REPSONSE	fast	16s	fast

PROG OUTPUTS

NACs	
NAC #1:	
CONFIGURATION:	Steady
ZONE ASSIGNS:	
Zone A:	53
Zone B:	61
Zone C:	0
Zone D:	0
NAC #2:	
CONFIGURATION:	Steady
ZONE ASSIGNS:	
Zone A:	53
Zone B:	61
Zone C:	0

NACs	
Zone D:	0

RNACs	
RNAC 1	
Outputs 1, 2, 3, 4	
Configuration:	Steady
Zone Assignment:	
Zone A:	53
Zone B:	0
Zone C:	0
Zone D:	0
RNAC 2	
Outputs 1, 2, 3, 4	
Configuration:	Steady
Zone Assignment:	
Zone A:	53
Zone B:	0
Zone C:	0
Zone D:	0
RNAC 3	
Outputs 1, 2, 3, 4	
Configuration:	Steady
Zone Assignment:	
Zone A:	53
Zone B:	0
Zone C:	0
Zone D:	0
RNAC 4	
Outputs 1, 2, 3, 4	
Configuration:	Steady
Zone Assignment	
Zone A:	53
Zone B:	0

RNACs	
Zone C:	0
Zone D:	0

RELAYS

LOCAL:	
RELAY #1	
Zone A:	63
Zone B:	0
Zone C:	0
Zone D:	0
RELAY #2	
Zone A:	62
Zone B:	0
Zone C:	0
Zone D:	0
RELAY #3	
Zone A:	58
Zone B:	0
Zone C:	0
Zone D:	0

REMOTE	
REMOTE 1 (D7035)	
Relay 1 / Zone A:	63
Relay 2 / Zone A:	62
Relay 3 / Zone A:	61
Relay 4 / Zone A:	60
Relay 5 / Zone A:	58
Relay 6 / Zone A:	57
Relay 7 / Zone A:	56
Relay 8 / Zone A:	53
REMOTE 2	
Relay 1 / Zone A:	1
Relay 2 / Zone A:	2

REMOTE	
Relay 3 / Zone A:	3
Relay 4 / Zone A:	4
Relay 5 / Zone A:	5
Relay 6 / Zone A:	6
Relay 7 / Zone A:	7
Relay 8 / Zone A:	8

PROG ACCOUNTS

PHONE NUMBERS	
PHONE 1, 2	
NUMBER/IP:	> (wait for dialtone)
FORMAT:	0-- Disable
ACCT NUMS:	0000000000
TONE:	1- 19D, 14A, 10PS
IP MOD PRIRY	1- @250 AS PRIM
PHONE CONTROL	1- PULSE ONLY
LINE 1, 2	
MONITOR:	No
DIALING TYPE:	Pulse Only

REPORT STEERING

ALL SUB-MENU ITEMS:	Phone 2 Back-up
RING COUNT:	00
COMM TRIES:	10
MACH BYPASS:	No
ALTER COMM	0

PROG FORMATS

4/2 ZONE REPORT	
0- FIRE ALRM D1:	0
1- FIRE RSTR D1:	3
2- WATERFLOW D1:	0
3- SUPERVISE D1:	0
4- TROUBLE D1:	6
5- TRBL RSTR D1:	3
6- DISABLE D1:	B

4/2 ZONE REPORT	
7- DSBL RSTR D1:	3
8- (reserved)	
9- MORE	
1- POINT 1 D2:	1
2- POINT 2 D2:	2
3- POINT 3 D2:	3
4- POINT 4 D2:	4
5- POINT 5 D2:	5
6- POINT 6 D2:	6
7- POINT 7 D2:	7
8- POINT 8 D2:	8
1- POINT 9 D2:	9
2- POINT 10 D2:	0

ALT 4/2 CODES	
SYSTEM IN TST:	F1
SYS TEST RST:	E1
SILENCE:	9F
FIRE DRILL:	F2
FIRE DRL RST:	E2
OPEN RST RPT:	9F
LOW BATTERY:	F9
LOW BATT RST:	E9
AC FAILURE:	FA
9- MORE	
ALT 4/2 CODES	
AC FAIL RST:	EA
TEST REPORT:	EE
OFF NORM TST:	FD
PHONE 1 TRBL:	FB
PN 1 TRB RST:	EB
PHONE 2 TRBL	FC

ALT 4/2 CODES	
PN 2 TRB RST:	EC
SYSTEM TROUB:	FD
SYS TRB RST:	ED

BFSK RPT CDS	
OFF NRM TST:	FD
OPEN/RESET:	FD
SILENCE:	FD
FIRE DRILL:	FD
FIR DRIL RSTR:	ED

HISTORY DEFAULTS

ALT 4/2 CODES

4/2 POINT REPORTS	
FIRE ALRM D1:	0
FIRE RSTR D1:	2
WATERFLOW D1:	0
SUPERVISE D1:	0
TROUBLE D1:	6
TRBL RSTR D1:	7
DISABLE D1:	5
DSBL RSTR D1:	2
MONITOR D1	0
POINT 1 D2:	1
POINT 2 D2:	2
POINT 3 D2:	3
POINT 4 D2:	4
POINT 5 D2:	5
POINT 6 D2:	6
POINT 7 D2:	7
POINT 8 D2:	8
POINT 9 D2:	9
POINT 10 D2:	0

4/2 RPT CODS	
SYSTEM IN TST:	33
SYS TEST RST:	37
SILENCE:	9F
FIRE DRILL:	33
FIRE DRL RST:	37
OPEN RST RPT:	9F
LOW BATTERY:	69
LOW BATT RST:	79
AC FAILURE:	60
AC FAIL RST:	70
TEST REPORT:	30
OFF NORM TST:	33
PHONE 1 TRBL:	31
PN 1 TRB RST:	35
PHONE 2 TRBL	32
PN 2 TRB RST:	36
SYSTEM TROUB:	33
SYS TRB RST:	37

Multiplex

MUX BUS TYPE:	2 CLASS B
---------------	-----------

10.5**Appendix E: Phone Monitor Troubleshooting****10.5.1****COMM FLT/DATA LOST**

A common cause of this fault condition is failing to program Phone/IP 2 or Account Number 2. While some reports are directed to Phone/IP 2, backup reports are still made to Phone/IP 1. This message warns the installer that Phone/IP 2 is not available if it is needed.

Other communications problems that can cause this condition include:

1. Events occurring faster than the dialer can send them, which overflows the 32 event buffer,
2. Programming errors such as missing phone numbers or account codes, over 100 Trouble reports in 24 hours, or
3. Other problems contacting a receiver.

Check dialing type, format selection, phone numbers, account codes, phone line condition and tone programming.

For more information, see *Communicator Operation*, page 57.

10.5.2

Trouble Phone

Some troubleshooting tips for phone monitor problems when using two phone lines are listed below:



Warning!

High voltage!

The voltage present during ringing for an incoming call can be over 100 VAC.

1. Use a voltmeter to measure the voltage present across each phone line (Tip to Ring) while the phone line is on-hook. This standby telco battery voltage is typically in the range of 30 VDC to 50 VDC, but any voltage above 5 VDC is accepted by the control panel. The polarity of the voltage does not matter.
2. Check for other devices that might use the phone line, such as fax machines, credit card verifiers or PBX systems. If the devices cannot be removed, then ensure that they are wired so that the control panel's line-seizure relay disconnects them when needed. Measure the line voltage while these devices are in use. Ensure that it stays above 5 V when off-hook.
3. Check for intermittent faults in the phone line. Make a test call and confirm that the line is free of distortion and noise. Temporarily swap Lines 1 and 2 on the control panel and check if the problem indication moves to the control panel's other phone line channel. If so, then the phone line is causing the problem rather than the line monitor.
4. Confirm that the fault message is phone fault and not com fault. Com fault is often caused by failing to program a phone number or account number for Phone Number 2 while routing reports to Line 1, Backup Line 2. If only one phone number is available for reporting, then set report direction for all events to phone 1 only. Com fault can also happen if one of the phone lines has telco battery voltage, but does not complete a call. Make test calls to the receiver(s) on both phone lines, listening for the receiver ACK tone.
5. Ensure that two phone lines are available. The Auto-test report is sent on a different phone line each time it is sent. If only one phone line is connected to the control panel, then a Com fault is generated on every other test call.

Bosch Security Systems, Inc.

130 Perinton Parkway
Fairport, NY 14450
USA

www.boschsecurity.com

© Bosch Security Systems, Inc., 2016

Bosch Sicherheitssysteme GmbH

Robert-Bosch-Ring 5
85630 Grasbrunn
Germany