

1 |

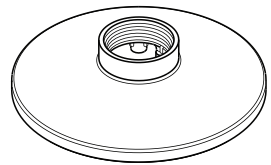

x1 M4x16mm x4 M6x12mm

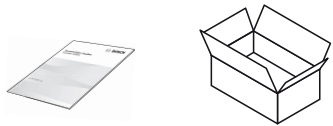

2 |

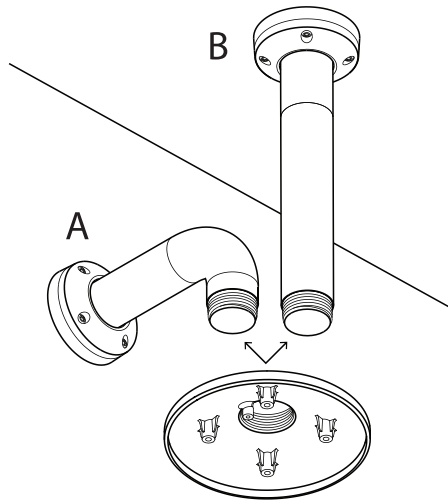

3 |

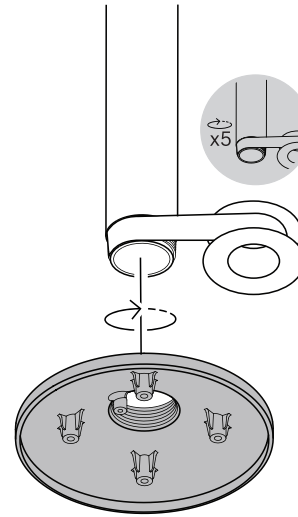

4 |

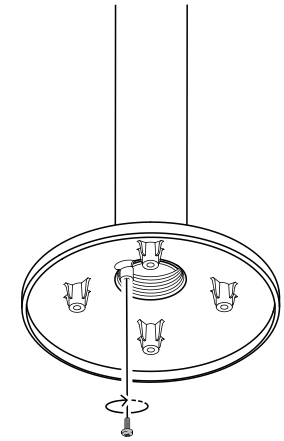

5 |

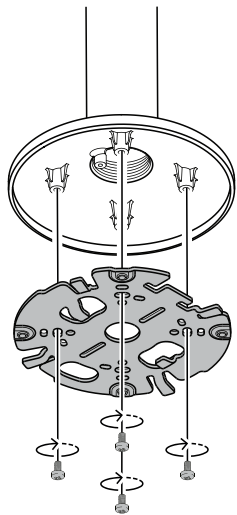

6 |

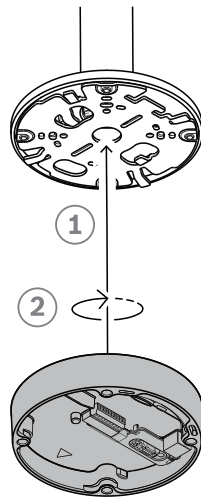

7 |

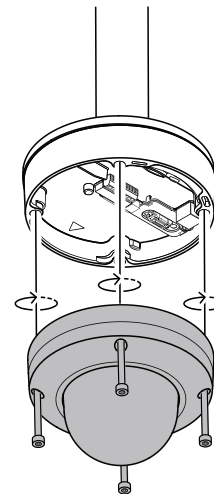

8 |

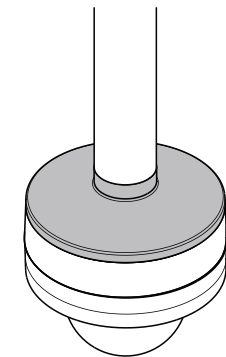

1 Safety

1.1 Safety precautions

Caution!



Installation should only be performed by qualified service personnel in accordance with the National Electrical Code (NEC 800 CEC Section 60) or applicable local codes.



Disposal - Your Bosch product was developed and manufactured with high-quality material and components that can be recycled and reused. This symbol means that electronic and electrical appliances, which have reached the end of their working life, must be collected and disposed of separately from household waste material. Separate collecting systems are usually in place for disused electronic and electrical products. Please dispose of these units at an environmentally compatible recycling facility, per European Directive 2012/19/EU.

1 Sicherheit

1.1 Sicherheitsvorkehrungen

Vorsicht!



Die Installation darf nur von qualifiziertem Kundendienstpersonal gemäß den jeweils zutreffenden Elektrovorschriften ausgeführt werden.



Entsorgung: Bei der Entwicklung und Fertigung Ihres Bosch Produkts wurden hochwertige Materialien und Bauteile eingesetzt, die wiederaufbereitet und wiederverwendet werden können. Dieses Symbol weist darauf hin, dass Elektro- und Elektronikgeräte am Ende ihrer Lebensdauer getrennt vom Hausmüll gesammelt und entsorgt werden müssen. Für elektrische und elektronische Altgeräte gibt es in der Regel gesonderte Sammelstellen. Geben Sie diese Geräte gemäß der Europäischen Richtlinie 2012/19/EU bei einer entsprechenden Entsorgungseinrichtung ab.

1 Sécurité

1.1 Consignes de sécurité

Attention!



L'installation doit exclusivement être réalisée par du personnel qualifié, conformément au code national d'électricité américain (NEC) ou au code d'électricité local en vigueur.



Mise au rebut - Votre produit Bosch a été conçu et fabriqué à partir de matériaux et de composants recyclables et réutilisables de haute qualité. Ce symbole signifie que les appareils électriques et électroniques en fin de vie doivent être mis au rebut séparément du reste des ordures ménagères. Des services de collecte séparés sont généralement mis en place pour les produits électriques et électroniques. Veuillez mettre au rebut ces appareils dans un centre de recyclage respectueux de l'environnement, conformément à la Directive européenne 2012/19/UE.



BOSCH

Pendant interface plate, indoor

NDA-8000-PIP

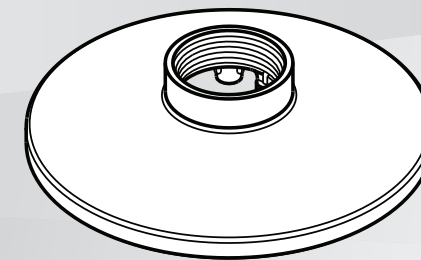

en Quick Installation Guide

1 安全

1.1 安全预防措施

小心!



安装须由合格的维修人员遵照国家电工标准或当地的相关电气规则进行。



回收处理 - 博世产品采用高品质的材料和组件进行开发和制造,可以回收利用。该符号表示在电气和电子设备达到其使用寿命期限时,应与生活垃圾分开收集处理。通常有专门的回收机构来处理废旧的电气和电子产品。请通过符合欧盟 2012/19/EU 标准的环保回收机构来处理本设备。

Bosch Security Systems B.V.
Torenallee 49
5617 BA Eindhoven
The Netherlands
www.boschsecurity.com
© Bosch Security Systems B.V., 2019