

LTC9412/00



Security Systems

EN

Installation Manual
Indoor Pendant Mount Dome

BOSCH

Table of Contents

1	DESCRIPTION.....	2
2	UNPACKING.....	2
3	SERVICE.....	2
4	INSTALLATION.....	2
5	EXPLODED VIEW.....	3

1 DESCRIPTION

The LTC9412/00 is a 12" pendant mount ceiling dome for indoor applications. The housing top is black ABS plastic

2 UNPACKING

Unpack carefully. This is a mechanical equipment and should be handled carefully.

Check for the following items:

- Model No. of unit

If an item appears to have been damaged in shipment, replace it properly in its carton and notify the shipper. If any items are missing, notify your Bosch CSS Sales Representative or Customer Service.

The shipping carton is the safest container in which the unit may be transported. Save it for possible future use.

3 SERVICE

If the unit ever needs repair service, the customer should contact the nearest Bosch Security Systems Service Center for authorization to return and shipping instructions.

Service Centers

U.S.A.: Phone: 800-366-2283 or 408-956-3895
 fax: 800-366-1329 or 408-956-3896
 e-mail: NationalServiceCenter@ca.slr.com

Canada: 514-738-2434

Europe, Middle East & Asia Pacific Regions:
 32-1-440-0711

For additional information, see www.boschsecuritysystems.com

4 INSTALLATION

This installation should be made by qualified service personnel and conform to the National Electrical Code and applicable local codes.



Please read these instructions carefully before proceeding, and heed all cautions.

- 4.1. Remove contents from the box and check to be sure all pieces are included.
- 4.2. Select the desired location for the installation. It must be a secure mounting structure, and the completed installation must be able to support 3 times its weight.
- 4.3. Determine the desired height for the unit. Measure from the ceiling to the top of the housing (the housing is approximately 18" tall). Add 8" for the interior of the LTC9412. Obtain 1/2" electrical conduit and hardware to mount to the ceiling. Cut the conduit to the measured length. Mount the conduit to the ceiling.
- 4.4. Slide the Clamp Connector and housing up the conduit so that the end of the conduit is approximately level with the bottom of the housing. Tighten the 2 Phillips head screws (Figure 1).

Clamp connector
with 2 Phillips head
screws

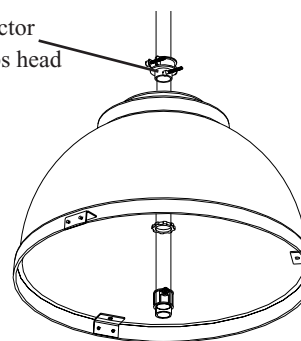

Figure 1 Slide housing and connector onto conduit

- 4.5. Completely seat the EMT connector to the end of the conduit and tighten the set screw (Figure 2).

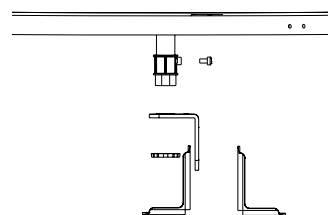

Figure 2 Place the EMT connector on the conduit

- 4.6. Remove the set screw and drill an approximately 7/32" hole at the point where the set screw dimples the conduit. Remove the burrs and replace the set screw.
- 4.7. Attach the longer arm of the camera bracket to the end of EMT connector using the clamp nut. Tighten (Figure 3).

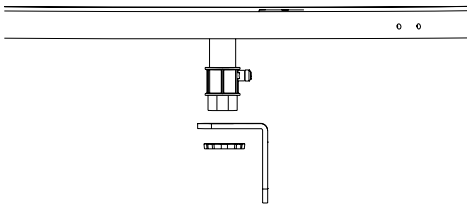

Figure 3 Attach bracket arm to EMT connector

- 4.8. Attach the other bracket arm using a carriage bolt, 5/16" washer, lockwasher, and hex nut. The camera mounting side may be facing either in or out (Figure 4).

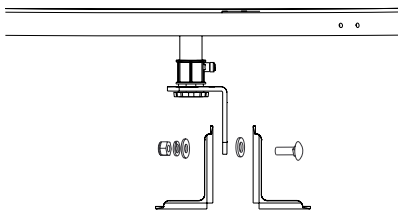

Figure 4 Attach other bracket arm

- 4.9. Connect the camera to the camera bracket and adjust to desired viewing position. Tighten all connections. Complete wiring of the camera.
- 4.10. Place the liner inside the dome. Hold the dome and liner up to the housing and align the 3 Hartwell Fasteners in the dome to the matching holes on the housing. Ensure that the cutout in the liner is aligned with the camera. Once it's correctly positioned attach the dome to the housing by pressing the Hartwell Fasteners into the flange of the dome (Figure 5).

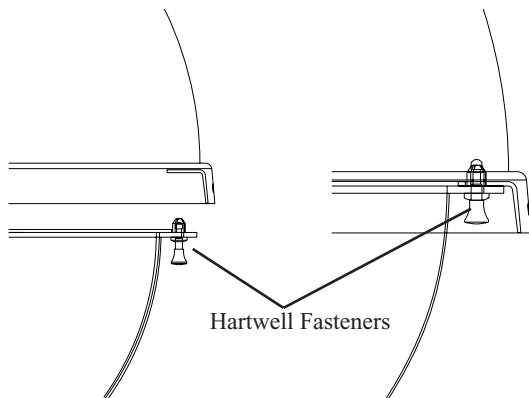
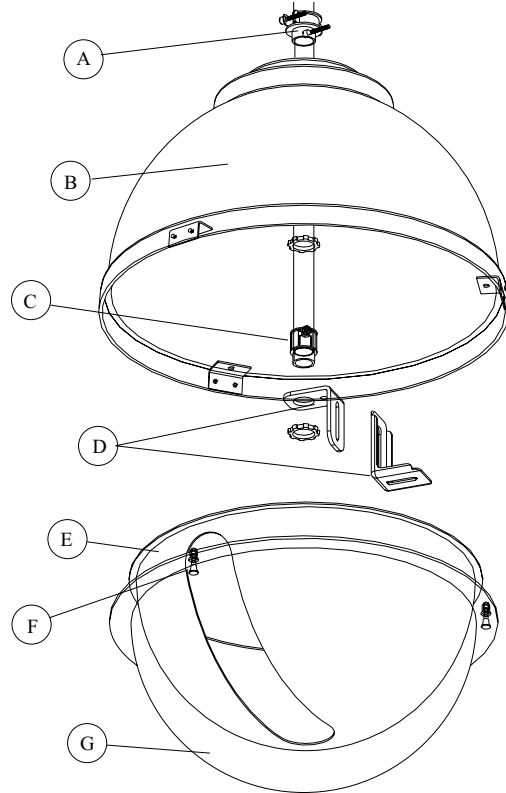
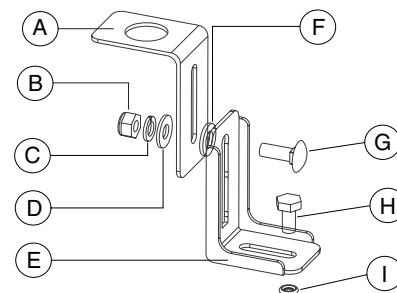

Figure 5 Attach the dome to the housing

5 EXPLODED VIEW



	Description	Part number	Qty.
A	Clamp connector	70-WPCR02	1
B	12" ABS housing (black)	21-TOP123	1
C	EMT connector	70-WPCR01	1
D	Camera bracket	30-VL1361	1
E	12" dome liner	20-LNOP123	1
F	Hartwell fastener	95-FSPLO1(2)	3
G	12" OP clear dome	RCOP123	1



	Description	Qty.
A	VL1361 bracket	1
B	1/4-20 hex nut	1
C	1/4" split lockwasher	1
D	1/4" flat washer	1
E	FM2 bracket	1
F	5/16" washer	1
G	1/4-20 x 3/4" carriage bolt	1
H	1/4-20 x 1/2" hex bolt	1

Bosch Security Systems, Inc.
850 Greenfield Road
Lancaster, PA 17601 EE.UU.
Tel: 800-326-3270
Fax: 1-717-735-6560
www.boschsecuritysystems.com

Robert Bosch GmbH
Geschäftsbereich
Postfach 10 60 50
70049 Stuttgart
Telefax (07 11) 8 11-12 34

Bosch Security Systems B.V.
P.O. Box 80002
5600 JB Eindhoven
The Netherlands
Tele +31 40 27 80000

© 2003 Bosch Security Systems GmbH
3935 890 15611 | 14 November 2003 | Data subject to change without notice.

BOSCH