

PAVIRO Call Station Kit

PVA-CSK



BOSCH

en Operation manual

Table of contents

1	Safety notes	4
2	Brief description	6
3	System overview	7
4	Parts included	8
5	Installation	9
5.1	Mainboard	9
5.2	Delivery condition	10
6	Activation	12
6.1	Connecting LEDs	12
6.2	Connecting buttons	12
6.3	Call station bus port	12
6.4	LINE port	13
6.5	Microphone/PTT port	13
7	Configuration	15
7.1	CAN address	15
7.2	CAN baud rate	15
7.3	CAN termination	16
7.4	Microphone type	16
8	Operation	17
8.1	Indicators	17
8.2	LC display	18
8.3	Functions	19
9	Maintenance	22
10	Technical data	23
10.1	Block diagram	25
10.2	Dimensions	26

1 Safety notes



WARNING: TO REDUCE THE RISK OF FIRE OR ELECTRIC SHOCK, DO NOT EXPOSE THIS APPLIANCE TO RAIN OR MOISTURE.
AVIS: RISQUÉ DE CHOC ÉLECTRIQUE - NE PAS OUVRIR

CAUTION: TO REDUCE THE RISK OF ELECTRIC SHOCK, GROUNDING OF THE CENTRE PIN OF THIS PLUG MUST BE MAINTAINED.

THIS DEVICE COMPLIES WITH PART 15 OF THE FCC RULES. OPERATION IS SUBJECT TO THE FOLLOWING TWO CONDITIONS:
 (1) THIS DEVICE MAY NOT CAUSE HARMFUL INTERFERENCE AND (2) THIS DEVICE MUST ACCEPT ANY INTERFERENCE RECEIVED, INCLUDING INTERFERENCE THAT MAY CAUSE UNDESIRE OPERATION.



Danger!

The lightning symbol inside a triangle notifies the user of high-voltage, uninsulated lines and contacts inside the devices that could result in fatal electrocution if touched.



Warning!

An exclamation mark inside a triangle refers the user to important operating and service instructions in the documentation for the equipment.

1. Read these safety notes.
2. Keep these safety notes in a safe place.
3. Heed all warnings.
4. Observe all instructions.
5. Do not operate the device in close proximity to water.
6. Use only a dry cloth to clean the unit.
7. Do not cover any ventilation slots. Always refer to the manufacturer's instructions when installing the device.
8. Do not install the device close to heaters, ovens, or other heat sources.
9. Note: The device must only be operated via the mains power supply with a safety ground connector. Do not disable the safety ground connection function of the supplied power cable. If the plug of the supplied cable does not fit your mains socket, please contact your electrician.
10. Ensure that it is not possible to stand on the mains cable. Take precautions to ensure the mains cable cannot become crushed, particularly near the device connector and mains plug.
11. Only use accessories/extensions for the device that have been approved by the manufacturer.
12. Unplug the device if there is risk of lightning strike or in the event of long periods of inactivity. However, this does not apply if the device is to be used as part of an evacuation system!
13. Have all service work and repairs performed by a trained customer service technician only. Service work must be carried out immediately following any damage such as damage to the mains cable or plug, if fluid or any object enters the device, if the device has been used in rain or become wet, or if the device has been dropped or no longer works correctly.
14. Please ensure that no dripping water or spray can penetrate the inside of the device. Do not place any objects filled with fluids, such as vases or drinking vessels, on top of the device.
15. To ensure the device is completely free of voltage, unplug the device from the power supply.
16. When installing the device, ensure that the plug is freely accessible.
17. Do not place any sources of open flame, such as lit candles, on top of the device.

18. This PROTECTION CLASS I device must be connected to a MAINS socket with a safety ground connection.



Caution!

Use only manufacturer-approved carts, stands, brackets, or tables that you acquired together with the device. When using carts to move the device, make sure the transported equipment and the cart itself cannot tip over or cause injury or material damage.

IMPORTANT SERVICE INFORMATION



Caution!

This service information is for use by qualified service personnel only. To avoid the risk of electric shock, do not perform any maintenance work that is not described in the operating instructions unless you are qualified to do so. Have all service work and repairs performed by a trained customer service technician.

1. Repair work on the device must comply with the safety standards specified in EN 60065 (VDE 0860).
2. A mains isolating transformer must be used during any work for which the opened device is connected to and operated with mains voltage.
3. The device must be free of any voltage before performing any alterations with upgrade sets, switching the mains voltage, or performing any other modifications.
4. The minimum distance between voltage-carrying parts and metal parts that can be touched (such as the metal housing) or between mains poles is 3 mm, and must be observed at all times.
5. The minimum distance between voltage-carrying parts and circuit parts that are not connected to the mains (secondary) is 6 mm, and must be observed at all times.
6. Special components that are marked with the safety symbol in the circuit diagram (note) must only be replaced with original parts.
7. Unauthorized changes to the circuitry are prohibited.
8. The protective measures issued by the relevant trade organizations and applicable at the place of repair must be observed. This includes the properties and configuration of the workplace.
9. Observe the guidelines with respect to handling MOS components.



Danger!

SAFETY COMPONENT (MUST BE REPLACED BY ORIGINAL PART)

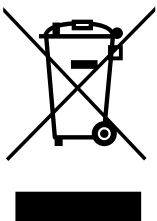

Old electrical and electronic appliances

Electrical or electronic devices that are no longer serviceable must be collected separately and sent for environmentally compatible recycling (in accordance with the European Waste Electrical and Electronic Equipment Directive).

To dispose of old electrical or electronic devices, you should use the return and collection systems put in place in the country concerned.

2 Brief description

The PVA-CSK call station kit is a call station printed circuit board (PCB) for the PAVIRO system. The circuit board allows an application-specific call station to be installed, such as a fire department call station.

The call station kit is based on the call station, but has been optimized so that it is easy to adapt to different application areas. In addition to the stem microphone familiar from the PVA-15CST, a dynamic EMERGENCY microphone such as the DBB 9081 can also be connected. The call station kit equipped with an illuminated LC display (122 x 32 pixels). The call station has the following features:

- Possible to connect microphone with pre-amplifier and compressor/limiting switch
- Possible to connect five pre-programmed menu/function buttons
- Possible to connect up to 15 function and selection buttons, programmable button assignment
- Possible to connect up to three alarm buttons or key switches
- Possible to connect an external microphone or audio source
- Possible to connect a loudspeaker
- High-resolution LC display
- Comprehensive parameter settings menu on the actual call station
- Microphone and line monitoring
- Error message via LED and buzzer, and error text in the LC display
- Processor control of all functions
- Monitoring of the processor system via watchdog circuit
- Non-volatile FLASH memory for configuration data

The call station is processor-controlled, and equipped with extensive monitoring functions. Line monitoring for the CAN bus and for audio transmission allows line interruptions and short-circuits to be detected and indicated to the user. The microphone, PTT button, alarm button and key switch monitoring allows line interruptions and short-circuits to be detected and reported.

The call stations for the PAVIRO system can be configured quickly and easily using IRIS-Net. A graphical and dialog-based user interface allows the user to define all button functions, priorities, options, and other properties.

3 **System overview**

See the "Brief description" and "Installation" sections.

4 Parts included

Number	Component
1	PVA-CSK printed circuit board
1	PVA-CSK display
1	Connection cable for display (50 cm)
10	Euroblock connector 10-pole (Phoenix, MC 1,5/10-STF-3,81, 1803659, F.01U.241.148)
1	Euroblock connector 2-pole (Dinkle, EC381V-02P, F.01U.066.918)
1	Operation manual
1	Important safety instructions

Table 4.1: PMX-CSK Scope of Delivery

5 Installation

5.1 Mainboard

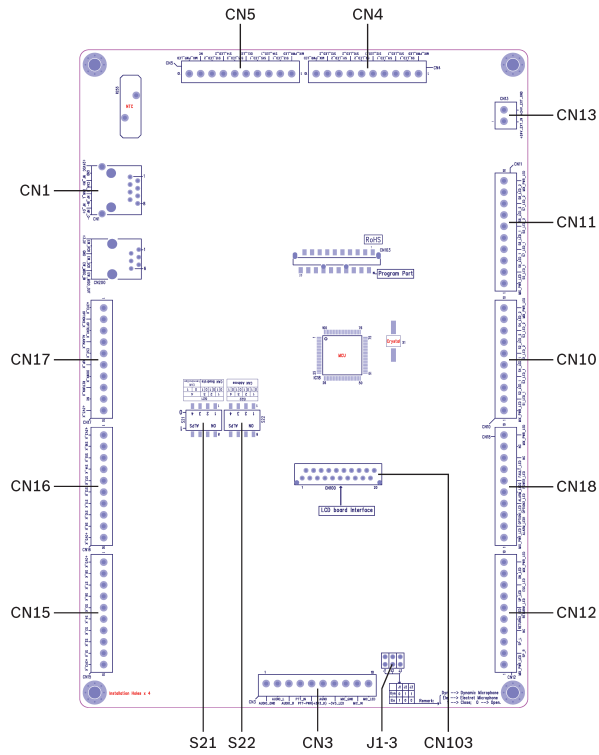

Figure 5.1: PMX-CSK mainboard, numbered

Number	Element	Description (default setting)
CN1	Call station bus port	Connection for PAVIRO controller
CN3	MIC/LINE/PTT port	Connection for <ul style="list-style-type: none"> - External audio source - External microphone - Microphone LED - PTT button - PTT LED
CN4	Interface for status LEDs 9–12	Connection for LED_1 or LED_2 for buttons 9–12
CN5	Interface for status LEDs 13-15	Connection for LED_1 or LED_2 for buttons 13–15
CN10	Interface for status LEDs 1-4	Connection for LED_1 or LED_2 for buttons 1–4
CN11	Interface for status LEDs 5-8	Connection LED_1 or LED_2 for buttons 5–8
CN12	Interface for menu LEDs and loudspeaker	Connection for LEDs for the UP, DOWN and ESC buttons and loudspeaker (SP_R, SP_L) for playback of signal tones

Number	Element	Description (default setting)
CN13	+24V input	With a 24-V power supply, the PVA-CSK is operated with 24 V instead of 3.3 V. This means 24-V lighting can be connected.
CN15	Interface for buttons 1–8	Connection for circuit selection and group selection buttons 1–8
CN16	Interface for buttons 9–15 and menu button	Connection for circuit selection and group selection buttons 9–15 and DEL button (selection of all zones and groups)
CN17	Interface for menu and alarm buttons	<ul style="list-style-type: none"> – Menu buttons: See <i>Delivery condition</i>, page 10 – Alarm buttons: Connection for up to 3 alarm buttons or key switches
CN18	Interface for POWER, ALARM and FAULT LED	<ul style="list-style-type: none"> – POWER LED: Illuminates when the power supply is on – ALARM LED: Illuminates when an alarm is active – FAULT LED: Illuminates when an error occurs
CN103	Display port	The status of the call station or overall PAVIRO system is shown on the display along with any errors. The display is connected using the supplied ribbon cable
S21	CAN baud rates and terminating switch	See <i>CAN baud rate</i> , page 15 or <i>CAN termination</i> , page 16
S22	CAN address switch	See <i>CAN address</i> , page 15
J1-3	Jumper for microphone type selection	See <i>Microphone type</i> , page 16

5.2 Delivery condition

The selection buttons S1–15 are already assigned to circuits 1–15 by default. The menu, navigation, and function buttons (CN17 and contact S16_K of CN16) are also preconfigured. As such, the call station kit is ready for operation once it has been connected.



Warning!

If multiple call stations or call station kits need to be operated via a PAVIRO controller, each device must be assigned a unique CAN address (1–16). Subsequently changing the CAN address causes the configuration to change.

The call stations are programmed with the following factory functions and properties settings:

Parameters		Setting/description
CAN address		0 (disconnected)
CAN baud rate		10 kbps
CAN termination		Not activated
Priority		5 (priority for audio message)
Name		PVA-CSK
Password		Setup menu password-protected, default password: 2222
Pre chime		Off
Buzzer		On (acoustic warning signal)
Compressor		Off
Options	Alarm buttons	Not configured
	Key switch	Not configured
	PTT microphone	Not configured
Button assignment	S1–15_K from CN15 and CN16	Selection buttons for circuits 1 to 15 (button 1 = circuit 1, button 2 = circuit 2, etc.)
	RETURN_K, CN17	Call in selected circuits, priority 5
	UP_K, CN17	Switches system on/off, priority 5
	DOWN_K, CN17	Program assignment to selected circuits
	ESC_K, CN17	Stop for all locally triggered signals (chime, text, alarm)
	S16_K, CN16	Selects all-call/deletes call pattern
Special functions		Not configured
Microphone type		Dynamic microphone

6 Activation

This chapter describes how to connect buttons and LEDs to the call station kit.

6.1 Connecting LEDs

LEDs can be connected to the PVA-CSK directly, i.e. without series resistance. The MIX_PWR_LED pin is available at both ends of the LED connector plug (e.g. CN11) to supply the LEDs with power.

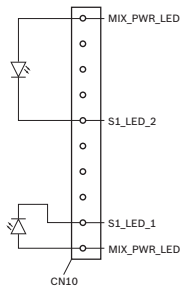

Figure 6.1: Connecting LED_1 or LED_2 of the S1_K selection button



Notice!

Power supply voltage

If no voltage supply is connected to CN13, the PVA-CSK is powered via the PAVIRO controller. In this case, a voltage of 5 V is supplied to the MIX_PWR_LED pin. By connecting a 24 V supply voltage to CN13, the voltage to all MIX_PWR_LED pins increases to 24 V. This means 24 V lighting can be connected.

6.2 Connecting buttons

Buttons can be connected to the call station kit directly, i.e. without series resistance. The +3V3_K pin is available at both ends of the button connector plug (e.g. CN17) to supply the power.

6.3 Call station bus port

The call station bus port is used to connect the call station kit (or the call station) to a PAVIRO system. This is an 8-pin RJ-45 port that is assigned the power supply, control interface (CAN bus), and audio interface.



Notice!

For CAN, AUDIO IN, and AUDIO OUT, the wires must be twisted pairs in each case.

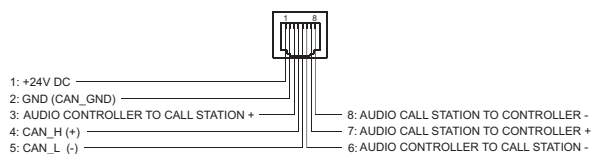

Figure 6.2: Assignment of the bus post

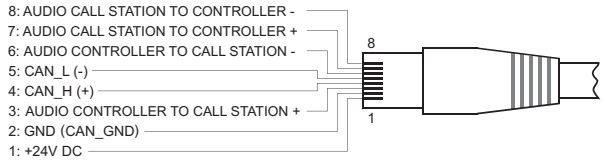

Figure 6.3: Assignment of the bus plug

For general information about the structure of a CAN bus, see section CAN bus basics. If only call stations or call station kits are connected to a call station bus, deviations from the true bus structure are possible if line type 4x2x0.8 J-Y(St)Y is used. Any topology with 1 or 2 terminating resistors can be established at a CAN baud rate of 20 kbit/s or less; in this case, the maximum wire length for CAN or audio is 1000 meters. The required wire cross section for mains power supply must be checked separately.

6.4 LINE port

The AUDIO_GND, AUDIO_L and AUDIO_R contacts of CN3 allow an external audio device (e.g. a CD player) to be connected. If configured in IRIS-Net, the audio source connected to this interface can be used for a program in the PAVIRO system. A connected stereo signal is automatically converted into a mono signal.

6.5 Microphone/PTT port



Notice!

Adjust the setting of jumpers J1–3 to the microphone type used, see *Microphone type*, page 16.

The following diagram shows how to connect a microphone to the call station kit. A standard electret microphone ($V_{cc} = 3.3\text{ V}$) can be used. An LED can be connected to the MIC_LED and -3V3_LED contacts of CN3 to monitor the status of the microphone input (active/not active).

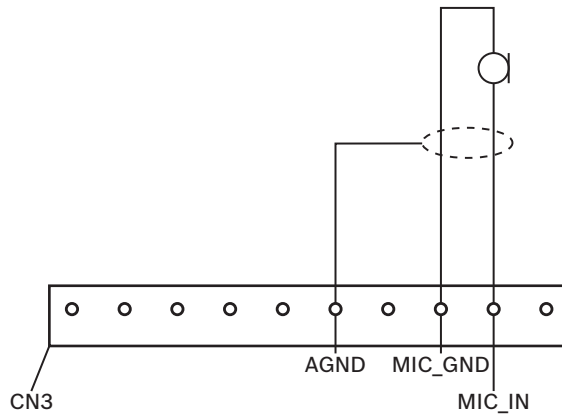

Figure 6.4: Connecting a microphone

The PTT_IN contact of CN3 is used to connect a monitored PTT microphone (e.g. DBB 9081/00). The PTT function is configured in IRIS-Net. The following diagram shows how to connect a DBB 9081/00 to the PVA-CSK .

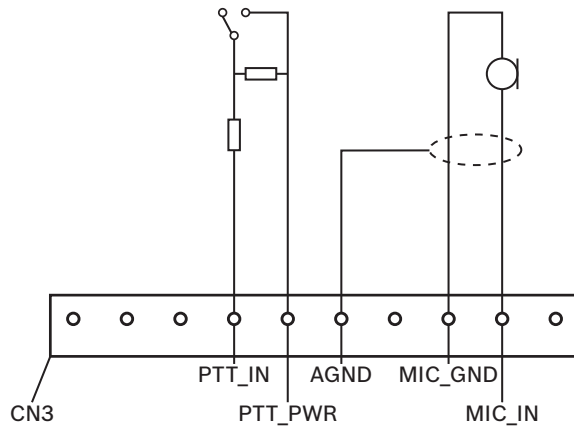

Figure 6.5: Connecting a PTT microphone

7 Configuration

7.1 CAN address

DIP switch S22 is used to set the CAN address. See the following table.

DIP switch S22				CAN address
4	3	2	1	
0	0	0	0	0 (default)
0	0	0	1	1
0	0	1	0	2
0	0	1	1	3
0	1	0	0	4
0	1	0	1	5
0	1	1	0	6
0	1	1	1	7
1	0	0	0	8
1	0	0	1	9
1	0	1	0	10
1	0	1	1	11
1	1	0	0	12
1	1	0	1	13
1	1	1	0	14
1	1	1	1	15

Table 7.1: Setting the CAN address via DIP switch S22 (0 = OFF, 1 = ON)

7.2 CAN baud rate

DIP switch S21 is used to set the CAN baud rate. See the following table.

DIP switch S21			Baud rate in kbps
3	2	1	
x	0	0	10 (default)
x	0	1	20
x	1	x	62.5

Table 7.2: Setting the CAN baud rate via DIP switch S21 (0 = OFF, 1 = ON, x = any)

7.3 CAN termination

At the end of the call station bus bus, the CAN bus must be terminated with a terminating resistor. The terminating resistor integrated in the PVA-CSK for this purpose can be activated via DIP switch S21. See the following table.

DIP switch S21		Terminating resistor
4	3-1	
0	See baud rate setting	Not active , i.e. bus not terminated (default)
1		Active, i.e. bus terminated

Table 7.3: Activating the terminating resistor via DIP switch S21 (0 = OFF, 1 = ON)

7.4 Microphone type

Jumpers J1–3 are used to adjust the call station kit to the connected microphone type. See the following table.

Jumpers J1–3			Microphone type
3	2	1	
x	1	1	Dynamic microphone (default)
1	0	0	Electret microphone

Table 7.4: Setting the microphone type via jumpers J1–3 (0 = open, 1 = closed, x = any)

8 Operation

8.1 Indicators

The meanings of the call station LED indicators are summarized below. Standard configuration of the call station is assumed.

LED	Status	Description
Sx_LED_1	Off	Circuit or group not selected
	Illuminated	<ul style="list-style-type: none"> - Circuit or group selected - Special function activated - Direct call activated
Sx_LED_2	Off	The audio signal transmitted has a priority below the VAC priority
	Illuminated	The audio signal transmitted has a priority equal or above the VAC priority.
UP_LED	Off	System is switched off (standby)
	Illuminated	System is switched on and ready for operation
	Flashing	System has been switched on and is booting up (activation process)
DN_LED	Off	Call station in announcement mode or menu mode
	Illuminated	Call station in program assignment mode
ESC_LED	Off	Pressing the button does not do anything – the action cannot be stopped
	Illuminated	Pressing the button ends an event that has already started
DEL_LED	Off	No all-call selected
	Illuminated	All-call pre-selection
RETURN_LED	Off	The selected circuits are free and a call can be made
	Illuminated while the RETURN_K button is depressed	The announcement is being transmitted
	Flashing slowly	A call station with lower priority is currently transmitting an announcement in at least one selected circuit – this announcement can be interrupted at the expense of the currently active call station

LED	Status	Description
	Flashing rapidly	At least one of the selected circuits is occupied with higher priority (announcement, chime, alarm) and cannot be interrupted. A call that has already started will be interrupted by the higher priority
POWER_LED	Off	The call station power supply has been deactivated/interrupted.
	Illuminated	The call station power supply is functioning correctly.
FAULT_LED	Off	System is running smoothly
	Illuminated	There is an error in the PAVIRO system – details are displayed in the LC display
	Flashing	There is a new, as yet unconfirmed error in the PAVIRO system – details are displayed in the LC display
ALARM_LED	Off	No alarm started
	Illuminated	The alarm was triggered by any station
	Flashing	The alarm has already been stopped, but is running until the end of the signal

8.2 LC display

Depending on the current status of the system, the illuminated LC display with 122 x 32 pixels shows time information, operating states, user information, setup information, error messages with precise device/module descriptions, and so on.

Status display in the LC display

During normal operation in announcement mode, the name of the call station (line 1) and the date and time (line 2) are displayed in the LC display.

Error display in the LC display

If an error occurs in the PAVIRO system, this is displayed on the call station as follows:

- The FAULT_LED flashes, and a signal tone is sounded via the built-in loudspeaker
 - The error is displayed in the LC display
 - Pressing the ESC_K button confirms the error message, and deactivates the signal tone. At the same time, the FAULT_LED switches from flashing to permanently illuminated. If a new error occurs, confirmation is required once again
 - The FAULT_LED signals an error in the PAVIRO system for as long as the error is present
- The error display and signal tone must be configured via the configuration in IRIS-Net.

8.3 Functions

After being switched on, the call station will be in announcement mode. The menu mode is used to configure the call station.

Button	Announcement mode	Menu mode
UP_K	This button switches the system on and off. The activation process may take a few seconds. As soon as the system is ready for operation, the UP_LED illuminates. To prevent operating errors, press and hold the button for at least three seconds when activating or deactivating the system. The button can be locked via configuration in IRIS-Net.	This button is used to scroll up when navigating through the menu.
ESC_K	Pressing this button confirms a new error and disables the signal tone at the same time.	When navigating through the menu, this button acts as the ESC button, i.e. canceling an action or returning to a higher-level menu.
DOWN_K	Pressing this button stops a live audio signal (chime, alarm, text). The precise function can be configured in the IRIS-Net software.	This button is used to scroll down when navigating through the menu.
S16_K	This button is used to select all circuits for announcements, chime/alarm signals, speech reproduction, or program assignment. Pressing the button once selects all circuits, and the corresponding S16_LED_1 and the DEL_LED illuminate. Pressing the button again deletes the entire selection. The following options can be selected in IRIS-Net: <ul style="list-style-type: none"> - Switch between "Select All" and "Delete All" - Select All - Delete All 	The button acts as the backspace key for numerical entries.

Button	Announcement mode	Menu mode
RETURN_K	This button is used to activate an announcement in selected circuits or groups. The precise function of the RETURN_LED is described in section Indicators . The toggle mode can be programmed optionally.	When navigating through the menu, the button is used to confirm an entry or select a selected entry.
Sx_K (selection buttons)	There are 15 selection buttons with corresponding LEDs. These are used to select individual circuits or groups for announcements, chime/alarm signals, speech reproduction, or program assignment (press once = on, press again = off). The LEDs show the current selection status (see section Indicators). The buttons can also be assigned a special function or no function (no assignment). The functions are assigned when configuring via a PC.	Entering numbers

Selection call

The user can make an announcement in freely selectable circuits or groups. Confirming one or more selection buttons selects the circuits or groups in which the announcement is to be made. The corresponding LED_1 illuminate. A line that has already been selected can be disabled again by pressing the corresponding selection button again, and the relevant LED_1 switches off. If the LED_2 of an Sx_K selection button has not switched off, the corresponding zone/group is not free (see section Indicators).

Once the selection has been made, the call is started by pressing the RETURN_K button. Prior to this, the RETURN_LED indicates whether all lines or the call station input are free. If individual lines or the input is occupied by a lower-priority event, the RETURN_LED flashes slowly. An announcement can still be made, but this will interrupt another event. If individual lines or the input is occupied by a higher-priority event, the RETURN_LED flashes quickly, and the call request is ignored (see the description in Indicators).

During the announcement, the RETURN_LED illuminates. The RETURN_K button must be held down until the end of the announcement.

The RETURN_LED starts to flash if a user is interrupted by an event with higher priority. In this case, the announcement must be repeated.

After releasing the RETURN_K button, the selection remains until the next change. Pressing the S16_K button twice deletes the entire selection.

All-call

The announcement is made in all system circuits. The procedure is the same as for the selection call. First, all system circuits are selected by pressing the S16_K button. Pressing the RETURN_K button activates the all-call. The LED_1 for all existing circuit or group buttons and the DEL-LED illuminate during the call (see section Indicators). The RETURN_K button must be held down until the end of the announcement. The RETURN_LED acts in the same way as for the selection call.

General alarm



Notice!

The alarm trigger does not depend on the priority of the call station from which the alarm is activated. The user can configure the call stations from which an alarm may be triggered. If configured, an alarm can also be triggered if the system is in standby mode. A visual and possibly also acoustic signal is sent to each call station in the system to indicate that an alarm is active.

Alarm buttons can be configured in such a way that an alarm signal is transmitted to all lines. A general alarm signal is transmitted to all lines in the system. Pressing the ALARM_K button triggers the alarm. The corresponding ALARM_LED illuminates during the alarm. An alarm has high priority and takes precedence over all announcements or signals except for actions that are triggered from the central station.

Pressing the DOWN_K button switches the alarm off again.

Selection alarm



Notice!

The alarm trigger does not depend on the priority of the call station from which the alarm is activated. The user can configure the call stations from which an alarm may be triggered. If configured, an alarm can also be triggered if the system is in standby mode. A visual and possibly also acoustic signal is sent to each call station in the system to indicate that an alarm is active.

Alarm buttons can be configured in such a way that an alarm signal is only transmitted to certain lines that have been previously selected. As with the selection call, the circuits/groups to which an alarm is to be transmitted must first be selected. The ALARM_K button must then be pressed. The corresponding ALARM_LED illuminates during the alarm. The lines for the next alarm can now be selected.

Pressing the DOWN_K button switches the alarm off again.

Stopping signals

Pressing the DOWN_K button stops a current alarm or chime, or cancels speech playback. The function of the DOWN_K button (priority, local events etc.) can be configured in IRIS-Net. One exception is the central station (call station with the highest priority), which can cancel any signals.

System on/off

The PAVIRO system can be switched on or off with the UP_K button. Normally, this is not possible from any call station. For this reason, this function can be programmed via IRIS-Net. In deactivated mode (standby), the corresponding LED is off. Pressing the UP_K button switches on the PAVIRO system. During the activation process, the UP_LED flashes, and when the system is ready for operation, the UP_LED remains illuminated (applies to all call stations in the system).

To switch off the system, the UP_K button must be pressed and held down for approx. three seconds. This prevents unintentional deactivation if the button is pressed accidentally.

The PAVIRO system can also be switched on and booted up automatically from an external location by pressing the ALARM_K button or triggering an alarm sequence.

Special functions

Each of the selection buttons on the call station can be assigned a special function. This means a call station can also be used as an input terminal to control lighting, door openers, window blinds, and so on. The volume levels can also be controlled via the Up/Down buttons. More information on this topic can be found in the IRIS-Net documentation.

9 Maintenance

The PVA-CSK does not require maintenance.

10 Technical data

Buttons (through screw-terminal connectors)	<p>5 pre-programmed 15 programmable zone/function buttons 3 supervised programmable optional emergency buttons 2 connections for each button; 23 buttons share 6 common VCCs (3V3 - DC) Each button has short circuit protection</p>
LEDs connected to buttons (through screw-terminal connectors)	<p>PVA-CSK supports open drain outputs with max. 5 mA per output. Using the internal supply, a maximum of 100 mA can be sourced for all outputs. The PVA-CSK also provides an external power supply for lighting LEDs of external normal buttons. 2 connections (VCC & open collector) are available for each LED connected to a button. In total, 38 LEDs share 10 common MIX_PWR_LED. These LEDs are supplied with 5 V DC using the internal power supply. The connected LEDs are supplied with 24 V DC using the external power supply. Each LED circuit has short-circuit protection.</p>
Power LED (through screw-terminal connectors)	<p>Driven by MIX_PWR_LED (5 V DC or 24 V DC) 2 connections (VCC & open collector)</p>
Fault LED (through screw-terminal connectors)	<p>Driven by MIX_PWR_LED (5 V DC or 24 V DC) 2 connections (VCC & open collector)</p>
Alarm LED (through screw-terminal connectors)	<p>Driven by MIX_PWR_LED (5 V DC or 24 V DC) 2 connections (VCC & open collector)</p>
Included LCD display kit	<p>A flat ribbon cable connects the display to the call station kit mainboard. The ribbon cable length is +/- 300 mm</p>
Others (through screw-terminal connectors)	<p>1 audio source (line in) 1 supervised microphone input (DBB 9081/00) capsule and PTT button connection (input & VCC) with short-circuit protection. 1 loudspeaker connection, 1 additional +24 V DC power supply</p>
External connectors	<p>1 call station bus connector (control data + audio + power supply, RJ-45) 1 EXT connector (RJ-12, e.g. for call station extension)</p>
Main power supply	
– Nominal voltage	24 V DC (-10%/+30%)

– Maximum voltage range	15–58 V DC
Nominal current consumption for main power supply	< 100 mA
Maximum supply current	
– External power supply for lighting, without extensions	< 80 mA/24 V < 110 mA/18 V
– Internal power supply for lighting, without extensions	< 150 mA/24 V < 200 mA/18 V
CAN interface	10, 20, or 62.5 kbit/s
Maximum mic input level	-21 dBu
Maximum line input level	+4 dBu
NF output	Balanced
– Nominal level	+6 dBu
– Maximum level	+12 dBu
Frequency response	200–16,000 Hz, +0/-3 dB
Signal-to-noise ratio (Mic and Line input, NF output)	≥ 60 dB
Buttons	
– Nominal voltage	3.3 V DC
– Max current	100 mA
PTT input switch	
– Nominal voltage	3.3 V DC
– Max current	100 mA
LEDs	
– Nominal drive current	5 mA for each LED
– Maximum drive current	20 mA for each LED
– Nominal drive voltage	– 5 V by internal power supply for 5-V point lighting LEDs – 24 V by external power supply for 24-V ring lighting LEDs
Additional power supply for industrial buttons backlight	
– Nominal voltage	24 V DC (-10/+30%)
– Nominal current consumption	< 300 mA
– Maximum supply current	< 500 mA at 24 V
External speaker	

- Nominal resistance	8 Ω
- Power rating	1.5 W
- Maximum power	2 W
- Nominal operating voltage	3.5 V
Normal microphone (DBB 9081/00 reference)	
- Sensitivity	3.1 mV/Pa ±4 dB
- Frequency response	280–14000 Hz
- Rated output impedance	500 Ω
- Polar pattern	Omnidirectional
- Switch	On/off with remote control contact

10.1 Block diagram

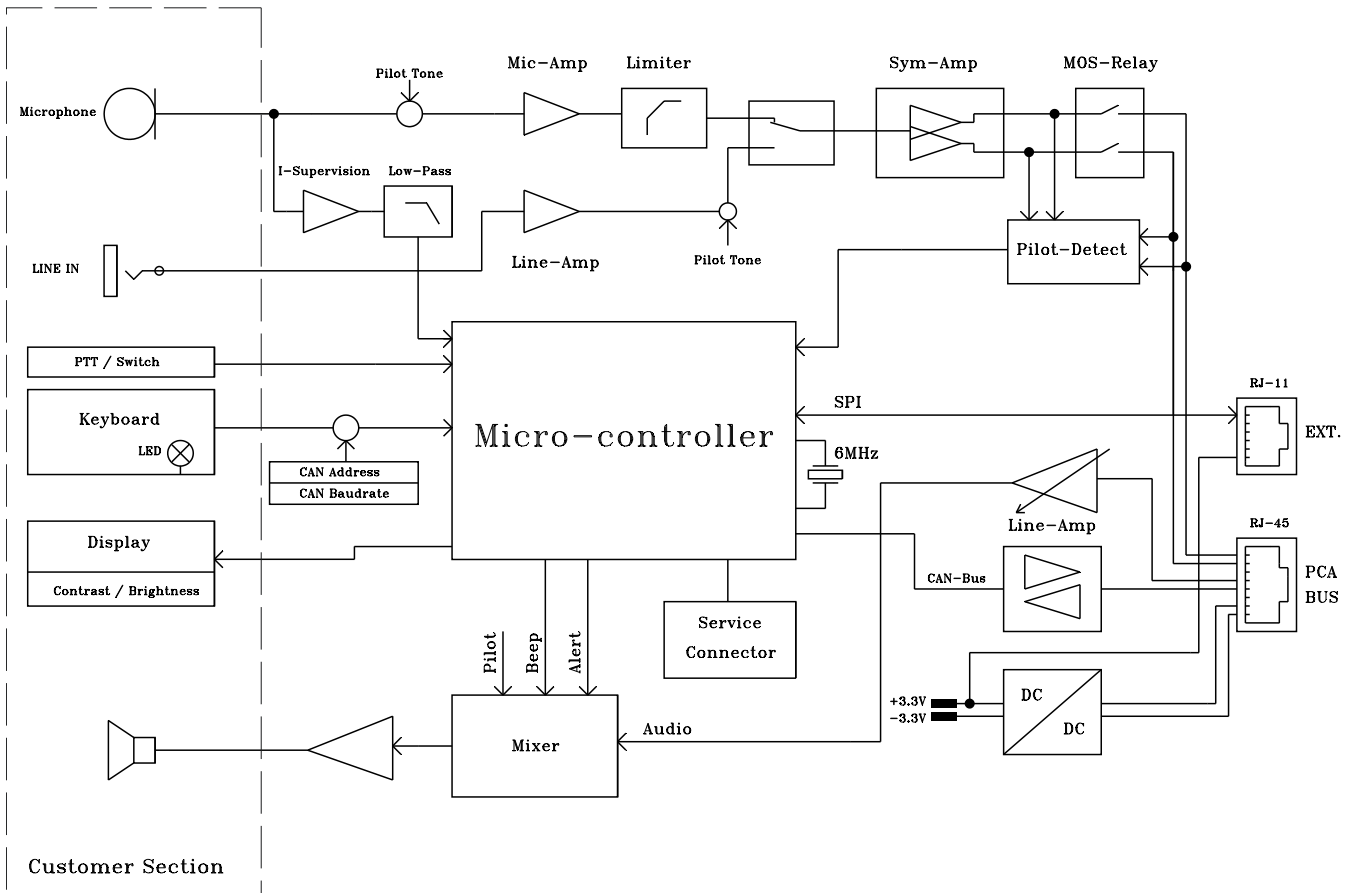

10.2 Dimensions

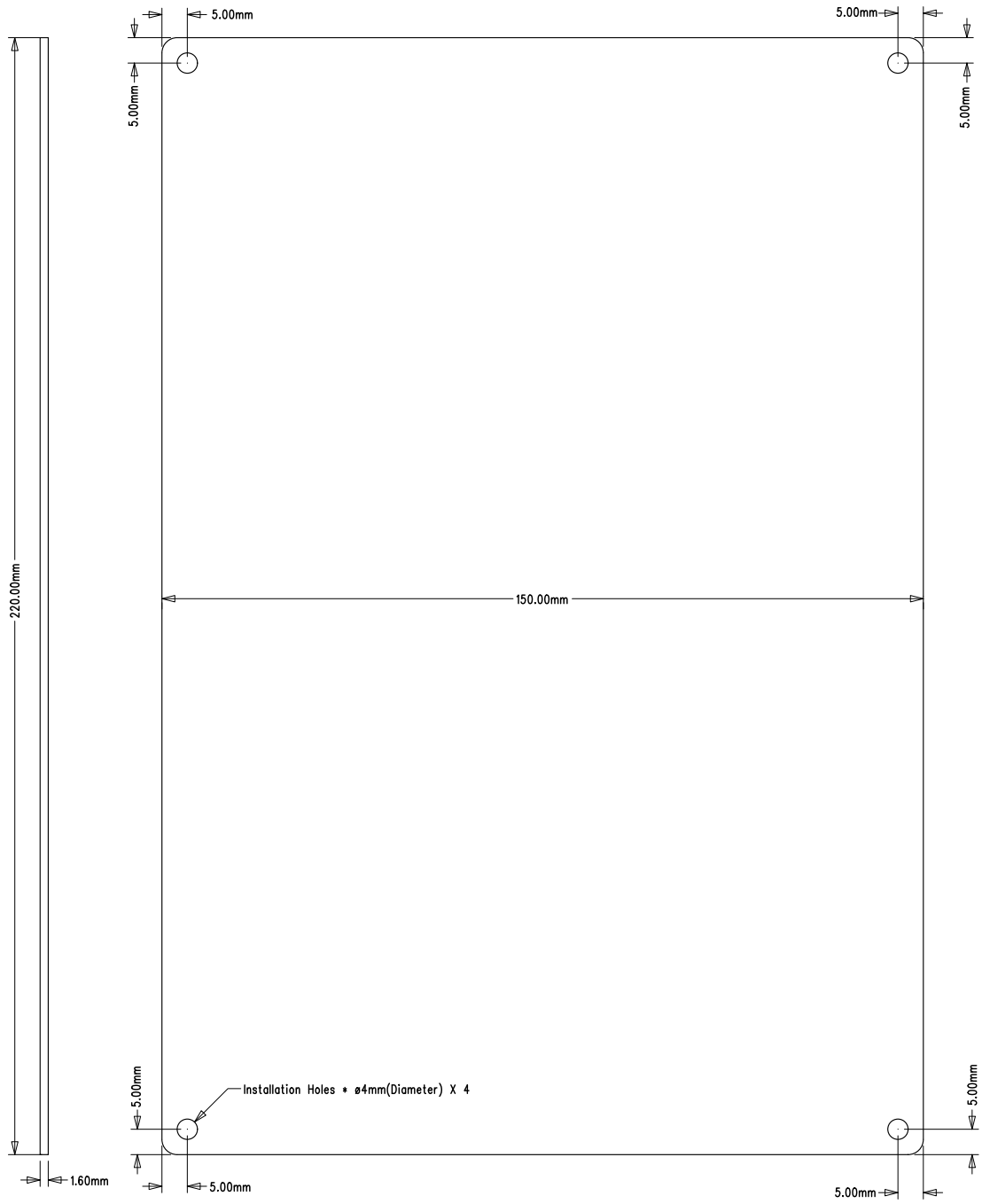

Figure 10.1: Dimensions of mainboard

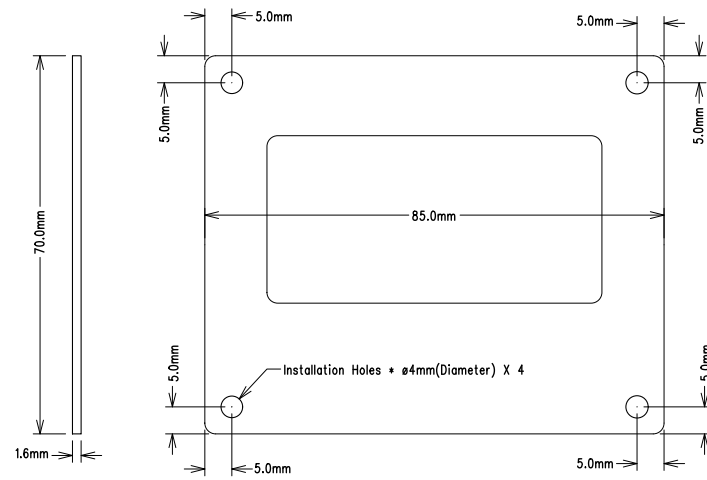

Figure 10.2: Dimensions of LCD board

Bosch Security Systems B.V.

Torenallee 49

5617 BA Eindhoven

The Netherlands

www.boschsecurity.com

© Bosch Security Systems B.V., 2015