

## PRA-SCS System controller, small

### PRAESENSA



The small system controller PRA-SCS is the budget variant in the range of PRAESENSA system controllers. The small controller has all the features of the large system controller PRA-SCL except for some limitations regarding the size of the system. The system controller manages all system related functions in a PRAESENSA Public Address and Voice Alarm system. It routes all audio connections between network-connected PRAESENSA audio sources and destinations. It supervises and plays back messages and tones, stored on its flash memory, either scheduled or manually started from a call station or PC. It manages the routing of background music streams, along with business calls and emergency calls, all based on priority level and zone occupancy. It collects all status information of connected system devices, manages the event logs and reports faults.

The system controller is network-connected via OMNEO and DC-powered from a multifunction power supply with integrated battery backup, accommodating both centralized and decentralized system topologies. Connections to other devices in the system are made using the built-in 5-port switch, supporting RSTP. The built-in web server allows for system configuration using a browser.

#### Functions

##### System control and audio routing

- Capability to control PRAESENSA systems with a maximum of six amplifiers. In combination with the PRA-AD608 amplifiers, the PRA-SCS is sufficient to control up to 48 zones. Use the PRA-SCL to address more zones or if you need more power.

- ▶ Full control of PRAESENSA devices and audio routing
- ▶ Built-in supervised storage for messages and tone files
- ▶ Support for Dante audio input and output streams
- ▶ Open interface to third party applications
- ▶ IP-networked on OMNEO for audio and control

- The number of dynamic OMNEO channels that can be routed is unlimited, which allows for many simultaneous calls. However, the number of static Dante audio streams to use as interface with 3<sup>rd</sup> party systems is limited to eight.
- Native support for switched single-subnet networks, with add-on support for routed multi-subnet topologies.
- Dynamic allocation of multiple and simultaneous audio channels to save on network bandwidth; audio connections are created when a call or a message is broadcast, and freed up immediately afterwards.
- Secure interconnections using Advanced Encryption Standard (AES128) for audio data and Transport Layer Security (TLS) for control data.
- Receiver for up to eight Dante or AES67 audio channels from external sources, with dynamic re-routing to secure OMNEO channels.
- SIP/VoIP interface for telephone paging and for audio to PRAESENSA and control from 3<sup>rd</sup> party systems.
- Internal storage capacity for messages and tones; up to eight messages can be played back simultaneously.
- Internal real time clock for scheduled events and event time stamping; support for Network Time Protocol (NTP) with automatic adjustment for Daylight Saving Time (DST).
- Internal system event and fault event log.
- Networked control interface for third party applications.
- Built-in webserver for configuration and file management using a browser.

- Dual redundant system controller option for highest system availability in mission-critical applications.
- When equipped with the PRA-LSCRF License call recording and forwarding, eight recorders and players allow for call stacking and time-shifting.

**Sound quality**

- Audio-over-IP, using OMNEO, the Bosch high-quality digital audio interface, compatible with Dante and AES67; audio sample rate is 48 kHz with 24-bit sample size.
- Messages and tones are stored as high definition uncompressed wav-files.

**Supervision**

- Supervision of stored messages and tones.
- Supervision of data integrity of site specific data.
- Internal watchdog timers to detect and recover from processing errors.
- Faults or problems of all system devices are collected, reported and logged.

**Fault tolerance**

- Eight system controllers can be configured as redundant pairs.
- Five OMNEO network connection ports, supporting RSTP.
- Dual DC-inputs with polarity reversal protection.

**Variants of the PRAESENSA system controller**

Variant	PRA-SCL	PRA-SCS
Dynamic OMNEO audio channels (secure)	1000	1000
Dynamic OMNEO tone/message playback channels (secure)	8	8
Static Dante or AES67 audio channels (secure, input and/or output)	Pool of 8	Pool of 8
Static Dante or AES67 audio channels (open, input)	112	—
Maximum number of networked devices	250	250
Number of amplifiers in the system	System setup dependent	6

**Connection and functional diagram**

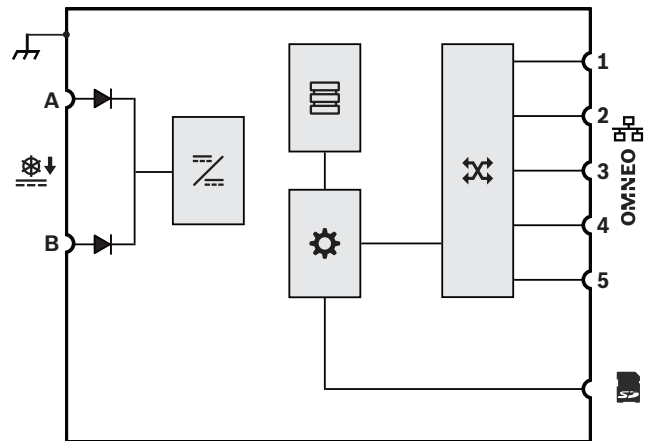

	Diode		DC to DC converter
	Message and tone storage		Controller
	OMNEO network switch		

**Front view**



**Front panel indicators**

	Device fault present	Yellow
	Network link present Network link lost Standby for redundancy	Green Yellow Blue
	Power on	Green

**Rear view**









**Rear panel indicators**

	100 Mbps network 1 Gbps network	Yellow Green
	Power on Device in identification mode	Green Green blinking
	Device fault present	Yellow
	SD card busy; do not remove	Green

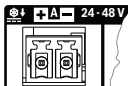
**Rear panel controls**

	Device reset (to factory default)	Button
--	-----------------------------------	--------

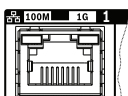
**Rear panel connections**

	24 to 48 VDC input A-B	
	Memory card	
	Network port 1-5	
	Chassis ground	

**Architects' and engineers' specifications**

The IP-networked system controller shall be designed exclusively for use with Bosch PRAESENSA systems. The system controller shall dynamically assign network audio channels for audio routing between system devices across multiple subnets. It shall support >100 simultaneous high-resolution audio channels (24-bit, 48 kHz) for music routing and making calls, with encryption and authentication to protect against eavesdropping and hacking. It shall be capable of receiving Dante and AES67 audio streams. A SIP/VoIP telephone interface shall be available. The system controller shall provide an interface for control data and multi-channel digital audio over OMNEO using an integrated 5-port Ethernet switch for redundant network connections, supporting RSTP and loop-through cabling. The system controller shall have dual power supply inputs and power supplies. The system controller shall manage all devices in the system to provide the configured system functions. It shall incorporate a supervised storage for message and tone files with networked playback of up to eight streams simultaneously. It shall keep an internal log of fault events and call events. The system controller shall provide a secure TCP/IP open interface for remote control and diagnostics. The system controller shall provide front-panel LED indications for the status of power supplies and the presence of faults in the system and provide additional software monitoring and fault reporting features. The system controller shall be rack mountable (1U). It shall be possible to connect a backup system controller for dual redundancy with automatic fail-over. The system controller shall be certified for EN 54-16 / ISO 7240-16, marked for CE and be compliant with the RoHS directive. Warranty shall be three years minimum. If the system size permits, the system controller shall be a Bosch PRA-SCS, otherwise a Bosch PRA-SCL.

**Regulatory information**

**Emergency standard certifications**

Europe	EN 54-16 (0560-CPR-182190000)
International	ISO 7240-16

**Emergency standard compliance**

Europe	EN 50849
UK	BS 5839-8

**Regulatory areas**

Safety	EN/IEC/CSA/UL 62368-1
Immunity	EN 55035 EN 50130-4
Emissions	EN 55032 EN 61000-6-3 ICES-003 FCC-47 part 15B class A EN 62479
Environment	EN/IEC 63000
Railway applications	EN 50121-4

**Installation/configuration notes**

This is a professional product that should be installed, used and maintained by trained professionals only.

**Parts included**

Quantity	Component
1	System controller
1	Set of 19"-rack mounting brackets (pre-mounted)
1	Set of screw connectors and cables
1	Quick Installation Guide
1	Safety and security information

**Technical specifications**

**Electrical**

**System**

Routing (audio, dynamic): OMNEO channels	Unlimited
Tone/Message playback (dynamic): OMNEO channels	8

Number of inputs (audio, static): Dante or AES67 channels	8
Number of outputs (audio, static): Dante channels	8
Number of events: Logging (internal storage)	6,000
Call events	2,000
Fault events	2,000
General events	2,000
Real time clock synchronization	NTP
Accuracy with NTP	< 1 s/yr off
Accuracy without NTP	< 11 min/yr off
Daylight saving time correction	Automatic
Backup battery type	Lithium
Battery size	CR2032
Tone/Message storage (min) (mono, uncompressed, 48 kHz, 16 bit)	90 min
SD Memory card capacity (GB)	32 GB
<b>System size</b>	
Networked devices (single subnet)	250
Networked amplifiers	6
Number of output zones (with PRA-AD608 amplifiers)	48
Configuration	Web server/browser

**Power transfer**

Operating voltage (VDC) range	24 VDC – 48 VDC
Operating voltage (VDC) tolerance	20 VDC – 60 VDC
Power consumption (W) duty mode	3.90 W
Power consumption (W) per active port	0.4 W

**Supervision**

Run fault (watchdog reset)	All processors
Fault report time (s)	< 100 s

Site specific data integrity fault report time (h)	< 1 h
Protection	Watchdog; RSTP

**Network interface**

Protocols / standards	TCP/IP; OMNEO; Dante; AES70; AES67
Ethernet type	100BASE-TX; 1000BASE-T
Latency (ms)	10 ms
Encryption	TLS
Audio encryption	AES 128
Number of Ethernet ports	5

**Reliability**

Mean time between failures (MTBF) (h) (extrapolated from calculated MTBF of PRA-AD608 )	1,000,000 h
---	-------------

**Environmental**

Operating temperature (°C)	-5 °C – 50 °C
Operating temperature (°F)	23 °F – 122 °F
Storage temperature (°C)	-30 °C – 70 °C
Storage temperature (°F)	-22 °F – 158 °F
Operating relative humidity, non-condensing (%)	5% – 95%
Air pressure (hPa)	560 hPa – 1,070 hPa
Installation altitude (m)	-500 m – 5,000 m
Installation altitude (ft)	-1,640 ft – 16,404 ft

**Operating vibration**

Amplitude (mm)	< 0.70 mm
Acceleration (G)	< 2 G
Bump (transport) (G)	< 10 G (IEC 60068-2-27)

**Mechanical**

Dimensions (H x W x D) (mm)	44 mm x 483 mm x 400 mm
Dimensions (H x W x D) (in)	1.75 in x 19 in x 15.7 in
Rack unit (U)	1 U, 19 in

IP rating	IP30
Material	Steel; Zamac
Color (RAL)	RAL 9017 Traffic black
Weight (kg)	5.80 kg
Weight (lb)	12.80 lb

### Ordering information

#### **PRA-SCS System controller, small**

Network-connected, DC-powered, system controller and message manager for Public Address and Voice Alarm applications.

Order number **PRA-SCS | F.01U.325.040**

### Software Options

#### **PRA-LSPRA License for subsystem PRAESENSA**

This software license enables the creation of subsystems connected to a master system controller within the PRAESENSA system.

Order number **PRA-LSPRA | F.01U.402.624**

#### **PRA-LSCRF License call recording and forwarding**

The PRA-LSCRF software license enables the stacking and time-shifting of calls within the PRAESENSA system. It can be installed in the PRA-SCL or the PRA-SCS.

Order number **PRA-LSCRF | F.01U.425.784**

### Services

#### **EWE-PRASCS-IW 12 mths wrty ext Praes Syst Contr Sml**

12 months warranty extension

Order number **EWE-PRASCS-IW | F.01U.387.313**



<https://www.boschsecurity.com>