

1 |

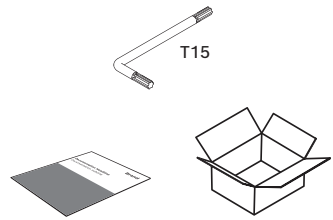

2 |

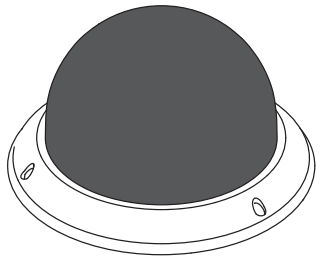
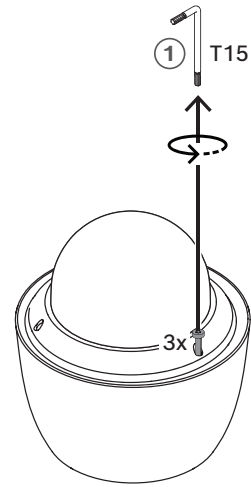

3 |

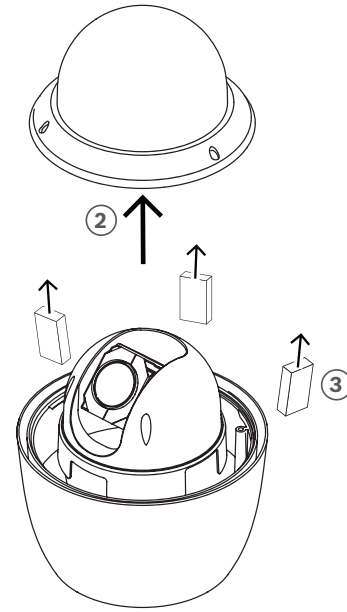

4 |

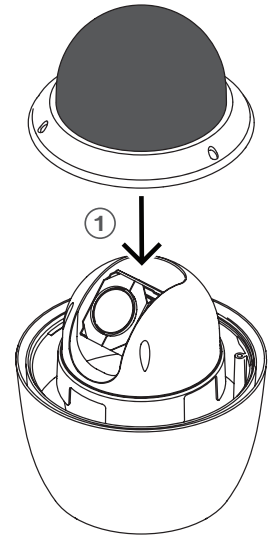

5 |

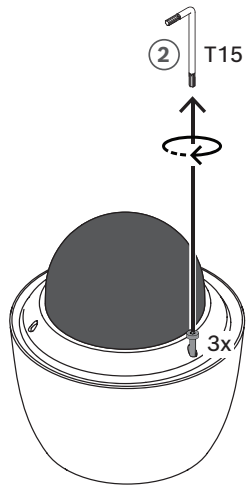

Tinted bubble for PTZ dome

NDA-5020-PTBL

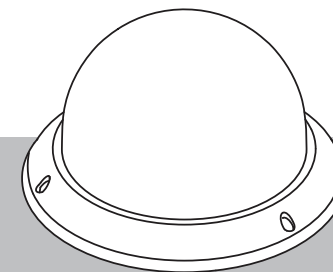

en Quick installation guide

Bosch Security Systems B.V.

Torenallee 49
5617 BA Eindhoven
Netherlands

www.boschsecurity.com

© Bosch Security Systems B.V., 2022