

Reference Guide for the DS7400Xi (Version 3+) Control/Communicator

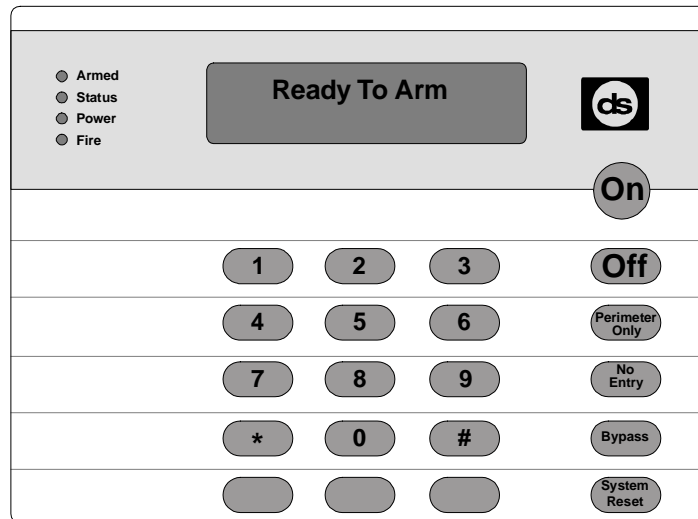

Keypad Quick Reference Guide

Turning On (arming) your System using the DS7445/DS7445i or DS7447/DS7447E Keypad

Normal Arming	[PIN] + [On]
Perimeter Arming, no entry delay	[PIN] + [No Entry] [Perimeter Only]
Perimeter Arming, with entry delay	[PIN] + [Perimeter Only]
Maximum Security Arming	[PIN] + [No Entry] + [On]
Custom Arming	[PIN] + [#] [4]
Set Delayed Arming	[PIN] + [#] [9] [9] and enter number of hours from current time to the desired arming time.
Extend Automatic Arming during pre-arm time	[PIN] + [OFF]
Force Arming	Enter an arming command followed by [Bypass]
Zone Bypass	[PIN] + [Bypass] followed by the Zone number. [PIN] + [Bypass] [*] to clear ALL Bypasses.

Turning Off (disarming) your System

Enter your [PIN] followed by [Off]

Commands for other System Features

Chime Mode	[PIN] + [#] [7]
System Walk Test	[PIN] + [#] [8] [1]
Event History Readback	[PIN] + [#] [8] [9]
Battery Test	[PIN] + [System Reset]
Communicator Test	[PIN] + [#] [8] [2]
Fire Reset	[PIN] + [System Reset]
Remote Program Dial-out	[PIN] + [#] [8] [3]
Remote Program Answer	[PIN] + [#] [8] [6]
Battery/Sounder Test	[PIN] + [#] [8] [5]
Error Display	[PIN] + [#] [8] [7]
Clear Error Display	[PIN] + [System Reset]
Fire Walk Test	[PIN] + [#] [9] [1]
To Silence a Fire Trouble/Alarm	[PIN] + [Off]
To Clear a Fire Trouble Display	[PIN] + [System Reset]

Access Control

Enter your [Access Control PIN] followed by [Off]



detection systems

A member of the
Bosch Group

Table of Contents

Keypad Quick Reference Guide	1	7.4	Changing the Temporary PIN Expiration Date ...	23
1.0 Specifications	4	7.5	Changing the Time	24
1.1 Enclosure Housing	4	7.6	Delayed Arming	24
1.2 Temperature	4	7.7	Automatic Arming	25
1.3 Power	4	7.8	Turning OFF the System under Duress	26
1.4 Outputs	4	7.9	Automatic Disarming	26
1.5 Zones	4	7.10	Emergency Procedures	26
1.6 Keypads	4	7.10.1	Identifying Alarm Sounds	26
1.7 Communicator	4	7.10.2	Silencing Alarms	26
1.8 Partitions	4	7.10.3	A Cautionary Note	26
1.9 Users	4	7.10.4	Use Common Sense	26
1.10 Lightning Protection	4	7.10.5	Caution When Entering A Building	26
1.11 Burglar/Fire Zone Inputs	4	7.10.6	Fire Alarms	26
1.12 Fire Signal Initiating Circuit (2-wire mode)	4	7.11	Fire Reset/Fire Trouble	27
1.13 Multiplex Bus Wiring Requirements	4	7.11.1	Fire Reset	27
1.13.1 Multiplex Zone Loop Wiring	4	7.11.2	Fire Trouble	27
1.14 Option Bus Wiring Requirements	4	7.12	Emergency Keypad Alarms	27
1.15 Max. Load Currents	5	7.13	Fire Safety	27
1.16 Backup Battery Calculation	5	7.13.1	If Installed in Family Residences	27
1.17 Standby Current Load	5	7.11.3	Dirty Smoke	27
1.18 Options	6	7.14	Testing	28
2.0 Enclosure Installation	8	7.14.1	System Walk Test	28
2.1 Install the Enclosure	8	7.13.2	Having and Practicing an Escape Plan	28
2.2 Install the Control/Communicator	8	7.13.3	Installation Considerations	28
3.0 Control Terminal Wiring	9	7.14.2	Fire Walk Test	29
4.0 Hardware Layout Example	10	7.14.3	Battery/Sounder Test	29
5.0 System Worksheet	11	7.14.4	Communicator Test	30
6.0 Glossary	15	7.14.5	Event History Readback	30
6.1 General Control Programming	15	7.14.6	Remote Program Dial-out and Answer	30
6.2 Zone Function Programming	15	7.14.7	Error Displays/Warnings	31
6.3 Zone Programming	16	8.0 Keypads	32	
6.4 Output Programming	17	8.1	The Master Keypad	32
6.5 Partition Control Programming	17	8.2	Master Keypad Displays	32
6.6 Keypad Assignment Programming	18	8.3	Arming from the Master Keypad	32
6.7 Emergency Key Programming	18	8.4	Disarming from the Master Keypad	33
6.8 Custom Arming Programming	18	8.5	Single Partition Mode	33
6.9 Force Arming	18	8.6	Volume and Backlight Controls	33
6.10 Ground Fault Detect Programming	18	9.0 How to Program the Control Panel	34	
6.11 Commercial Fire Mode Programming	18	9.1	Entering the Programmer's Mode	34
6.12 Open/Close Report Control Programming	19	9.2	Reading back a Program Address	34
6.13 Report Programming	19	9.3	Entering a value in a Program Address	34
6.14 Phone Number General Control Programming ...	20	9.4	HEX values	34
6.15 Phone Answering Programming	20	9.5	Defaults	34
6.16 FCC Compliance Notice	20	9.6	Setting the Control to the Factory Default	34
6.17 FCC Phone Connection Notice To Users	20	9.7	Exiting the Programmer's Mode	35
6.18 Canadian Dept. of Communications	21	10.0 Understanding the Programming Charts	35	
6.19 For Installations in New Zealand	21	11.0 Programming	36	
7.0 Operating Guide	22	11.1	General Control Programming: Program Address (0000)	36
7.1 Personal Identification Numbers	22	11.2	Zone Function Programming: Program Addresses (0001-0015)	37
7.1.1 General Information	22	11.3	Zone Programming: Program Addresses (0018-0145)	38
7.1.2 Removing a PIN	22	11.4	Zone Partition Assignment: Program Addresses (1248-1311)	39
7.1.3 Authority Levels	22	11.5	Zone Bypass Programming: Program Addresses (0016-0017)	40
7.2 Arming/Disarming Commands	23	11.6	Output Programming: Program Addresses (0146-0148)	41
7.3 Changing the Date	23			

11.7	Output Partition Assignment: Program Addresses (0149-0150)	42	Programming: Program Address (1520)	61	
11.8	Partition Control Programming: Program Address (0165)	42	11.35	Call-Out Timer Programming: Program Addresses (1521-1524)	62
11.9	Quick Arm Control Programming: Program Address (0169)	43	11.36	Test Report and Remote Programmer Call-Out Programming: Program Address (1525)	62
11.10	Keypad Assignment Programming: Program Addresses (0173-0180)	44	11.37	Alpha Description Programming: Program Addresses (1526-3701)	63
11.11	Keypad Partition Assignment: Program Addresses (0208-0215)	44	11.38	Phone Number Programming: Program Addresses (4028, 4038, 4048)	68
11.12	Emergency Key Programming: Program Addresses (0181-0182)	45	11.39	Pager Delay Time: Program Address (3914)	68
11.13	Custom Arming Programming: Program Addresses (0183-0184)	45	12.0	Installation Guide for U.L. Listed Systems	69
11.14	Force Arming and Ground Fault Detect Programming: Program Address (0185)	46	12.1	DS7400Xi U. L. Listings:	69
11.15	Commercial Fire Mode Programming: Program Address (0186)	47	12.1.1	U.L. System Configurations	69
11.16	Open/Close Report Control Programming: Program Address (0187)	48	12.2	Installation Considerations	69
11.17	Open/Close & Zone Report Control Programming: Program Address (0189)	48	12.3	Programming the DS7400Xi	70
11.18	Report Control Programming: Program Address (0190)	48	12.3.1	Household Fire Alarm using Digital Alarm Communicator Transmitter with local bell .	70
11.19	Timer Programming: Program Addresses (0191-0193, 0195-0196)	49	12.3.2	Grade A Household Burglary Alarm using Digital Alarm Communicator Transmitter with local bell	70
11.20	AC Fail Report Delay Programming: Program Address (0197)	49	12.4	General System Requirements	70
11.21	General Code "Arm Only" Programming: Program Address (0198-0201)	50	12.4.1	Local Burglary Alarm	71
11.22	Arming Warning Programming: Program Addresses (0202-0205)	50	12.4.2	Police Station Connection	71
11.23	DS7412 RS232 Interface Control Programming: Program Address (0206)	51	12.4.3	Central Station Burglary Alarm and Proprietary	71
11.24	DS7412 RS232 Interface Configuration Programming: Program Address (0207)	51	12.5	Commercial Fire Alarm	71
11.25	Report Programming: Program Addresses (0256-0304 and 0320-0340)	52	12.6	Wiring and Programming Information for Installations Using the Ademco AB-12 Bell/Housing	72
11.26	Phone/ARDIS Routing Control: Program Addresses (0494-0495)	54	13.0	Report Programming	73
11.27	Account Code Programming: Program Addresses (0496-0526)	55	13.1	4/2 Format	73
11.28	Phone Number General Control Programming: Program Address (0528)	56	13.2	BFSK Format	74
11.29	Phone Number Format Programming: Program Addresses (0529-0530)	56	13.3	Personal Dialing and Pager Format	75
11.29.1	Compatible Receivers	57	13.4	Pager Format	75
11.30	Phone Answering Programming: Program Address (0531)	57	14.0	Report Programming - Values Sent	77
11.31	Programmer's and Master Code Programming: Programming Addresses (0532-0534)	58	14.1	SIA Formats	77
11.32	Octal Relay Module Output Programming: Program Addresses (1456-1471)	58	14.2	CID Formats	79
11.32.1	Octal Relay Module Output Partition Assignment: Program Addresses (3725-3732) ...	59	15.0	Multiplex Zone Addressing Guide	80
11.33	Output Function Programming: Program Addresses (1472-1516)	60	16.0	Troubleshooting Guide	81
11.33.1	Output Function Partition Assignment: Program Addresses (3733-3740)	61	16.1	Keypad Problems	81
11.34	Dual Phone Line/Bell Supervision Module Output		16.2	Reporting Problems	82
			16.3	Zone Problems	82
			16.4	General System Problems	83
			17.0	Program Addresses	87
			Index	90	

1.0 Specifications

1.1 Enclosure Housing

The standard enclosure is manufactured from 20 Ga., cold-rolled steel, and measures 12.5" Wide, by 14.5" High, by 3" Deep (31.8 cm x 36.8 cm x 7.6 cm). A keyed lock is included, and this enclosure has provision for an optional tamper switch (required for commercial burglary applications) for monitoring the door.

1.2 Temperature

- Storage and Operating Temperature: +32° to +120°F (0° to +49°C)

1.3 Power

NOTE The total current output capacity for all auxiliary devices, including keypads and smoke detectors = 1.5 A standby, 2.5 A alarm. The following ratings are maximum values. The total combined output cannot exceed the max. load current.

- Input power: 18 VAC, 50 VA, 50 Hz./60 Hz.
- Auxiliary regulated power: 12 VDC, 1.0 A max.
- U. L. Listed Auxiliary power: 12 VDC, 1.0 A max.
- U. L. Listed Alarm Power Output: 12 VDC, 1.75 A max.
- Auxiliary power voltage range: 12 V special application
- Optional Standby battery (P334): 12 V, 7.0 AH - 35 AH max.
- Control panel current draw: 175 mA, Standby
250 mA, Alarm

1.4 Outputs

- Alarm Output: 12 VDC, 1.75 A output. Can be programmed for steady or pulsed output.
- Programmable Output 1* Solid state current sink (1.0 A max.). Shorts to Aux. negative when activated. Connect device to Aux. power positive. Can be used for alarm, arming state, or access control.** This output is generally programmable.
- Programmable Output 2* Solid state voltage source (500 mA max.). Can be used for alarm, arming state, or access control.** This output is generally programmable. For use with such compatible devices as the Listed DS250 with a 4-wire base.

* = Current draw should be subtracted from either maximum auxiliary or maximum alarm current draw.

** = Not investigated to the requirements of UL294.

1.5 Zones

- 8 on-board zones. Up to 128 total zones with expansion modules.
- Zone Response Time: 300 ms.

1.6 Keypads

- Maximum # of keypads: 15 Keypads
- Maximum wire length each: 1000 feet (305 m)
- Maximum wire length total: 6000 feet (1830 m) in system
- Wire type: 4 conductor, unshielded, #22 AWG (0.8 mm) "Telephone quad" or #18 AWG (1.0 mm) quad wiring can be home-run or daisy- chained.

NOTE No more than 2 keypads (#22 AWG) or 3 keypads (#18

AWG) are recommended on any 1000 foot (305 m) run. Shared cable is not recommended for keypad, multiplex, options bus, telephone, or siren wiring.

NOTE

1.7 Communicator

Will report to two phone numbers with full single, double and back-up reporting. Communicates in SIA (110 or 300 baud), 3/1, 3/1 Ext., 3/1 with Parity, 3/1 Ext. with Parity, 4/1, 4/2, BFSK, Contact ID, Personal Dialing and Pager formats.

FCC Registration Number is ESVUSA-75333-AL-E

The ringer equivalence is 0.1B

Commercial Fire CSFM Listing Number is 7165-1062:111

Residential Fire CSFM Listing Number is 7167-1062:111

1.8 Partitions

The system has the capacity for 8 independent partitions. One partition may be a common area.

1.9 Users

The DS7400Xi system allows up to 90 individual users. Each user will have his own PIN number (the 4 digit code entered at the keypads) and his own authority level (to determine which functions he may perform).

1.10 Lightning Protection

MOVs and spark gaps provide protection from lightning surges and static discharges.

1.11 Burglar/Fire Zone Inputs

- Number of circuits: 8 Circuits on-board
- End-of-line resistor: 2.2 K Ω (P/N 25944, provided)
- Loop resistance tolerance: 60 ohms

1.12 Fire Signal Initiating Circuit (2-wire mode)

Fire circuit will work with 2- or 4-wire detectors and has optional alarm verification.

- Number of circuits: 8 Circuits on-board
- Type of circuit: Class B, latching
- End-of-line resistor: 2.2 K Ω (P/N 25944, provided)
- Supervisory current: 5.5 mA
- Maximum short circuit current: 22 mA
- Maximum line resistance: 60 ohms
- Circuit voltage range: 8.5 to 14.1 VDC
- Total detector standby current: 2.5 mA

1.13 Multiplex Bus Wiring Requirements

- #22 AWG (0.8 mm). Up to 2000 feet (610 m) per system.
- #18 AWG (1.0 mm). Up to 5000 feet (1525 m) per system.



IMPORTANT

Do **not** use twisted pair or shielded cable for multiplex bus wiring.

1.13.1 Multiplex Zone Loop Wiring

- Maximum wire length not to exceed 500 feet (150m) regardless of the wire gauge.

1.14 Option Bus Wiring Requirements

- Maximum wire length 1000 feet (305 m) per home-run.

1.15 Max. Load Currents

Max. Load Currents	Standby	Alarm
U. L. Installations	1.5 A	2.5 A
Non-U. L. Applications	2.0 A	2.5 A
Max. Current By Output: Not to exceed the max. load currents listed above per column.		
Aux. Power & Keypad (Combined)	1.0 A	1.0 A
Option Power	1.0 A	1.0 A
Bell Output	X	1.75 A
Programmable Output 2	500 mA	500 mA
Loop Power +	500 mA	500 mA

1.16 Backup Battery Calculation

- The following table is used to calculate the standby battery capacity required by NFPA when using the DS7400Xi:

Device	Quantity	Standby Current Per Device	Total Standby Current (Quantity x Standby Current Per Device)	Alarm Current Per Device	Total Alarm Current (Quantity x Alarm Current Per Device)
Control Panel	1	175 mA	175 mA	250 mA	250 mA
ARDIS Communications Module		127 mA		127 mA	
DS7420i - Dual Line/Bell Supervision		20 mA		140mA	
DS7430 - Multiplex Expansion		65 mA		65 mA	
DS7432 - 8 Input Remote		10 mA		10 mA	
DS7433 - 8 Input Direct		65 mA		80 mA*	
DS7445/DS7445i Keypad		75 mA		75 mA	
DS7447/DS7447E Keypad		100 mA		100 mA	
DS7450 & DS7452 - Contact Points		350 µA		350 µA	
DS7457 - Single Zone Multiplex Input		350 µA		350 µA	
DS7460 - Dual Zone		1 mA		1 mA	
DS7465 - Input/Output		1 mA		1 mA	
DS7480 - Bell Supervision		7 mA		50 mA	
DS7481 - Single Line Monitor		20 mA		20 mA	
DS7488 - Octal Relay*		10 mA + 40 mA**		10 mA + 40 mA**	
DS7489 - Solid State Output Module		10 mA		750 mA max***	
MX280 Series Multiplex Smoke Detectors		500 µA		560 µA	
MX540 (DS7473) PIR Detector		800 µA		800 µA	
MX835 TriTech Microwave/PIR Detector		6 mA		35 mA	
MX775 (DS7470)PIR Detector		200 µA		200 µA	
MX794 (DS7474) PIR Detector		800 µA		800 µA	
MX934 (DS7471) PIR Detector		200 µA		200 µA	
MX938 (DS7472) Ceiling Mount PIR		200 µA		200 µA	
MX950 (DS7476)TriTech Microwave/PIR		6 mA		35 mA	
2-Wire Smoke Detectors					
4-Wire Smoke Detectors					
Bells, Horns, etc.					
Other sensors					
Other					
		Grand Total		Grand Total	

* = Add 15 mA for each additional zone in alarm.

** = When calculating Standby and Alarm Current for the Octal-Relay Module, use 10 mA plus 40 mA for each activated relay.

*** = Maximum current draw if using DS7400Xi panel power supply. Total of all outputs cannot exceed 750 mA.

1.17 Standby Current Load

- Battery AH - (20% Storage + 0.375 AH's Alarm)
- The following table is the derated battery divided by hours minus the control standby (175 mA):

Rechargeable Battery Size	Max. Standby for 4 hours	Max. Standby for 8 hours	Max. Standby for 24 hours	Max. Standby for 48 hours	Max. Standby for 60 hours	Max. Standby for 72 hours	Max. Standby for 80 hours
7 AH	1.0 A	470 mA	X	X	X	X	X
8 AH	1.2 A	580 mA	X	X	X	X	X
14 AH	1.5 A	1.1 A	270 mA	X	X	X	X
15 AH	1.5 A	1.2 A	300 mA	X	X	X	X
17.2 AH	1.5 A	1.5 A	380 mA	100 mA	X	X	X
21 AH	1.5 A	1.5 A	500 mA	160 mA	100 mA	X	X
28 AH	1.5 A	1.5 A	740 mA	280 mA	190 mA	130 mA	100 mA
30 AH	1.5 A	1.5 A	800 mA	310 mA	210 mA	150 mA	120 mA
35 AH	1.5 A	1.5 A	970 mA	400 mA	280 mA	200 mA	170 mA

1.18 Options

- **DS7412:** RS232 Serial Interface module. The DS7412 module allows the panel to send event information, in an ASCII format, directly to a serial printer or computer. In addition, the interface allows the direct connection of a computer to the panel for programming via the WDSRP programming software.
 - Current Draw= 25 mA, 35 mA with LEDs on.
- **DS7420i:** Dual Phone Line/Bell Supervision Module (1 per system).

The DS7420i allows the control to be used in NFPA 72 installations. It provides two supervised 12.0 VDC signaling outputs, one Class A (Style D) input zone, and dual phone line transmission and supervision.

 - Current Draw = 20 mA, Standby. 140 mA, Alarm.
- **DS7430:** Multiplex Expansion Module (1 per system).

The DS7430 provides a two-wire multiplex bus for the connection of additional remote zones. It also supplies up to 200 mA for 4-wire multiplex devices such as the DS7432.

 - Current Draw = 65 mA, Standby. 65 mA, Alarm.
- **DS7432:** 8 Input Remote Module (up to 15 per system. Requires a DS7430 Multiplex Expansion Module). The DS7432 provides a means of monitoring conventional Normally Open or Normally Closed contacts. It reports their status to the control panel as multiplex addresses. It occupies eight multiplex zones on the system and can monitor up to eight separate loops. It will support 4-wire smoke detectors.
 - Current Draw = 10 mA, Standby. 10 mA, Alarm.
- **DS7433:** 8 Input Direct Module (1 per system. Can not be used with the DS7430 or DS7436 Multiplex Expansion Modules).

The DS7433 provides a means of expanding the system to include eight additional hard-wired zones. Each zone can support up to twenty 2-wire smoke detectors (can also support 4-wire smoke detectors).

 - Current Draw = 65 mA, Standby. 80 mA, Alarm. Add 15 mA for each additional zone in alarm.
- **DS7436:** Multiplex Expansion Module (1 per system).

The DS7436 provides two two-wire multiplex buses for the connection of up to 120 remote points. It also supplies 200mA per bus.

 - Current Draw = 130mA, Standby or Alarm
- **DS7445/DS7445i:** Control Station.

The DS7445/DS7445i is an LED keypad which has LEDs representing the first 8 zones of the system. It displays information on various control panel functions. A built in sounder is used as an interior warning device and to annunciate keystroke entries.

 - Current Draw = 75 mA, Standby. 75 mA, Alarm.
- **DS7447/DS7447E:** Control Station.

The DS7447/DS7447E is an Alpha-Numeric LCD keypad. It displays information on various control panel functions. A built-in sounder is used as an interior warning device and to annunciate keystroke entries.

 - Current Draw = 100 mA, Standby. 100 mA, Alarm.
 - Keypad Access Output: The DS7447/DS7447E Alpha Keypad will provide a ten (10) second access relay output if equipped with the optional K800 Relay. The relay will energize at the keypad if the user has a master, unlimited, general, or access PIN. The output will change only if the user has access to the partition assigned to the keypad. See the DS7447/DS7447E Keypad Installation Instructions (P/N 22235) for wiring information.
- **DS7450:** Flush Mount Single Multiplex Contact Point (requires a DS7430 Multiplex Expansion Module).

The DS7450 is intended as a replacement for conventional dry contacts, and to report an actual multiplex address to the control panel. Occupies 1 zone.

 - Current Draw = 350 μ A, Standby. 350 μ A, Alarm.
- **DS7452:** Surface Mount Single Multiplex Contact Point (requires a DS7430 Multiplex Expansion Module).

The DS7452 is intended as a replacement for conventional dry contacts, and to report an actual multiplex address to the control panel. Occupies 1 zone.

 - Current Draw = 350 μ A, Standby. 350 μ A, Alarm.
- **DS7455:** Surface Mount Single Multiplex Contact Point (requires a DS7430 Multiplex Expansion Module).

The DS7455 is intended as a replacement for conventional dry contacts, and to report an actual multiplex address to the control panel. Occupies 1 zone.

 - Current Draw = 350 μ A, Standby. 350 μ A, Alarm.
- **DS7457:** Single Zone Multiplex Input Module (requires a DS7430 Multiplex Expansion Module).

The DS7457 provides a means of monitoring conventionally Normally Open or Normally Closed contacts. It reports their status to the control panel as multiplex addresses. It occupies one multiplex zone on the system and can monitor one loop. It also includes a tamper loop.

 - Current Draw = 350 μ A, Standby. 350 μ A, Alarm.
- **DS7460:** Dual Zone Module (up to 60 per system. Requires a DS7430 Multiplex Expansion Module).

The DS7460 provides a means of monitoring conventional Normally Open or Normally Closed contacts. It reports their status to the control panel as multiplex addresses. It occupies two multiplex zones on the system and can monitor up to two separate loops.

 - Current Draw = 1 mA, Standby. 1 mA, Alarm.
- **DS7465:** Input/Output Module (up to 20 per system. Requires a DS7430 Multiplex Expansion Module).

The DS7465 provides a Form "C" relay that may be programmed to activate on system events, and an input loop to monitor conventional Normally Open or Normally Closed contacts. It reports their status to the control panel as multiplex addresses.

 - Current Draw = 1 mA, Standby. 1 mA, with relay energized.
 - Occupies 2 zones.
- **DS7480:** Bell Supervision Module (1 per system).

The DS7480 provides a means of monitoring bells. It provides a supervised (polarity reversing) output relay

to activate the bell. It also provides a Form "C" Bell Fault Output to be connected to the control panel.

- Current Draw = 7 mA @ 12 VDC, Standby. 50 mA @ 12 VDC, Alarm.

- **DS7481:** Single Phone Line Monitor (1 per system). The DS7481 provides a means of monitoring a single phone line for fault conditions. When a fault is detected, the DS7481 automatically closes its Normally Open relay contacts to provide a means of signaling the fault.
 - Current Draw = 20 mA, Standby. 20 mA, Alarm.
- **DS7488:** Octal Relay Module (2 per system). The DS7488 provides 8 Form "C" relay outputs for addition to the system. The outputs are fully programmable and can be activated by system events. Each output operates individually of the other 7 outputs for complete flexibility.
 - Current Draw = 10 mA + 40 mA for each relay when energized.
- **DS7489:** Solid State Output Module (2 per system). The DS7489 is a Solid State Octal Driver Module that provides 8 open collector transistor outputs. The outputs are fully programmable and can be activated by system events. Each output operates individually of the other 7 outputs for complete flexibility. The DS7489 Module has not been investigated by Underwriters Laboratories, Inc.
 - Current Draw: 10mA.
 - Outputs: Provides a current sink (the output shorts to common (-) when activated). The maximum current draw for all 8 outputs combined cannot exceed 750 mA.
- **MX280:** Multiplexed Photoelectric Smoke Detector (up to 120 detectors may be used per system. Requires a DS7430 and occupies one multiplex zone). Detects smoke and automatically determines the detector's sensitivity using the Detection Systems "Chamber Check" feature. The MX280 Detector has not been investigated by Underwriters Laboratories, Inc.
 - Current Draw: 500 μ A Standby, 560 μ A Alarm.
- **MX280TH:** Multiplexed Photoelectric Smoke Detector with a 135°F (57° C) heat sensor (up to 120 detectors may be used per system. Requires a DS7430 and occupies one multiplex zone). Detects smoke and is equipped with a 135°F (57° C) heat sensor for high temperature alarms. The Detection Systems "Chamber Check" feature automatically determines the detector's sensitivity. The MX280TH Detector has not been investigated by Underwriters Laboratories, Inc.
 - Current Draw: 500 μ A Standby, 560 μ A Alarm.
- **MX280THL:** Multiplexed Photoelectric Smoke Detector with a 135°F (57° C) heat sensor and a 45°F (7° C) freeze alarm (up to 60 detectors may be used per system. Requires a DS7430 and occupies two multiplex zones). Detects smoke and is equipped with a 135°F (57° C) heat sensor for high temperature alarms and a 45°F (7° C) sensor for freeze alarms. Freeze alarms are reported separately from smoke and high temperature alarms. The Detection Systems "Chamber Check" feature automatically determines the detector's sensitivity. The MX280THL Detector has not been investigated by Underwriters Laboratories, Inc.
 - Current Draw: 500 μ A Standby, 560 μ A Alarm.

- **MX540:** Multiplexed Passive Infrared (PIR) Intrusion Detector with a standard range of 40 by 50 feet (12 by 15 meters). Requires a DS7430 and occupies one multiplex zone.
 - Current Draw = 800 μ A Standby and Alarm.
- **MX835:** TriTech Microwave/PIR Intrusion Detector with "Pet Avoidance" technology and a standard range of 35 by 35 feet (10.7 by 10.7 m). Requires a DS7430 and occupies one multiplex zone.
 - Current Draw= 6 mA standby, 35 mA in "Trouble" and walk test mode.
- **MX775:** Multiplex Passive Infrared (PIR) Intrusion Detector with a standard range of 50 by 50 feet (15m by 15m). Requires a DS7430 and occupies one multiplex zone.
 - Current Draw= 200 μ A standby, 2 μ A in walk test mode.
- **MX794:** The MX794 is a Long Range Multiplex PIR Intrusion Detector with Self-test. The standard ranges are 80 ft. by 50 ft. (24.0m by 15.0m) and 200 ft. by 10 ft. (61.0 m by 3.1 m). Requires a DS7430 and occupies one multiplex zone.
 - Current Draw = 800 μ A Standby and Alarm.
- **MX934:** Multiplex Passive Infrared (PIR) intrusion detector with a standard range of 35 by 35 feet (10.7m by 10.7m). Requires a DS7430 and occupies one multiplex zone.
 - Current Draw= 200 μ A standby, 2 μ A in walk test mode.
- **MX938:** 360° Ceiling Mount Multiplex PIR Intrusion Detector with a 60 foot (18.3m) diameter range. Requires a DS7430 and occupies one multiplex zone.
 - Current Draw= 200 μ A standby, 2.5 μ A in walk test mode.
- **MX950:** Multiplex TriTech Microwave/PIR Intrusion Detector with motion monitor and anti-mask features and with a standard range of 50 by 50 feet (15m by 15m). Requires a DS7430 and occupies one multiplex zone.
 - Current Draw= 6 mA standby, 35 mA in "Trouble" and walk test mode.
- **ARDISSM Communications Module.** Various model numbers. The Communications Module provides a means of communicating alarm and supervision signals using the ARDIS radio network. This can be a replacement for, or a compliment to, the standard digital communicator.
 - Current draw: 127 mA Standby and Alarm.

The control/communicator is also available in three package formats. The packages include the following:

- **DS7400XiF:** DS7400Xi in large red enclosure (manufactured from 18 Ga., cold-rolled steel, and measures 15.0" Wide, by 20.75" High, by 4.25" Deep (38.1 cm W, by 52.7 cm H, by 10.8 cm D)).
- **DS7400XiFCP:** DS7400XiF package with: DS7420i, DS7447/DS7447E and a AE-TR16
- **DS7400XiCC:** DS7400Xi in an Attack Enclosure.

When installing a U. L. Listed system, refer to the Installation Guide for U. L. Listed Systems.

See Section 12.0.

2.0 Enclosure Installation

The DS7400Xi control/communicator and the enclosure are shipped together. The control, however, still needs to be installed into the enclosure. Hardware for mounting the enclosure to a wall, and the control to the enclosure is located in its own hardware pack.

2.1 Install the Enclosure

- Use the enclosure as a template and mark the top mounting holes on the mounting surface.
- Pre-start the mounting screws for these two holes. Slide the enclosure onto these mounting screws so that the screws move up into the thinner section of the holes. Tighten the screws.
- Screw in the remaining two screws in either set of bottom mounting holes.
- Knock out the desired wire entrances on the enclosure.

2.2 Install the Control/Communicator



NO STATIC

The control is static sensitive. Make sure you touch earth ground before handling the control. This will discharge any static electricity in your body. Example: Run the ground wire to the enclosure before handling the control. Then keep holding the ground wire while installing the control.

- Insert the three support posts into the control retainer holes as shown in the diagram.
- Slide the top of the control into the retainer tabs (the slots under the top frame).
- Once in the retainer tabs, the control will rest on the three support posts.
- Secure the bottom of the enclosure by screwing the bottom three holes through the support posts and through to the control retainer holes.



IMPORTANT

Once the control is installed, be sure to connect its ground wire to the top hinge of the enclosure (the unpainted tab).

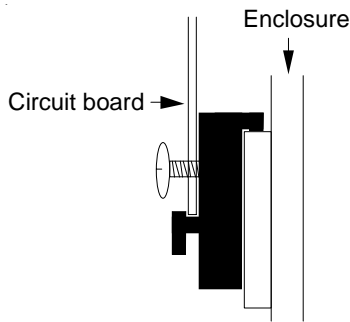

Support Post Assembly

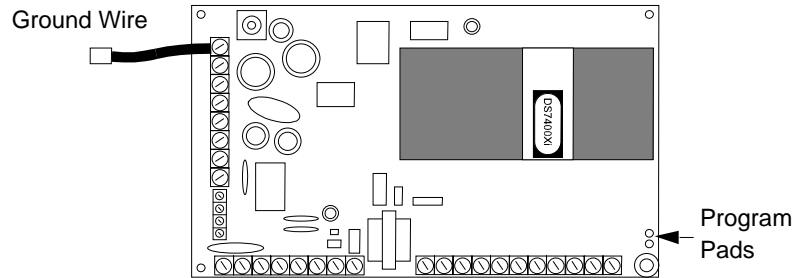

Control/Communicator

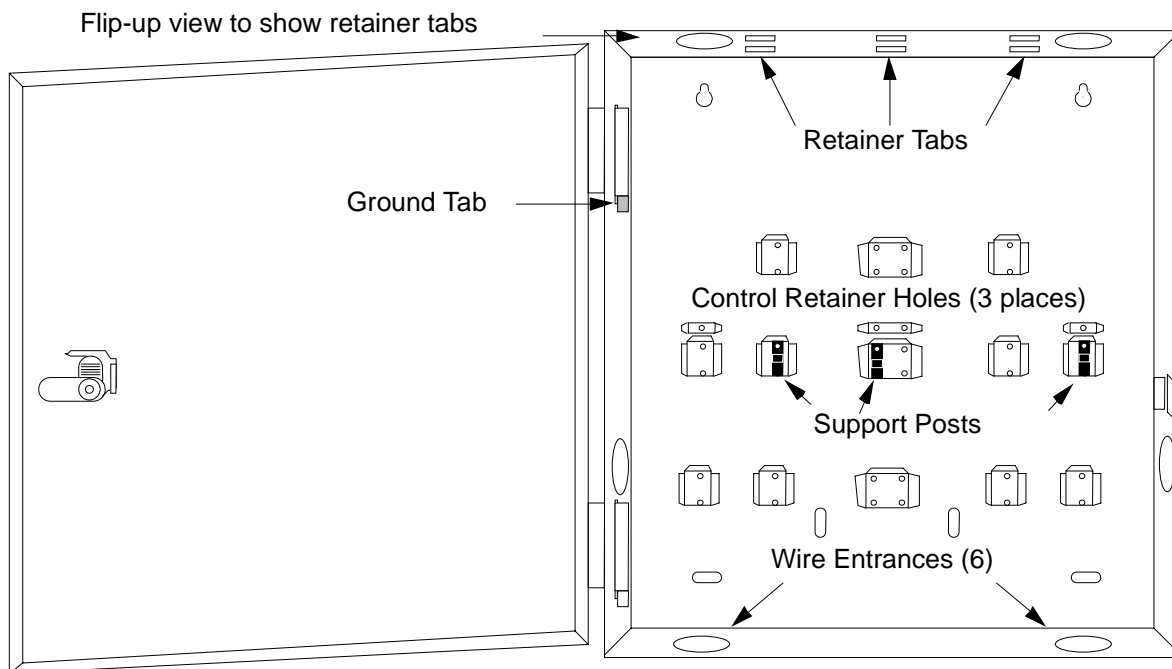

Enclosure

3.0 Control Terminal Wiring



WARNING

Before servicing, remove all power including the transformer, battery and phone line. A complete functional test is required after any programming.



CAUTION

Incorrect connections may result in damage to the unit.

System is Power Limited except for battery terminals. All wiring entering this enclosure must be power limited.

A/C Power Indication LED

1		EARTH GROUND: Must be connected to a good earth ground such as a cold water pipe and also connected to the cabinet cover, using the supplied wire jumper.
2		
3	A	AC INPUT: Use U. L. listed, 18 VAC 50 VA, class 2 transformer. Model TR-1850 requires 50/60 Hz. unswitched dedicated outlet - do not share.
4	C	
5	-	ALARM OUTPUT: Provides 12 VDC, special application, up to 1.75 A for powering bells, siren drivers, etc. Function programmed in address 0146.
6	A	
7	-	AUXILIARY POWER: Provides 12 VDC, special application, up to 1.0 A for powering detectors.
8	+	

R
B
G
Y
O
P
T
I
O
N

OPTION BUS:

Used for options such as the ARDIS communications module, the DS7420i Dual Phone Line module, etc. Also for keypads #11 - #15. For Commercial Fire Mode: Option Bus wiring should be in conduit if run outside the enclosure.

KEYPAD BUS*: Up to 15 keypads** may be used. Can be "home-run" or "daisy-chained."				PHONE LINE:			
R	B	G	Y	T	TH	RH	R
9	10	11	12	13	14	15	16

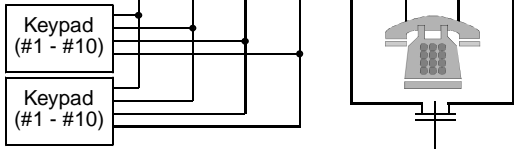

* = Maximum wire length each: 1000 ft. (305 m).
Maximum wire length total in system: 6000 ft. (1830 m) when using #22 AWG (0.8 mm) or #18 AWG (1.0 mm) cable.
** = Keypads #1 - #10 connect to the Keypad Bus and keypads #11 - #15 connect to the Option Bus.

TYPICAL BURGLAR AND FIRE WIRING

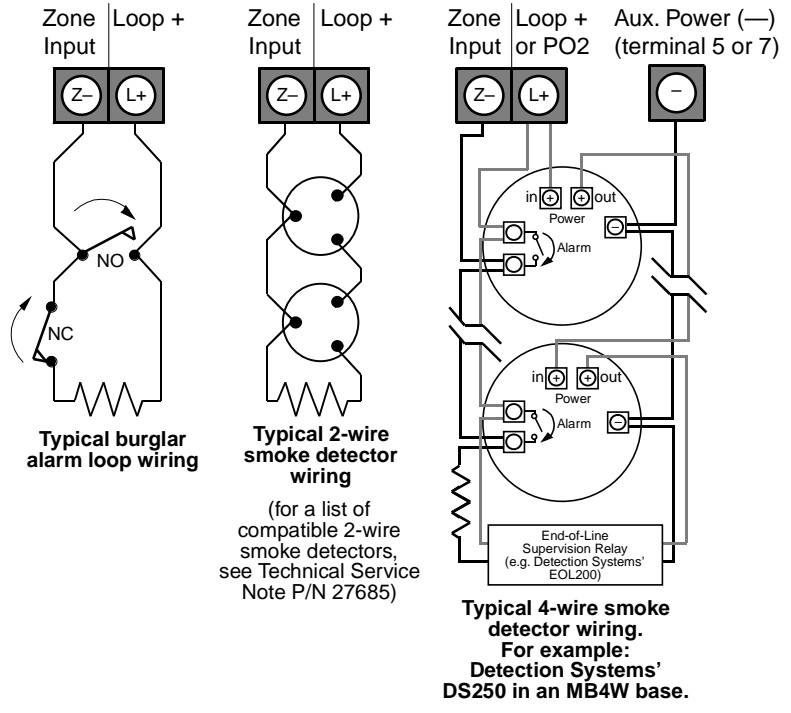

CAUTION

An appropriate two pole disconnect device must be installed by qualified service personnel, as part of the building installation.



CAUTION

Danger of explosion if battery is incorrectly replaced.
Replace with the same or equivalent type recommended by the manufacturer. Dispose of used batteries according to the manufacturer's instructions.

PROGRAMMABLE OUTPUTS:

PO1 shorts to aux. power negative when activated, PO1 can sink up to 1.0 A. PO1 function programmed in address 0147.
PO2 supplies 12 V and up to 500 mA when activated. PO2 function programmed in address 0148.

ZONES 1-8: Zones 1-8 are intended for connection of Normally Open or Normally Closed alarm contacts. They may also be used for compatible 2-wire smoke detectors. These zones require a 2.21KΩ resistor (P/N 25899) at the end of the loop. Power is momentarily removed from L+ after a [PIN] + [System Reset] or during a fire verification. Zone 1-8 assignments are programmed in address 0018-0025.

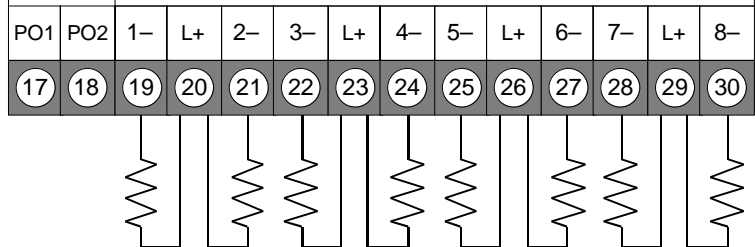

NOTE Shared cable is not recommended for keypad, multiplex, options bus, telephone, or siren wiring.

4.0 Hardware Layout Example

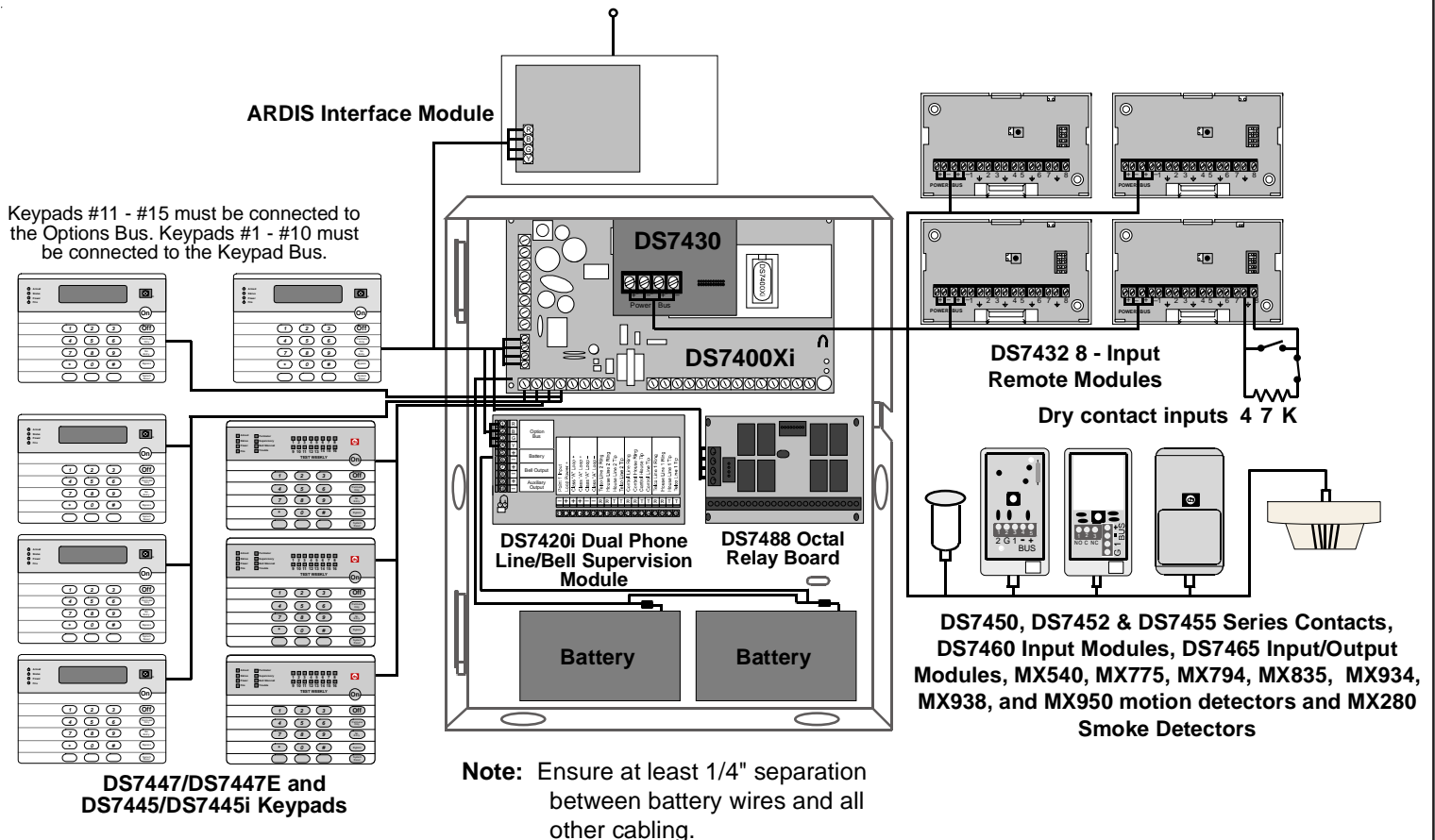

- Up to 15 keypads may be used. Keypads #1 - #10 connect to the Keypad Bus and Keypads #11 - #15 connect to the Option Bus. One keypad must be designated as keypad #1 and connected to the Keypad Bus. See the DS7447 and DS7445 Installation Instructions for further details.
- A DS7420i (Dual Phone Line/Bell Supervision Module) may be connected to the control panel, and placed within the enclosure. Connect to the Options Bus of the control panel. See the DS7420i Installation Instructions for further details.
- A DS7488 (Octal Relay Module) may be connected to the control panel, and placed within the enclosure. Connect to the Options Bus of the control panel. This provides an additional 8 Form "C" relay outputs for the control panel. See the DS7488 Installation Instructions for further details.
- A DS7430 (Multiplex Expansion Module) may be connected to the control panel via the expansion port. This will allow for the connection of additional zones. See the DS7430 Installation Instructions for further details.
- A DS7436 (Multiplex Expansion Module) may be connected to the control panel via the expansion port. This will allow for the connection of additional zones. See the DS7436 Installation Instructions for further details.
- Up to 15 DS7432s (8 Input Remote Modules) may be connected to the DS7430. Connect to the Power and Bus terminals of the DS7430. This allows for a means of addressing up to 120 input loops of conventional contacts to the control panel. See the DS7432 Installation Instructions for further details.
- A Communications Module may be connected to the control panel via the Options Bus. This allows for connection to the ARDIS radio network.
- Up to 128 zones are available for the connection of Single, Multiple, Input/Output, and Multiplex devices.

5.0 System Worksheet

Account Number _____ Information

Name _____ Contact Person _____
 Address _____ Voice Phone Number _____
 _____ Panel Phone Number _____
 City, State, Zip _____ Panel Answers Phone Armed Disarmed

Equipment Location and Notes

AC Voltage _____ VAC Battery Voltage _____ VDC AUX Current _____ A
 Battery Standby _____ AH Bell Current _____ A
 Control Panel _____
 Transformer _____
 Telephone Jack _____
 Telephone On Same Line as Panel _____
 Earth Ground Connection _____
 Alarm Sounder (s) _____

Misc. Notes

Keypad Location and Notes

Example

Location	Belongs to Partition	Master/Standard
Keypad # 1 Kitchen	2	Master

Location	Belongs to Partition	Master/Standard	Location	Belongs to Partition	Master/Standard
Keypad # 1			Keypad # 9		
Keypad # 2			Keypad # 10		
Keypad # 3			Keypad # 11		
Keypad # 4			Keypad # 12		
Keypad # 5			Keypad # 13		
Keypad # 6			Keypad # 14		
Keypad # 7			Keypad # 15		
Keypad # 8					

Personal Identification Number Information

Example
PIN Information

User #	Pin #	Auth. Level	Partitions	Name
002	1001	6	1, 2, 4	James L.

PIN Information

User #	Pin #	Auth. Level	Partitions	Name
001				
002				
003				
004				
005				
006				
007				
008				
009				
010				
011				
012				
013				
014				
015				
016				
017				
018				
019				
020				
021				
022				
023				
024				
025				
026				
027				
028				
029				
030				

PIN Information

User #	Pin #	Auth. Level	Partitions	Name
031				
032				
033				
034				
035				
036				
037				
038				
039				
040				
041				
042				
043				
044				
045				
046				
047				
048				
049				
050				
051				
052				
053				
054				
055				
056				
057				
058				
059				
060				

PIN Information

User #	Pin #	Auth. Level	Partitions	Name
061				
062				
063				
064				
065				
066				
067				
068				
069				
070				
071				
072				
073				
074				
075				
076				
077				
078				
079				
080				
081				
082				
083				
084				
085				
086				
087				
088				
089				
090				

5.0 System Worksheet (continued)

Zone Location and Notes

Example		
Type *	Zone/Output Function #	Partition & Location
Zone # 1 SZ	Zn Funct. 1	2, Kitchen

* = SZ: Single Zone Input
 MZ: Multiple Zone Input
 IO: DS7465
 (see section 11.2)

Type *	Zone/Output Function #	Partition & Location
Zone # 1		
Zone # 2		
Zone # 3		
Zone # 4		
Zone # 5		
Zone # 6		
Zone # 7		
Zone # 8		
Zone # 9		
Zone # 10		
Zone # 11		
Zone # 12		
Zone # 13		
Zone # 14		
Zone # 15		
Zone # 16		
Zone # 17		
Zone # 18		
Zone # 19		
Zone # 20		
Zone # 21		
Zone # 22		
Zone # 23		
Zone # 24		
Zone # 25		
Zone # 26		
Zone # 27		
Zone # 28		
Zone # 29		
Zone # 30		

Type *	Zone/Output Function #	Partition & Location
Zone # 31		
Zone # 32		
Zone # 33		
Zone # 34		
Zone # 35		
Zone # 36		
Zone # 37		
Zone # 38		
Zone # 39		
Zone # 40		
Zone # 41		
Zone # 42		
Zone # 43		
Zone # 44		
Zone # 45		
Zone # 46		
Zone # 47		
Zone # 48		
Zone # 49		
Zone # 50		
Zone # 51		
Zone # 52		
Zone # 53		
Zone # 54		
Zone # 55		
Zone # 56		
Zone # 57		
Zone # 58		
Zone # 59		
Zone # 60		

5.0 System Worksheet (continued)

Zone Location and Notes (continued)

Type *	Zone/Output Function #	Partition & Location
Zone # 61		
Zone # 62		
Zone # 63		
Zone # 64		
Zone # 65		
Zone # 66		
Zone # 67		
Zone # 68		
Zone # 69		
Zone # 70		
Zone # 71		
Zone # 72		
Zone # 73		
Zone # 74		
Zone # 75		
Zone # 76		
Zone # 77		
Zone # 78		
Zone # 79		
Zone # 80		
Zone # 81		
Zone # 82		
Zone # 83		
Zone # 84		
Zone # 85		
Zone # 86		
Zone # 87		
Zone # 88		
Zone # 89		
Zone # 90		
Zone # 91		
Zone # 92		
Zone # 93		
Zone # 94		

Type *	Zone/Output Function #	Partition & Location
Zone # 95		
Zone # 96		
Zone # 97		
Zone # 98		
Zone # 99		
Zone # 100		
Zone # 101		
Zone # 102		
Zone # 103		
Zone # 104		
Zone # 105		
Zone # 106		
Zone # 107		
Zone # 108		
Zone # 109		
Zone # 110		
Zone # 111		
Zone # 112		
Zone # 113		
Zone # 114		
Zone # 115		
Zone # 116		
Zone # 117		
Zone # 118		
Zone # 119		
Zone # 120		
Zone # 121		
Zone # 122		
Zone # 123		
Zone # 124		
Zone # 125		
Zone # 126		
Zone # 127		
Zone # 128		

6.0 Glossary

6.1 General Control Programming

- **Normal Arming** - [PIN] + [On]: If programmed, arms the entire system while allowing entry delays for entry/exit zones.
- **Perimeter Instant Arming** - [PIN] + [No Entry] [Perimeter Only]: If programmed, arms only the perimeter of the system and does not allow entry delays for entry/exit zones.
- **Perimeter Arming** - [PIN] + [Perimeter Only]: If programmed, arms only the perimeter of the system while allowing entry delays for entry/exit zones.
- **Custom Arming** - [PIN] + [#] [4]: If programmed, allows custom arming of the system and bypasses the zone functions specified in data address 0183.
- **Maximum Security Arming** - [PIN] + [No Entry] [On]: If programmed, arms the entire system and does not allow an entry delay for entry/exit zones.
- **General "Arm-Only" Authority by Partition**
A general (level 2) authority can be programmed to have arm-only authority by partition. This is done at addresses 0198 and 0199.
 - Arm-only access by partition allows someone with a General Authority to arm and/or bypass zones in a partition he can not disarm.
 - This level can still be used to arm, disarm, and bypass zones in the other partitions that it has access to.
- **Closing Ring-Back:** If programmed, the keypad sounders and Bell will activate for 2 seconds after the system is armed and the closing report is successfully sent. This requires Closing Ring-Back and Closing Report to be programmed.
 - If a closing report is not programmed, the control will test for a dial tone when the system is armed. If the test passes, the system will arm normally. If the test fails, the system will arm, but will indicate a trouble condition.
 - The DS7447/DS7447E keypad will display "Communication Err" after [#] [8] [7] is entered.
- **Siren on Comm. Fail for Silent Zone:** If programmed, a silent zone will sound the alarm outputs if the zone is in an alarm condition and the system fails to communicate with the central station.
- **Restore when Sounders Silence:** If programmed, a zone sends a restoral report and is ready to activate again only after the burglary bell cut-off time expires or the bells are silenced.
 - The zone can alarm multiple times per armed period.
- **Restore when Zone Restores:** If programmed, a zone sends a restoral report and is ready to activate again as soon as it physically restores.
 - This zone can alarm multiple times per armed period.
- **Restore when System Disarms:** If programmed, a zone sends a restoral report when the system is disarmed.
 - It can only alarm once per armed period.
- **Allow Swinger Shunts:** If programmed, a zone can only alarm or trouble up to three times per armed period. After the third alarm or trouble, the zone will be bypassed and a trouble report will be sent.

6.2 Zone Function Programming

• Zone Function

A Zone Function is the description of how a particular zone will behave (e.g. steady alarm output, bypassing allowed, alarm on

short, trouble on open, perimeter instant).

- Zone functions may be custom made, but 8 default zone functions already exist.
- There are many possible zone functions, but only up to 15 different zone functions are allowed per control.
- Each zone must be programmed as a specific zone function. Any number and combination of zones may be programmed as particular zone functions.
- **Invisible Alarms:** This is a zone programmed not to have an alarm output or an alarm display at any keypad when activated. An alarm signal will be sent, but the DS7447/DS7447E keypad display will read "Not Ready" while this zone is violated.
 - Invisible Alarm zones are recommended for holdup alarms.
- **Silent Alarms:** This is a zone programmed to activate the visual display at the keypad, but not audible signals.
 - If this zone is also an entry zone, an entry tone will sound when this zone is activated.
- **Bypassing Allowed:** This is a zone programmed to allow bypassing (shunting). This is done using the bypass command or the force-arming sequence.
- **Alarm on Short:** This is a zone programmed to activate an alarm when its loop is shorted.
- **Alarm on Open:** This is a zone programmed to activate an alarm when its loop is opened.
- **Trouble on Open:** This is a zone programmed to activate a trouble when its loop is opened and the system is disarmed.
 - If the system is armed, this zone will activate an alarm if shorted or opened.
 - For 24-hour zones, regardless of the arming state of the panel, this always remains as a Trouble on Open.
- **Trouble on Short:** This is a zone programmed to activate a trouble when its loop is shorted and the system is disarmed.
 - If the system is armed, this zone will activate an alarm if shorted or opened.
 - For 24-hour zones, regardless of the arming state of the panel, this always remains as a Trouble on Short.
- **Interior Delayed:** This is a zone programmed to be ignored during the entry/exit delay period. If it is violated when the system is armed, it will activate a delay for the programmed entry delay time. The keypad pre-alert sounders will activate and the system may be disarmed during this delay period. If the system is not disarmed during this delay period, this zone will activate an alarm. This zone is bypassed by Perimeter Instant or Perimeter Armed.
- **Perimeter Instant:** This is a zone programmed to activate an alarm even during the entry/exit delay period.
- **24-Hour:** This is a zone programmed to activate when its loop is faulted, even if the system is disarmed.
- **Entry/Exit Delay #1:** This is a zone programmed to be ignored during the entry/exit delay period.
 - If it is violated while the system is armed, it will activate a delay for the amount of time programmed for entry delay time #1 (address 0191). The keypad pre-alert sounders will activate and the system may be disarmed during this delay period.
 - If the system is not disarmed during the entry period, this zone will activate an alarm.
- **Entry/Exit Delay #2:** This is a zone programmed to behave identical to the Entry/Exit Delay #1 zone function except that it uses entry delay time #2 (address 0192).

NOTE If both entry delays have been activated, the control will use the shorter entry delay.

- **Entry/Exit Delay Cancel Zone Functions**

Entry/Exit Delay Cancel 1 and Entry/Exit Delay Cancel 2 Zone Functions cause the exit delay to expire as soon as the premises is vacated.

- If a zone is programmed as an Entry/Exit Delay Cancel zone, and it is activated during the exit delay, the exit delay will expire as soon as the zone has been restored.
 - Entry/Exit Delay Cancel 1 follows entry delay 1.
 - Entry/Exit Delay Cancel 2 follows entry delay 2.
 - They are programmed at addresses 0001-0015.
- **Interior Entry/Exit Follower:** This is a zone programmed to be ignored during an entry/exit delay and then become an interior instant zone.
 - If this zone is violated while the system is armed and no entry/exit zones have been violated, it will activate an alarm.
 - If this zone is violated after an entry/exit delay zone is violated, it will follow that entry/exit delay time.
 - This zone is bypassed by Perimeter Instant or Perimeter arming.
 - **Interior Home/Away:** This is a zone programmed to become an interior instant zone if the system is armed and an entry/exit delay zone is violated during the exit delay time.
 - If the system is armed and an entry/exit delay zone is not violated, this zone will be bypassed.
 - This zone is bypassed by Perimeter Instant or Perimeter arming.
 - **Interior Instant:** This is a zone programmed to activate an alarm even during the entry/exit delay periods.
 - It is bypassed by Perimeter Instant or Perimeter arming.
 - **Day Monitor:** This is a zone programmed to be a perimeter instant zone when the system is armed.
 - When the system is disarmed, any violation of this zone will activate the keypad sounders which will sound continuously until a disarm command sequence is entered.
 - The alarm outputs for this zone will not activate and there will be no report for this zone when the system is disarmed.
 - **Keyswitch Input:** This is a zone programmed to allow the system to be armed or disarmed using a Normally Open momentary keyswitch.
 - Outputs for keyswitch LEDs and sounders are available using the programmable outputs or the Octal relay outputs.
 - An output is needed for each LED and sounder.
 - A keyswitch will only control the partition that these zones are assigned to unless programmed as a master, then they will control all at once. See Program Address 0001, Data Digit 1.
 - Keyswitches and keypads may be used in the same partition, if desired.
 - **Fire Zone:** This is a zone programmed to activate if the system is armed or disarmed.
 - It can be silenced (not reset) by entering a valid [PIN] + [Off].
 - The display will indicate a Fire Alarm for this zone on all keypads in every partition.
 - A fire reset command must be entered after silencing the alarm to re-enable this zone.
 - If this zone is programmed for trouble and the loop opens, the DS7447/DS7447E keypad will display "Fire Trouble" and "Control Trouble". The keypad sounders will also beep once every ten seconds.
 - If the system is a combination fire and burglar alarm, the fire alarm has priority over the burglar alarm.
 - **Fire Zone with Verification:** This zone is identical to a Fire Zone except that after the first alarm, it will perform a fire reset and then wait up to two minutes for a second alarm.
 - If a second alarm occurs within this two minute period, the system will indicate a fire alarm.

- If there is no second alarm within this two minute period, the control panel will reset back to its normal condition.

NOTE Use of this control's alarm verification feature is not permitted for applications in the state of California.

- **Water Flow Zone:** This is a zone programmed to operate like a Fire Zone, but is specifically intended for water flow switches.
 - An optional retard timer can be programmed to compensate for changes in water pressure. If the timer is used, the water flow zone must be activated for the complete time period; an alarm will be initiated at the end of the timer period.
 - The maximum combined water flow delay of the control panel and the device must not exceed two minutes.

NOTE Any zone can be a water flow zone, but only zones 1 through 4 may be programmed as delayed water flow zones.

- **Supervisory Zone:** This is a zone programmed to accommodate shut-off valves.
 - It will indicate a supervisory condition at the keypads when activated.

6.3 Zone Programming

- **Zone**

A Zone is an input to the DS7400Xi Control/Communicator.

- There are 8 hardwired zones on the main circuit board.
 - Additional zones may be added by using the DS7433 (8 zone expansion module), the DS7430 (multiplex loop module), and/or other modules.
- **Single Zone Input:** This is an individual zone such as the on-board zones and multiplex contact zones.
 - **Multiple Zone Input:** This is a zone connected to one of the 8-Input Modules (DS7432 or DS7433) or to a Dual Zone Module (DS7460).
 - The inputs are programmed separately (see the separate Programming Addresses Worksheet, P/N 29802).
 - When using the Dual Zone Module (DS7460), loop A is always programmed as an odd numbered program address (ending in 1, 3, 5, 7, or 9). Loop B is the even numbered program address that follows loop A.
 - **DS7465:** This is the input zone or the output relay on a DS7465. The odd numbered zone is programmed for the input zone function and the even numbered zone is programmed for the output function.
 - **Multiplex Smoke:** This is a multiplexed input zone (zones 9-128) that is used with a MX280 series smoke detector. This zone must have a Zone Function of Fire Zone and Trouble on Open applied to the multiplex smoke zone.
 - **Multiplex Smoke with Low Temperature:** This zone is used with the MX280 series smoke detectors with a low temperature alarm. Making this selection requires the programming of two zones as follows:
 - **Smoke Alarm.** This must be the odd numbered zone of the zone pair required for these devices. The zone must be programmed with a zone function that is set for Fire Zone and Trouble on Open.
 - **Low Temperature Alarm.** This must be the even numbered zone of the zone pair required for these devices. This zone must be programmed with a zone function that is set as Supervisory and Trouble on Open.

6.4 Output Programming

- **Latch on Any Zone Alarm:** This is an output programmed to activate upon any zone alarm (including invisible zones) and will latch until the system has been disarmed.
 - If this output responds to a fire zone, it will remain latched until the fire reset command is performed.
- **ON during Entry Pre-Alert:** This is an output programmed to activate when an entry/exit zone is violated while the system is armed.
 - It will remain activated until the system is disarmed, or until the entry delay time has expired.
- **ON for 10 seconds** after [PIN] + [System Reset] is entered: This is an output programmed to activate for 10 seconds after the fire reset command is entered at the keypad or if a Fire Zone with Verification activates.
 - This output is intended to be used to power 4-wire smoke detectors or any other device that requires a power interruption to reset an alarm condition.

NOTE When Programmable Output 2 is programmed this way, it will normally supply auxiliary power and will turn OFF for 10 seconds when the fire reset command is entered.

- **ON when System is Armed:** This is an output programmed to activate when the system is armed.
 - **Armed Full:** If selected, only fully arming the system will activate the output.
 - **Armed Partial:** If selected, only the following arming conditions will activate the output: arming with bypasses, custom arming, force arming, any form of partial arming and perimeter arming.
 - **Armed Any:** If selected, any arming state will activate the output.
 - The output will remain activated until the system is disarmed.
- **Ground Start:** This is an output programmed to activate for 3 seconds when the phone line is seized. It is intended for use with ground start phone systems that require a momentary short to ground to obtain a dial tone.
 - Connect a separate 12 VDC, DPDT relay.
 - Connect both relay contact commons to ground, and connect the Normally Open of each contact to terminal positions 13 and 16 (one to terminal 13, the other to 16) of the DS7400Xi.
 - This output follows all partitions regardless of how data digit 2 of the output programming address is programmed.
 - Not intended for U. L. Listed systems. Not for use with phone line monitors.
- **System Status (ready to arm):** This is an output programmed to follow the Status LED of the keypad.
 - It will activate when the system is ready to arm with no zones violated.
- **Zone Alarm:** This is an output programmed to activate when a zone is in an alarm condition.
 - It will remain activated until the system is disarmed or the bell cut-off time expires.
 - This output is intended to activate alarm bells and sirens.
 - This will not activate from Silent or Invisible Zones.
- **Zone Alarm Delayed by 20 sec.:** This is an output programmed to wait 20 seconds after a zone enters an alarm condition to activate.
 - It will remain activated until the system is disarmed or the bell cut-off time expires.
 - This output is intended to activate alarm bells and sirens, but

provides a delay to allow the user to silence the system before it activates.

• Output Functions

Output Functions can be programmed to follow system events or to follow one or two specific zones in a “cross-matrix” fashion (see Input/Output Cross-Matrixing).

- These Output Functions can be programmed to control Octal Relay outputs or Multiplex Bus outputs.
 - Output Functions are programmed at addresses 1472 - 1516.
- ### • Input/Output Cross Matrixing
- Input/Output Cross Matrixing allows Output Functions to follow the status of specific input zones (zones 1 through 99 only).
- Outputs can be programmed to follow any combination of one or two zones, open or closed, with the system armed or disarmed.
 - If programmed to latch, the output will latch until a valid PIN is entered at the keypad.
- ### • Keypad Sounder Output:
- This is an output programmed to follow the keypad sounder.
- It activates during the entry pre-alert and during any day monitor alarm. It does not follow momentary keypad beeps such as keystrokes, chimes, etc.

- **Access Output:** This is an output programmed to activate for 10 seconds when an access control PIN is entered at the keypad.
 - Not U. L. Listed for Access Control (UL294).

- **Panic/Duress Output:** All outputs, including the three on-board outputs, the Octal Relays, and the Output Functions, support a Panic/Duress function. To assign an output as a Panic/Duress Output, program the first data digit as “*1”. Program data digit two for the appropriate partition(s). This output will follow Duress activations, Keypad Emergency Keys B and C, and Invisible and Silent Zone alarms. It will reset after being acknowledged by a user or after the burglary bell time-out expires.

• Multiplex Bus Outputs

The DS7400Xi supports up to 20 or 40 (when using a DS7436 Multiplex Module) DS7465 Input/Output Modules.

- These modules are connected to the multiplex bus and provide one input loop and one Form “C” output relay.
- The input loop operates the same as all other multiplex inputs.
- The output loop can be programmed to follow Output Functions.
- Multiplex Bus outputs can be bypassed using the bypass function. If an output zone is bypassed while it is ON, it will turn OFF. The bypass will not be removed when the system is armed and then disarmed; it must be cancelled by entering the bypass command again or by cancelling all bypasses.

NOTE DS7465 Module outputs will not pulse, even if programmed to do so.

• Octal Relay Modules (DS7488)

The DS7400Xi can support two Octal Relay Modules.

- Each relay can be programmed to follow system-wide events or Output Functions as described above.

• Solid State Output Modules (DS7489)

The DS7400Xi can support two Solid State Output Modules.

- Each output can be programmed to follow system-wide events or Output Functions as described above.

6.5 Partition Control Programming

- **Partition Control Programming:** Up to eight partitions may be used. They are assigned (program address 0165) in order.
 - For example: When using only one partition, it is partition one. When using three partitions, they are partitions one, two, and three.

- Partitioning allows the system to act as up to 8 different systems.
- Zones, keypads, outputs, and other items may be assigned to particular partitions.
- Access to partitions may be through each partition's keypad or through a Master keypad (see the operating section for more details).
- **Common Area:** Partition 1 can be programmed as a common area, that is, common to other partitions. This allows it to be used in an installation with one common entry area such as a foyer or vestibule.
 - When Partition 1 is programmed as a common area, it will only arm when all the partitions it is common to are armed.
 - The common area will disarm when any of the partitions it is common to are disarmed - only if the user has access to the common area.
 - When using a common area, a Master keypad should be used and assigned to the common area (see keypad assignment programming).

6.6 Keypad Assignment Programming

- **Keypad Assignment:** The keypad type and the partition it is assigned to must be programmed.
 - Each program address (0173-0180) programs the keypad type for two keypads. For example: data digit 1 of address 0173 is for keypad 1, data digit 2 of address 0173 is for keypad 2.
 - Each program address (0208-0215) programs the partition assignment for two keypads. For example: data digit 1 of address 0208 is for the partition assignment of keypad 1, data digit 2 of address 0208 is for the partition assignment of keypad 2.
 - Users must have access to the partition the keypad is assigned to in order to use the keypad.
- **Master Keypad Programming :** A Master keypad can be used to access all the partitions.
 - It will display the arm/disarm status of all the partitions and can be used to individually control each partition (see the operating section for an explanation of the keypad displays).
 - A Master keypad can be assigned to any of the partitions.
 - Any number of the 15 allowable keypads can be Master keypads.
 - When using the common area, it is suggested that a Master keypad be used and that it is assigned to the common area.

6.7 Emergency Key Programming

NOTE Do not label these keys if they are unprogrammed. Only the "A" key may be programmed and labeled as the Fire key. These keys are not intended to substitute for Listed manual pull boxes.

- **Fire Key:** The emergency key (key A) at the bottom left of the keypad entry area is the Fire Key. If programmed, the key will activate a fire alarm when pressed for 2 seconds.
 - It may be programmed for a steady or pulsed alarm.

NOTE The Fire Key will generate the fire alarm sounders in the partition that activated the Fire Key. Any other partitions in use will only have their keypad sounders activated. All keypad displays will be the same.

- **Special Emergency Key:** The emergency key (key B) at the bottom center of the keypad entry area is the Emergency Key.
 - If programmed, the key will activate a supplementary or an auxiliary type alarm when pressed for 2 seconds.
 - It may be programmed for a silent, steady, or pulsed alarm.
- **Panic Key:** The emergency key (key C) at the bottom right of the keypad entry area is the Panic Key.
 - If programmed, the key will activate a panic alarm when pressed for 2 seconds; the keypad display will not indicate an alarm.

- It may be programmed for a silent, steady, or pulsed alarm.

NOTE The Special Emergency Key and the Panic Key will generate the alarm sounders only in the partition of the keypad that activated that Key.

6.8 Custom Arming Programming

- **Custom Arming - [PIN] + [#] + [4]:** If programmed, the [PIN] + [#] + [4] command sequence may be used to custom arm the system by arming only certain zone functions.
 - For example: All interior zones plus some perimeter zones may be bypassed while leaving some of the perimeter armed.

6.9 Force Arming

- **Force Arming:** If programmed, allows violated zones to be force armed. When force arming, the user must enter the usual arming command followed by the [Bypass] key. This automatically bypasses zones that are violated and programmed as bypassable.
 - Fire zones, supervisory zones, keyswitch zones, and non-bypassable zones can not be force armed.
 - Not available in U. L. Listed systems.
 - See Program Address 0185.

6.10 Ground Fault Detect Programming

- **Ground Fault:** If programmed, this function will allow the system to detect ground faults. This function is required for fire panels and will be forced on when the panel is in the commercial fire mode.
 - See Program Address 0185.

6.11 Commercial Fire Mode Programming

NOTE In a system that includes both fire alarm and burglar alarm devices, the system must produce distinct sounds for fire and burglar alarm conditions either by using different indicating appliances or by using distinct cadences for the same appliance.

- **Commercial Fire Mode:** When in Commercial Fire Mode, the control panel will perform some functions (e.g. communications) differently to conform with commercial fire regulations.
 - See Commercial Fire Mode Programming, program address 0186.
- **Water Flow Zone Delay:** This is the amount of time a water flow zone must be violated before the control panel will initiate an alarm.
 - The delay is necessary to accommodate normal changes in water pressure.
 - If the water flow initiating device incorporates its own time delay, do not program the control panel unit to exceed 120 seconds combined time delay.
- **Pulsing Fire Zone:** This is a zone programmed to output a pulse for a fire alarm in the normal manner (one second ON, one second OFF).
- **California March Time:** This is a zone programmed to output a pulse for a fire alarm in the California Time cadence (ten 1/2 second pulses, followed by one second of quiet time).
- **Temporal:** This is a zone programmed to output a pulse for a fire alarm in the Temporal cadence (three 1/2 second pulses, followed by one second of quiet time).
- **Single Keypad Use:** The keypad should be used on the keypad bus and be mounted to the front of the control enclosure OR if within the same room as the control equipment with the wire run in conduit (or equivalently protected against mechanical injury) within 20 ft. (6.1 m) of the control equipment.
 - This keypad should be assigned as address 1.

- **Multiple Keypad Use:** One keypad only must be used on the option bus, at any address from 11 - 14, and must meet the following requirements:
 - The keypad must be mounted to the front of the control enclosure OR mounted within the same room as the control equipment. The wire is run in conduit (or equivalently protected against mechanical injury) within 20 ft. (6.1m) of the control equipment.
 - All other keypads should be connected to the keypad bus and may be placed as needed (within the noted wiring limitations in the installation manual).
 - One keypad must be assigned as address 1.

6.12 Open/Close Report Control Programming

- **Open and Close Reports:** If programmed, these reports are sent when the system is armed or disarmed. They may be sent independently for the opening and closing of each partition, or the first partition to open and the last partition to close may send the reports.
- **Alternate between both Phone Numbers:** If programmed, open and close reports will be sent to phone number one first. If phone number one does not pick-up, the control panel will alternate to phone number two. If phone number two does not pick-up, the control panel will alternate back to phone number one. It will alternate between both phone numbers until successful.

6.13 Report Programming

- **Reports:** For pulse formats, reports are programmed by entering data in the reporting and extended digits. The report will send the data programmed for each event. For SIA and Contact ID, the report formats are fixed and may be activated by placing a 1 in the reporting digit.
 - To disable a report, enter a 0 in the reporting digit.
 - To send the Man No. along with Open and Close reports, program an "F" (enter [*] [5] at the keypad) in the extended digit.
- **Keypad Fire Alarm:** This report is sent when a fire alarm has been activated by the "A" emergency key.
- **Keypad Fire Restoral:** This report is sent when a keypad fire alarm has been restored using the [System Reset] command.
- **Keypad Emergency Alarm:** This report is sent when an emergency alarm has been activated using the "B" emergency key.
- **Keypad Panic:** This report is sent when an emergency alarm has been activated using the "C" emergency key.
- **Keypad Tamper:** For keypads fitted with a wall tamper switch, this report is sent when the keypad is removed from the wall.
- **Keypad Tamper Restoral:** For keypads fitted with a wall tamper switch, this report is sent when the keypad is properly replaced on the wall after experiencing a tamper condition.
- **Zone Function Alarm:** An alarm report is sent when a zone alarm occurs. Alarm reports are enabled by zone function. Program this report for any zone functions you wish to send an alarm report about. For local zones (no reports), do not program an alarm report. The zone number will automatically be sent for this report in SIA or Contact ID format.
- **Zone Function Restoral:** This report is sent when the zone alarm is cleared. The zone number will automatically be sent for this report in SIA or Contact ID format.
- **Zone Function Trouble:** This report is sent when a zone trouble condition occurs. This can be an open circuit, if the zone is programmed for "trouble on open", a multiplex tamper switch being

activated, or a multiplex zone not communicating with the control panel. The zone number will automatically be sent for this report in SIA or Contact ID format.

- **Zone Function Trouble Restoral:** This report is sent when the trouble condition is cleared. The zone number will automatically be sent for this report in SIA or Contact ID format.
- **Zone Function Bypass:** This report is sent when a zone is bypassed. (Note: Fire zones can never be bypassed.) Zone bypass reports for non-24 hour zones are sent with the closing report. Bypass reports for 24 hour zones are sent when the zone is bypassed. If a zone is force armed, the bypass report is sent with the partial close report. If a 24 hour or non-24 hour zone is custom armed, the bypass report is sent with the partial close report.
- **Zone Function Bypass Restoral:** This report is sent when the zone bypass is cleared. For non-24 hour zones the bypass restoral is sent with the open report. Bypass restoral reports for 24 hour zones are sent when the zone is manually restored. The bypass restoral report for a zone that was force armed is sent when the zone is restored. If a 24 hour or non-24 hour zone was custom armed, the bypass restoral is sent with the open report.
- **Open:** This report is sent when the system has been disarmed. In SIA or Contact ID formats, the user number for the person who disarmed the system will be sent with this report. To send the user number along with an Open report in other formats, program the extended digit of the report as *5. In Contact ID format, the partition number will also be sent along with this report. The Open report will only be sent if a Close report was sent previously.
- **Close:** This report is sent when the system has been armed. In SIA or Contact ID formats, the user number for the person who armed the system will be sent with this report. To send the user number along with a Close report in other formats, program the extended digit of the report as *5. In Contact ID format, the partition number will also be sent along with this report.
- **Duress:** This report is sent when the system is disarmed using a duress code. The user number is not sent with this report.
- **Partial Close:** This report is sent when the system is armed partially, or force armed.
- **First Open After Alarm:** This report is sent when the system is disarmed after an alarm has occurred.
- **Low Battery:** This report is sent when a low battery condition occurs.
- **Battery Restoral:** This report is sent when a low battery condition restores.
- **AC Fail:** This report is sent when an AC failure condition occurs. This report may be delayed in address 0197.
- **AC Failure Report Delay**
The AC power loss report can be programmed to delay for up to 254 minutes (see address 0197). (The same delay would also apply to the AC restoral report.)
 - If another report is sent during this delay period, the AC fail report will be sent along with this report.
 - If the AC power restores during this delay period, the AC loss report will not be sent.
 - Programming address 0197 as FF causes the report to be sent at a random interval of at least 15 minutes, but no more than 2 hours after the AC failure occurs.
- **AC Restoral:** This report is sent when an AC failure condition restores.
- **Communicator Test/System Normal:** This report is sent at the

24-hour check-in time if there is not a control trouble, an active fire alarm that has not been acknowledged, a fire trouble, or a supervisory condition. Note: To send a Communicator Test even if one of these conditions exists, program the Communicator Test/System Off Normal.

- **Remote Program Successful:** This report is sent after a Remote Program session, if the session was terminated properly.
- **Remote Program Unsuccessful:** This report is sent after a Remote Program session, if some error has occurred or the session did not terminate properly.
- **Local Program Successful:** This report is sent when local programmer's mode is exited and there is no error associated with the programming.
- **Local Program Unsuccessful:** This report is sent when local programmer's mode is exited and there has been some error associated with the programming.
- **System Trouble:** This report is sent when a control trouble condition occurs.
- **System Trouble Restoral:** This report is sent when all system trouble conditions restore.
- **Communicator Test/System Off Normal:** This report is sent at the 24-hour check-in time if there is a control trouble, an active fire alarm that has not been acknowledged, a fire trouble, or a supervisory condition.
- **Exit Error:** This report is sent if an exit error occurs. An exit error occurs when an entry/exit zone is still violated at the end of the exit delay. If this happens, the entry delay will begin. If the system is not disarmed before the entry delay expires, an alarm report for the effected zone will be sent and the Exit Error report will be sent. If this report is not programmed, the control will not sound the exit error warning.
- **Recent Closing:** This report is sent, along with any alarm reports, when there is an alarm within the first five minutes after the system has been armed.
- **System Walk Test:** This report is sent when a system test has been started (#81 key sequence). Zone reports are sent during a system test.
- **System Walk Test Restoral:** This report is sent when the system test has been completed or has timed-out.
- **Fire Walk Test:** This report is sent when a Fire Walk Test has been started (#91 key sequence). Zone reports are not sent during a Fire Walk Test.
- **Fire Walk Test Restoral:** This report is sent when the Fire Walk Test has been completed or has timed-out.
- **Mux. Smoke Low Temperature Report:** This supervisory report is sent when a MX280 Series smoke detector with a low temperature feature detects a temperature of 45°F (7.5°C) or less for a period of 30 minutes or more.
- **Mux. Smoke Low Temperature Restoral:** This report is sent when a MX280 Series smoke detector with a low temperature alarm determines that the temperature has risen above 45°F (7.5°C).
- **Dirty Chamber Report:** This report is sent when a MX280 Series smoke detector fails to pass the "Chamber Check" sensitivity test.
- **Dirty Chamber Restoral:** This report is sent when a MX280 Series smoke detector has been returned to normal operation after service.

6.14 Phone Number General Control Programming

- **Enable Remote Programmer Callback:** If programmed, when the remote programmer tries to initiate a session with the panel, the panel will hang up and call the remote programmer phone number.
 - This ensures the correct remote programmer is initiating the call.
- **Dial Pulse on all Phone Numbers:** If programmed, the panel will use the pulse format to dial phone number 1, 2 and the remote programmer phone number 3.
- **Dial Tone on all Phone Numbers:** If programmed, the panel will use the tone format to dial phone number 1, 2 and the remote programmer phone number 3.

6.15 Phone Answering Programming

- **Answering Machine Bypass:** This feature allows the panel to answer incoming calls when answering machines are used. If the line rings, stops ringing, then rings again within one minute, the panel will seize the phone line on the first ring.
- **Phone Answering Programming:** The panel can be programmed to answer the phone after a selected number of rings for remote programming access. It can also be programmed to answer the phone after a different number of rings when in armed or disarmed states.
 - This can be used to call the panel location and determine its arming state.

6.16 FCC Compliance Notice

This equipment has been tested and found to comply with the limits for a Class A digital device, pursuant to Part 15 of the FCC Rules. These limits are designed to provide reasonable protection against harmful interference in a residential installation. This equipment generates, uses and can radiate radio frequency energy and if not installed and used in accordance with the instructions, may cause harmful interference to radio communications. However, there is no guarantee that interference will not occur in a particular installation. If this equipment does cause harmful interference to radio or television reception, which can be determined by turning the equipment off and on, the user is encouraged to try to correct the interference by one or more of the following measures:

- Re-orient or relocate the receiving antenna.
- Increase the separation between the equipment and the receiver.
- Connect the equipment into an outlet on a circuit different from that to which the receiver is connected.
- Consult the dealer or an experienced radio/TV technician for help.

6.17 FCC Phone Connection Notice To Users

This control complies with Part 68 of the FCC rules.

On the inside of the enclosure is a label that contains, among other information, the FCC Registration Number and the Ringer Equivalence Number (REN) for this equipment. You must, upon request, provide this information to your local telephone company. The REN is useful to determine the quantity of devices that may be connected to your telephone line and still have all of those devices ring when your telephone number is called. In most, but not all areas, the sum of the REN's of all devices connected to one line should not exceed five (5.0). To be certain of the number of devices that you may connect to your line, you may want to contact your local telephone company to determine the max. REN for your local calling area.

This equipment may not be used on coin service provided by the telephone company. This control should not be connected to party lines.

Should this equipment cause harm to the telephone network, the telephone company may discontinue your service temporarily. If possible, they will notify you in advance. But if advanced notice isn't practical, you will be notified as soon as possible. You will be informed of your right to file a complaint with the FCC. The telephone company may make changes in its facilities, equipment, operations, or procedures that could affect the proper functioning of your equipment. If they do, you will be notified in advance to give you an opportunity to maintain uninterrupted telephone service.

If you experience trouble with this equipment, please contact the manufacturer for information on obtaining service or repairs.

The telephone company may ask that you disconnect this equipment from the network until the problem has been corrected or until you are sure that the equipment is not malfunctioning. The repairs to this equipment must be made by the manufacturer and not the user.

To guard against accidental disconnection, there is ample room to mount the Telco jack to the inside of the Control cabinet.

The operation of this Control may also be affected if events such as accidents or acts of God cause an interruption in telephone service.

6.18 Canadian Dept. of Communications

General Installation Requirements: Notice: The Canadian Department of Communications label identifies certified equipment. This certification means that the equipment meets certain telecommunications network, protective, operational, and safety requirements. The Department does not guarantee the equipment will operate to the user's satisfaction.

Before installing this equipment, users should ensure that it is permissible to be connected to the facilities of the local telecommunications company. The equipment must also be installed using an acceptable method of connection. In some cases, the company's inside wiring associated with a single line individual service may be extended by means of a certified connector assembly (telephone extension cord). The customer should be aware that compliance with the above conditions may not prevent degradation of service in some situations.

Repairs to certified equipment should be made by an authorized Canadian maintenance facility designated by the supplier. Any repairs or alterations made by the user to this equipment, or equipment malfunctions, may give the telecommunications company cause to request the user to disconnect the equipment.

Users should ensure, for their own protection, that the electrical ground connections of the power utility, telephone lines, and internal metallic water pipe system, if present, are connected together. This precaution may be particularly important in rural areas.



Users should not attempt to make such connections themselves, but should contact the appropriate electric inspection authority, or electrician, as appropriate.

Terminal Requirements: The Load Number (LN) assigned to each terminal device denotes the percentage of the total load to be connected to a telephone loop which is used by the device, to prevent overloading. The termination on a loop may consist of any combination of devices subject only to the requirement that the total of the Load Numbers of all the devices does not exceed 100. The Load Number of the DS7400Xi is 2.

RFI Requirements: This Class A digital apparatus meets all requirements of the Canadian Interference-Causing Equipment Regulations. [Cet appareil numérique de la classe A respecte toutes les exigences du Règlement sur le matériel brouilleur du Canada.]

6.19 For Installations in New Zealand

Two-wire Connection:

The operation of this equipment on the same line as telephones or other equipment with audible warning devices or automatic ring detectors will give rise to bell tinkle or noise and may cause false tripping of the ring detector. Should such problems occur, the user is not to contact Telecom Faults Service.

7.0 Operating Guide

7.1 Personal Identification Numbers

7.1.1 General Information

When programming Personal Identification Numbers, it is helpful to know the following terms:

- **PIN:** Personal Identification Number. This is the 4 digit code users must enter at the keypad to gain access to the system. A PIN may be assigned to each User Number 001 through 090.
- **User Number:** This is the number that identifies each person using the system. There are 90 possible User Numbers available for use (001 through 090)
- **Authority Level:** This number determines which functions each user will be able to perform.

Your system has the capability to assign up to 90 PINs, each four digits long. Each User Number can have only one PIN assigned to it. Attempting to assign the same PIN to multiple User Numbers will result in the three-beep error tone, and the entry will not be made.

User Number 001 is designated as a Master code. It can be used to add, delete, or change other PINs. It will always have access to all partitions regardless of how it is programmed.

User Number 001 is shipped from the factory with the PIN of 1 2 3 4. This PIN should be changed to one of your personal preference and must be programmed as a Master code.

PINs should never be programmed with common sequences such as 1 2 3 4, 1 1 1 1, or 2 4 6 8 because they are easily violated.

7.1.2 Removing a PIN

To disable (remove) a PIN, enter:

- A [Master code], followed by [#] [0].
 - [0]
 - User number of the PIN to be cancelled, followed by [#]
- User Number 001 can not be disabled in this manner.

7.1.3 Authority Levels

- 0 = **Master:** Can enter all commands, add or change PINs in assigned partitions, change time and date, bypass, arm, disarm, perform system tests, system reset, and view history. Any or all PINs can behave as a Master code.
- 1 = **Unlimited:** Can enter all commands, bypass, arm, disarm, system reset, and perform system tests. Can not change PINs.
- 2 = **General:** Can bypass, arm, and disarm. Can not change PINs, system reset, or enter Command 7 or any of the Command 8 functions. Bypass and disarm are programmable by partition.
- 3 = **Arm Only:** Can arm the system with [On] arming only. Can not perform any other functions including disarming.
- 4 = **Temporary:** Valid only for a specified time (PIN will disappear upon expiration date). Can arm and disarm the system, but can not perform any other functions. If this function is performed from a Master Keypad, you must be in Single Partition Mode.
- 5 = **Duress:** When the system is disarmed using the duress PIN, a silent report is sent to the central station. The Duress PIN is intended to be used when the user is forced to disarm the system.
- 6 = **Access:** When a PIN with an Access code is entered, any output programmed for Access Output (e.g. door strikes) will pulse on for 10 seconds (works when the system is armed or disarmed).

NOTE: You must program a Temporary PIN's expiration date before programming the Temporary PIN.

This chart will guide you through the steps necessary to change a PIN.

It is recommended that this procedure be performed at a DS7447 keypad. No visual cues will be given from a DS7445 keypad.

Steps to Change a PIN	Command Sequence	If Accepted, the Display Reads
# 1. Enter the Master Code Programming Mode.	[Master Code] + [#] [0]	"0 User Change" (display will scroll to this)
# 2. Enter a 0.	[0]	"Enter User No." (001..0XX)
# 3. Enter the User Number.	[0] [0] [1] through [0] [9] [0]	"Enter Authority Level" Level (0-6)
# 4. Enter the Authority Level.	[0] through [6]	"Enter Area(s) or # for all"
# 5. Enter the Area(s) (partition(s)) this user has access to.	[1], [2], [3], [4], [5], [6], [7], and/or [8] then [#]	"Enter Next Area, End with #" or "Enter PIN"
# 6. Enter the PIN.	Any 4 digits. Do not press [#].	"Enter PIN Again. End with #" A long beep will sound to signify acceptance of the new PIN.
# 7. Enter the PIN again followed by the [#] key.	[PIN] (same 4 digits as above), then [#].	

7.2 Arming/Disarming Commands

For commands to Arm, Disarm, Bypass or set chime mode, see the front cover of this Reference Guide or consult the DS7400Xi Ver. 3+ User's Guide (P/N: 32781).

7.3 Changing the Date

This chart explains the procedure for changing the date at the keypad.

It is recommended that this procedure be performed at a DS7447 keypad. No visual cues will be given from a DS7445 keypad.

Steps to Change the Date	Command Sequence	If Accepted, the Display Reads
# 1. Enter the Master Code Programming Mode.	[Master Code] + [#] [0]	"2 Change Date" (display will scroll to this)
# 2. Enter a 2.	[2]	"Enter Month" (01...12)
# 3. Enter the Month.	[0] [1] through [1] [2] January December	"Enter Day." (01...31)
# 4. Enter the Day.	[0] [1] through [3] [1]	"Enter Year." (XX) End with #
# 5. Enter the Year.	The last two digits of the year, followed by the [#] key.	"Month, Day, Year" A long beep signifies acceptance.

Note: Entering the command sequence [Master Code] [#] [0] [2] [#] will cause the DS7447 keypad to read back the date. The control panel will exit you from the master code programming mode after about 15 seconds without a keystroke.

7.4 Changing the Temporary PIN Expiration Date

This chart explains the procedure for changing the expiration date (for temporary PINs) at the keypad.

It is recommended that this procedure be performed at a DS7447 keypad. No visual cues will be given from a DS7445 keypad.

Steps to Change the Exp. Date for Temp. PINs	Command Sequence	If Accepted, the Display Reads
# 1. Enter the Master Code Programming Mode.	[Master Code] + [#] [0]	"3 Change Date of Code Expiration"* (display will scroll to this)
# 2. Enter a 3.	[3]	"Enter Month" (01...12)
# 3. Enter the expiration Month.	[0] [1] through [1] [2] January December	"Enter Day." (01...31)
# 4. Enter the expiration Day. <i>The temporary PIN will expire at Midnight on the day selected.</i>	[0] [1] through [3] [1]	"Enter Year." (XX) End with #
# 5. Enter the expiration Year.	The last two digits of the year, followed by the [#] key.	"Month, Day, Year" A long beep signifies acceptance.

* = This will only display when in Single Partition Mode.

Note: Entering the command sequence [Master Code] [#] [0] [3] [#] will cause the DS7447 keypad to read back the temporary code expiration date.

The control panel will exit you from the master code programming mode after about 15 seconds without a keystroke.

7.5 Changing the Time

This chart explains the procedure for changing the time at the keypad.

It is recommended that this procedure be performed at a DS7447 keypad. No visual cues will be given from a DS7445 keypad.

Steps to Change the Time	Command Sequence	If Accepted, the Display Reads
# 1. Enter the Master Code Programming Mode.	[Master Code] + [#] [0]	"6 Change Time"* (display will scroll to this)
# 2. Enter a 6.	[6]	"Enter Day" (1...7)
# 3. Enter the day.	[1] through [7] Sunday Saturday	"Enter Time." (0100...1259)
# 4. Enter the Time. (Hour and minute)	[0] [1] [0] [0] through [1] [2] [5] [9]	"Enter AM/PM." (4/6) End with #
# 5. Enter AM or PM.	[4] [#] or [6] [#] (4=AM, 6=PM)	"Day - Time" A long beep signifies acceptance.

* = This will only display when in Single Partition Mode.

Note: Entering the command sequence [Master Code] [#] [0] [6] [#] will cause the DS7447 keypad to read back the time.

The control panel will exit you from the master code programming mode after about 15 seconds without a keystroke.

7.6 Delayed Arming

This section explains how to cause the system to arm after a specified number of hours.

To program the system for delayed arming, perform the following steps:

Delayed Automatic Arming	Notes
Enter a PIN	
Enter [#] [9] [9] to enter the Delayed Arming programming	The keypad will display the following: Arm in nn Hours # to accept
Enter the number of hours to delay arming. Enter using [0] [1] [#] format	Enter the number of hours from now that you would like the system to arm. For example: If it is 3:30 now, and you would like the system to arm at 9:30, enter [0] [6] [#].

Additional Notes:

Delayed arming can be used even if there are no automatic arming times programmed.

If delayed arming is used in Master Keypad mode, it will affect all partitions you have access to. If delayed arming is used in single partition mode, or from a single partition keypad, it will affect only the partition you are working in.

Delayed arming will override automatic arming.

Delayed arming will also provide a 30 minute pre-arm period like the one provided with automatic arming.

7.7 Automatic Arming

Each partition can be programmed to automatically arm once per day.

To inform occupants that the system is about to arm, a pre-arming period will begin 15 minutes before the system arms automatically. The keypad sounders, and any outputs programmed to follow the keypad sounders, will pulse five times every minute if programmed to do so in Program Address 0202-0205. During the last five minutes before arming, these sounders will be on steady. Once per minute the keypad will read, "Arm in nn min./PIN + OFF - extend."

If automatic arming is used in Master Keypad mode, it will affect all partitions you have access to. If used in single partition mode, or from a single partition keypad, it will affect only the partition you are working in.

To program the Automatic Arming Time, perform the following steps:

Setting the Automatic Arming Time	Notes								
Enter a [Master PIN] + [#] + [0]	Setting the Automatic Arming Time can only be performed in the Master Programming Mode.								
Enter a [1] to enter the Automatic Arm Setup programming									
Enter the partition number. Press [#] to exit.	If programming is done from a Master Keypad that is not in single partition mode, the user will be prompted to enter the partition they wish to program. The user will only be allowed to program the partitions to which they are assigned. If programming from a standard keypad, or from a Master Keypad in single partition mode, this step will be skipped.								
Enter a time for each day. Enter in [0] [1] [0] [0] [#] format.	The display will start with Sunday. It will read, "Sunday - nn : nn" Enter the time in 24 hour format then press the [#] key. If you make a mistake, press the [*] key twice to move back to your last entry. Samples of times: <table border="0" style="width: 100%;"> <tr> <td style="width: 50%;">12 midnight = 2400#</td> <td style="width: 50%;">12 noon = 1200#</td> </tr> <tr> <td>12:01am = 0001#</td> <td>12:01pm = 1201#</td> </tr> <tr> <td>1:00am = 0100#</td> <td>1:00pm = 1300#</td> </tr> <tr> <td>Disabled = 0000#</td> <td></td> </tr> </table>	12 midnight = 2400#	12 noon = 1200#	12:01am = 0001#	12:01pm = 1201#	1:00am = 0100#	1:00pm = 1300#	Disabled = 0000#	
12 midnight = 2400#	12 noon = 1200#								
12:01am = 0001#	12:01pm = 1201#								
1:00am = 0100#	1:00pm = 1300#								
Disabled = 0000#									

To extend the Automatic Arming of the system during the automatic arming pre-arming period by 30 minutes from the time of command entry, enter [PIN] + [OFF]. For a longer delay, perform the following steps:

Delayed Automatic Arming	Notes
Enter a PIN	
Enter [#] [9] [9] to enter the Delayed Arming programming	The keypad will display the following: Arm in nn Hours # to accept
Enter the number of hours to delay arming. Enter using [0] [1] [#] format	Enter the number of hours from now that you would like the system to arm. For example: If it is 3:30 now, and you would like the system to arm at 9:30, enter [0] [6] [#].

To extend the Automatic Arming at any time, use the Delayed Arming feature (see section 7.6).

7.8 Turning OFF the System under Duress

This chart explains the proper procedure for disarming under Duress.

Ask your installer if the Duress feature has been activated.

A Duress code is used when someone demands, by threatening your life or well-being, that the system be turned off. When used, the code will both turn off the system and report a silent Duress alarm if connected to a monitoring service.

Extreme care should be used when entering your PIN to turn off the system, so a Duress code is not inadvertently entered.

Type of Disarming	Command Sequence	What will Happen
Disarming System under Duress	[Duress Code] + [Off]	System will appear to disarm normally. A Duress code will be sent to the central station.

7.9 Automatic Disarming

Each partition can be programmed to automatically disarm once per day.

If automatic disarming is used in Master Keypad mode, it will affect all partitions you have access to. If used in single partition mode, or from a single partition keypad, it will affect only the partition you are working in.

To program the Automatic Disarming Time, perform the following steps:

Setting the Automatic Disarm Time	Notes								
Enter a [Master PIN] + [#] + [0]	Setting the Automatic Disarm Time can only be performed in the Master Programming Mode.								
Enter a [4] to enter the Automatic Disarm Setup programming									
Enter the partition number. Press [#] to exit.	If programming is done from a Master Keypad that is not in single partition mode, the user will be prompted to enter the partition they wish to program. The user will only be allowed to program the partitions to which they are assigned. If programming from a standard keypad, or from a Master Keypad in single partition mode, this step will be skipped.								
Enter a time for each day. Enter in [0] [1] [0] [0] [#] format.	The display will start with Sunday. It will read, "Sunday - nn : nn" Enter the time in 24 hour format then press the [#] key. If you make a mistake, press the [*] key twice to move back to your last entry. Samples of times: <table border="0"> <tr> <td>12 midnight = 2400#</td> <td>12 noon = 1200#</td> </tr> <tr> <td>12:01am = 0001#</td> <td>12:01pm = 1201#</td> </tr> <tr> <td>1:00am = 0100#</td> <td>1:00pm = 1300#</td> </tr> <tr> <td>Disabled = 0000#</td> <td></td> </tr> </table>	12 midnight = 2400#	12 noon = 1200#	12:01am = 0001#	12:01pm = 1201#	1:00am = 0100#	1:00pm = 1300#	Disabled = 0000#	
12 midnight = 2400#	12 noon = 1200#								
12:01am = 0001#	12:01pm = 1201#								
1:00am = 0100#	1:00pm = 1300#								
Disabled = 0000#									

7.10 Emergency Procedures

7.10.1 Identifying Alarm Sounds

Your alarm system may be programmed for a steady alarm sound or a pulsed alarm sound. It is important to learn the difference between a fire alarm sound and an intrusion alarm sound before you are confronted with an actual emergency.

7.10.2 Silencing Alarms

All alarms can be silenced with any PIN that has disarm privileges. Entering your [PIN]+ [Off] will silence the alarm and turn off (disarm) the control.

7.10.3 A Cautionary Note

How you respond to an alarm will depend, mostly, on the type and time of the alarm. You should seek the advice of your installing company as they install your system, not later (i.e. after an alarm) to develop a response plan.

7.10.4 Use Common Sense

Above all else, common sense should prevail. If there is any threat or hint of danger to yourself or others on the premises, such as in the event of a fire alarm, everyone should be instructed to leave the premises immediately. Do not enter the premises unless

accompanied by the appropriate Emergency Services' personnel, or after they have given the OK to enter.

7.10.5 Caution When Entering A Building

An alarm has occurred if:

- The bells and sirens are on, and/or
- The red Armed Light is flashing with the DS7447/DS7447E display reading "Zone Alarm"
- The DS7445/DS7445i zone LEDs 1-16 are flashing.

The keypad will also issue a pulsed tone during the entry delay instead of the usual steady tone.

If the alarm has not been previously investigated, do not enter the building unless accompanied by the appropriate Emergency Services' personnel.

7.10.6 Fire Alarms

Fire Alarms are silenced using the same procedure as intrusion alarms: a [PIN] (with disarm privileges) + the [Off] key.

The Fire Alarm system is not reset until alarms at smoke detectors are cleared by using the [System Reset] command. The Fire Alarm system will not be functional until this procedure has been followed. See the "Fire Reset" section, 7.11.1.

7.11 Fire Reset/Fire Trouble

7.11.1 Fire Reset

During a fire alarm, exit the premises immediately. When you have determined there is no fire, you may silence the bells/sirens before you initiate the [System Reset] command: [PIN] + [System Reset]. Before the [System Reset] command is used, determine which smoke detector has alarmed so the monitoring company may verify its operation.

NOTE To use the System Reset command sequence, your PIN must have disarm privileges. The System Reset command will perform a fire reset, a battery test, and will clear all system troubles.

NOTE If the System Reset command has not been performed after 24 hours of the Fire Alarm, the keypad will sound and it will display "Fire Alarm Not Reset." If the sounders have been silenced and the system has been reset properly, this warning will not occur.

7.11.2 Fire Trouble

A Fire Trouble message with a zone number signifies a problem with the fire system, such as a break in the wiring that monitors

smoke detectors. A Fire Trouble message with no zone number indicates a ground fault if the unit is in the commercial fire mode.

A Fire Trouble will be indicated by a short beep from the keypad sounders every 10 seconds. The DS7447/DS7447E will display "Fire Trouble" followed by the zones in a trouble condition. The DS7445/DS7445i will turn the Fire and Trouble Lights on steady and will light the corresponding zone LEDs.

Notify your installing company immediately if the Fire Trouble message is displayed.

The Fire Trouble beep can be silenced with any [PIN] followed by the [Off] key. After problems have been remedied, [PIN] + [Off] should again be entered to clear the "Fire Trouble" display.

7.11.3 Dirty Smoke

A Dirty Smoke display, followed by a zone number and accompanied by a beep every ten seconds indicates that the smoke detector for that zone requires cleaning or replacement. The smoke detector will also give a Dirty indication by flashing its LED once per second.

The Dirty Smoke beep can be silenced with any [PIN] followed by the [Off] key.

Notify your installing company immediately if the Dirty Smoke message is displayed.

7.12 Emergency Keypad Alarms

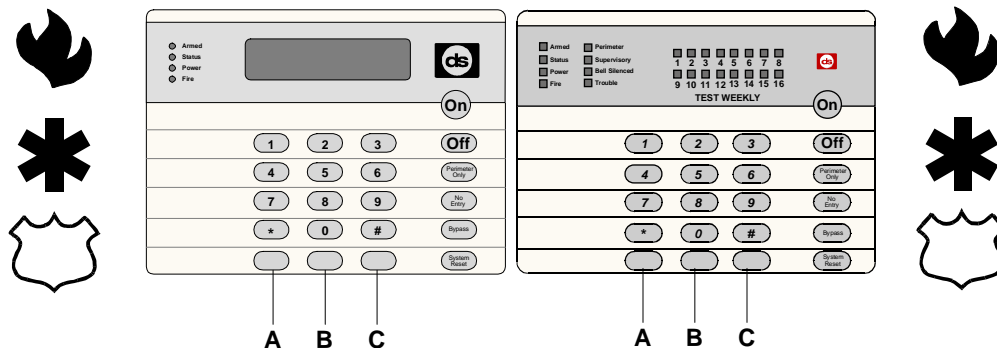

The Emergency Alarm Keys [A], [B], and [C] may generate Fire, Special Emergency, and Panic Alarms if programmed by the installer. Ask your installing company to explain the function of these keys.

When using the Emergency Keys, they must be pressed for two seconds to generate an alarm.

NOTE If the Emergency Alarm Keys are to be used, they should be labeled to signify their functions. The A key should be labeled as the Fire key. This is the only key that may be designated as the Fire key. The B key should be labeled as the Special Emergency key. The C key should be labeled as the Panic key.

Use the Disarming Command Sequence [PIN] + [Off] to cancel or silence these alarms.

7.13 Fire Safety



No fire detection device or system should be considered 100% foolproof.



This fire alarm system can provide early warning of a developing fire. Such a system, however, does not ensure protection against property damage or loss of life resulting from a fire. Any fire alarm system may fail to warn for any number of reasons (i.e. smoke not reaching a detector that is behind a closed door).

When considering detectors for residential applications, refer to NFPA Standard 72, "The National Fire Alarm Code." This standard is available at a nominal cost from: The National Fire Protection Association, Batterymarch Park, Quincy, MA 02269.

7.13.1 If Installed in Family Residences

Adherence to the NFPA Standard 72 can lead to reasonable fire safety when the following items are practiced:

- Minimize hazards: Avoid the three traditional fire killers: smoking in bed, leaving children home alone and cleaning with flammable liquids.
- Providing a fire warning system: Most fire deaths occur in the home, the majority during sleeping hours. The minimum level of protection requires smoke detectors to be installed outside of each separate sleeping area and on each additional story of the dwelling.

For added early warning protection, it is recommended that detectors be installed in all separated areas including the basement, bedrooms, dining room, utility room, furnace room, and hallways.

7.13.2 Having and Practicing an Escape Plan

A fire warning may be wasted unless the family has planned in advance for a rapid and safe exit from the building.

- Draw a floor plan of the entire house showing two exits from each bedroom and two from the house. Since stairwells and hallways may be blocked during a fire, the plan should provide exits from bedroom windows.

Make copies of the plan and practice it with all family members.

- Pre-arrange a meeting place outside and away from the residence. Once out of the building, all occupants should immediately go to the pre-selected location to be accounted for.
- Provide a barricade between family members and fire, smoke, and toxic gases (e.g. close all bedroom doors before retiring).
- Children should be instructed on opening their bedroom windows and exiting safely from the building. If exiting is not possible, they should be taught to stay at the open window and shout for help until it arrives.
- In the event of a fire alarm after retiring, wake the children by shouting to them from behind your closed door. Tell them to keep their bedroom doors closed.
- If the top of your bedroom door is uncomfortably hot, do not open it. There is most likely fire, intolerable heat, or smoke on the other side. Shout to all family members to keep their bedroom doors closed and to exit the building via alternate routes.
- If the top of the door is not uncomfortably hot, brace the bottom of the door with your foot, and the top with one hand, then open the door about one inch. Be prepared to slam the door shut if there is any pressure against the door or if any hot air rushes in.
- If there is no evidence of excessive heat or pressure, leave the room and close the door behind you. Shout appropriate instructions to all family members and immediately leave the building via the pre-planned routes. If heavy smoke is present, drop to your hands and knees, or crawl to remain below the smoke level.

7.13.3 Installation Considerations

Proper location of detection devices is one of the most critical factors in a fire alarm system.

The following are some general considerations:

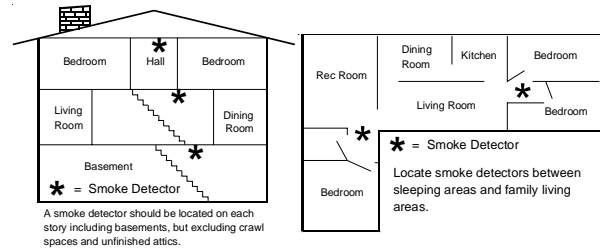

- Smoke detectors should not be installed in “dead air” spaces or close to ventilating or air conditioning outlets because smoke may be circulated away from the detector. Locations near air inlets should be favored.
- Avoid areas subject to normal smoke concentrations such as kitchens, garages, or near fireplaces.
- Do not install smoke detectors where normal area temperatures are above 100 degrees F (38 degrees C) or below 32 degrees F (0 degrees C).
- Areas of high humidity and dust concentrations should be avoided.
- The edge of ceiling mounted detectors should be no closer than 4 inches (10 cm) from any wall.
- Place the top edge of wall mounted detectors between 4 and 12 inches (10 to 30 cm) from the ceiling.

7.14 Testing

7.14.1 System Walk Test

The System Walk Test is used to confirm that detectors will report alarms. System Walk Test works on all zones, except 24-hour zones and fire zones. At the start of the System Walk Test a System Walk Test report, if programmed, is sent to the central station, followed by reports from the individual zones as they are tested. A System Test restoral is sent upon completion of the System Walk Test. If System Walk Test Report, Address 0339, and System Walk Test Restoral, Address 0340, are not programmed, no zone reports are sent during the System Walk Test.

Type of Test	Command Sequence	What will Happen	What to Do
System Walk Test	PIN + [#] [8] [1]	<p>DS7447: “Test Zone” will display followed by the zone number of any zones that have not been tested.</p> <p>DS7445: The Zone LEDs will flash for any zones that have not been tested.**</p> <p>DS7447: “Now Testing” will be displayed followed by the zone number of the zone that is currently being violated (being tested). It returns to “Test Zone” after the violation.</p> <p>DS7445: The Zone LED will turn on steady for the zone that is currently being violated (tested).</p>	<p>Test each detector one at a time as instructed by the installing company.</p> <p>To exit the Zone Test mode, enter your [PIN] + the [#] key.</p>

Note: This test may be performed from a Master Keypad in the Single Partition Mode.

** Zones 1-8 only will be displayed on a DS7445 keypad.

7.14.2 Fire Walk Test

The Fire Walk Test is used to confirm that Smoke detectors will report alarms to the keypads. The Fire Walk Test tests all fire zones, including verified fire and waterflow. At the start of the Fire Walk Test a Fire Walk Test report, if programmed, is sent to the central station. Fire alarm reports are not sent to the central station during the Fire Walk Test. A Fire Walk Test restoral is sent upon completion of the Fire Walk Test. The Fire Walk Test is enabled for 20 minutes once it is started. The test time is extended to 20 minutes every time another zone is tested. When a fire zone is tested, any output programmed to follow that zone will activate for 5 seconds.



A Fire Walk Test will prevent the system from sending any Fire Reports during the test.

Type of Test	Command Sequence	What will Happen	What to Do
Fire Walk Test	[PIN] + [#] [9] [1]	<p>DS7447/DS7447E: "Fire Test" will display followed by the zone number of any zones that have not been tested.</p> <p>DS7445/DS7445i: The Zone LEDs will flash for any zones that have not been tested. **</p> <p>DS7447/DS7447E: "Fire Testing" will display followed by the zone number of any zones that is currently being violated (being tested). It returns to "Fire Test" after the violation.</p> <p>DS7445/DS7445i: The Zone LEDs will turn on steady for the zone that is currently being violated (tested).</p>	<p>Test each detector one at a time as instructed by the installing company.</p> <p>To exit the Zone Test mode, enter you [PIN] followed by the [#] key.</p>

** Zones 1-16 only will be displayed on a DS7445/DS7445i

7.14.3 Battery/Sounder Test

If a power failure occurs, your control panel has a built-in battery that will continue to power the control panel for several hours. The control panel automatically recharges the battery when power is restored. In addition to an automatic battery test performed every 2 minutes, the battery may also be tested manually. This test also uses the battery to manually activate all the system sounders for 2 seconds ([#] [8] [5] only). If the battery voltage is low, a battery fault will occur (see Error Display).

Type of Test	Command Sequence	What will Happen	What to Do
Local Battery/Sounder Test *	[PIN] + [#] [8] [5]	<ul style="list-style-type: none"> All keypad Lights will turn on. The keypad sounder and all alarm sounding devices will operate for 2 seconds. 	<p>If test fails, the control will indicate a Control Problem. See Error displays, section 7.14.7.</p> <p>If power in your building has been off recently, wait 2 hours for the battery to recharge and then try again.</p>
Battery Test	[PIN] + [System Reset]	<ul style="list-style-type: none"> The control will perform a Battery Test. The control will report a Low Battery or a Low Battery Restoral if necessary. 	

* = **Note:** If this test is performed from a Master Keypad, it must be in Single Partition Mode.

7.14.4 Communicator Test

This test is available only if your system transmits alarms and system information to a monitoring service, and has been programmed by the security installing company to permit communicator tests. A long beep will initially sound to acknowledge the start of the test. If the test is successful, the sounder will again issue one long beep. If the test fails, the keypad sounder will turn ON continuously. To silence the sounder, enter your [PIN] followed by the [#] key or press the [*] key. This test can be performed from a Master Keypad. The account code for partition #1 will be used.

Type of Test	Command Sequence	What will Happen	What to Do
Communicator Test Requires addresses 0329, 0496, 0529, and 1521 to be programmed.	[PIN] + [#] [8] [2]	<ul style="list-style-type: none"> • A long beep will sound. • A "Test" report is sent to the monitoring service. 	If test fails, the keypad sounder will sound continuously. To silence the sounder, press the [System Reset] key. Note: This test may take several minutes to complete as the control will try 10 attempts (not programmable) before it fails this test.

7.14.5 Event History Readback

The History Buffer stores the last 400 events in memory, the most recent 64 are stored in non-volatile memory (will be kept even if total power loss). The DS7447/DS7447E can display all of these events. The DS7445/DS7445i will only display those zones that have alarmed since the last Event History Readback.

Type of Test	Command Sequence	What will Happen	What to Do
Event History Readback*	[PIN] + [#] [8] [9]	DS7447/DS7447E: The last event to take place will be displayed. DS7445/DS7445i: The zone LEDs will flash for any zones that have alarmed since the last Event History Readback done on a DS7445/DS7445i keypad in that partition. For system fault displays, see Section 7.14.7.	For the DS7447/DS7447E, scroll through the events by using the [9], [6], and [#] keys. To exit from the Event History Mode, press the [*] key.

* = If this test is performed from a Master keypad, it must be in Single Partition Mode.

DS7447/DS7447E Only: Scrolling through the History Events.

To begin scrolling back through the events, press the [#] key. The [#] key will scroll you back through the history line by line. The [9] key will scroll you back in reverse chronological order by event. The [6] key will scroll you back up through the events (toward the most recent) by event.

Each event consists of two or three lines or display screens. The first line/screen will be the event title and user. The second line/screen will be the date of the event or the change being made. If there is a third line/screen, it will be the date of the change.

To exit the Event History Mode, press the [*] key or wait 20 seconds and the keypad will exit automatically.

When performing this from a Master Keypad, each partition will display its own history.

7.14.6 Remote Program Dial-out and Answer

Type of Function	Command Sequence	What will Happen
Remote Program Dial-out*	[PIN] + [#] [8] [3]	The panel will call the remote programmer.
Remote Program Answer	[PIN] + [#] [8] [6]	The panel will answer a call from the remote programmer.

*= Phone numbers 1 and 3 must be programmed and an Account Code must be programmed.

7.14.7 Error Displays/Warnings

This section explains the procedure for reading Error displays and Warnings.

Control Panel Errors are indicated by a flashing green Power Light. The DS7447/DS7447E display will also read “**Control Trouble, Enter #87.**” The DS7445/DS7445i will only flash the green Power Light. The Error displays may only be read when the control is disarmed. Control Panel Errors will send a “System Trouble” report if it is programmed.

Control Panel Warnings are indicated by a display message on the DS7447/DS7447E keypad and a keypad beep every ten seconds. The keypad beep may be silenced by performing a disarm command [PIN] + [OFF]. The warning message will continue to be displayed until the problem is repaired. Control Panel Warnings will not send a “System Trouble” report even if it is programmed.

Contact your installing company if the problems persist.

Error Messages:

- DS7447/DS7447E - “**AC Power Failure**” / DS7445/DS7445i - LED 1 turns on steady: There is a power failure and the panel is operating on backup battery.
- DS7447/DS7447E - “**Battery Trouble**” / DS7445/DS7445i - LED 2 turns on steady: If the system has just been through a power failure, wait at least two hours for the battery to recharge, then enter a [PIN] + [System Reset] to perform a battery test.
- DS7447/DS7447E - “**Communicator Err**” / DS7445/DS7445i - LED 3 turns on steady: The communicator failed to communicate with the central station.
- DS7447/DS7447E - “**System Fault**” / DS7445/DS7445i - LED 4 turns on steady: Internal error in the control circuitry or optional circuitry. These faults are designated as follows (see charts below):

- DS7447/DS7447E - “**Keypad Fault**” / DS7445/DS7445i - LED 5 turns on steady: One of the keypads is not responding to the control panel.
- DS7447/DS7447E - “**Keypad Tamper**” / DS7445/DS7445i - LED 6 turns on steady: One of the keypads is tampered.
- DS7447/DS7447E - “**Multiplex Bus**” / DS7445/DS7445i - LED 7 turns on steady: The multiplex bus is defective or has been shorted.
- DS7447/DS7447E - “**Aux Power Fault**” / DS7445/DS7445i - LED 8 turns on steady: The auxiliary power has been shorted.
- DS7447/DS7447E - “**Zone Trouble**”: One of the zones is not responding to the control panel. This may also be displayed during power-up (if so, ignore).

Warning Messages:

- DS7447/DS7447E - “**Dirty Chamber**”: One of the Multiplex smoke detectors has failed the sensitivity test and may require cleaning or replacement.

[#] [8] [7] will display	[#] [8] [9] will display
RAM Fault	System fault 01
ROM Fault	System fault 02
EEPROM Fault	System fault 03
Ground Fault	System fault 04
2Ph/Bell Fault = loss of communication to DS7420i	System fault 10
Line 1 Fault = DS7420i phone line 1 fault	System fault 11
Line 2 Fault = DS7420i phone line 2 fault	System fault 12
Bell Fault = DS7420i bell circuit fault	System fault 13
Aux. Relay Fault = DS7420i aux. relay fault	System fault 14
Oct. Relay Fault = loss of communication to DS7488	System fault 20
Reserved for older panels	System fault 50
AR IB Queue Full = modem buffer full	System fault 51
AR Host Down = network data switch down	System fault 52
AR Unreg. Modem = modem not registered	System fault 53
AR Power Fail = power source below defined threshold	System fault 54
AR Network Lost = loss of network	System fault 55
AR Modem HW Err = modem hardware error	System fault 56
AR Modem SW Err = modem software error	System fault 57
AR Opt. Bus Err = loss of communication to ARDIS module	System fault 58
AR Corrupt MSG = message error	System fault 59



If you want reports to be sent for these system faults, you must program Address 0334 to send System Trouble Reports.

Note: System Faults may be read from any keypad because they are system-wide.

All other Error Displays are limited to the partition the Standard keypad is in. If you are on a Master keypad, you may read Error Displays one partition at a time.

Action Desired	Command Sequence
Read Error display when green Power light is flashing.	[PIN] + [#] [8] [7]
Clear Error Display* <small>Caution: Clear the error display only on the advice of your installing company or if you are certain the problem has been remedied.</small>	[PIN] + [System Reset]

* = **Battery Trouble** display will only clear by the [System Reset] command or another automatic battery test even after the problem has been remedied. **Comm Error** display will only clear by the [System Reset] command or the next successful automatic system off normal report even after the problem has been remedied. All the other error displays will self clear from the keypads once the problem has been remedied.

8.0 Keypads

8.1 The Master Keypad

Your system may include a Master keypad.

A Master keypad is a DS7447/DS7447E keypad programmed to give a user access to all the partitions he has access to, not just the partition the Master keypad is in. This is different from a Standard keypad in that Standard keypads only give access to the single partition they are in. Commands entered at the Master keypad will affect all the partitions the user has access to. If this is not desirable, the Master keypad can be used to control partitions individually; this is called Single Partition Mode. Single Partition Mode allows a user to control the partitions he has access to on an individual (one by one) basis (see section 8.4 for more information on Single Partition Mode).

8.2 Master Keypad Displays

Master keypad displays will differ slightly from Standard keypads.

The Master keypad display will scroll the Status of each partition, followed by the partition number. For example, if all partitions are armed, the Master keypad will scroll through the following displays:

Armed Area 1 Armed Area 2 Armed Area 3 Armed Area 4 Armed Area 5 Armed Area 6 Armed Area 7 Armed Area 8

If only partitions 1, 2, 3, 4, 6, and 8 are armed, the Master keypad will scroll through the following displays:

Armed Area 1 Armed Area 2 Armed Area 3 Armed Area 4 Ready to Arm Area 5 Armed Area 6 Ready to Arm Area 7 Armed Area 8

Displays for partitions that are Not Ready will display in the same manner.

Light	Off	Flashing	On
Armed (red)	All partitions are disarmed.	One or more partitions are armed, or an alarm has occurred.	All partitions are armed, and no alarms have occurred.
Status (green)	Not ready to arm (if the Armed Light is on, all partitions are armed).	One or more zones are bypassed.	All partitions are ready to arm.
Power (green)	The control panel has lost all power; no AC or battery.	Control panel problems exist. See <i>Error Displays</i> .	Normal Operation. The control panel is running on AC power with no problems.
Fire (red)	There are no fire alarms.	A fire zone is in alarm.	A fire trouble condition exists.

8.3 Arming from the Master Keypad

Arming from the Master Keypad	
Arming all the Partitions you have access to.	Enter your PIN followed by one of the arming sequences. This will alarm all of your partitions, even if some are already armed.
Arming only some of your Partitions	You must enter Single Partition Mode to arm the necessary partitions one at a time. 1. Enter your [PIN], followed by the [#] key twice: [1] [2] [3] [4] [#] [#]. 2. The first partition you have access to will be displayed: " Ready to Arm. Cafeteria. " 3. Complete the arming command sequence you wish for this partition: [On]. 4. Move to the next partition you have access to by pressing the [#] key twice: [#] [#]. 5. The next partition you have access to will be displayed: " Ready to Arm. Office. " 6. Complete the arming command sequence you wish for this partition. 7. After you have completed all the arming command sequences for the partitions you have access to, exit Single Partition Mode by pressing the [*] key for 2 seconds.

8.4 Disarming from the Master Keypad

Disarming from the Master Keypad	
Disarming all the Partitions you have access to.	Enter your PIN followed by the [Off] key. This will disarm all of your partitions, even if some are already disarmed.
Disarming only some of your Partitions	You must enter Single Partition Mode to disarm the necessary partitions one at a time. 1. Enter your [PIN], followed by the [#] key twice: [1] [2] [3] [4] [#] [#]. 2. The first partition you have access to will be displayed: " Armed. Cafeteria. " 3. Complete the disarming command sequence for this partition: [Off]. 4. Move to the next partition you have access to by pressing the [#] key twice: [#] [#]. 5. The next partition you have access to will be displayed: " Armed. Office. " 6. Complete the disarming command sequence for this partition. 7. After you have disarmed all the partitions you have access to, exit Single Partition Mode by pressing the [*] key for 2 seconds.

8.5 Single Partition Mode

Single Partition Mode is used to control partitions on a "one at a time/one by one" basis from the Master keypad.

To enter the Single Partition Mode, enter your [PIN], then press the [#] key twice. This will call up the first partition you have access to. Enter the command sequence you wish for this partition. You do not need to use your PIN again. To move on to the next partition you have access to, press the [#] key twice.

To exit the Single Partition Mode, hold the [*] key down for 2 seconds. The system will automatically drop out of Single Partition Mode after 40 seconds without a keypad entry.

8.6 Volume and Backlight Controls

The keypad sounder and display backlight (on the DS7447/DS7447E) may be adjusted at the keypad.

- **Volume Control.** The keypad sounder volume can be adjusted using the [1] and [4] keys along with the [*] key.
 - Hold down the [*] key while pressing the [1] key to increase the volume or the [4] key to decrease the volume.
- **Backlight Control.** DS7447/DS7447E only. The backlight can be adjusted using the [3] and [6] keys along with the [*] key.
 - Hold down the [*] key while pressing the [3] key to increase the brightness or the [6] key to decrease the brightness.

NOTE After the backlight and volume are adjusted, you must arm and disarm the control panel once to store the information in the control panel. If power is disconnected before the panel is armed, the backlight and volume levels will return to the default settings.

9.0 How to Program the Control Panel

9.1 Entering the Programmer's Mode

To enter the Programmer's Mode, enter the Programmer's Code followed by [#] [0]. Shorting the program pads (see section 2.0 for location) on the control panel will also activate Programmer's Mode. The default Programmer's Code is [9] [8] [7] [6].

9.2 Reading back a Program Address

Once you are in the programmer's mode, to read back the value of a Program Address, enter that Program Address followed by [#]. Each data digit is displayed one data digit at a time. To view the second data digit, enter the # button again.

The display will look like this:

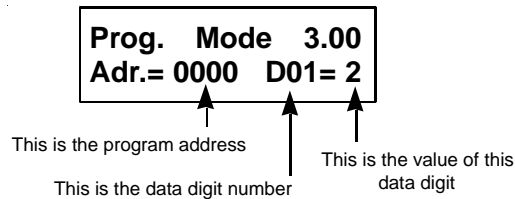

9.3 Entering a value in a Program Address

To enter a value in the Program Address, enter the Program Address, then enter the value for each Data Digit, then enter [#] to save it and move on to the next Program Address. Entering data digit 1 will increment you to the next data digit.

The display will show the Program Address and will display the value of each Data Digit after you enter it. The data will be programmed (saved) when you press the [#] key. The control panel will automatically increment to the next program address.

- If you wish to program that next address, enter the necessary information.
- If you wish to read back the value of that address, press the [#] key.
- If you wish to program a different address, press the [*] key two times and enter the program address you wish to program.

If you make a mistake at any time, press the [*] key two times (before pressing the [#] key). This will clear the display, allowing you to enter the program address you wish to work with.

9.4 HEX values

Some Data Digit values will be higher than 9. These values must be programmed by pressing the [*] key followed by some other number. These values will display as HEX characters (A - F) when entered. Example: entering *0 at the keypad will display an A.

The HEX character values are as follows:

*0 = A *1 = B *2 = C *3 = D *4 = E *5 = F

9.5 Defaults

The DS7400Xi is shipped from the factory as a working, pre-programmed control. Many of the programming addresses may already be set to the values you need. The default values are shown in **Reverse Print**

If the value you would like is in **Reverse Print**, you don't need to re-program this address.

In the example below, a "0" is the default value:

	0	1	2	3	4	5	6
Feature 1	●			●	●		●
Feature 2		●		●		●	●
Feature 3			●		●	●	●

If the default value is not shown in reverse print, it will be shown in a separate table.

9.6 Setting the Control to the Factory Default



Only enter [0] [1] [#] in Program Address 4058 when you are completely sure you want to erase all installer programming. Entering [0] [1] [#] in Program Address 4058 will immediately reset the control to the factory default. Any programming already done by the installer will be erased. This action cannot be reversed.

To set the control's programming values back to the default, enter the programming mode, then enter [4] [0] [5] [8] [0] [1] [#].

9.7 Exiting the Programmer's Mode

To exit the Programmer's Mode, press the [*] key for a minimum of 2 seconds. If no keypad entries are made for 4 minutes, the control will automatically exit you from the Programmer's Mode.

10.0 Understanding the Programming Charts

The Programming Reference Guide makes use of three types of charts. Each is described below. If the chart looks like this, a combination of features is available to be programmed for that particular address.

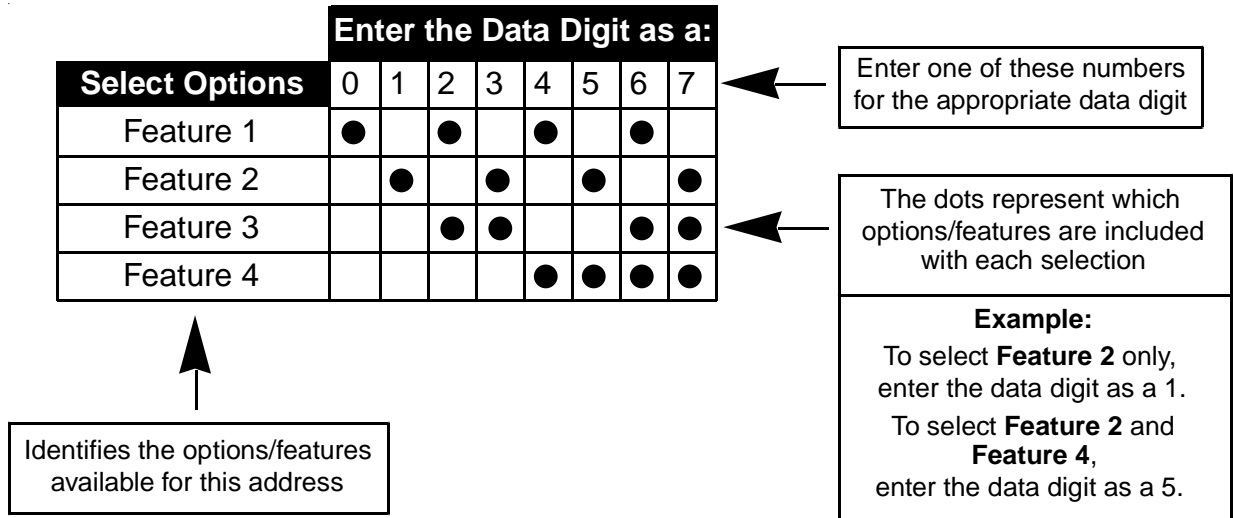

If the chart looks like this, only a single feature is available to be programmed for that particular address.

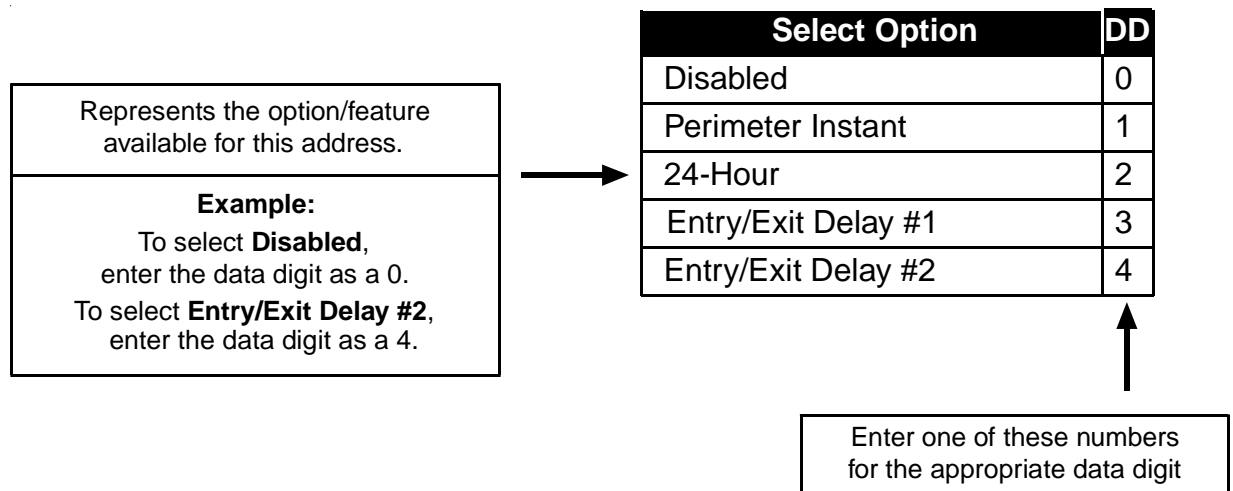

Some pages may also include a Default chart that looks like this:

Zone Function	Address	Default
1	0001	23
2	0002	24
3	0003	21

11.0 Programming

11.1 General Control Programming: Program Address (0000)

Example:

To program the system-wide General Operating parameters as: allowing Normal and Custom Arming, Operating at 60 Hz., and to Restore when a Zone Restores.

Data Digit 1 = [2], Data Digit 2 = [1].

Enter the Programmer's Mode: [9] [8] [7] [6] [#] [0]
 Enter the Program Address: [0] [0] [0] [0]
 Enter Data Digit 1: [2]
 Enter Data Digit 2: [1]
 Enter the pound key: [#]
 Program the next Address, Program a different Address, or Exit the Programmer's Mode.

General Control programming defines the system-wide general operating parameters.

See Glossary (section 6.1) for further details.

Select Options	Enter the Data Digit as a:																Data Digit	
	0	1	2	3	4	5	6	7	8	9	*0	*1	*2	*3	*4	*5	1	2
Allow Normal and Custom Arming**	●	●	●	●	●	●	●	●	●	●	●	●	●	●	●	●		
Allow Perimeter Instant Arming**	●	●			●	●			●	●			●	●				
Allow Perimeter Arming**	●	●			●	●			●	●			●	●				
Allow Maximum Security Arming**	●	●			●	●			●	●			●	●				
Closing Ring-Back					●	●	●	●					●	●	●	●		
Siren on Comm. Fail for Silent Zone									●	●	●	●	●	●	●	●		
50 Hz. operation Δ		●		●		●		●		●		●		●		●		
60 Hz. operation	●		●		●		●		●		●		●		●			

Δ = For installations in North America, select 60 Hz. operation.

*0 - *5 are Hex values. They will display as A - F at the keypads.

Select Options	Enter DD as a:								
	0	1	2	3	4	5	6	7	8
Restore zone when Sounders Silence	●			●			●		
Restore zone when Zone Restores		●			●			●	
Restore zone when System is Disarmed			●			●			●
Allow Swinger Shunts. Send Bypass Reports				●	●	●			
Allow Swinger Shunts. No Bypass Reports							●	●	●

- ** =
- Normal Arming = [PIN] + [On]: If programmed, Normal Arming arms the entire system while allowing entry delays for entry/exit zones.
 - Perimeter Instant Arming = [PIN] + [No Entry] + [Perimeter Only]: If programmed, Perimeter Instant Arming arms only the perimeter of the system and does not allow entry delays for entry/exit zones.
 - Perimeter Arming = [PIN] + [Perimeter Only]: If programmed, Perimeter Arming arms only the perimeter of the system while allowing entry delays for entry/exit zones.
 - Custom Arming = [PIN] + [#] [4]: If programmed, Custom Arming allows custom arming of the system and bypasses the zone functions specified in program address 0183.
 - Maximum Security Arming = [PIN] + [No Entry] + [On]: If programmed, Maximum Security Arming arms the entire system and does not allow entry delays for entry/exit zones.

Programming a Zone

Programming a Zone is a **three step process**. Step 1 is programming Zone Functions (what the zone will do in alarm), Step 2 is assigning a Zone Function to the zone and Step 3 is assigning the zone to a partition. These steps must be performed, **in order**, to program a zone.

Step 1: Programming the Zone Functions

11.2 Zone Function Programming: Program Addresses (0001-0015)

A Zone Function is the description of how a zone will behave. Up to 15 different Zone Functions may be programmed. You may use the default values (which are already programmed into the panel) and skip this step, change the defaults or add new Zone Functions.

See section 6.2 for further details.

Example:
To program Zone Function 1 as: Steady Alarm Output, Alarm on Short, Trouble on Open, Interior Instant.

Data Digit 1 = [6], Data Digit 2 = [7].

Enter the Programmer's Mode: [9] [8] [7] [6] [#] [0]
Enter the Program Address: [0] [0] [0] [1]
Enter Data Digit 1: [6]
Enter Data Digit 2: [7]
Enter the pound key: [#]
Program the next Address, Program a different Address, or Exit the Programmer's Mode.

** = Only when disarmed.
When armed, this becomes an Alarm on Open or Short for non 24-hour zones.
Note: Multiplex contacts (DS7450 and DS7452) should not be programmed for Trouble on Open.

Select Options	0	1	2	3	4	5	6	7	*2	*3	*4	*5
Invisible Alarm	●				●				●			
Silent Alarm		●				●				●		
Steady Alarm Output			●				●				●	
Pulsing Alarm Output				●				●				●
Alarm on Short	●	●	●	●	●	●	●	●				
Alarm on Open	●	●	●	●					●	●	●	●
Trouble on Open**					●	●	●	●				
Trouble on Short									●	●	●	●

*2 - *5 are Hex values. They will display as C - F at the keypads.

Value (fill in)	Zone Funct.	Address	Default Values (Will be forced to different values when in Commercial Fire Mode. See section 11.15.3)
	1	0001	2 = Steady alarm output, alarm on short and open. 3 = Entry/exit delay 1.
	2	0002	2 = Steady alarm output, alarm on short and open. 4 = Entry/exit delay 2.
	3	0003	2 = Steady alarm output, alarm on short and open. 1 = Perimeter Instant.
	4	0004	2 = Steady alarm output, alarm on short and open. 5 = Interior entry/exit follower.
	5	0005	2 = Steady alarm output, alarm on short and open. 6 = Interior home/away.
	6	0006	2 = Steady alarm output, alarm on short and open. 7 = Interior Instant.
	7	0007	2 = Steady alarm output, alarm on short and open. 2 = 24-hour.
	8	0008	7 = Pulsing alarm output, alarm on short, trouble on open. *0 = Fire zone with verification.
	9	0009	2 = Steady alarm output, alarm on short and open. 1 = Perimeter Instant.
	10	0010	2 = Steady alarm output, alarm on short and open. 1 = Perimeter Instant.
	11	0011	2 = Steady alarm output, alarm on short and open. 1 = Perimeter Instant.
	12	0012	2 = Steady alarm output, alarm on short and open. 1 = Perimeter Instant.
	13	0013	2 = Steady alarm output, alarm on short and open. 1 = Perimeter Instant.
	14	0014	2 = Steady alarm output, alarm on short and open. 1 = Perimeter Instant.
	15	0015	2 = Steady alarm output, alarm on short and open. 1 = Perimeter Instant.

Data Digit

1 2

□ □

Select Option	DD
Interior Delayed	0
Perimeter Instant	1
24-Hour	2
Entry/Exit Delay #1	3
Entry/Exit Delay #2	4
Interior Entry/Exit Follower	5
Interior Home/Away	6
Interior Instant	7
Day Monitor	8
Keyswitch (See note below)	9
Fire Zone with verification	*0
Fire Zone w/out verification	*1
Waterflow	*2
Supervisory	*3
Entry/Exit Delay Cancel 1	*4
Entry/Exit Delay Cancel 2	*5

□ 9

Note: If digit 2 = 9 (keyswitch), use this chart for digit 1.

Select Option	DD
Single Partition-No Force Arm	0
Single Partition-Can Force Arm	1
All Partitions-No Force Arm	2
All Partitions-Can Force Arm	3



Force Arming is **not** allowed on U.L. Listed systems.

Step 2: Assigning a Zone Function to the Zone

In this step, a Zone function is assigned to the Zone.

11.3 Zone Programming: Program Addresses (0018-0145)

In Zone Programming, each zone is defined according to its Input (single or multiple zone input, or a DS7465) and its Zone Function or Output function (1-15). The DS7465's relay is the only device that will follow the output functions; its input loop will follow a zone function. All single and multiple zone inputs will follow a zone function. See section 6.3 for further details.

Example:
To program a Zone (Zone 1) as a Single Zone Input (PIR) and follows Zone Function 1.

Data Digit 1 = [0], Data Digit 2 = [1].

Enter the Programmer's Mode: [9] [8] [7] [6] [#] [0]
Enter the Program Address: [0] [0] [1] [8]
Enter Data Digit 1: [0]
Enter Data Digit 2: [1]
Enter the pound key: [#]
Program the next Address, Program a different Address, or Exit the Programmer's Mode.

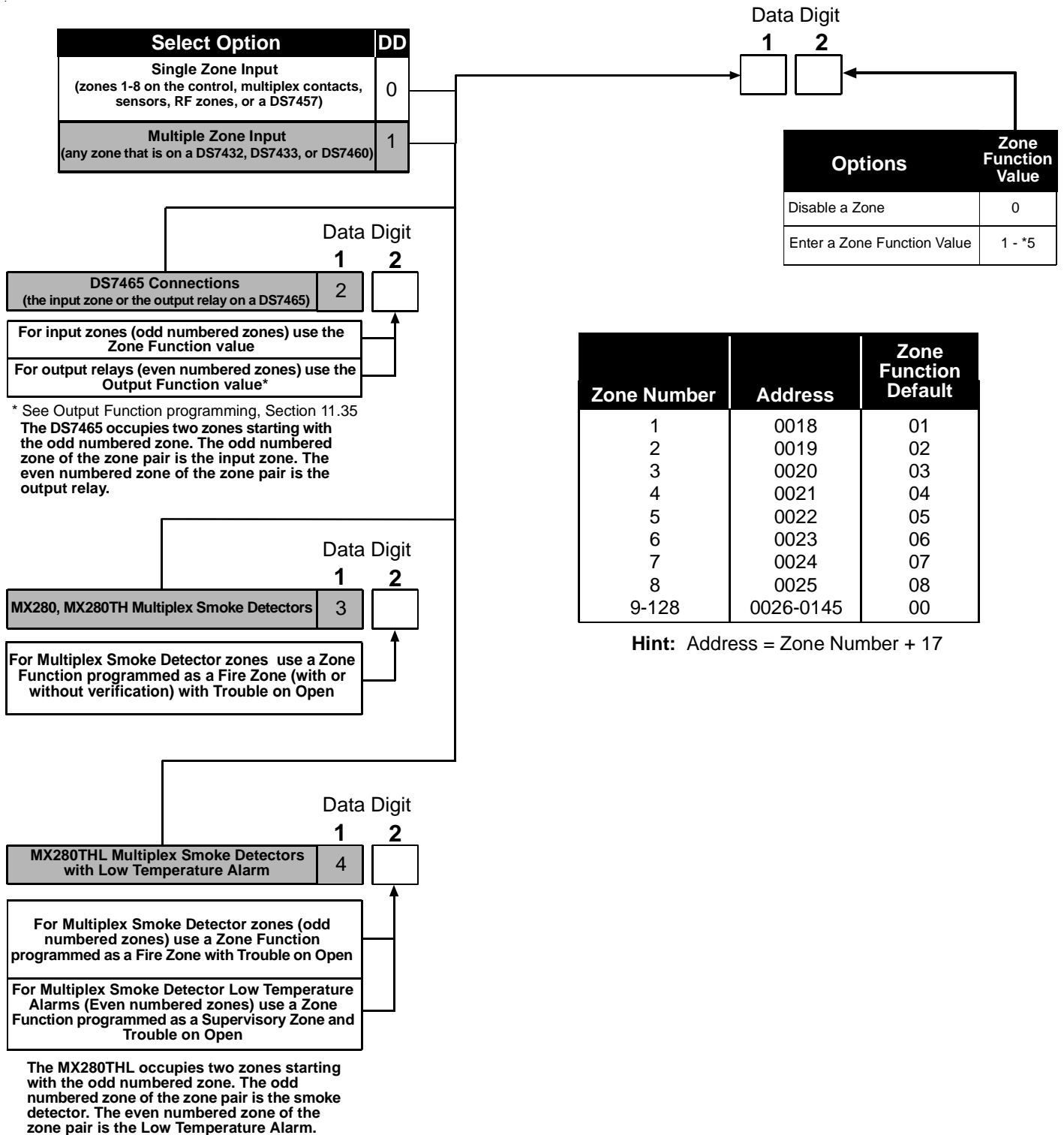

Step 3: Assigning a Partition to the Zone

11.4 Zone Partition Assignment: Program Addresses (1248-1311)

In Zone Partition Assignment, each zone is assigned to a partition. By default, all zones are assigned to partition 1.

The partition assignment for odd numbered zones is programmed in the first data digit of these addresses. The partition assignment for even numbered zones is programmed in the second data digit of these addresses.

For example, to assign zone 1 to partition 1 and zone 2 to partition 2, program address 1248 as 01.

Partition Assignment Address	
For Zones 1 and 2	1248
For Zones 3 and 4	1249
For Zones 5 and 6	1250
For Zones 7 and 8	1251
Zones 9 through 128	1252-1311

Select Option	DD
Belongs to Partition 1	0
Belongs to Partition 2	1
Belongs to Partition 3	2
Belongs to Partition 4	3
Belongs to Partition 5	4
Belongs to Partition 6	5
Belongs to Partition 7	6
Belongs to Partition 8	7

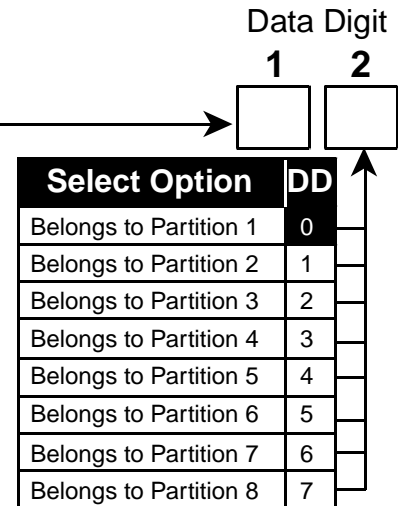

11.5 Zone Bypass Programming: Program Addresses (0016-0017)

Example:

To program zone functions 1 - 7 so they can not be bypassed and zone function 8 so it can be bypassed.

Data Digit 1 = [*] [5], Data Digit 2 = [7].

Enter the Programmer's Mode: [9] [8] [7] [6] [#] [0]

Enter the Program Address: [0] [0] [1] [6]

Enter Data Digit 1: [*] [5]

Enter Data Digit 2: [7]

Enter the pound key: [#]

Program the next Address, Program a different Address, or Exit the Programmer's Mode.

Zone Bypass programming determines which zone functions can be bypassed. Zone functions that can not be bypassed can not be force armed either. Fire zones can never be manually bypassed, but can be force armed. The Default of [0] or [8] means those zones can be bypassed.

PA 0016
Data Digit
1 2

	Enter the Data Digit as a:															
Select Options	0	1	2	3	4	5	6	7	8	9	*0	*1	*2	*3	*4	*5
Zone Function 1 Can Be Bypassed	●		●		●		●		●		●		●		●	
Zone Function 2 Can Be Bypassed	●	●			●	●			●	●			●	●		
Zone Function 3 Can Be Bypassed	●	●	●	●					●	●	●	●				
Zone Function 4 Can Be Bypassed	●	●	●	●	●	●	●	●								

*0 - *5 are Hex values. They will display as A - F at the keypads.

	Enter the Data Digit as a:															
Select Options	0	1	2	3	4	5	6	7	8	9	*0	*1	*2	*3	*4	*5
Zone Function 5 Can Be Bypassed	●		●		●		●		●		●		●		●	
Zone Function 6 Can Be Bypassed	●	●			●	●			●	●			●	●		
Zone Function 7 Can Be Bypassed	●	●	●	●					●	●	●	●				
Zone Function 8 Can Be Bypassed	●	●	●	●	●	●	●	●								

*0 - *5 are Hex values. They will display as A - F at the keypads.

PA 0017
Data Digit
1 2

	Enter the Data Digit as a:															
Select Options	0	1	2	3	4	5	6	7	8	9	*0	*1	*2	*3	*4	*5
Zone Function 9 Can Be Bypassed	●		●		●		●		●		●		●		●	
Zone Function 10 Can Be Bypassed	●	●			●	●			●	●			●	●		
Zone Function 11 Can Be Bypassed	●	●	●	●					●	●	●	●				
Zone Function 12 Can Be Bypassed	●	●	●	●	●	●	●	●								

*0 - *5 are Hex values. They will display as A - F at the keypads.

	Enter the Data Digit as a:															
Select Options	0	1	2	3	4	5	6	7	8	9	*0	*1	*2	*3	*4	*5
Zone Function 13 Can Be Bypassed	●		●		●		●		●		●		●		●	
Zone Function 14 Can Be Bypassed	●	●			●	●			●	●			●	●		
Zone Function 15 Can Be Bypassed	●	●	●	●					●	●	●	●				

*0 - *5 are Hex values. They will display as A - F at the keypads.

11.6 Output Programming: Program Addresses (0146-0148)

Example:

To program the Programmable Output 1 as: following a Burglar Zone Alarm that is in Partition 1.

PA 0147: Data Digit 1 = [6], Data Digit 2 = [1].

PA 0149: Data Digit 1 = [8], Data Digit 2 = [0].

Enter the Programmer's Mode: [9] [8] [7] [6] [#] [0]

Enter the Program Address: [0] [1] [4] [7]

Enter Data Digit 1: [6] Enter Data Digit 2: [1] Enter the pound key: [#]

Enter the Program Address: [0] [1] [4] [9]

Enter Data Digit 1: [8] Enter Data Digit 2: [0] Enter the pound key: [#]

Program the next Address, Program a different Address, or Exit the Programmer's Mode.

Output programming defines the event, partition, and type of alarm (burg or fire) that will trigger each of the three physical outputs on the control panel.

See section 3.0 for the location of the physical outputs on the control panel.

See Glossary (section 6.4) for further details.

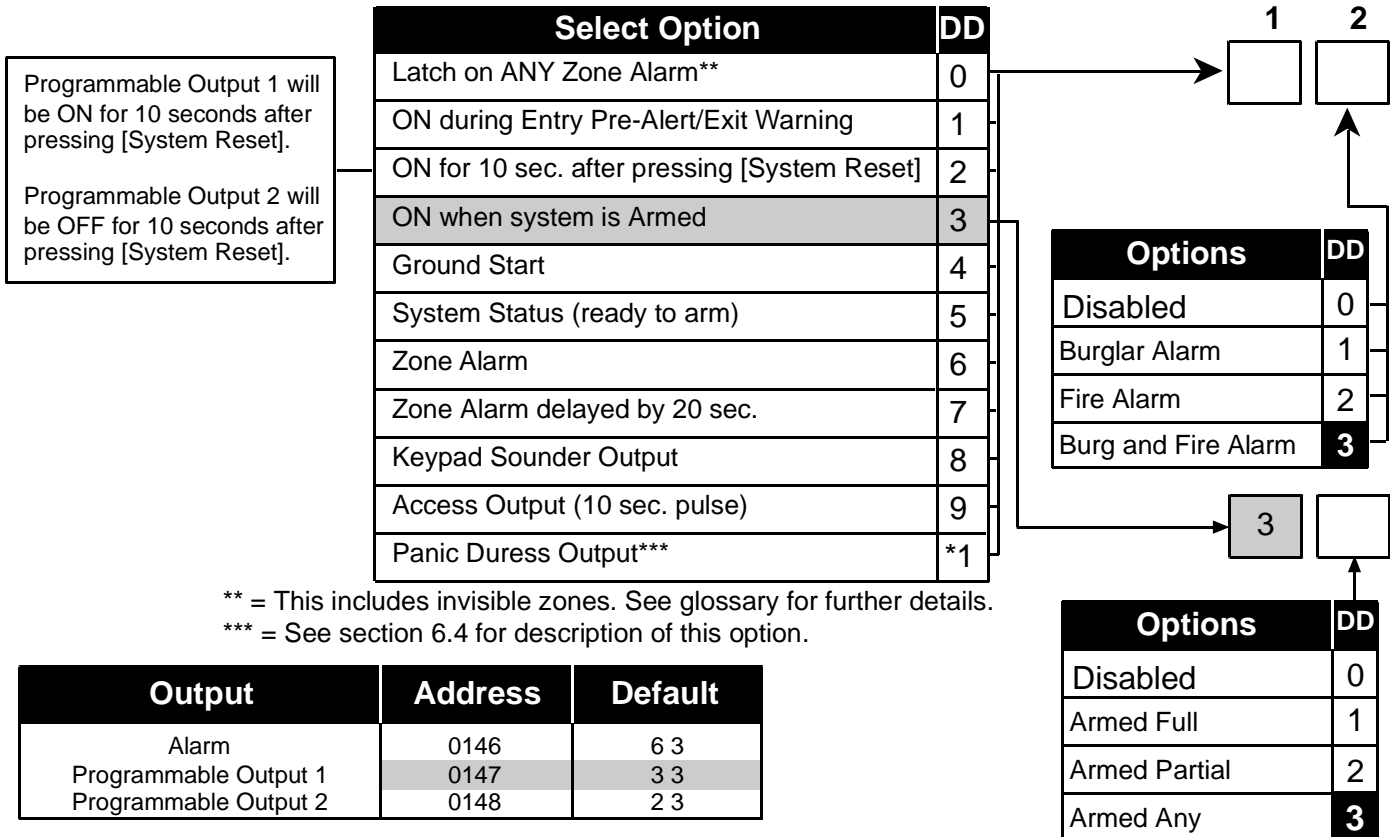

11.7 Output Partition Assignment: Program Addresses (0149-0150)

In Output Partition Assignment, each On-board output is assigned to a partition. By default, outputs are assigned to all partitions.

Output	Address	Default
Alarm	0149-DD1	8
Programmable Output 1	0149-DD2	8
Programmable Output 2	0150-DD1	8

Select Option	DD
Belongs to Partition 1	0
Belongs to Partition 2	1
Belongs to Partition 3	2
Belongs to Partition 4	3
Belongs to Partition 5	4
Belongs to Partition 6	5
Belongs to Partition 7	6
Belongs to Partition 8	7
Follows all Partitions	8

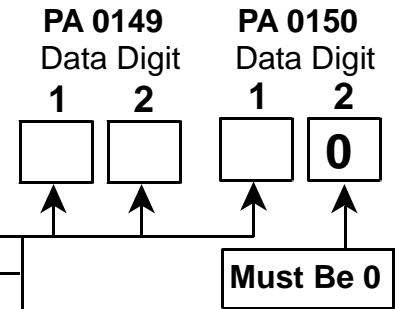

11.8 Partition Control Programming: Program Address (0165)

Example:

To program the Partition Control as: the System will use 3 Partitions, and Partition 1 is common to Partitions 2 and 3.

Data Digit 1 = [2], Data Digit 2 = [1].

Enter the Programmer's Mode: [9] [8] [7] [6] [#] [0]
 Enter the Program Address: [0] [1] [6] [5]
 Enter Data Digit 1: [2]
 Enter Data Digit 2: [1]
 Enter the pound key: [#]
 Program the next Address, Program a different Address, or Exit the Programmer's Mode.

Partition Control programming defines the number of partitions in use and the common area (common area can only be partition 1).

See Glossary (section 6.5) for further details.

Select Option	DD
Use 1 Partition	0
Use 2 Partitions	1
Use 3 Partitions	2
Use 4 Partitions	3
Use 5 Partitions	4
Use 6 Partitions	5
Use 7 Partitions	6
Use 8 Partitions	7

Select Option	DD
No Common Area	0
Partition 1 Common to Partition 2 and 3	1
Partition 1 Common to Partition 2 - 4	2
Partition 1 Common to Partition 2 - 5	3
Partition 1 Common to Partition 2 - 6	4
Partition 1 Common to Partition 2 - 7	5
Partition 1 Common to Partition 2 - 8	6

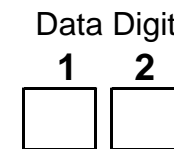

11.9 Quick Arm Control Programming: Program Address (0169)

Example:

To program so that Partitions 1 and 2 can be quick armed, while Partitions 3 through 8 can not be quick armed.

Data Digit 1 = [3], Data Digit 2 = [0].

Enter the Programmer's Mode: [9] [8] [7] [6] [#] [0]
 Enter the Program Address: [0] [1] [6] [9]
 Enter Data Digit 1: [3]
 Enter Data Digit 2: [0]
 Enter the pound key: [#]
 Program the next Address, Program a different Address, or Exit the Programmer's Mode.

Quick Arm Control programming defines which partitions can be quick armed (armed without requiring a PIN to be entered).

Data Digit

1 2

		Enter the Data Digit as a:															
Select Options		0	1	2	3	4	5	6	7	8	9	*0	*1	*2	*3	*4	*5
Partition 1 Quick Arm Enabled			●		●		●		●		●		●		●		●
Partition 2 Quick Arm Enabled				●	●			●	●			●	●			●	●
Partition 3 Quick Arm Enabled						●	●	●	●					●	●	●	●
Partition 4 Quick Arm Enabled										●	●	●	●	●	●	●	●

		Enter the Data Digit as a:															
Select Options		0	1	2	3	4	5	6	7	8	9	*0	*1	*2	*3	*4	*5
Partition 5 Quick Arm Enabled			●			●		●		●		●		●		●	●
Partition 6 Quick Arm Enabled				●	●			●	●			●	●			●	●
Partition 7 Quick Arm Enabled						●	●	●	●					●	●	●	●
Partition 8 Quick Arm Enabled										●	●	●	●	●	●	●	●

11.10 Keypad Assignment Programming: Program Addresses (0173-0180)

Example:

To program Keypad 1 as an Alpha Keypad that is assigned to Partition 1.

PA 0173: Data Digit 1 = [1], Data Digit 2 = [0].

PA 0208: Data Digit 1 = [2], Data Digit 2 = [0].

Enter the Programmer's Mode: [9] [8] [7] [6] [#] [0]

Enter the Program Address: [0] [1] [7] [3] (Data Digit 1)

Enter Data Digit 1: [1] Enter Data Digit 2: [0] Enter the pound key: [#]

Enter the Program Address: [0] [2] [0] [8]

Enter Data Digit 1: [0] Enter Data Digit 2: [0] Enter the pound key: [#]

Program the next Address, Program a different Address, or Exit the Programmer's Mode.

Keypad Assignment Programming is where you assign the keypad type and the partition it belongs to.

See Glossary (section 6.6) for further details.

NOTE Each keypad must have its own Bus address. This must also be selected on the keypad via its address pins. See In Guide P/N 25902. One keypad must be selected as keypad 1.

Defaults: The default, if using only one keypad, is an Alpha keypad belonging to partition one.

Program Address 0173

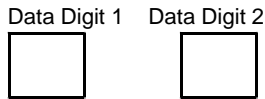

Keypad 1*
default = 1

Keypad 2
default = 0

Program Address 0174

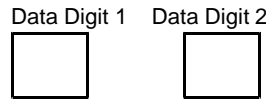

Keypad 3
default = 0

Keypad 4
default = 0

Program Address 0175

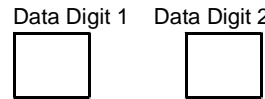

Keypad 5
default = 0

Keypad 6
default = 0

Program Address 0176

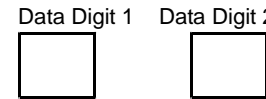

Keypad 7
default = 0

Keypad 8
default = 0

Program Address 0177



Keypad 9
default = 0

Keypad 10
default = 0

Program Address 0178

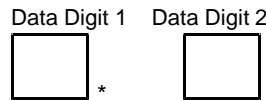

Keypad 11**
default = 0

Keypad 12**
default = 0

Program Address 0179

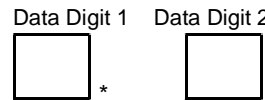

Keypad 13**
default = 0

Keypad 14**
default = 0

Program Address 0180

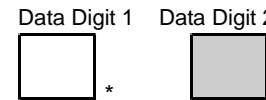

Keypad 15**
default = 0

* = When in Commercial Fire Mode, certain keypads must have specific assignments (see section 6.11).

** = Keypads 11-15 are connected to the Option Bus. If the DS7412 is connected to the Option Bus (at keypad address 13 or 14), keypad 13 or 14 is unavailable. Similarly, if the DS7420i is connected to the Option Bus at keypad address 15, keypad 15 is unavailable; and if the DS7488 is connected to the Option Bus at keypad address 11-15, the corresponding keypad(s) is (are) unavailable.

Select Options	0	1	2	3
Disabled	●			
Alpha (LCD) Keypad		●		●
LED Keypad			●	
Master Keypad***				●

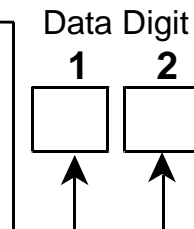

Select Options	0	1
LCD Backlight Always On	●	
LCD Backlight Off Until Keypress		●

Backlight selection affects all LCD keypads

*** = If only using one partition, do not program keypads as Master Keypads.

Only program for a Master Keypad if you need to view multiple partitions from a single keypad.

11.11 Keypad Partition Assignment: Program Addresses (0208-0215)

Program Address 0208



Keypad 1

Keypad 2

Program Address 0209



Keypad 3

Keypad 4

Program Address 0210



Keypad 5

Keypad 6

Program Address 0211

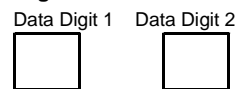

Keypad 7

Keypad 8

Program Address 0212



Keypad 9

Keypad 10

Program Address 0213



Keypad 11

Keypad 12

Program Address 0214

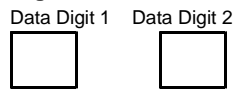

Keypad 13

Keypad 14

Program Address 0215

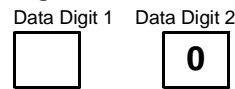

Keypad 15

Must Be 0

Select Option	DD
Belongs to Partition 1	0
Belongs to Partition 2	1
Belongs to Partition 3	2
Belongs to Partition 4	3
Belongs to Partition 5	4
Belongs to Partition 6	5
Belongs to Partition 7	6
Belongs to Partition 8	7

11.12 Emergency Key Programming: Program Addresses (0181-0182)

Example:

To program the Fire Key and the Special Emergency Key as both having a Steady Alarm.

Data Digit 1 = [2], Data Digit 2 = [2].

Enter the Programmer's Mode: [9] [8] [7] [6] [#] [0]
 Enter the Program Address: [0] [1] [8] [1]
 Enter Data Digit 1: [2]
 Enter Data Digit 2: [2]
 Enter the pound key: [#]
 Program the next Address, Program a different Address, or Exit the Programmer's Mode.

Emergency Key and Panic Key programming disables or activates these keys (the A, B, and C keys) located on the keypads. It also determines a silent, pulsed, or steady alarm.

See Glossary (section 6.7) for further details.

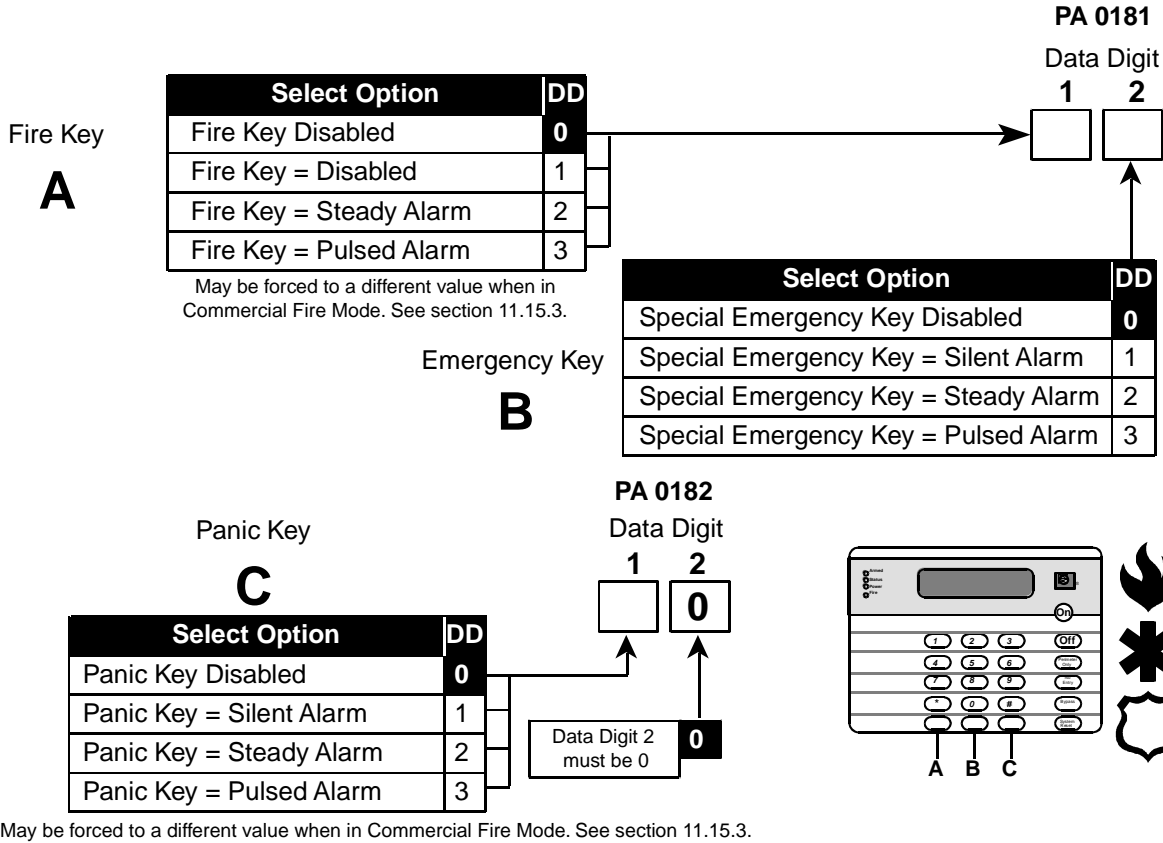

11.13 Custom Arming Programming: Program Addresses (0183-0184)

Example:

To program the [4] to Bypass Zone Function 1 only.

Data Digit 1 = [1], Data Digit 2 = [0].

Enter the Programmer's Mode: [9] [8] [7] [6] [#] [0]
 Enter the Program Address: [0] [1] [8] [3]
 Enter Data Digit 1: [1]
 Enter Data Digit 2: [0]
 Enter the pound key: [#]
 Program the next Address, Program a different Address, or Exit the Programmer's Mode.

Select Options	Enter the Data Digit as a:															
	0	1	2	3	4	5	6	7	8	9	*0	*1	*2	*3	*4	*5
Bypass Zone Function 1		●		●		●		●		●		●		●		●
Bypass Zone Function 2			●	●			●	●			●	●			●	●
Bypass Zone Function 3					●	●	●	●					●	●	●	●
Bypass Zone Function 4									●	●	●	●	●	●	●	●

*0 - *5 are Hex values. They will display as A - F at the keypads.

Select Options	Enter the Data Digit as a:															
	0	1	2	3	4	5	6	7	8	9	*0	*1	*2	*3	*4	*5
Bypass Zone Function 5		●		●		●		●		●		●		●		●
Bypass Zone Function 6			●	●			●	●			●	●			●	●
Bypass Zone Function 7					●	●	●	●					●	●	●	●
Bypass Zone Function 8									●	●	●	●	●	●	●	●

*0 - *5 are Hex values. They will display as A - F at the keypads.

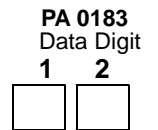

11.13 Custom Arming Programming: Program Addresses (0183-0184) (Continued)

PA 0184
Data Digit
1 2

		Enter the Data Digit as a:														
Select Options	0	1	2	3	4	5	6	7	8	9	*0	*1	*2	*3	*4	*5
Bypass Zone Function 9		●		●		●		●		●		●		●		●
Bypass Zone Function 10			●	●			●	●			●	●			●	●
Bypass Zone Function 11					●	●	●	●					●	●	●	●
Bypass Zone Function 12									●	●	●	●	●	●	●	●

*0 - *5 are Hex values. They will display as A - F at the keypads.

		Enter the Data Digit as a:							
Select Options	0	1	2	3	4	5	6	7	
Bypass Zone Function 13		●		●		●		●	
Bypass Zone Function 14			●	●			●	●	
Bypass Zone Function 15					●	●	●	●	

11.14 Force Arming and Ground Fault Detect Programming: Program Address (0185)

Example:

To be able to Force Arm up to 5 Zones and have Ground Fault Off.

Data Digit 1 = [5], Data Digit 2 = [0].

Enter the Programmer's Mode:
[9] [8] [7] [6] [#] [0]

Enter the Program Address: [0] [1] [8] [5]
Enter Data Digit 1: [5]
Enter Data Digit 2: [0]
Enter the pound key: [#]

Program the next Address, Program a different Address, or Exit the Programmer's Mode.

Force Arming programming defines how many zones may be Force Armed using an Arming sequence followed by the [Bypass] key. With this entry, all violated zones (up the programmed limit) will automatically be Force Armed (bypassed). Ground Fault Detect programming determines whether or not the control will detect a ground fault condition.

See Glossary (section 6.9) for further details.

Select Option	DD
Do not allow Force Arming	0
Allow up to 1 zone to be Force Armed	1
Allow up to 2 zones to be Force Armed	2
Allow up to 3 zones to be Force Armed	3
Allow up to 4 zones to be Force Armed	4
Allow up to 5 zones to be Force Armed	5
Allow up to 6 zones to be Force Armed	6
Allow up to 7 zones to be Force Armed	7
Allow up to 8 zones to be Force Armed	8
Allow up to 9 zones to be Force Armed	9

Data Digit
1 2



Force Arming is **not** allowed on U.L. Listed systems.

Select Option	DD
Ground Fault Detect Off	0
Ground Fault Detect On	1

11.15 Commercial Fire Mode Programming: Program Address (0186)

Example:

To program the Commercial Fire Mode parameters as: Central Station Commercial Fire Mode enabled, with a 10 second delay on Waterflow Zones, having the Bell and Aux. activate on Fire Alarms, and using California March Time.

Data Digit 1 = [8], Data Digit 2 = [1].

Enter the Programmer's Mode: [9] [8] [7] [6] [#] [0]
 Enter the Program Address: [0] [1] [8] [6]
 Enter Data Digit 1: [8]
 Enter Data Digit 2: [1]
 Enter the pound key: [#]
 Program the next Address, Program a different Address, or Exit the Programmer's Mode.

This section describes how to define the parameters for the Commercial Fire Mode.

See Glossary (section 6.11) for further details.

Select Options	Enter the Data Digit as a:												Data Digit				
	0	1	2	3	4	5	6	7	8	9	*0	*1	*2	1	2		
Commercial Fire Mode disabled	●																
Local Comm. Fire Mode enabled		●	●	●	●	●	●										
Central Station Comm. Fire Mode enabled									●	●	●	●	●	●			
10 sec. delay on waterflow zone			●							●							
20 sec. delay on waterflow zone				●							●						
30 sec. delay on waterflow zone					●							●					
40 sec. delay on waterflow zone						●							●				
50 sec. delay on waterflow zone							●							●			

*0 - *2 are Hex values. They will display as A - C at the keypads.

Zones 1-4 may only have waterflow delays.

Select Options	Enter the DD as a:					
	0	1	2	3	4	5
Bell and Aux. activate on Fire	●	●	●	●	●	●
Bell and Aux. activate on Burg				●	●	●
Pulsing Fire Alarms are 1 sec. On / 1 sec. Off	●			●		
Pulsing Fire Alarms use California March Time		●			●	
Pulsing Fire Alarms use Temporal Cadence			●			●

When programming Fire zones, it is recommended that they be zone functions 12 and 13 (see sections 11.1 and 11.15.3).
11.15.1 When Central Station Commercial Fire Mode is chosen, address 1520 (DS7420i: Dual Phone Line/Bell Supervision Module Output Programming), will be forced to a value of 5.

11.15.2 When Local Commercial Fire Mode is chosen, address 1520 (DS7420i: Dual Phone Line/Bell Supervision Module Output Programming), will be forced to a value of 3, 4, or 5. (Turns the Bell Monitor feature ON and the Alarm Output on Line Fault feature OFF)

11.15.3 Regardless of which Commercial Fire Mode is chosen, the following parameters will be forced when exiting local programmer's mode:

- Zone Function 12, address 0012, will be a 7 *0.
- Zone Function 13, address 0013, will be a 7 *1.
- Zone Function 14, address 0014, will be a 7 *2.
- Zone Function 15, address 0015, will be a 7 *3.
- Zone Bypass address 0017 will not allow zone functions 12 - 15 to be bypassed.
- Emergency Key, address 0181, data digit 1, will become a 3 if programmed previously as a 2. Data digit 2 will become a 2 if programmed previously as a 3.
- Panic Key, address 0182, data digit 1, will become a 2 if programmed previously as a 3.
- Fire Bell Cutoff, address 0195: If less than 5, set to 5, otherwise untouched.
- The AC Fail Report delay will be random between 6-12 hours regardless of the delay time programmed in 0147. Also, the AC Fail Report will not be sent as a "tag-along."

11.15.4 In Central Station Commercial Fire Mode, the following communication parameters will be forced:

Report Codes: If 0, the following defaults will be set, otherwise they will be unchanged.

Address	Default	Address	Default	Address	Default	Address	Default	Address	Default
0256	*0 1	0272	*0 6	0325	6 9	0326	7 9	0331	6 *5
0257	7 1	0286	7 3	0301	6 3	0327	6 *0	0334	3 9
0269	*0 3	0287	7 4	0302	6 4	0328	7 *0	0335	3 *0
0270	*0 4	0288	7 5	0303	6 5	0329	8 3	0336	3 9
0271	*0 5	0289	7 6	0304	6 6	0330	7 *5		

- Phone Control: If 0, set to 6 1, 4/2 @ 18/23, 10pps, otherwise untouched.
- Test Report: Set to 8, call out every day.

11.16 Open/Close Report Control Programming: Program Address (0187)

Example:
 To program to send Open/Close Reports from Partition 1 and to send Trouble Reports on Closings for all Bypassed Zones.

Data Digit 1 = [1], Data Digit 2 = [1].

Enter the Programmer's Mode: [9] [8] [7] [6] [#] [0]
 Enter the Program Address: [0] [1] [8] [7]
 Enter Data Digit 1: [1]
 Enter Data Digit 2: [1]
 Enter the pound key: [#]
 Program the next Address, Program a different Address, or Exit the Programmer's Mode.

If programmed, these reports are sent when the system is armed or disarmed. They may be sent independently for the opening and closing of each partition, or the first partition to open and the last partition to close may send the reports.
See Glossary (section 6.12) for further details.

Select Options	Enter the Data Digit as a:									
	0	1	2	3	4	5	6	7	8	9
Do not report opens or closes	●									
Report opens and closes in Partition 1		●	●	●	●	●	●	●		
Report opens and closes in Partition 2			●	●	●	●	●	●		
Report opens and closes in Partition 3				●	●	●	●	●		
Report opens and closes in Partition 4					●	●	●	●		
Report opens and closes in Partition 5						●	●	●		
Report opens and closes in Partition 6							●	●		
Report opens and closes in Partition 7								●	●	
Report opens and closes in Partition 8									●	
Report first Partition to open and last Partition to close**										●

Send Closing and Bypass reports at close: **0**

Send Closing and Bypass reports after exit delay: **1**

Data Digit 1: [] Data Digit 2: [0]

** = When using this option, all partitions should have the same account code.

11.17 Open/Close & Zone Report Control Programming: Program Address (0189)

This section allows you to decide which phone number will send open and close reports, zone alarm, zone restoral, and zone trouble reports.

Example:
 To program to send Open and Close Reports to Phone Number 1 and Zone Alarm, Zone Restoral, and Zone Trouble Reports to Phone Number 2.

Data Digit 1 = [1], Data Digit 2 = [2].

Enter the Programmer's Mode: [9] [8] [7] [6] [#] [0]
 Enter the Program Address: [0] [1] [8] [9]
 Enter Data Digit 1: [1]
 Enter Data Digit 2: [2]
 Enter the pound key: [#]
 Program the next Address, Program a different Address, or Exit the Programmer's Mode.

Select Option	DD
Alternate between both Phone Numbers	0
Report to Phone Number 1	1
Report to Phone Number 2	2
Report to Phone Number 1 and 2	3

Select Option	DD
Alternate between both Phone Numbers	0
Report to Phone Number 1	1
Report to Phone Number 2	2
Report to Phone Number 1 and 2	3

Data Digit 1 is for Open and Close Reports.

Data Digit 2 is for Zone Alarm, Zone Restoral, Zone Trouble, Bypass, Unbypass, and Trouble Restoral Reports

11.18 Report Control Programming: Program Address (0190)

This section allows you to decide which phone number will send reports other than open/close reports and zone reports.

Example:
 To program all other Reports to Phone Number 2.

Data Digit 1 = [2], Data Digit 2 = [0].

Enter the Programmer's Mode: [9] [8] [7] [6] [#] [0]
 Enter the Program Address: [0] [1] [9] [0]
 Enter Data Digit 1: [2]
 Enter Data Digit 2: [0]
 Enter the pound key: [#]
 Program the next Address, Program a different Address, or Exit the Programmer's Mode.

Select Option	DD
Alternate between both Phone Numbers	0
Report to Phone Number 1	1
Report to Phone Number 2	2
Report to Phone Number 1 and 2	3

Data Digit 1: [] Data Digit 2: [0]

Note: Data Digit 1 does not include open and close reports or zone reports (see sections 11.16 and 11.17).

Data Digit 2 must be 0

11.19 Timer Programming: Program Addresses (0191-0193, 0195-0196)

Example:

To program the Entry Delay Time 1 for 60 seconds.

Data Digit 1 = [1], Data Digit 2 = [2].

Enter the Programmer's Mode: [9] [8] [7] [6] [#] [0]

Enter the Program Address: [0] [1] [9] [1]

Enter Data Digit 1: [1]

Enter Data Digit 2: [2]

Enter the pound key: [#]

Program the next Address, Program a different Address, or Exit the Programmer's Mode.

Entry and Exit Delay Timers are in 5 second intervals (the maximum delay time is 255 seconds).

For example:

5 sec. = 01

15 sec. = 03

20 sec. = 04

30 sec. = 06

45 sec. = 09

60 sec. = 12

255 sec. = 51

Data Digit

1

2

--	--

Exit Delay Time

Address 0193

0 to 51 (0 to 255 sec.*)

Default = 12 (60 sec.)

*5 second intervals

Data Digit

1

2

--	--

Entry Delay Time 1

Address 0191

0 to 51 (0 to 255 sec.*)

Default = 09 (45 sec.)

*5 second intervals

May be forced to a different value when in Commercial Fire Mode. See section 11.17.3.

Data Digit

1

2

--	--

Fire Bell Cutoff

Address 0195

0 to 98 minutes**

Default = 04 minutes

**1 minute intervals

Entering a value of 99 will give a bell cutoff time of 30 seconds.

Data Digit

1

2

--	--

Entry Delay Time 2

Address 0192

0 to 51 (0 to 255 sec.*)

Default = 09 (45 sec.)

*5 second intervals

Data Digit

1

2

--	--

Burglary Bell Cutoff

Address 0196

0 to 98 minutes**

Default = 04 minutes

**1 minute intervals

11.20 AC Fail Report Delay Programming: Program Address (0197)

Example:

To program the AC Fail Report Delay Time to be 30 minutes.

Data Digit 1 = [1], Data Digit 2 = [*] [4].

Enter the Programmer's Mode: [9] [8] [7] [6] [#] [0]

Enter the Program Address: [0] [1] [9] [7]

Enter Data Digit 1: [1]

Enter Data Digit 2: [*] [4]

Enter the pound key: [#]

Program the next Address, Program a different Address, or Exit the Programmer's Mode.

The AC Fail Delay Times are programmed as Hexadecimal values. For example:

00 = Send only with next report

1 *4 = 30 minute delay

3 *2 = 60 minute delay

78 = 120 minute delay

*5 0 = 240 minute delay

*5 *5 = Random delay (at least 15 minutes, but less than 120 minutes)

(*0 - *5 are Hex values. They will display as A through F at the keypads.)

See Glossary (section 6.13) for further details.

Data Digit

1

2

--	--

AC Fail Report Delay

Address 0197

00 through FF

Default = 00



If the DS7400Xi Version 3+ is configured as a Commercial Fire Mode System (Address 0186 - section 1-*2) the AC Failure Report is sent on a random basis at any time between 6 and 12 hours after the failure of the AC Primary power when any other report is sent to the Central Station. This delay is to comply with NFPA-72 Section 1-5.8.7.3 which requires that the battery achieve a discharge of between 25% and 50% before the AC Failure Report is sent. The delay time set into Address 0197 has no effect when the DS7400Xi is in the Commercial Fire Mode.

11.21 General Code “Arm Only” Programming: Program Address (0198-0201)

This allows for a user with a General Authority level to Arm and Bypass zones he is not able to Disarm.

Example:

To program a General Authority level to be able to Arm and Bypass zones he is not able to Disarm in Partition 1.

Data Digit 1 = [1], Data Digit 2 = [0].

Enter the Programmer's Mode: [9] [8] [7] [6] [#] [0]
 Enter the Program Address: [0] [1] [9] [8] (Data Digit 1)
 Enter Data Digit 1: [1]
 Enter Data Digit 2: [0]
 Enter the pound key: [#]
 Program the next Address, Program a different Address, or Exit the Programmer's Mode.

See Glossary (section 6.1) for further details.

Select Option	DD
General Code can Arm, Disarm, and Bypass	0
General Code can Arm and Bypass	1
General Code can Arm and Disarm	2
General Code can Arm	3

Program Address 0198

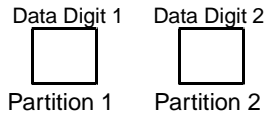

Program Address 0200

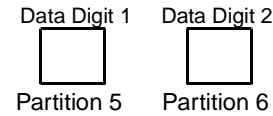

Program Address 0199

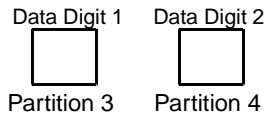

Program Address 0201

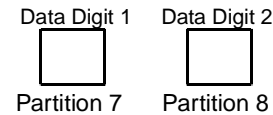

11.22 Arming Warning Programming: Program Addresses (0202-0205)

Example:

To program the keypads in Partition 1 to be audible during exit delay and the keypads in Partition 2 not to be audible during exit delay.

Data Digit 1 = [4], Data Digit 2 = [0].

Enter the Programmer's Mode: [9] [8] [7] [6] [#] [0]
 Enter the Program Address: [0] [2] [0] [2]
 Enter Data Digit 1: [4]
 Enter Data Digit 2: [0]
 Enter the pound key: [#]
 Program the next Address, Program a different Address, or Exit the Programmer's Mode.

Arming Warning programming defines whether the keypad will be audible during the exit delay and auto arm period. If programmed, the keypad sounder will activate once every 5 seconds during the exit delay. At 10 seconds and 5 seconds remaining, the keypad sounder will activate 3 times. During auto arming, a pre-arming period will begin 15 minutes before the system arms automatically. The keypad sounders will pulse five times every minute. During the last five minutes before arming, these sounders will be on steady.

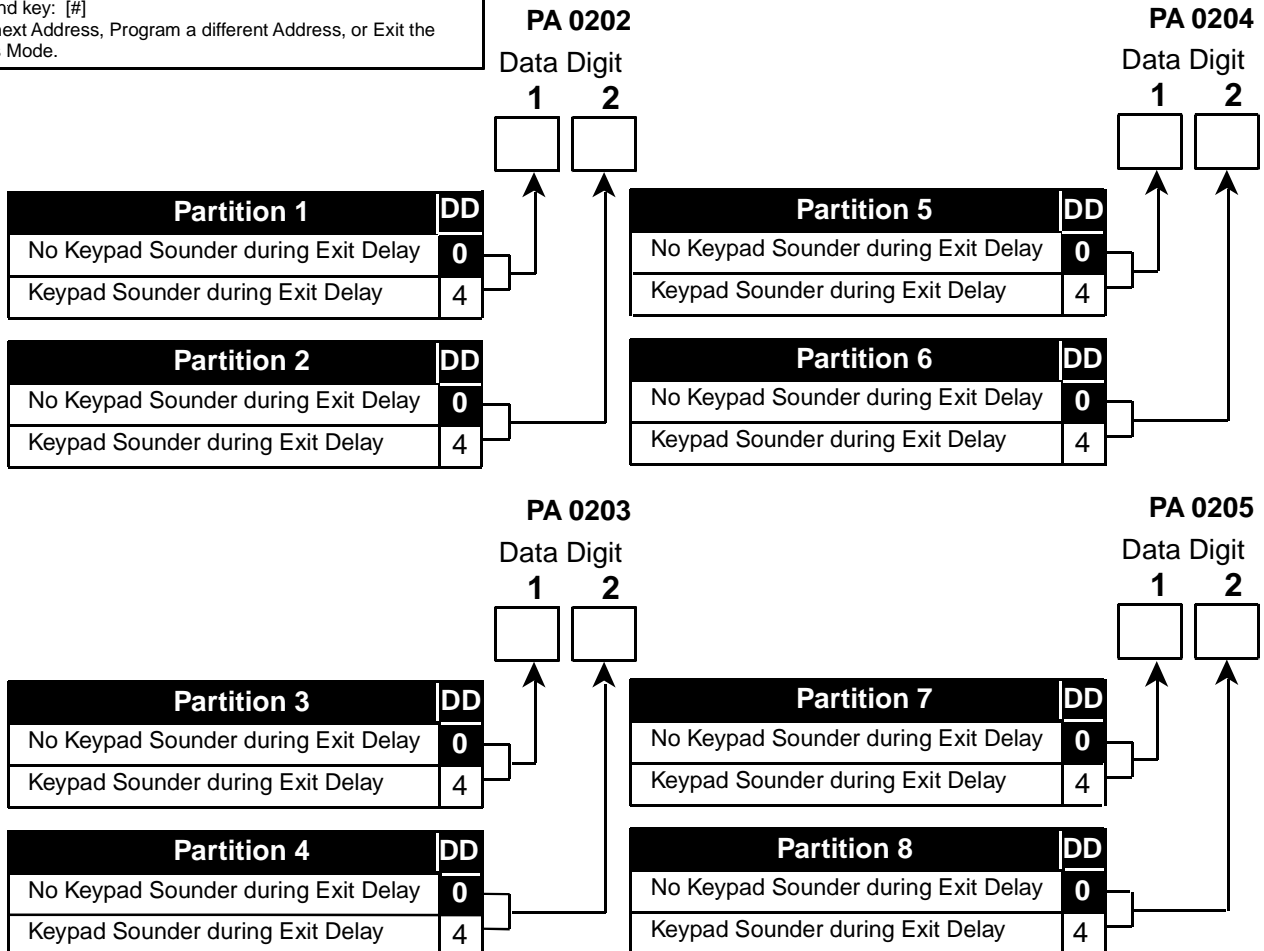

11.23 DS7412 RS232 Interface Control Programming: Program Address (0206)

Example:

To program to enable the DS7412 and send Open/Close Reports to the printer.

Data Digit 1 = [1], Data Digit 2 = [2].

Enter the Programmer's Mode: [9] [8] [7] [6] [#] [0]
 Enter the Program Address: [0] [2] [0] [6]
 Enter Data Digit 1: [1]
 Enter Data Digit 2: [2]
 Enter the pound key: [#]
 Program the next Address, Program a different Address, or Exit the Programmer's Mode.

DS7412 RS232 Interface Control Programming allows you to enable or disable the DS7412 and to select which history events are sent to the printer as they occur. Selecting "No Events" will cause the history to be printed only on command.

To print the History Buffer starting from the most recent event, enter the Master Code followed by [#] [0] [8]. To stop printing, enter Master Code [#] [0] [8] again.

NOTE If using the WDSRP Direct Connection option for programming, Address 0206 must be set for 1 0. Address 0207 must be set for 2 5.

Select Option	DD
DS7412 Disabled	0
DS7412 Enabled	1

Select Options	Enter the Data Digit as a:							
	0	1	2	3	4	5	6	7
No Events	●							
Alarms, Troubles, and Restorals		●		●		●		●
Opens and Closes			●	●			●	●
All Other Events					●	●	●	●

11.24 DS7412 RS232 Interface Configuration Programming: Program Address (0207)

Example:

To program a 1200 Baud printer for No Parity, Software Flow Control, 2 Stop Bits and 8 Data Bits.

Data Digit 1 = [1], Data Digit 2 = [2].

Enter the Programmer's Mode: [9] [8] [7] [6] [#] [0]
 Enter the Program Address: [0] [2] [0] [7]
 Enter Data Digit 1: [1]
 Enter Data Digit 2: [2]
 Enter the pound key: [#]

Program the next Address, Program a different Address, or Exit the Programmer's Mode.

DS7412 RS232 Interface Configuration Programming allows you to configure the DS7412 for your printer. Most printers will operate using the default values for the DS7412. Some printers may operate more efficiently using optional program values.

Consult the operating guide provided with your printer to be sure that its configuration matches the one programmed here.

NOTE If using the WDSRP Direct Connection option for programming, Address 0206 must be set for 1 0. Address 0207 must be set for 2 5.

Select Option	DD
300 Baud	0
1200 Baud	1
2400 Baud	2
4800 Baud	3
9600 Baud	4
14400 Baud	5

Select Options	Enter the Data Digit as a:							
	0	1	2	3	4	5	6	7
No Parity	●	●	●	●				
ODD Parity					●	●		
EVEN Parity							●	●
Software Flow Control	●		●		●		●	
Hardware Flow Control		●		●		●		●
1 Stop Bit	●	●			●	●	●	●
2 Stop Bits			●	●				
8 Data Bits	●	●	●	●	●	●	●	●

11.25 Report Programming: Program Addresses (0256-0304 and 0320-0340)

- To send RF zone trouble reports, the System Trouble Report, address 0334 must be programmed.
- To send the User number along with open, close, or partial close reports, place an 'F' (*5) in the extended digit.
- To disable a report (meaning: nothing will be sent): place a '0' (zero) in the reporting digit.
- When using SIA, place a '1' in the reporting digit and program the extended digit to use the extended SIA codes. For Contact ID format, place a '1' in the reporting digit of each report you wish to enable. It is not necessary to program the extended digit.
- For suggested values for 4/2, BFSK and Pager format, see section 13.1-13.3. For SIA and Contact ID, the values sent are listed in section 14.1. For other formats, consult your central station.
- **HEX values:** Some Data Digit values are higher than 9. These values are programmed by pressing the [*] key followed by another number. These values will display as HEX characters when entered. The HEX character values are as follows:

*0 = A *1 = B *2 = C *3 = D *4 = E *5 = F

See Glossary (section 6.13) for further details.

Report	Address	Default		Reporting Digit 1	Extended Digit 2
		↓			
Keypad Fire Alarm	0256	00			
Keypad Fire Restoral	0257	00			
Zone Funct. 1 Alarm	0258	10			
Zone Funct. 2 Alarm	0259	20			
Zone Funct. 3 Alarm	0260	30			
Zone Funct. 4 Alarm	0261	40			
Zone Funct. 5 Alarm	0262	50			
Zone Funct. 6 Alarm	0263	60			
Zone Funct. 7 Alarm	0264	70			
Zone Funct. 8 Alarm	0265	80			
Zone Funct. 9 Alarm	0266	00			
Zone Funct.10 Alarm	0267	00			
Zone Funct. 11 Alarm	0268	00			
Zone Funct. 12 Alarm	0269	00			
Zone Funct. 13 Alarm	0270	00			
Zone Funct. 14 Alarm	0271	00			
Zone Funct. 15 Alarm	0272	00			
Keypad Emergency	0273	00			
Keypad Panic	0274	00			
Zone Funct. 1 Restoral	0275	00			
Zone Funct. 2 Restoral	0276	00			
Zone Funct. 3 Restoral	0277	00			
Zone Funct. 4 Restoral	0278	00			
Zone Funct. 5 Restoral	0279	00			

Report	Address	Default		Reporting Digit 1	Extended Digit 2
		↓			
Zone Funct. 6 Restoral	0280	00			
Zone Funct. 7 Restoral	0281	00			
Zone Funct. 8 Restoral	0282	00			
Zone Funct. 9 Restoral	0283	00			
Zone Funct. 10 Restoral	0284	00			
Zone Funct. 11 Restoral	0285	00			
Zone Funct. 12 Restoral	0286	00			
Zone Funct. 13 Restoral	0287	00			
Zone Funct. 14 Restoral	0288	00			
Zone Funct. 15 Restoral	0289	00			
Zone Funct. 1 Trouble	0290	00			
Zone Funct. 2 Trouble	0291	00			
Zone Funct. 3 Trouble	0292	00			
Zone Funct. 4 Trouble	0293	00			
Zone Funct. 5 Trouble	0294	00			
Zone Funct. 6 Trouble	0295	00			
Zone Funct. 7 Trouble	0296	00			
Zone Funct. 8 Trouble	0297	00			
Zone Funct. 9 Trouble	0298	00			
Zone Funct. 10 Trouble	0299	00			
Zone Funct. 11 Trouble	0300	00			
Zone Funct. 12 Trouble	0301	00			
Zone Funct. 13 Trouble	0302	00			
Zone Funct. 14 Trouble	0303	00			

continued on next page

Report Programming (Continued)

Report	Address	Default		
		Reporting Digit 1	Extended Digit 1	Digit 2
Zone Funct. 15 Trouble	0304	00		
Zone Funct. 1 Trouble Restoral	0305	00		
Zone Funct. 2 Trouble Restoral	0306	00		
Zone Funct. 3 Trouble Restoral	0307	00		
Zone Funct. 4 Trouble Restoral	0308	00		
Zone Funct. 5 Trouble Restoral	0309	00		
Zone Funct. 6 Trouble Restoral	0310	00		
Zone Funct. 7 Trouble Restoral	0311	00		
Zone Funct. 8 Trouble Restoral	0312	00		
Zone Funct. 9 Trouble Restoral	0313	00		
Zone Funct. 10 Trouble Restoral	0314	00		
Zone Funct. 11 Trouble Restoral	0315	00		
Zone Funct. 12 Trouble Restoral	0316	00		
Zone Funct. 13 Trouble Restoral	0317	00		
Zone Funct. 14 Trouble Restoral	0318	00		
Zone Funct. 15 Trouble Restoral	0319	00		
Open	0320	00		
Close	0321	00		
Duress	0322	00		
Partial Close	0323	00		
First Open After Alarm	0324	00		
Low Battery	0325	00		
Low Battery Restoral	0326	00		
AC Failure	0327	00		
AC Restoral	0328	00		
Comm. Test/System Normal	0329	00		
Remote Program Successful	0330	00		
Remote Prog. Unsuccessful	0331	00		
Local Program Successful	0332	00		
Local Program Unsuccessful	0333	00		
System Trouble	0334	00		
System Trouble Restoral	0335	00		
Comm Test/System Off Norm	0336	00		
Exit Error	0337	00		
Recent Closing	0338	00		
System Walk Test	0339	00		
System Walk Test Restoral	0340	00		

Report	Address	Default		
		Reporting Digit 1	Extended Digit 1	Digit 2
Fire Walk Test	0341	00		
Fire Walk Test Restoral	0342	00		
Low Temperature	0343	00		
Low Temperature Restoral	0344	00		
Dirty Smoke Chamber	0345	00		
Dirty Chamber Restoral	0346	00		
Zone Funct. 1 Bypass	0347	00		
Zone Funct. 2 Bypass	0348	00		
Zone Funct. 3 Bypass	0349	00		
Zone Funct. 4 Bypass	0350	00		
Zone Funct. 5 Bypass	0351	00		
Zone Funct. 6 Bypass	0352	00		
Zone Funct. 7 Bypass	0353	00		
Zone Funct. 8 Bypass	0354	00		
Zone Funct. 9 Bypass	0355	00		
Zone Funct. 10 Bypass	0356	00		
Zone Funct. 11 Bypass	0357	00		
Zone Funct. 12 Bypass	0358	00		
Zone Funct. 13 Bypass	0359	00		
Zone Funct. 14 Bypass	0360	00		
Zone Funct. 15 Bypass	0361	00		
Zone Funct. 1 Bypass Restore	0362	00		
Zone Funct. 2 Bypass Restore	0363	00		
Zone Funct. 3 Bypass Restore	0364	00		
Zone Funct. 4 Bypass Restore	0365	00		
Zone Funct. 5 Bypass Restore	0366	00		
Zone Funct. 6 Bypass Restore	0367	00		
Zone Funct. 7 Bypass Restore	0368	00		
Zone Funct. 8 Bypass Restore	0369	00		
Zone Funct. 9 Bypass Restore	0370	00		
Zone Funct. 10 Bypass Restore	0371	00		
Zone Funct. 11 Bypass Restore	0372	00		
Zone Funct. 12 Bypass Restore	0373	00		
Zone Funct. 13 Bypass Restore	0374	00		
Zone Funct. 14 Bypass Restore	0375	00		
Zone Funct. 15 Bypass Restore	0376	00		
Keypad Tamper	0377	00		
Keypad Tamper Restoral	0378	00		

11.26 Phone/ARDIS Routing Control: Program Addresses (0494-0495)

If address 0528 is programmed to "Try ARDIS network first", the following addresses can be used to control report routing. If address 0528 is set to "Send alarms via both ARDIS and digital", this will force alarms to go to the phone even if the Phone/ARDIS report routing for alarms does not specify phone usage.

Select Options	Enter the DD as a:				
	1	2	3	7	*1 *5
Use Phone	●		●	●	●
Use ARDIS		●	●	●	●
Use Either			●		●
Use Both				●	●
Try Phone First				●	●

Select Options	Enter the DD as a:				
	1	2	3	7	*1 *5
Use Phone	●		●	●	●
Use ARDIS		●	●	●	●
Use Either			●		●
Use Both				●	●
Try Phone First				●	●

Phone/ARDIS report routing (0494).
First digit: Open and Close Reports.

Second digit: Zone Alarm, Zone Restoral, and Zone Trouble Reports.

Phone/ARDIS report routing and Phone First count (0495)

First Digit: System Reports.

Select Options	Enter the DD as a:				
	1	2	3	7	*1 *5
Use Phone	●		●	●	●
Use ARDIS		●	●	●	●
Use Either			●		●
Use Both				●	●
Try Phone First				●	●

Select Option	DD	Select Option	DD	Select Option	DD	Select Option	DD
0 Attempts	0	4 Attempts	4	8 Attempts	8	12 Attempts	*2
1 Attempt	1	5 Attempts	5	9 Attempts	9	13 Attempts	*3
2 Attempts	2	6 Attempts	6	10 Attempts	*0	14 Attempts	*4
3 Attempts	3	7 Attempts	7	11 Attempts	*1	15 Attempts	*5

Second digit: Phone First count. Number of attempts before trying ARDIS:

This value is used to control the number of attempts made on the phone line before switching to the ARDIS network. This value is only referenced if the "Use Phone", "Use ARDIS", and "Try Phone First" options are all selected. If the value is less than or equal to 2, or more than 5, two attempts will be made on the phone before trying ARDIS if the Phone First option is selected.

11.27 Account Code Programming: Program Addresses (0496-0526)

Example:

To program Partition 1 Phone #1 Account Code to be 2332.

Data Digit 1 = [2], Data Digit 2 = [3], Data Digit 3 = [3], Data Digit 4 = [2].

Enter the Programmer's Mode: [9] [8] [7] [6] [#] [0]
 Enter the Program Address: [0] [4] [9] [6]
 Enter Data Digit 1: [2]
 Enter Data Digit 2: [3]
 Enter Data Digit 1: [3]
 Enter Data Digit 2: [2]
 Enter the pound key: [#]
 Program the next Address, Program a different Address, or Exit the Programmer's Mode.

Account Code programming defines the number transmitted to the central station that identifies this panel. It also identifies which partition is reporting from this panel.

		Data Digits				
		1	2	3	4	
Partition 1	Phone #1 Account Code = Address 0496	→	<input type="text"/>	<input type="text"/>	<input type="text"/>	<input type="text"/>
	Phone #2 Account Code = Address 0498	→	<input type="text"/>	<input type="text"/>	<input type="text"/>	<input type="text"/>
Partition 2	Phone #1 Account Code = Address 0500	→	<input type="text"/>	<input type="text"/>	<input type="text"/>	<input type="text"/>
	Phone #2 Account Code = Address 0502	→	<input type="text"/>	<input type="text"/>	<input type="text"/>	<input type="text"/>
Partition 3	Phone #1 Account Code = Address 0504	→	<input type="text"/>	<input type="text"/>	<input type="text"/>	<input type="text"/>
	Phone #2 Account Code = Address 0506	→	<input type="text"/>	<input type="text"/>	<input type="text"/>	<input type="text"/>
Partition 4	Phone #1 Account Code = Address 0508	→	<input type="text"/>	<input type="text"/>	<input type="text"/>	<input type="text"/>
	Phone #2 Account Code = Address 0510	→	<input type="text"/>	<input type="text"/>	<input type="text"/>	<input type="text"/>
Partition 5	Phone #1 Account Code = Address 0512	→	<input type="text"/>	<input type="text"/>	<input type="text"/>	<input type="text"/>
	Phone #2 Account Code = Address 0514	→	<input type="text"/>	<input type="text"/>	<input type="text"/>	<input type="text"/>
Partition 6	Phone #1 Account Code = Address 0516	→	<input type="text"/>	<input type="text"/>	<input type="text"/>	<input type="text"/>
	Phone #2 Account Code = Address 0518	→	<input type="text"/>	<input type="text"/>	<input type="text"/>	<input type="text"/>
Partition 7	Phone #1 Account Code = Address 0520	→	<input type="text"/>	<input type="text"/>	<input type="text"/>	<input type="text"/>
	Phone #2 Account Code = Address 0522	→	<input type="text"/>	<input type="text"/>	<input type="text"/>	<input type="text"/>
Partition 8	Phone #1 Account Code = Address 0524	→	<input type="text"/>	<input type="text"/>	<input type="text"/>	<input type="text"/>
	Phone #2 Account Code = Address 0526	→	<input type="text"/>	<input type="text"/>	<input type="text"/>	<input type="text"/>

**The Default for all
Account Codes = 0000**

NOTES

- Account Codes are programmed from left to right. If programming a 3 digit Account Code, the fourth digit of the address must be "0." For example: If the Account Code is 121, program 1210 in the programming address.
- If you wish to send a zero "0," enter it as *0 (this does not apply to the added zero in a three digit Account Code). For example: If the Account Code is 101, program 1*010 in the programming address. If the Account Code is 3050, program 3*05*0 in the programming address.

11.28 Phone Number General Control Programming: Program Address (0528)

Example:

To program the parameters to enable the Remote Programmer Call-back feature, to dial Pulse on all Phone Numbers, to send Alarm Reports via either ARDIS or Digital, and to use 110 Baud comm. for WDSRP.

Data Digit 1 = [1], Data Digit 2 = [0].

Enter the Programmer's Mode: [9] [8] [7] [6] [#] [0]

Enter the Program Address: [0] [5] [2] [8]

Enter Data Digit 1: [1]

Enter Data Digit 2: [0]

Enter the pound key: [#]

Program the next Address, Program a different Address, or Exit the Programmer's Mode.

See Glossary (section 6.14) for further details.

Select Options	Enter the Data Digit as a:											Data Digit		
	0	1	2	3	4	5	6	7	8	9	*0	*1	1	2
Enable remote programmer call-back		●		●		●		●		●		●		
Dial pulse on all phone numbers	●	●				●	●							
Dial tone on all phone numbers**				●	●						●	●		
Dial tone, switch to pulse if required			●	●					●	●				
ΔΔ Try ARDIS network first						●	●	●	●	●	●			

*0 - *1 are Hex values. They will display as A - B at the keypads.

ΔΔ = If this option is selected, see address 0494-0495.

** = Required on PBX systems

Select Options	Enter the Data Digit as a:															
	0	1	2	3	4	5	6	7	8	9	*0	*1	*2	*3	*4	*5
Dialer delay of 15 sec. on non-24H burglar alarms only**		●		●		●		●		●		●		●		●
Dialer delay of 15 sec. on 24H burglar & fire alarms only**			●	●			●	●			●	●			●	●
Send alarms via either ARDIS or digital Δ	●	●	●	●					●	●	●	●				
ΔΔSend alarms via both ARDIS and digital Δ***					●	●	●	●					●	●	●	●
Use 110 Baud comm. for WDSRP	●	●	●	●	●	●	●	●								
Use 300 Baud comm. for WDSRP									●	●	●	●	●	●	●	●

*0 - *5 are Hex values. They will display as A - F at the keypads.

Δ = Only applicable when using the ARDIS option.

ΔΔ = If this option is selected, see address 0494-0495.

** = These selections can only be used with systems that have only one partition.

*** = This selection must be chosen for U. L. Listed Requirements when using the ARDIS module.

11.29 Phone Number Format Programming: Program Addresses (0529-0530)

Select Option	DD	Enter the DD as a:						Data Digit	
		0	1	2	3	4	5	1	2
Phone Number Disabled	0								
3/1 (no Extended Reporting)	1								
3/1E (Extended Reporting)	2								
3/1 with Parity	3								
3/1E with Parity	4								
4/1	5								
4/2	6								
BFSK	7		●						
SIA 110 Baud	8								
Contact ID	9								
SIA 300 Baud	*0								
Personal Dialing	*2								
Pager	*5								
1900 Hz. Data/1400 Hz. Acknowledge		●		●		●			
1800 Hz. Data/2300 Hz. Acknowledge			●		●		●		
BFSK, SIA, Contact ID			●						
10 Pulses per Second (PPS)		●	●						
20 Pulses per Second (PPS)				●	●				
40 Pulses per Second (PPS)						●	●		

*0 and *5 are Hex values. They will display as A and F at the keypads.

NOTE

Phone Number 1 Format = Address 0529

Phone Number 2 Format = Address 0530

When using the ARDIS communications module:

Program address 0529 as: data digit 1 = 9, data digit 2 = 1.

Program address 0530 as: data digit 1 = 9, data digit 2 = 1.

11.29.1 Compatible Receivers

The following table lists those Digital Alarm Communicator Receivers and Formats that are compatible with the DS7400Xi.

NOTE Contact your central station regarding which format to use and if a special line card is required.

Receiver	Format								
	3/1	3/1 E (Extended)	3/1 w/Parity	3/1 E w/Parity	4/1	4/2	BFSK	Contact ID	SIA
ADEMCO: Model 685	●	●	●	●	●	●	●	●	
F.B.I.: Model CP-220	●	●	●	●	●	●	●	●	
I.T.I.: Model CS-4000	●	●			●	●	●		
Osborne-Hoffman: Model II	●	●	●	●	●	●	●	●	●
Radionics: Model 6000	●	●	●	●			●		
Radionics: Model 6500	●	●	●	●	●	●	●		
Radionics: Model 6600	●	●	●	●	●	●	●	●	●
Silent Knight: Model 9000	●	●	●	●	●	●	●		●
Varitech: Model V-300	●	●	●	●	●	●	●		

1 = The Format type the DS7400Xi supports and the Digital Alarm Communicator Receiver accepts.

11.30 Phone Answering Programming: Program Address (0531)

Example:

To program the Control Panel to answer the Phone after 2 rings when Armed and after 4 rings when Disarmed.

Data Digit 1 = [2], Data Digit 2 = [4].

Enter the Programmer's Mode:
[9] [8] [7] [6] [#] [0]

Enter the Program Address:
[0] [5] [3] [1]

Enter Data Digit 1: [2]
Enter Data Digit 2: [4]
Enter the pound key: [#]

Program the next Address, Program a different Address, or Exit the Programmer's Mode.

See Glossary (section 6.15) for further details.

Select Option	
When Armed:	
Don't Answer Phone	0
Answer Phone on 1 ring**	1
Answer Phone on 2 rings	2
Answer Phone on 3 rings**	3
Answer Phone on 4 rings	4
Answer Phone on 5 rings**	5
Answer Phone on 6 rings	6
Answer Phone on 7 rings**	7
Answer Phone on 8 rings	8
Answer Phone on 9 rings**	9
Answer Phone on 10 rings	*0
Answer Phone on 11 rings**	*1
Answer Phone on 12 rings	*2
Answer Phone on 13 rings**	*3
Answer Phone on 14 rings	*4
Answer Phone on 15 rings**	*5

*0 - *5 are Hex values.
They will display as A - F at the keypads.

** = Overrides answering machine.
The Panel will answer on the first ring of the second call made within one minute.

Select Option	
When Disarmed:	
Don't Answer Phone	0
Answer Phone on 1 ring**	1
Answer Phone on 2 rings	2
Answer Phone on 3 rings**	3
Answer Phone on 4 rings	4
Answer Phone on 5 rings**	5
Answer Phone on 6 rings	6
Answer Phone on 7 rings**	7
Answer Phone on 8 rings	8
Answer Phone on 9 rings**	9
Answer Phone on 10 rings	*0
Answer Phone on 11 rings**	*1
Answer Phone on 12 rings	*2
Answer Phone on 13 rings**	*3
Answer Phone on 14 rings	*4
Answer Phone on 15 rings**	*5

*0 - *5 are Hex values.
They will display as A - F at the keypads.

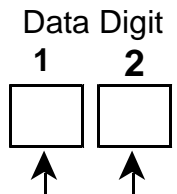

11.31 Programmer's and Master Code Programming: Programming Addresses (0532-0534)

Example:
 To program the Programmer's Code to be 3 4 4 3.

Data Digit 1 = [3], Data Digit 2 = [4],
 Data Digit 3 = [4], Data Digit 4 = [3].

Enter the Programmer's Mode: [9] [8] [7] [6] [#] [0]
 Enter the Program Address: [0] [5] [3] [2]
 Enter Data Digit 1: [3]
 Enter Data Digit 2: [4]
 Enter Data Digit 3: [4]
 Enter Data Digit 4: [3]
 Enter the pound key: [#]
 Program the next Address, Program a different Address, or Exit the Programmer's Mode.

Programmer's Code programming defines what the Programmer's Code will be. This code is used to enter the programming mode from the keypads.

Programmer's Code
 Enter as 4 digits.
 It can not be the same as any PIN number.

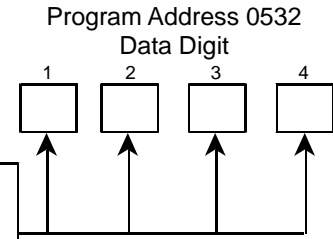

The Default for the Programmer's Code = 9876

Master Code programming defines what the Master Code will be. This code is the highest authority level for a PIN.

If the Master Code is lost, this address may be used to program a new one. Otherwise, the Master Code Programming Mode should be used to create PINs that have a Master Code authority level.

Master Code for User Number 001 has its authority fixed at level 0. It will always have access to all partitions.

NOTE

User Numbers 002 through 090 must be programmed from the Master Code Programming Mode.

Master Code PIN Number
 (Default for this User 001 is 1234)

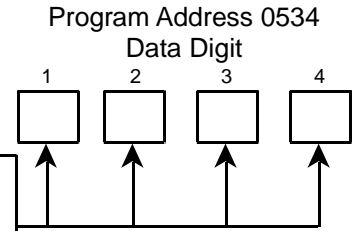

11.32 Octal Relay Module Output Programming: Program Addresses (1456-1471)

Example:
 To program the Octal Relay Module's Output # 9 to follow Output Function 1.

Data Digit 1 = [*] [3], Data Digit 2 = [1],

Enter the Programmer's Mode: [9] [8] [7] [6] [#] [0]
 Enter the Program Address: [1] [4] [6] [4]
 Enter Data Digit 1: [*] [3]
 Enter Data Digit 2: [1]
 Enter the pound key: [#]
 Program the next Address, Program a different Address, or Exit the Programmer's Mode.

The Octal Relay Module is the DS7488. See sections 1.14 and 6.4 for further details.

Select Option	DD
Latch ON after Zone Alarm**	0
ON during Entry Pre-Alert	1
ON for 10 sec. after pressing [System Reset]	2
ON when System is Armed	3
Ground Start	4
System Status (Ready to Arm)	5
Zone Alarm	6
Zone Alarm delayed by 20 seconds	7
Keypad Sounder Output	8
Access Output (10 sec. pulse)	9
Panic/Duress Output***	*1
Follow System Wide Events	*2
Follow Output Functions	*3

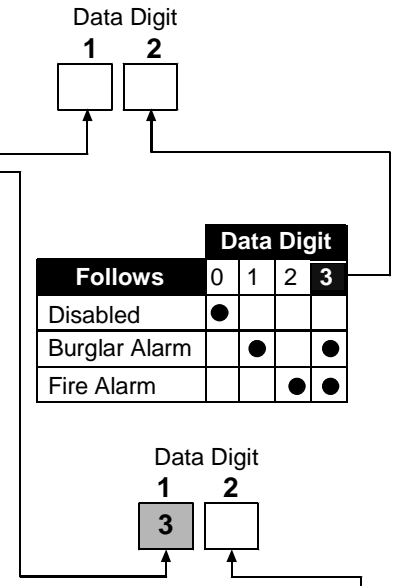

Octal Relay #	DS7488-1 Addresses
1	1456
2	1457
3	1458
4	1459
5	1460
6	1461
7	1462
8	1463

Octal Relay #	DS7488-2 Addresses
9	1464
10	1465
11	1466
12	1467
13	1468
14	1469
15	1470
16	1471

These two charts are for programming the Octal Relay Module to follow events by partition.

Octal Relay partition assignments are programmed in addresses 3725-3732. See Section 11.32.1

See next page for programming options *2 and *3
 ** = This includes invisible zones. See glossary for further details.
 *** = See section 6.4 for description of this option.

Follows	0	1	2	3
Disabled	●			
Armed Full		●		
Armed Partial			●	
Armed Any				●

Continued on next page

11.32 Octal Relay Module Output Programming: Program Addresses (1456-1471) (Continued)

Select Option	DD
Disabled	0
AC Power Fail	1
Low Battery	2
Communicator Failure	3
System Fault (Any)	4
Keypad Supervision Fault	5
Multiplex Bus Fault	6
Aux Power Fault	8
Fire Zone Trouble	9
Supervisory	*0
Zone Trouble	*1
Duress	*2
Battery Test	*3

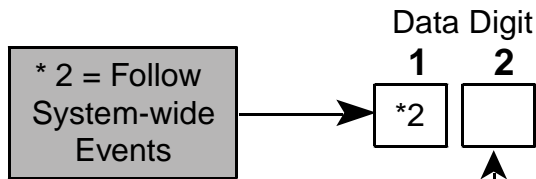

*0 - *3 are Hex values.
They will display as A - D at the keypads.

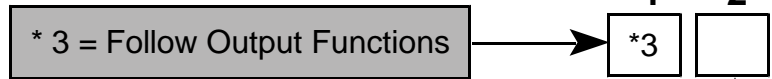

Select Option	DD
Disabled	0
Follow Output Function 1	1
Follow Output Function 2	2
Follow Output Function 3	3
Follow Output Function 4	4
Follow Output Function 5	5
Follow Output Function 6	6
Follow Output Function 7	7
Follow Output Function 8	8
Follow Output Function 9	9
Follow Output Function 10	*0
Follow Output Function 11	*1
Follow Output Function 12	*2
Follow Output Function 13	*3
Follow Output Function 14	*4
Follow Output Function 15	*5

*0 - *5 are Hex values.
They will display as A - F at the keypads.

The Octal Relay Module is the DS7488.
See section 1.18 for further details.

To have the DS7488's relays follow the Output Functions, program Data Digit 1 of this address as a *3, then program data digit 2 as shown.

See Glossary (section 6.4) for further details.

To program the Output Functions, see section 11.33. Up to 15 Output Functions may be programmed.

11.32.1 Octal Relay Module Output Partition Assignment: Program Addresses (3725-3732)

Program Address 3725

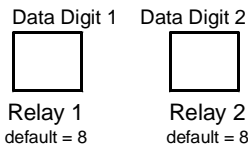

Program Address 3726

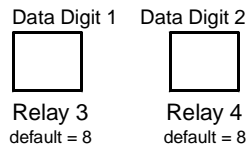

Program Address 3727

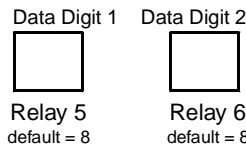

Program Address 3728

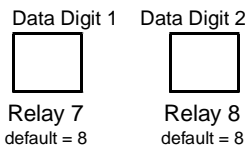

Program Address 3729

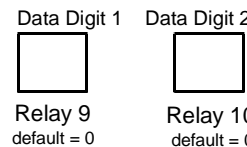

Program Address 3730

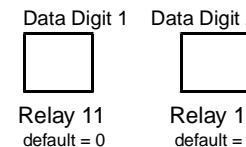

Program Address 3731

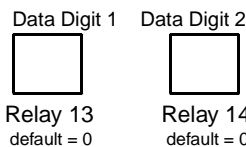

Program Address 3732

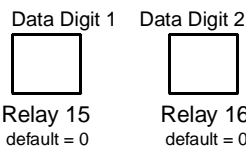

Select Option	DD
Belongs to Partition 1	0
Belongs to Partition 2	1
Belongs to Partition 3	2
Belongs to Partition 4	3
Belongs to Partition 5	4
Belongs to Partition 6	5
Belongs to Partition 7	6
Belongs to Partition 8	7
Follows all Partitions	8

11.33 Output Function Programming: Program Addresses (1472-1516)

Output programming allows you to have the Outputs follow status events by partition or system-wide, or follow zone outputs in an Input/Output Cross Matrix. See the Programming Addresses Worksheet (P/N 29802) for a description of each address. See Glossary (section 6.4) for further details.

*0 - *5 are Hex values. They will display as A - F at the keypads.

Select Option	DD
Latch ON after Zone Alarm	0
ON during Entry Pre-Alert	1
ON when system is armed	3
Zone alarm	6
Zone Alarm delayed by 20 sec.	7
Keypad Sounder output	8
Access output (10 sec. pulse)	9
Panic/Duress output**	*1
Follow System Status Event	*2
Follow a single zone	*3
Follow two zones-When EITHER zone changes state	*4
Follow two zones-When BOTH zones change state	*5

	Data Digit			
Follows	0	1	2	3
Disabled	●			
Burglar Alarm		●		●
Fire Alarm			●	●

Data Digit 1 Options 1-*1 are used to program an Output Function to follow status events for individual partitions.

Data Digit 1 Option *2 is used to program an Output Function to follow status events system-wide.

Data Digit 1 Options *3-*5 are used to program an Output Function to follow a zone or two zones in an Input/Output Cross Matrix.

Output Function Number	Program Address 1	Program Address 2	Program Address 3
1	1472	1473	1474
2	1475	1476	1477
3	1478	1479	1480
4	1481	1482	1483
5	1484	1485	1486
6	1487	1488	1489
7	1490	1491	1492
8	1493	1494	1495
9	1496	1497	1498
10	1499	1500	1501
11	1502	1503	1504
12	1505	1506	1507
13	1508	1509	1510
14	1511	1512	1513
15	1514	1515	1516

Select Option	DD	DD	Select Option
AC Power Failure	1	7	Radio Receiver Fault
Low Battery	2	8	Aux Power Fault
Communication Failure	3	9	Fire Trouble
System Fault (any)	4	*0	Supervisory
Keypad Supervision Fault	5	*1	Zone Trouble
Multiplex Bus Fault	6	*2	Duress PIN

*0 - *2 are Hex values. They will display as A - C at the keypads.

Program Address 1	Program Address 2	Program Address 3
Data Digit 1	Data Digit 2	Data Digit 1
Data Digit 2	Data Digit 1	Data Digit 2
Data Digit 1	Data Digit 2	Data Digit 1
Data Digit 2	Data Digit 1	Data Digit 2

Enter Data Digit as a:													
Activate:	0	1	2	3	4	5	6	7	8	9	*0	*1	*2
Disabled	●												
When zone is shorted		●	●	●	●	●	●	●	●	●	●	●	●
When Zone is opened			●		●		●		●		●		●
When panel is Armed		●	●			●	●	●	●			●	●
When panel is not Armed				●	●	●	●			●	●	●	●
Latch when activated**								●	●	●	●	●	●

Enter the Zone Number of First Zone to Follow (01 - 99)

Enter the Zone Number of Second Zone to Follow (01 - 99)

Not Required if following a single zone

** = This is only for DS7465 Outputs. DS7488 Outputs will not latch when this is selected.

11.33.1 Output Function Partition Assignment: Program Addresses (3733-3740)

Program Address 3733

Data Digit 1	Data Digit 2
<input type="text"/>	<input type="text"/>
Function 1	Function 2

Program Address 3734

Data Digit 1	Data Digit 2
<input type="text"/>	<input type="text"/>
Function 3	Function 4

Program Address 3735

Data Digit 1	Data Digit 2
<input type="text"/>	<input type="text"/>
Function 5	Function 6

Program Address 3736

Data Digit 1	Data Digit 2
<input type="text"/>	<input type="text"/>
Function 7	Function 8

Program Address 3737

Data Digit 1	Data Digit 2
<input type="text"/>	<input type="text"/>
Function 9	Function 10

Program Address 3738

Data Digit 1	Data Digit 2
<input type="text"/>	<input type="text"/>
Function 11	Function 12

Program Address 3739

Data Digit 1	Data Digit 2
<input type="text"/>	<input type="text"/>
Function 13	Function 14

Program Address 3740

Data Digit 1	Data Digit 2
<input type="text"/>	<input type="text" value="0"/>
Function 15	Must Be 0

Select Option	DD
Belongs to Partition 1	0
Belongs to Partition 2	1
Belongs to Partition 3	2
Belongs to Partition 4	3
Belongs to Partition 5	4
Belongs to Partition 6	5
Belongs to Partition 7	6
Belongs to Partition 8	7
Follows all Partitions	8

11.34 Dual Phone Line/Bell Supervision Module Output Programming: Program Address (1520)

Example:

To program the Dual Phone Line/Bell Supervision Module to supervise Phone Line 1 and Phone Line 2.

Data Digit 1 = [2], Data Digit 2 = [0].

Enter the Programmer's Mode: [9] [8] [7] [6] [#] [0]
 Enter the Program Address: [1] [5] [2] [0]
 Enter Data Digit 1: [2]
 Enter Data Digit 2: [0]
 Enter the pound key: [#]
 Program the next Address, Program a different Address, or Exit the Programmer's Mode.

The Dual Phone Line/Bell Supervision Module is the DS7420i. See section 1.18 for further details.

When in Central Station or Local Commercial Fire Mode, this address will be forced to specific values (see section 11.15.1 and 11.15.2).

Options	Enter the Data Digit as a:									
	0	1	2	3	4	5	6	7	8	9
Disabled	●									
Bell Monitor				●	●	●			●	●
Phone Line 1 Monitor		●	●		●	●	●	●	●	●
Phone Line 2 Monitor			●			●		●		●
Alarm Output on line fault							●	●	●	●

Data Digit

1	2
<input type="text"/>	<input type="text" value="0"/>

Data Digit 2 must be a 0.

11.35 Call-Out Timer Programming: Program Addresses (1521-1524)

Example:

To program the Remote Programmer Call-Out hour and minute as 2:30 pm.

Hour: Data Digit 1 = [1], Data Digit 2 = [4].
 Minute: Data Digit 1 = [3], Data Digit 2 = [0].

Enter the Programmer's Mode: [9] [8] [7] [6] [#] [0]
 Enter the Program Address: [1] [5] [2] [3]
 Enter Data Digit 1: [1]
 Enter Data Digit 2: [4]
 Enter the pound key: [#] (will go to Address 1524)
 Enter Data Digit 1: [3]
 Enter Data Digit 2: [0]
 Enter the pound key: [#]
 Program the next Address, Program a different Address, or Exit the Programmer's Mode.

This section allows you to define the Hour and Minute for the Communicator Test Report and Remote Programmer Call-Out.

The default time for the Communicator Test Report to be sent and for the control to call the Remote Programmer is Midnight.

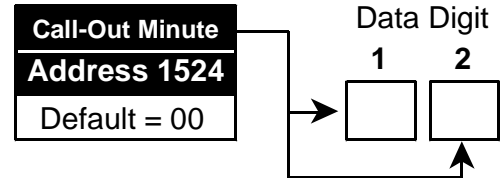
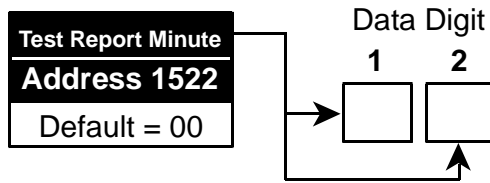
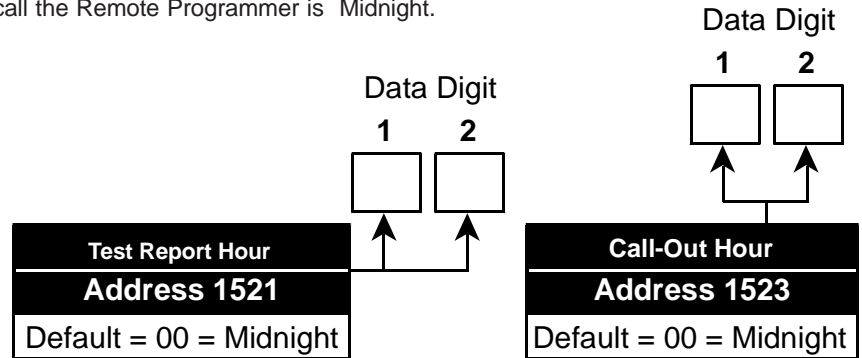

11.36 Test Report and Remote Programmer Call-Out Programming: Program Address (1525)

This section allows you to define the Day and Frequency for the Communicator Test Report and the Remote Programmer Call-Out.

If this address is not programmed, the Communicator Test Report will not be sent and the control will not call the Remote Programmer.

Example:

To send Test Reports on Sundays, and to call the Remote Programmer on Saturdays.

Data Digit 1 = [1], Data Digit 2 = [7].

Enter the Programmer's Mode: [9] [8] [7] [6] [#] [0]
 Enter the Program Address: [1] [5] [2] [5]
 Enter Data Digit 1: [1]
 Enter Data Digit 2: [7]
 Enter the pound key: [#]
 Program the next Address, Program a different Address, or Exit the Programmer's Mode.

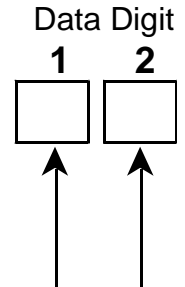

Select Option	DD
Do not send a Test Report	0
Send a Test Report on Sunday	1
Send a Test Report on Monday	2
Send a Test Report on Tuesday	3
Send a Test Report on Wednesday	4
Send a Test Report on Thursday	5
Send a Test Report on Friday	6
Send a Test Report on Saturday	7
Send a Test Report every day	8
Send a Test Report every 8 days	9
Send a Test Report every 28 days	*0
Send a Test Report every hour	*1
Send a Test Report every 12 hours	*2

*0 - *2 are Hex values.
 They will display as A - C at the keypads.

Select Option	DD
Do not call the Remote Programmer	0
Call the Remote Programmer on Sunday	1
Call the Remote Programmer on Monday	2
Call the Remote Programmer on Tuesday	3
Call the Remote Programmer on Wednesday	4
Call the Remote Programmer on Thursday	5
Call the Remote Programmer on Friday	6
Call the Remote Programmer on Saturday	7
Call the Remote Programmer every day	8
Call the Remote Programmer every 8 days	9
Call the Remote Programmer every 28 days	*0

11.37 Alpha Description Programming: Program Addresses (1526-3701)

Alpha Description Programming allows up to 16 characters to be programmed for the description of each partition or zone (e.g. "J. Hill's Office"). If a description is less than 16 characters, leave the remaining address(es) blank. Once programmed, the descriptions will be displayed on the alpha keypads.

The following chart lists the Program Addresses used to program Alpha-Numeric characters for each partition or zone:

Partition 1 Program Address 1526 - 1541	Partition 5 Program Address 1590 - 1605	Zone 1 Program Address 1654 - 1669	Zone 5 Program Address 1718 - 1733
Partition 2 Program Address 1542 - 1557	Partition 6 Program Address 1606 - 1621	Zone 2 Program Address 1670 - 1685	Zone 6 Program Address 1734 - 1749
Partition 3 Program Address 1558 - 1573	Partition 7 Program Address 1622 - 1637	Zone 3 Program Address 1686 - 1701	Zone 7 Program Address 1750 - 1765
Partition 4 Program Address 1574 - 1589	Partition 8 Program Address 1638 - 1653	Zone 4 Program Address 1702 - 1717	Zone 8 Program Address 1766 - 1781
Program Addresses Zones 9 through 128 1782 through 3701 (16 addresses per zone)			

See Section 11.37.1 for an Alpha Description Programming worksheet for Partitions 1 through 8 and Zones 1 through 8. See the Programming Addresses Worksheet (P/N 29802) for a complete Alpha Programming Worksheet (covering addresses 1526 through 3701).

Words are created one character at a time. Each character uses two data digits.
The data digit values for these characters are shown below:

Value	Character	Value	Character	Value	Character	Value	Character
02	blank space	83	8	05	P	86	h
12	!	93	9	15	Q	96	i
22	"	*03	:	25	R	*06	j
32	#	*13	;	35	S	*16	k
42	\$	*23	<	45	T	*26	l
52	%	*33	=	55	U	*36	m
62	&	*43	>	65	V	*46	n
72	'	*53	?	75	W	*56	o
82	(04	@	85	X	07	p
92)	14	A	95	Y	17	q
*02	*	24	B	*05	Z	27	r
*12	+	34	C	*15	[37	s
*22	,	44	D	*25	¥	47	t
*32	-	54	E	*35]	57	u
*42	.	64	F	*45	^	67	v
*52	/	74	G	*55	_	77	w
03	0	84	H	06	'	87	x
13	1	94	I	16	a	97	y
23	2	*04	J	26	b	*07	z
33	3	*14	K	36	c	*17	{
43	4	*24	L	46	d	*27	
53	5	*34	M	56	e	*37	}
63	6	*44	N	66	f	*47	→
73	7	*54	O	76	g		

Example

	Character 1	Character 2	Character 3	Character 4	Character 5	Character 6	Character 7	Character 8
Text	C	H	E	M	I	C	A	L
Value	3 4	8 4	5 4	*3 4	9 4	3 4	1 4	*2 4
	1526-1 1526-2	1527-1 1527-2	1528-1 1528-2	1529-1 1529-2	1530-1 1530-2	1531-1 1531-2	1532-1 1532-2	1533-1 1533-2

11.37.1 Alpha Description Programming: A Worksheet

Partition 1

	Character 1	Character 2	Character 3	Character 4	Character 5	Character 6	Character 7	Character 8
Text	<input type="text"/>	<input type="text"/>	<input type="text"/>	<input type="text"/>	<input type="text"/>	<input type="text"/>	<input type="text"/>	<input type="text"/>
Value	<input type="text"/> 1526-1 1526-2	<input type="text"/> 1527-1 1527-2	<input type="text"/> 1528-1 1528-2	<input type="text"/> 1529-1 1529-2	<input type="text"/> 1530-1 1530-2	<input type="text"/> 1531-1 1531-2	<input type="text"/> 1532-1 1532-2	<input type="text"/> 1533-1 1533-2
	Character 9	Character 10	Character 11	Character 12	Character 13	Character 14	Character 15	Character 16
Text	<input type="text"/>	<input type="text"/>	<input type="text"/>	<input type="text"/>	<input type="text"/>	<input type="text"/>	<input type="text"/>	<input type="text"/>
Value	<input type="text"/> 1534-1 1534-2	<input type="text"/> 1535-1 1535-2	<input type="text"/> 1536-1 1536-2	<input type="text"/> 1537-1 1537-2	<input type="text"/> 1538-1 1538-2	<input type="text"/> 1539-1 1539-2	<input type="text"/> 1540-1 1540-2	<input type="text"/> 1541-1 1541-2

Partition 2

	Character 1	Character 2	Character 3	Character 4	Character 5	Character 6	Character 7	Character 8
Text	<input type="text"/>	<input type="text"/>	<input type="text"/>	<input type="text"/>	<input type="text"/>	<input type="text"/>	<input type="text"/>	<input type="text"/>
Value	<input type="text"/> 1542-1 1542-2	<input type="text"/> 1543-1 1543-2	<input type="text"/> 1544-1 1544-2	<input type="text"/> 1545-1 1545-2	<input type="text"/> 1546-1 1546-2	<input type="text"/> 1547-1 1547-2	<input type="text"/> 1548-1 1548-2	<input type="text"/> 1549-1 1549-2
	Character 9	Character 10	Character 11	Character 12	Character 13	Character 14	Character 15	Character 16
Text	<input type="text"/>	<input type="text"/>	<input type="text"/>	<input type="text"/>	<input type="text"/>	<input type="text"/>	<input type="text"/>	<input type="text"/>
Value	<input type="text"/> 1550-1 1550-2	<input type="text"/> 1551-1 1551-2	<input type="text"/> 1552-1 1552-2	<input type="text"/> 1553-1 1553-2	<input type="text"/> 1554-1 1554-2	<input type="text"/> 1555-1 1555-2	<input type="text"/> 1556-1 1556-2	<input type="text"/> 1557-1 1557-2

Partition 3

	Character 1	Character 2	Character 3	Character 4	Character 5	Character 6	Character 7	Character 8
Text	<input type="text"/>	<input type="text"/>	<input type="text"/>	<input type="text"/>	<input type="text"/>	<input type="text"/>	<input type="text"/>	<input type="text"/>
Value	<input type="text"/> 1558-1 1558-2	<input type="text"/> 1559-1 1559-2	<input type="text"/> 1560-1 1560-2	<input type="text"/> 1561-1 1561-2	<input type="text"/> 1562-1 1562-2	<input type="text"/> 1563-1 1563-2	<input type="text"/> 1564-1 1564-2	<input type="text"/> 1565-1 1565-2
	Character 9	Character 10	Character 11	Character 12	Character 13	Character 14	Character 15	Character 16
Text	<input type="text"/>	<input type="text"/>	<input type="text"/>	<input type="text"/>	<input type="text"/>	<input type="text"/>	<input type="text"/>	<input type="text"/>
Value	<input type="text"/> 1566-1 1566-2	<input type="text"/> 1567-1 1567-2	<input type="text"/> 1568-1 1568-2	<input type="text"/> 1569-1 1569-2	<input type="text"/> 1570-1 1570-2	<input type="text"/> 1571-1 1571-2	<input type="text"/> 1572-1 1572-2	<input type="text"/> 1573-1 1573-2

Partition 4

	Character 1	Character 2	Character 3	Character 4	Character 5	Character 6	Character 7	Character 8
Text	<input type="text"/>	<input type="text"/>	<input type="text"/>	<input type="text"/>	<input type="text"/>	<input type="text"/>	<input type="text"/>	<input type="text"/>
Value	<input type="text"/> 1574-1 1574-2	<input type="text"/> 1575-1 1575-2	<input type="text"/> 1576-1 1576-2	<input type="text"/> 1577-1 1577-2	<input type="text"/> 1578-1 1578-2	<input type="text"/> 1579-1 1579-2	<input type="text"/> 1580-1 1580-2	<input type="text"/> 1581-1 1581-2
	Character 9	Character 10	Character 11	Character 12	Character 13	Character 14	Character 15	Character 16
Text	<input type="text"/>	<input type="text"/>	<input type="text"/>	<input type="text"/>	<input type="text"/>	<input type="text"/>	<input type="text"/>	<input type="text"/>
Value	<input type="text"/> 1582-1 1582-2	<input type="text"/> 1583-1 1583-2	<input type="text"/> 1584-1 1584-2	<input type="text"/> 1585-1 1585-2	<input type="text"/> 1586-1 1586-2	<input type="text"/> 1587-1 1587-2	<input type="text"/> 1588-1 1588-2	<input type="text"/> 1589-1 1589-2

11.37.1 Alpha Description Programming: A Worksheet (Continued)

Partition 5

	Character 1	Character 2	Character 3	Character 4	Character 5	Character 6	Character 7	Character 8
Text	<input type="text"/>	<input type="text"/>	<input type="text"/>	<input type="text"/>	<input type="text"/>	<input type="text"/>	<input type="text"/>	<input type="text"/>
Value	<input type="text"/> 1590-1 1590-2	<input type="text"/> 1591-1 1591-2	<input type="text"/> 1592-1 1592-2	<input type="text"/> 1593-1 1593-2	<input type="text"/> 1594-1 1594-2	<input type="text"/> 1595-1 1595-2	<input type="text"/> 1596-1 1596-2	<input type="text"/> 1597-1 1597-2

	Character 9	Character 10	Character 11	Character 12	Character 13	Character 14	Character 15	Character 16
Text	<input type="text"/>	<input type="text"/>	<input type="text"/>	<input type="text"/>	<input type="text"/>	<input type="text"/>	<input type="text"/>	<input type="text"/>
Value	<input type="text"/> 1598-1 1598-2	<input type="text"/> 1599-1 1599-2	<input type="text"/> 1600-1 1600-2	<input type="text"/> 1601-1 1601-2	<input type="text"/> 1602-1 1602-2	<input type="text"/> 1603-1 1603-2	<input type="text"/> 1604-1 1604-2	<input type="text"/> 1605-1 1605-2

Partition 6

	Character 1	Character 2	Character 3	Character 4	Character 5	Character 6	Character 7	Character 8
Text	<input type="text"/>	<input type="text"/>	<input type="text"/>	<input type="text"/>	<input type="text"/>	<input type="text"/>	<input type="text"/>	<input type="text"/>
Value	<input type="text"/> 1606-1 1606-2	<input type="text"/> 1607-1 1607-2	<input type="text"/> 1608-1 1608-2	<input type="text"/> 1609-1 1609-2	<input type="text"/> 1610-1 1610-2	<input type="text"/> 1611-1 1611-2	<input type="text"/> 1612-1 1612-2	<input type="text"/> 1613-1 1613-2

	Character 9	Character 10	Character 11	Character 12	Character 13	Character 14	Character 15	Character 16
Text	<input type="text"/>	<input type="text"/>	<input type="text"/>	<input type="text"/>	<input type="text"/>	<input type="text"/>	<input type="text"/>	<input type="text"/>
Value	<input type="text"/> 1614-1 1614-2	<input type="text"/> 1615-1 1615-2	<input type="text"/> 1616-1 1616-2	<input type="text"/> 1617-1 1617-2	<input type="text"/> 1618-1 1618-2	<input type="text"/> 1619-1 1619-2	<input type="text"/> 1620-1 1620-2	<input type="text"/> 1621-1 1621-2

Partition 7

	Character 1	Character 2	Character 3	Character 4	Character 5	Character 6	Character 7	Character 8
Text	<input type="text"/>	<input type="text"/>	<input type="text"/>	<input type="text"/>	<input type="text"/>	<input type="text"/>	<input type="text"/>	<input type="text"/>
Value	<input type="text"/> 1622-1 1622-2	<input type="text"/> 1623-1 1623-2	<input type="text"/> 1624-1 1624-2	<input type="text"/> 1625-1 1625-2	<input type="text"/> 1626-1 1626-2	<input type="text"/> 1627-1 1627-2	<input type="text"/> 1628-1 1628-2	<input type="text"/> 1629-1 1629-2

	Character 9	Character 10	Character 11	Character 12	Character 13	Character 14	Character 15	Character 16
Text	<input type="text"/>	<input type="text"/>	<input type="text"/>	<input type="text"/>	<input type="text"/>	<input type="text"/>	<input type="text"/>	<input type="text"/>
Value	<input type="text"/> 1630-1 1630-2	<input type="text"/> 1631-1 1631-2	<input type="text"/> 1632-1 1632-2	<input type="text"/> 1633-1 1633-2	<input type="text"/> 1634-1 1634-2	<input type="text"/> 1635-1 1635-2	<input type="text"/> 1636-1 1636-2	<input type="text"/> 1637-1 1637-2

Partition 8

	Character 1	Character 2	Character 3	Character 4	Character 5	Character 6	Character 7	Character 8
Text	<input type="text"/>	<input type="text"/>	<input type="text"/>	<input type="text"/>	<input type="text"/>	<input type="text"/>	<input type="text"/>	<input type="text"/>
Value	<input type="text"/> 1638-1 1638-2	<input type="text"/> 1639-1 1639-2	<input type="text"/> 1640-1 1640-2	<input type="text"/> 1641-1 1641-2	<input type="text"/> 1642-1 1642-2	<input type="text"/> 1643-1 1643-2	<input type="text"/> 1644-1 1644-2	<input type="text"/> 1645-1 1645-2

	Character 9	Character 10	Character 11	Character 12	Character 13	Character 14	Character 15	Character 16
Text	<input type="text"/>	<input type="text"/>	<input type="text"/>	<input type="text"/>	<input type="text"/>	<input type="text"/>	<input type="text"/>	<input type="text"/>
Value	<input type="text"/> 1646-1 1646-2	<input type="text"/> 1647-1 1647-2	<input type="text"/> 1648-1 1648-2	<input type="text"/> 1649-1 1649-2	<input type="text"/> 1650-1 1650-2	<input type="text"/> 1651-1 1651-2	<input type="text"/> 1652-1 1652-2	<input type="text"/> 1653-1 1653-2

11.37.1 Alpha Description Programming: A Worksheet (Continued)

Zone 1

	Character 1	Character 2	Character 3	Character 4	Character 5	Character 6	Character 7	Character 8
Text	<input type="text"/>	<input type="text"/>	<input type="text"/>	<input type="text"/>	<input type="text"/>	<input type="text"/>	<input type="text"/>	<input type="text"/>
Value	<input type="text"/> 1654-1 1654-2	<input type="text"/> 1655-1 1655-2	<input type="text"/> 1656-1 1656-2	<input type="text"/> 1657-1 1657-2	<input type="text"/> 1658-1 1658-2	<input type="text"/> 1659-1 1659-2	<input type="text"/> 1660-1 1660-2	<input type="text"/> 1661-1 1661-2

	Character 9	Character 10	Character 11	Character 12	Character 13	Character 14	Character 15	Character 16
Text	<input type="text"/>	<input type="text"/>	<input type="text"/>	<input type="text"/>	<input type="text"/>	<input type="text"/>	<input type="text"/>	<input type="text"/>
Value	<input type="text"/> 1662-1 1662-2	<input type="text"/> 1663-1 1663-2	<input type="text"/> 1664-1 1664-2	<input type="text"/> 1665-1 1665-2	<input type="text"/> 1666-1 1666-2	<input type="text"/> 1667-1 1667-2	<input type="text"/> 1668-1 1668-2	<input type="text"/> 1669-1 1669-2

Zone 2

	Character 1	Character 2	Character 3	Character 4	Character 5	Character 6	Character 7	Character 8
Text	<input type="text"/>	<input type="text"/>	<input type="text"/>	<input type="text"/>	<input type="text"/>	<input type="text"/>	<input type="text"/>	<input type="text"/>
Value	<input type="text"/> 1670-1 1670-2	<input type="text"/> 1671-1 1671-2	<input type="text"/> 1672-1 1672-2	<input type="text"/> 1673-1 1673-2	<input type="text"/> 1674-1 1674-2	<input type="text"/> 1675-1 1675-2	<input type="text"/> 1676-1 1676-2	<input type="text"/> 1677-1 1677-2

	Character 9	Character 10	Character 11	Character 12	Character 13	Character 14	Character 15	Character 16
Text	<input type="text"/>	<input type="text"/>	<input type="text"/>	<input type="text"/>	<input type="text"/>	<input type="text"/>	<input type="text"/>	<input type="text"/>
Value	<input type="text"/> 1678-1 1678-2	<input type="text"/> 1679-1 1679-2	<input type="text"/> 1680-1 1680-2	<input type="text"/> 1681-1 1681-2	<input type="text"/> 1682-1 1682-2	<input type="text"/> 1683-1 1683-2	<input type="text"/> 1684-1 1684-2	<input type="text"/> 1685-1 1685-2

Zone 3

	Character 1	Character 2	Character 3	Character 4	Character 5	Character 6	Character 7	Character 8
Text	<input type="text"/>	<input type="text"/>	<input type="text"/>	<input type="text"/>	<input type="text"/>	<input type="text"/>	<input type="text"/>	<input type="text"/>
Value	<input type="text"/> 1686-1 1686-2	<input type="text"/> 1687-1 1687-2	<input type="text"/> 1688-1 1688-2	<input type="text"/> 1689-1 1689-2	<input type="text"/> 1690-1 1690-2	<input type="text"/> 1691-1 1691-2	<input type="text"/> 1692-1 1692-2	<input type="text"/> 1693-1 1693-2

	Character 9	Character 10	Character 11	Character 12	Character 13	Character 14	Character 15	Character 16
Text	<input type="text"/>	<input type="text"/>	<input type="text"/>	<input type="text"/>	<input type="text"/>	<input type="text"/>	<input type="text"/>	<input type="text"/>
Value	<input type="text"/> 1694-1 1694-2	<input type="text"/> 1695-1 1695-2	<input type="text"/> 1696-1 1696-2	<input type="text"/> 1697-1 1697-2	<input type="text"/> 1698-1 1698-2	<input type="text"/> 1699-1 1699-2	<input type="text"/> 1700-1 1700-2	<input type="text"/> 1701-1 1701-2

Zone 4

	Character 1	Character 2	Character 3	Character 4	Character 5	Character 6	Character 7	Character 8
Text	<input type="text"/>	<input type="text"/>	<input type="text"/>	<input type="text"/>	<input type="text"/>	<input type="text"/>	<input type="text"/>	<input type="text"/>
Value	<input type="text"/> 1702-1 1702-2	<input type="text"/> 1703-1 1703-2	<input type="text"/> 1704-1 1704-2	<input type="text"/> 1705-1 1705-2	<input type="text"/> 1706-1 1706-2	<input type="text"/> 1707-1 1707-2	<input type="text"/> 1708-1 1708-2	<input type="text"/> 1709-1 1709-2

	Character 9	Character 10	Character 11	Character 12	Character 13	Character 14	Character 15	Character 16
Text	<input type="text"/>	<input type="text"/>	<input type="text"/>	<input type="text"/>	<input type="text"/>	<input type="text"/>	<input type="text"/>	<input type="text"/>
Value	<input type="text"/> 1710-1 1710-2	<input type="text"/> 1711-1 1711-2	<input type="text"/> 1712-1 1712-2	<input type="text"/> 1713-1 1713-2	<input type="text"/> 1714-1 1714-2	<input type="text"/> 1715-1 1715-2	<input type="text"/> 1716-1 1716-2	<input type="text"/> 1717-1 1717-2

11.37.1 Alpha Description Programming: A Worksheet (Continued)

Zone 5

	Character 1	Character 2	Character 3	Character 4	Character 5	Character 6	Character 7	Character 8
Text	<input type="text"/>	<input type="text"/>	<input type="text"/>	<input type="text"/>	<input type="text"/>	<input type="text"/>	<input type="text"/>	<input type="text"/>
Value	<input type="text"/> 1718-1 1718-2	<input type="text"/> 1719-1 1719-2	<input type="text"/> 1720-1 1720-2	<input type="text"/> 1721-1 1721-2	<input type="text"/> 1722-1 1722-2	<input type="text"/> 1723-1 1723-2	<input type="text"/> 1724-1 1724-2	<input type="text"/> 1725-1 1725-2
	Character 9	Character 10	Character 11	Character 12	Character 13	Character 14	Character 15	Character 16
Text	<input type="text"/>	<input type="text"/>	<input type="text"/>	<input type="text"/>	<input type="text"/>	<input type="text"/>	<input type="text"/>	<input type="text"/>
Value	<input type="text"/> 1726-1 1726-2	<input type="text"/> 1727-1 1727-2	<input type="text"/> 1728-1 1728-2	<input type="text"/> 1729-1 1729-2	<input type="text"/> 1730-1 1730-2	<input type="text"/> 1731-1 1731-2	<input type="text"/> 1732-1 1732-2	<input type="text"/> 1733-1 1733-2

Zone 6

	Character 1	Character 2	Character 3	Character 4	Character 5	Character 6	Character 7	Character 8
Text	<input type="text"/>	<input type="text"/>	<input type="text"/>	<input type="text"/>	<input type="text"/>	<input type="text"/>	<input type="text"/>	<input type="text"/>
Value	<input type="text"/> 1734-1 1734-2	<input type="text"/> 1735-1 1735-2	<input type="text"/> 1736-1 1736-2	<input type="text"/> 1737-1 1737-2	<input type="text"/> 1738-1 1738-2	<input type="text"/> 1739-1 1739-2	<input type="text"/> 1740-1 1740-2	<input type="text"/> 1741-1 1741-2
	Character 9	Character 10	Character 11	Character 12	Character 13	Character 14	Character 15	Character 16
Text	<input type="text"/>	<input type="text"/>	<input type="text"/>	<input type="text"/>	<input type="text"/>	<input type="text"/>	<input type="text"/>	<input type="text"/>
Value	<input type="text"/> 1742-1 1742-2	<input type="text"/> 1743-1 1743-2	<input type="text"/> 1744-1 1744-2	<input type="text"/> 1745-1 1745-2	<input type="text"/> 1746-1 1746-2	<input type="text"/> 1747-1 1747-2	<input type="text"/> 1748-1 1748-2	<input type="text"/> 1749-1 1749-2

Zone 7

	Character 1	Character 2	Character 3	Character 4	Character 5	Character 6	Character 7	Character 8
Text	<input type="text"/>	<input type="text"/>	<input type="text"/>	<input type="text"/>	<input type="text"/>	<input type="text"/>	<input type="text"/>	<input type="text"/>
Value	<input type="text"/> 1750-1 1750-2	<input type="text"/> 1751-1 1751-2	<input type="text"/> 1752-1 1752-2	<input type="text"/> 1753-1 1753-2	<input type="text"/> 1754-1 1754-2	<input type="text"/> 1755-1 1755-2	<input type="text"/> 1756-1 1756-2	<input type="text"/> 1757-1 1757-2
	Character 9	Character 10	Character 11	Character 12	Character 13	Character 14	Character 15	Character 16
Text	<input type="text"/>	<input type="text"/>	<input type="text"/>	<input type="text"/>	<input type="text"/>	<input type="text"/>	<input type="text"/>	<input type="text"/>
Value	<input type="text"/> 1758-1 1758-2	<input type="text"/> 1759-1 1759-2	<input type="text"/> 1760-1 1760-2	<input type="text"/> 1761-1 1761-2	<input type="text"/> 1762-1 1762-2	<input type="text"/> 1763-1 1763-2	<input type="text"/> 1764-1 1764-2	<input type="text"/> 1765-1 1765-2

Zone 8

	Character 1	Character 2	Character 3	Character 4	Character 5	Character 6	Character 7	Character 8
Text	<input type="text"/>	<input type="text"/>	<input type="text"/>	<input type="text"/>	<input type="text"/>	<input type="text"/>	<input type="text"/>	<input type="text"/>
Value	<input type="text"/> 1766-1 1766-2	<input type="text"/> 1767-1 1767-2	<input type="text"/> 1768-1 1768-2	<input type="text"/> 1769-1 1769-2	<input type="text"/> 1770-1 1770-2	<input type="text"/> 1771-1 1771-2	<input type="text"/> 1772-1 1772-2	<input type="text"/> 1773-1 1773-2
	Character 9	Character 10	Character 11	Character 12	Character 13	Character 14	Character 15	Character 16
Text	<input type="text"/>	<input type="text"/>	<input type="text"/>	<input type="text"/>	<input type="text"/>	<input type="text"/>	<input type="text"/>	<input type="text"/>
Value	<input type="text"/> 1774-1 1774-2	<input type="text"/> 1775-1 1775-2	<input type="text"/> 1776-1 1776-2	<input type="text"/> 1777-1 1777-2	<input type="text"/> 1778-1 1778-2	<input type="text"/> 1779-1 1779-2	<input type="text"/> 1780-1 1780-2	<input type="text"/> 1781-1 1781-2

11.38 Phone Number Programming: Program Addresses (4028, 4038, 4048)

Example: To program Phone Number 1 as 555-1212.
Data Digit 1 = [5], Data Digit 2 = [5], Data Digit 3 = [5], Data Digit 4 = [1], Data Digit 5 = [2], Data Digit 6 = [1], Data Digit 7 = [2]
Enter the Programmer's Mode: [9] [8] [7] [6] [#] [0] Enter the Program Address: [4] [0] [2] [8] Enter Data Digit 1 = [5], Data Digit 2 = [5], Data Digit 3 = [5], Data Digit 4 = [1], Data Digit 5 = [2], Data Digit 6 = [1], Data Digit 7 = [2] Enter the pound key: [#] Program the next Address, Program a different Address, or Exit the Programmer's Mode.

11.38.1 Phone Number 1 Programming: Program Address (4028)

1	2	3	4	5	6	7	8	9	10	11	12	13	14	15	16	17	18	19	20
<input type="text"/>	<input type="text"/>	<input type="text"/>	<input type="text"/>	<input type="text"/>	<input type="text"/>	<input type="text"/>	<input type="text"/>	<input type="text"/>	<input type="text"/>	<input type="text"/>	<input type="text"/>	<input type="text"/>	<input type="text"/>	<input type="text"/>	<input type="text"/>	<input type="text"/>	<input type="text"/>	<input type="text"/>	<input type="text"/>

11.38.2 Phone Number 2 Programming: Program Address (4038)

1	2	3	4	5	6	7	8	9	10	11	12	13	14	15	16	17	18	19	20
<input type="text"/>	<input type="text"/>	<input type="text"/>	<input type="text"/>	<input type="text"/>	<input type="text"/>	<input type="text"/>	<input type="text"/>	<input type="text"/>	<input type="text"/>	<input type="text"/>	<input type="text"/>	<input type="text"/>	<input type="text"/>	<input type="text"/>	<input type="text"/>	<input type="text"/>	<input type="text"/>	<input type="text"/>	<input type="text"/>

11.38.3 Phone Number 3 (Remote Programmer) Programming: Program Address (4048)

1	2	3	4	5	6	7	8	9	10	11	12	13	14	15	16	17	18	19	20
<input type="text"/>	<input type="text"/>	<input type="text"/>	<input type="text"/>	<input type="text"/>	<input type="text"/>	<input type="text"/>	<input type="text"/>	<input type="text"/>	<input type="text"/>	<input type="text"/>	<input type="text"/>	<input type="text"/>	<input type="text"/>	<input type="text"/>	<input type="text"/>	<input type="text"/>	<input type="text"/>	<input type="text"/>	<input type="text"/>

Notes:

To dial the "*" character, enter *1 (The "*" character is sent as "1" "1" when pulse dialing).

To dial the "#" character, enter *2 (The "#" character is only valid when tone dialing).

To input a three second delay, enter *3.

To wait for the dial tone, enter *4 in the first digit.

To disable a Phone Number, enter *5 in the first digit.

(*1 - *5 are Hex values. They will display as B - F at the keypads.)

Recommendation: The phone line that the control panel is connected to should not have a Call Waiting feature. If it must have call waiting, program the code to disable call waiting and add a three second delay before the phone number. This will prevent incoming calls from interrupting a communication. For example: call waiting can be disabled in many areas by dialing *70 before the phone number for tone dial and 1170 for pulse dial.

11.39 Pager Delay Time: Program Address (3914)

When using the Pager Dialing Format (selected in Addresses 0529 and 0530), you may insert a delay time after the phone number is dialed and before the reports are sent to the pager system. This delay can be used to allow for greeting and instruction messages in the pager system. This delay will not affect any other report formats.

	Data Digit 1	Data Digit 2	
	<input type="text"/>	<input type="text"/>	
Pager Delay Time	↑ ↑		
Address 3914			
0 to 99 seconds			Default = 00 sec.

Note: Cannot be used for UL Listed Fire Applications.

12.0 Installation Guide for U.L. Listed Systems

12.1 DS7400Xi U. L. Listings:

- Household Fire Alarm, U. L. Standard UL985
- Commercial Fire Alarm (Type Service: Local, Central Station, Remote Station; Type Initiating: Automatic, Manual, Sprinkler Supervisory, and Waterflow), U. L. Standard UL864
- Household Burglary Alarm, U. L. Standard UL1023
- Police Station Connection Grades AA and A, U. L. Standard UL365
- Central Station Burglary Alarm Grades AA, A, B, and C; U. L. Standard UL1610
- Proprietary Alarm Units Grades A and AA, U. L. Standard UL1076

The control panel should be installed in accordance with U. L. Standard UL681, Installation and Classification of Mercantile and Bank Burglar Alarm Systems, or U. L. Standard UL1641, Installation and Classification of Residential Burglar Alarm Systems. It should also be installed in accordance with NFPA 72 for Household and Commercial Fire installations.

12.1.1 U.L System Configurations

The following table shows the DS7400Xi system configuration for the various types of fire and burglar alarm service for which the product is U. L. Listed.

Product	UL Application										
	CSF-D	CSF-D/RF	LF	CSB-A	PP-AA	CSB-B/C	PP-A	LB-A	PSCB-D-A	PSCB-RF-A	HF/B
DS7400Xi	R	R	R	R	R	R	R	R	R	R	R
Standard Enclosure	1	1	1	n/a	n/a	n/a	n/a	n/a	n/a	n/a	1
Attack Enclosure	1	1	1	R	R	R	R	R	R	R	1
AE-TR16 Enclosure	R	R	R	n/a	n/a	n/a	n/a	n/a	n/a	n/a	n/a
DS7416i	n/a	R	n/a	R	R	n/a	n/a	n/a	n/a	R	n/a
DS7420i	R	4	R	4	4	n/a	n/a	n/a	n/a	4	n/a
DS7430	0	0	0	0	0	0	0	0	0	0	0
DS7432	0	0	0	0	0	0	0	0	0	0	0
DS7433	0	0	0	0	0	0	0	0	0	0	0
DS7447/DS7447E	2	2	2	3	3	3	3	3	3	3	3
DS7460	0	0	0	0	0	0	0	0	0	0	0
DS7480	n/a	n/a	n/a	n/a	n/a	n/a	n/a	n/a	n/a	n/a	R
DS7481	n/a	4	n/a	4	4	n/a	n/a	n/a	n/a	4	n/a
DS7488	0	0	0	0	0	0	0	0	0	0	0
AB12 Bell w/Housing	n/a	n/a	n/a	R	R	R	R	R	R	R	n/a

Key to Application Codes

CSF-D = Central Station Fire w/ DACT (Digital Alarm Communications Transmitter/dialer)
CSF-D/RF = Central Station Fire w/ DACT and Radio (DS7416i)
LF = Local Fire
CSB-A = Central Station Burglary, grades AA and A
PP-AA = Proprietary grade AA
CSB-B/C = Central Station Burglary, grades B and C
PP-A = Proprietary grade A
LB-A = Local Burglary, grade A
PSCB-D-A = Police Station Connected Burglary w/DACT, grade A
PSCB-RF-A = Police Station Connected Burglary w/Radio (DS7416i), grades AA and A
HF/B = Household (residential) Fire and Burglary

Configuration Codes

R = Required
0 = Optional
n/a = Not Applicable
1 = Standard or attack enclosure may be used.
2 = Either enclosure may be used. Device must be mounted to the enclosure cover, or within 20 ft. w/wiring in conduit.
3 = Either enclosure may be used.
4 = Either the DS7420i or the DS7481 must be used to monitor the phone line input to the control unit.

12.2 Installation Considerations

- Failure to install and program the control in accordance with the requirements in this section voids the listing mark of Underwriters Laboratories, Inc.
- The maximum standby battery capacity is 35 AH @ 12 VDC.
- The total nominal standby current must not exceed 1.5 A nor 2.5 A when in alarm.
- The control must be mounted indoors and within the protected area.
- Enclosure tamper switches (if used) must be connected to a 24-hour zone.
- Grounding must be in accordance with article 250 of the NEC (NFPA 70).
- At least one U. L. Listed keypad with zone display must be connected.
- Zones must be connected to U. L. Listed, compatible devices.

- 50 Hz. AC input cannot be used in U. L. Listed Requirements.
- The ground wire provided with the enclosure must be connected between the "Earth GND" connection on the control and the enclosure tab.
- The keypad panic alarm output must follow the corresponding zone function's programming (e.g. fire = pulsing [or steady if not a combination], burglary = steady). In all cases, the special emergency keys must be silent.
- The ground start feature shall not be programmed.

12.3 Programming the DS7400Xi

When used in U. L. Listed Requirements, the control must conform to certain programming requirements. The following is a list of the required program entries and required accessories for specific U. L. Listed Requirements.

12.3.1 Household Fire Alarm using Digital Alarm Communicator Transmitter with local bell

The control must be installed in accordance with NFPA 72.

Required Accessories:

- At least one Detection Systems, Inc. Model DS250 Series smoke detector with an MB Series base, DS280 Series, MX280 Series, or another Listed compatible smoke detector.
- At least one DS7480 Bell Supervision Module.
- One Wheelock 46T-G10-12 bell or 34T-12 horn (will provide 85dB for UL985 and NFPA 72 requirements; other Listed compatible devices with a voltage range of 10.2 to 14.0 V may be used) is required and must be installed inside the protected area.
- The standard control enclosure can be used.
- At least one DS7447/DS7447E or DS7445/DS7445i Keypad must be used.
- Four-wire detectors must be used with Listed power supervision devices. A compatible Listed 4-wire detector is the Detection Systems, Inc. DS250 in an MB4W base. A compatible Listed EOL relay is the Detection Systems, Inc. EOL200.
- All zones must be used with the EOL resistor (P/N 25899), provided.

1. Report Programming:

- Fire Zone Report must be programmed.
- Low Battery Report (Program Address 0325) must be programmed.
- AC Failure Report (Program Address 0327) must be programmed.

2. Timer Programming:

- Bell Cutoff Times (Program Addresses 0195 and 0196) must be programmed for not less than 4 minutes.

3. Zone Function Programming:

- For household fire installations only, the output signal may be pulsed or steady. For a combination system, see the selection below on alarm output programming.

4. Alarm Output Programming:

- Program Address 0146 must be programmed as: Data Digit 1=6, Data Digit 2=3.

5. General Control Programming:

- Program Address 0185 must be programmed as: Data Digit 1=0, Data Digit 2=0.

12.3.2 Grade A Household Burglary Alarm using Digital Alarm Communicator Transmitter with local bell

The control must be installed in accordance with U. L. Standard UL1641.

Required Accessories:

- At least one Wheelock 46T-G10-12 bell or 34T-12 horn (other Listed compatible devices with a voltage range of 10.2 to 14.0 V

- may be used) is required for this application.
- The standard DS7400 enclosure can be used.
- At least 1 DS7480 Bell Module

1. Report Programming:

- Burglar Zone Reports must be programmed for those zones used.
- Low Battery Report (Program Address 0325) must be programmed.
- AC Failure Report (Program Address 0327) must be programmed.

2. Timer Programming:

- Bell Cutoff Times (Program Addresses 0195 and 0196) must be programmed for not less than 4 minutes.
- Entry Delay Timer (Program Addresses 0191 and 0192) must be programmed for not longer than 60 seconds.
- Exit Delay Timer (Program Address 0193) must be programmed for not longer than 45 seconds.

3. General Control Programming:

- Program Address 0000, Data Digit 2 must be programmed for NO Swinger Shunts (enter 0, 1, or 2).
- Program Address 0185 must be programmed as: Data Digit 1=0, Data Digit 2=0.

4. Alarm Output Programming:

- Program Address 0146 must be programmed as: Data Digit 1=6, Data Digit 2=3.
- Program Address 0149 must be programmed as: Data Digit 1=8.

NOTE In a system that includes both fire alarm and burglar alarm devices, the system must produce distinct sounds for fire and burglar alarm conditions either by using different indicating appliances or by using distinct cadences for the same appliance.

12.4 General System Requirements

Applies to the following grades only:

Local Burglary Alarm

Grade A using Digital Alarm Communicator Transmitter (DACT) Police Station Connection

Grades AA and A using DACT and ARDIS interface module.
Grade A using DACT and local Bell.

Central Station Burglary Alarm

Grades AA and A using DACT and ARDIS interface module.
Grade B using DACT and local bell.
Grade C using Digital Alarm Communicator Transmitter only.

The controls must be installed in accordance with U. L. Standards UL681 and UL609 for all grades of service.

1. Report Programming:

- Burglar Zone Reports must be programmed for those zones used.
- Low Battery Report (Program Address 0325) must be programmed.
- AC Failure Report (Program Address 0327) must be programmed.
- Open Report (Program Address 0320) must be programmed.
- Close Report (Program Address 0321) must be programmed.
- 24-Hour Check-In Reports (Program Addresses 0329 and 0336) must be programmed.

2. General Control Programming:

- The control must not be programmed for auto disarm.
- Must be programmed for no swinger shunts and closing ringback. (Program Address 0000 data digit 2, enter 0, 1, or 2).
- Program Address 0185 must be programmed as: Data Digit 1=0,

Data Digit 2=0.

3. Zone Function Programming:

- The Burglar alarm signal (whether pulsed or steady) must be different from the Fire alarm signal.

4. Alarm Output Programming:

- Program Address 0146 must be programmed as: Data Digit 1=6, Data Digit 2=3.
- Program Address 0149 must be programmed as: Data Digit 1=8.

12.4.1 Local Burglary Alarm

A. Grade A Installations using Digital Alarm Communicator Transmitter with local bell

Follow General System Requirements as listed in 12.4.

Required Accessories:

- The control must be in the Detection System's model AE3CC enclosure with a cover actuated tamper switch installed.
- An Ademco Model AB-12 bell/housing (see section 12.6).

1. Timer Programming:

- Bell Cutoff Times (Program Addresses 0195 and 0196) must be programmed for not less than 15 minutes.
- Entry, Exit Delay Times (Program Addresses 0191-0193) must be programmed for not longer than 60 seconds.

12.4.2 Police Station Connection

Follow General System Requirements as listed in 12.4.

Required Accessories:

- The control must be in the Detection Systems' model AE3CC enclosure with a cover actuated tamper switch installed.
- An ARDIS (or DataTAC) interface module.
- The ARDIS module and antenna should be mounted within the protected area.
- The Detection Systems' model DS7481 Phone Line Monitor.

1. Timer Programming:

- Entry, Exit Delay Times (Program Addresses 0191-0193) must be programmed for not longer than 60 seconds.

B. Grade A Installations using Digital Alarm Communicator Transmitter with local bell

Follow General System Requirements as listed in 12.4.

Required Accessories:

- The control must be in the Detection System's model AE3CC enclosure with a cover actuated tamper switch installed.
- The Ademco Model AB-12 bell/housing (see section 12.6).

1. Timer Programming:

- Bell Cutoff Times (Program Addresses 0195 and 0196) must be programmed for not less than 15 minutes.
- Entry, Exit Delay Times (Program Addresses 0191-0193) must be programmed for not longer than 60 seconds.

12.4.3 Central Station Burglary Alarm and Proprietary

A. Central Station Burglary Grades AA and A and Proprietary Grade AA Installations using an ARDIS Interface Module

Follow General System Requirements as listed in 12.4.

Required Accessories:

- The control must be in the Detection Systems' model AE3CC enclosure with a cover actuated tamper switch installed.
- An ARDIS (or DataTAC) interface module.
- The ARDIS module and antenna should be mounted within the protected area.
- The Detection Systems' model DS7481 Phone Line Monitor.

- The Ademco Model AB-12 bell/housing (see section 12.6).

1. Timer Programming:

- Entry, Exit Delay Times (Program Addresses 0191-0193) must be programmed for not longer than 60 seconds.

B. Grade B Installations using Digital Alarm Communicator Transmitter with local bell

Follow General System Requirements as listed in 12.4.

Required Accessories:

- The control must be in the Detection Systems' model AE3CC enclosure with a cover actuated tamper switch installed.
- The Ademco Model AB-12 bell/housing (see section 12.6).

1. Timer Programming:

- Bell Cutoff Times (Program Addresses 0195 and 0196) must be programmed for not less than 15 minutes.
- Entry, Exit Delay Times (Program Addresses 0191-0193) must be programmed for not longer than 60 seconds.

C. Central Station Burglary Grade C and Proprietary Grade A Installations using Digital Alarm Communicator Transmitter only

Follow General System Requirements as listed in 12.4.

Required Accessories:

- The control must be in the Detection System's model AE3CC enclosure with a cover actuated tamper switch installed.

1. Timer Programming:

- Entry, Exit Delay Times (Program Addresses 0191-0193) must be programmed for not longer than 60 seconds.

12.5 Commercial Fire Alarm

A. Central Station (DACT) and Local

The control must be installed in accordance with NFPA 72.

Required Accessories:

- DS7420i Dual Phone Line/Bell Supervision Module.
- For Local Commercial Fire Alarm: A Listed notification appliance such as a Wheelock 46T-G10-12 bell or 34T-12 horn.
- If not using the phone line supervision, it must be disabled.
- AE-TR16 Transformer Housing.
- At least one DS7447/DS7447E must be used and assigned as keypad 1. If only one is used, it may be connected to the keypad bus if the keypad is mounted to the front of the box or within the same room as the control equipment and the wire is run in conduit (or equivalently protected against mechanical injury) within 20 ft. (6.1 m) of the control equipment. If multiple keypads are used, one keypad only must be used on the options bus and assigned as keypad 11-14 and meet the same requirements as in single keypad use.
- 50 Hz. operation and ground start are automatically forced to the disabled state when central station fire mode is selected.

1. Report Programming:

- Burglar Zone Reports must be programmed for those zones used.
- Fire Zone Reports must be programmed for those zones used.
- Low Battery Report (Program Address 0325) must be programmed.
- AC Failure Report (Program Address 0327) must be programmed.
- Open Report (Program Address 0320) must be programmed.
- Close Report (Program Address 0321) must be programmed.
- 24-Hour Check-In Reports (Program Addresses 0329 and 0336) must be programmed.

2. Timer Programming:

- Bell Cutoff Times (Program Addresses 0195 and 0196) must be programmed for not less than 5 minutes.
- Entry, Exit Delay Times (Program Addresses 0191-0193) must

be programmed for not longer than 60 seconds.

3. General Control Programming:

- Must be programmed for no swinger shunts (Program Address 0000 data digit 2, enter 0, 1, or 2).
- Program Address 0185 must be programmed as: Data Digit 1=0, Data Digit 2=0.

4. Commercial Fire Mode Programming:

- Local (Program Address 0186, data digit 1, enter as a 1 through 6).
- Central Station (Program Address 0186, data digit 1, enter as a 7 through *2).
- The keypad panic functions are not intended to be a substitute for Listed manual pull boxes.

12.6 Wiring and Programming Information for Installations Using the Ademco AB-12 Bell/Housing

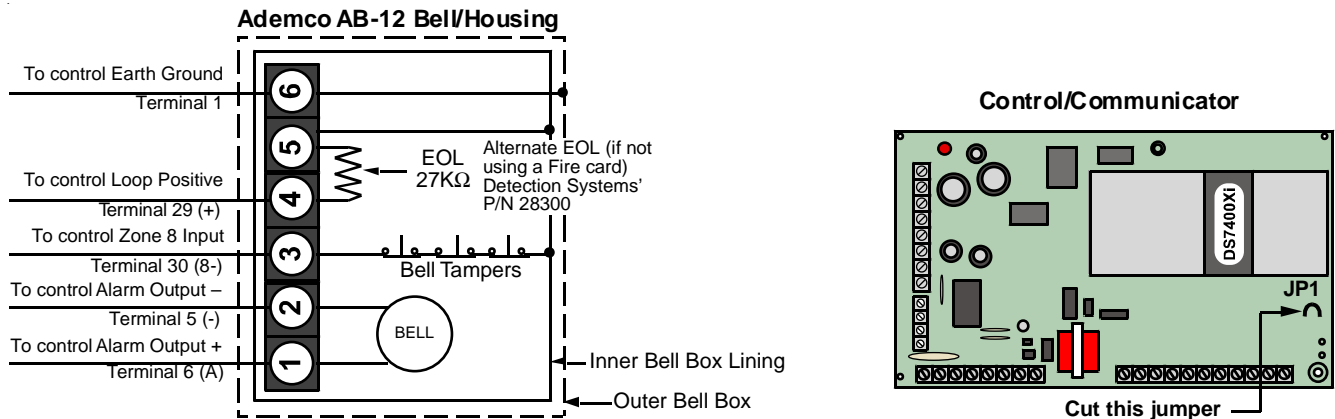

- 1) Disconnect the wire jumper from terminal 4 to the inner housing of the Bell Box (prevents a ground fault condition).
- 2) Connect wiring between the control and Bell Box as shown above. To use the AB-12 Bell/Housing, cut the jumper wire "JP1" on the control. The EOL used in the AB-12 Bell/Housing must be 27K ohms.
- 3) Program Zone 8 as a 24-hour zone by programming it to follow zone function 7. (Program address 0025 = 07).
- 4) Do not change the default programming of zone function 7. (Program address 0007 should be 22).

13.0 Report Programming

13.1 4/2 Format

Suggested Values

	Report			Restoral			Trouble			Trouble Restoral			Bypass			Bypass Restoral		
	Address	Value		Address	Value		Address	Value		Address	Value		Address	Value		Address	Value	
Zone Function 1	0258	A	1	0275	2	1	0290	6	1	0305	4	1	0347	8	1	0362	9	1
Zone Function 2	0259	A	2	0276	2	2	0291	6	2	0306	4	2	0348	8	2	0363	9	2
Zone Function 3	0260	A	3	0277	2	3	0292	6	3	0307	4	3	0349	8	3	0364	9	3
Zone Function 4	0261	A	4	0278	2	4	0293	6	4	0308	4	4	0350	8	4	0365	9	4
Zone Function 5	0262	A	5	0279	2	5	0294	6	5	0309	4	5	0351	8	5	0366	9	5
Zone Function 6	0263	A	6	0280	2	6	0295	6	6	0310	4	6	0352	8	6	0367	9	6
Zone Function 7	0264	A	7	0281	2	7	0296	6	7	0311	4	7	0353	8	7	0368	9	7
Zone Function 8	0265	A	8	0282	2	8	0297	6	8	0312	4	8	0354	8	8	0369	9	8
Zone Function 9	0266	A	9	0283	2	9	0298	6	9	0313	4	9	0355	8	9	0370	9	9
Zone Function 10	0267	A	A	0284	2	A	0299	6	A	0314	4	A	0356	8	A	0371	9	A
Zone Function 11	0268	A	B	0285	2	B	0300	6	B	0315	4	B	0357	8	B	0372	9	B
Zone Function 12	0269	A	C	0286	2	C	0301	6	C	0316	4	C	0358	8	C	0373	9	C
Zone Function 13	0270	A	D	0287	2	D	0302	6	D	0317	4	D	0359	8	D	0374	9	D
Zone Function 14	0271	A	E	0288	2	E	0303	6	E	0318	4	E	0360	8	E	0375	9	E
Zone Function 15	0272	A	F	0289	2	F	0304	6	F	0319	4	F	0361	8	F	0376	9	F

Reports with Restorals

	Report			Restoral		
	Address	Value		Address	Value	
Low Battery	0325	3	1	0326	7	1
AC Fail	0327	3	2	0328	7	2
System Trouble	0334	3	3	0335	7	3
Keypad Fire	0256	3	4	0257	7	4
System Test	0339	3	5	0340	7	5

Reports without Restorals

	Address	Value	
Open	0320	5	1
Close	0321	5	2
Partial Close	0322	5	3
First Open after Alarm	0324	5	4
Exit Error	0337	5	5
Recent Closing	0338	5	6
Keypad Emergency	0273	5	7
Keypad Panic	0274	5	8
Duress	0322	5	9

	Report Successful			Report Unsuccessful		
	Address	Value		Address	Value	
Remote Program	0330	E	F	0331	F	F
Local Program	0332	E	F	0333	F	F

13.2 BFSK Format

Suggested Values

Reports with Restorals

	Report			Restoral			Trouble			Trouble Restoral			Bypass			Bypass Restoral		
	Address	Value		Address	Value		Address	Value		Address	Value		Address	Value		Address	Value	
Zone Function 1	0258	1	0	0275	E	1	0290	F	1	0305			0347			0362		
Zone Function 2	0259	2	0	0276	E	2	0291	F	2	0306			0348			0363		
Zone Function 3	0260	3	0	0277	E	3	0292	F	3	0307			0349			0364		
Zone Function 4	0261	4	0	0278	E	4	0293	F	4	0308			0350			0365		
Zone Function 5	0262	5	0	0279	E	5	0294	F	5	0309			0351			0366		
Zone Function 6	0263	6	0	0280	E	6	0295	F	6	0310			0352			0367		
Zone Function 7	0264	7	0	0281	E	7	0296	F	7	0311			0353			0368		
Zone Function 8	0265	8	0	0282	E	8	0297	F	8	0312			0354			0369		
Zone Function 9	0266	8	0	0283	E	8	0298	F	0	0313			0355			0370		
Zone Function 10	0267	8	0	0284	E	8	0299	F	0	0314			0356			0371		
Zone Function 11	0268	8	0	0285	E	8	0300	F	0	0315			0357			0372		
Zone Function 12	0269	8	0	0286	E	8	0301	F	0	0316			0358			0373		
Zone Function 13	0270	8	0	0287	E	8	0302	F	0	0317			0359			0374		
Zone Function 14	0271	8	0	0288	E	8	0303	F	0	0318			0360			0375		
Zone Function 15	0272	8	0	0289	E	8	0304	F	0	0319			0361			0376		

Reports with Restorals

	Report			Restoral		
	Address	Value		Address	Value	
Low Battery	0325	F	9	0326		
AC Fail	0327	F	A	0328	E	A
System Trouble	0334	F	D	0335	E	D
Keypad Fire	0256	1	0	0257	E	1
System Test	0339	7	1	0340	7	2

Reports without Restorals

	Address	Value	
Open	0320	B	F
Close	0321	C	F
Partial Close	0322	A	0
First Open after Alarm	0324	D	F
Exit Error	0337		
Recent Closing	0338		
Keypad Emergency	0273	0	0
Keypad Panic	0274	9	0
Duress	0322	A	0

	Report Successful			Report Unsuccessful		
	Address	Value		Address	Value	
Remote Program	0330	0	0	0331	0	0
Local Program	0332	0	0	0333	0	0

13.3 Personal Dialing and Pager Format

This is a 2 pulse per second (PPS) 0/2 (no account code/2 report event digits) format intended for manual reception, i.e. the panel will call a phone number where a person is expected to answer. After a call is made, the panel will start sending the first report. If the report was a "Communication Test" and Program Address 0329 had a value of 12 the person answering the phone would hear 1 pulse followed by a 1 second delay, then 2 pulses followed by a 3 second delay. This sequence will repeat for 60 seconds per call. After the 60 seconds the panel will hang up and call again if any reports still remain to be sent.

A way to expedite this report process would be to provide an acknowledge to the panel that the report was heard and understood by the receiving party. When an acknowledge is provided, the panel will start sending the next report or hang up if no reports remain. To provide an acknowledge, press and hold the 1 key of the telephone keypad for 2 seconds during the 3 second delay of the report transmission. This "Acknowledge Feature" is an enhancement that will allow the panel to send all reports in one call. If the call is not acknowledged a communication failure is sent after all dial attempts are made.

It is recommended that the reporting values for this format be the same as the Pager Format.

13.4 Pager Format

The Pager format allows the control panel to dial a digital pager and leave a numeric message which includes an account ID and report type. The telephone number is dialed when a report is available. At the completion of the telephone dialing, a fixed time delay equal to 10 seconds occurs. This delay allows time to connect with the pager service, while skipping over any voice announcement. When the delay has ended, the numeric message is sent. This message includes the account number followed by up to 5 reports. If a delay time greater than 10 seconds is required, increments of 3 seconds can be added by programming the "**3" character (3 second delay) at the end of the phone number in address 4028 or 4038.

For example, if you call pager number 123-4567 and it takes 20 seconds after you finished dialing before you are allowed to enter the message, the following digits should be programmed in address 4028: 1 2 3 4 5 6 7 *3 *3 *3 *3. This will give you an overall delay of 22 seconds.

NOTE For Pager format, it is not advisable to use the HEX character values (*0 = A, *1 = B, *2 = C, *3 = D, *4 = E, *5 = F) in the report programming addresses 0256 through 0340. These characters could cause unpredictable results when sent to a pager system that only expects numeric characters between 0-9. This is the reason that this format will not allow an associated user number with an open and close report.



Pager Format allows the use of the digit "0" as the reporting (first) digit. Using a "0" as the reporting digit will disable the reporting in all other formats.

The following are recommended programming values for addresses 0256 through 0340 when using the Pager format.

NOTE The Pager format is an open-loop format which has no acknowledge tone. There is no indication at the control panel that the signal has been sent. Therefore, the Pager format is not recommended as the primary communication method.

It cannot be used for UL Fire Applications.



Refer to the worksheet on the next page for Reports with Restorals. The values for each report can be determined by the user in conjunction with the installer. Again, the digit "0" (zero) should **not be used as the reporting (first) digit as it will affect other reports in the system. Examples have been provided for possible reporting values, but the values can be set to the user's preferences.**

Pager Format (Continued)

Reports with Restorals

	Report		Restoral		Trouble		Trouble Restoral		Bypass		Bypass Restoral	
	Address	Value	Address	Value	Address	Value	Address	Value	Address	Value	Address	Value
EXAMPLE:	0258	1 1	0275	2 1	0290	4 1	0305	1 6	0347	6 4	0362	9 9
Zone Function 1	0258		0275		0290		0305		0347		0362	
Zone Function 2	0259		0276		0291		0306		0348		0363	
Zone Function 3	0260		0277		0292		0307		0349		0364	
Zone Function 4	0261		0278		0293		0308		0350		0365	
Zone Function 5	0262		0279		0294		0309		0351		0366	
Zone Function 6	0263		0280		0295		0310		0352		0367	
Zone Function 7	0264		0281		0296		0311		0353		0368	
Zone Function 8	0265		0282		0297		0312		0354		0369	
Zone Function 9	0266		0283		0298		0313		0355		0370	
Zone Function 10	0267		0284		0299		0314		0356		0371	
Zone Function 11	0268		0285		0300		0315		0357		0372	
Zone Function 12	0269		0286		0301		0316		0358		0373	
Zone Function 13	0270		0287		0302		0317		0359		0374	
Zone Function 14	0271		0288		0303		0318		0360		0375	
Zone Function 15	0272		0289		0304		0319		0361		0376	

Reports with Restorals

	Report		Restoral	
	Address	Value	Address	Value
Low Battery	0325	6 0	0326	7 0
AC Fail	0327	6 1	0328	7 1
System Trouble	0334	6 2	0335	7 2
Keypad Fire	0256	9 0	0257	9 1
System Test	0339	6 5	0340	7 5

Reports without Restorals

	Address	Value
Open	0320	8 0
Close	0321	8 1
Partial Close	0322	8 2
First Open after Alarm	0324	8 3
Exit Error	0337	8 6
Recent Closing	0338	8 7
Keypad Emergency	0273	9 2
Keypad Panic	0274	9 3
Duress	0322	9 4

	Report Successful		Report Unsuccessful	
	Address	Value	Address	Value
Remote Program	0330	E F	0331	F F
Local Program	0332	E F	0333	F F

14.0 Report Programming - Values Sent

14.1 SIA Formats

Extended SIA Codes

Data Digit 2 value	SIA Report	Explanation
1	PA	Panic Alarm
2	PR	Panic Restore
3	QA	Emergency Alarm
4	QR	Emergency Restore
5	TA	Tamper Alarm
6	TR	Tamper Restore
7	UA	Untyped Zone Alarm
8	UR	Untyped Zone Restore
9	UT	Untyped Zone Trouble
*0	UJ	Untyped Trouble Restore
*1	YP	Power Supply Trouble
*2	YQ	Power Supply Restore
*3	YX	Service Required

Reports	SIA event code	SIA data field
Burglary alarm for a zone	B A	Zone Number
Fire alarm for a zone	F A	Zone Number
Waterflow alarm for a zone	S A	Zone Number
Supervisory for a zone	S S	Zone Number
Keypad fire (A)	F A	000
Keypad fire restoral (A)	F R	000
Keypad emergency (1, 3, or B)	Q A	None
Keypad panic (*, #, or C)	P A	None
Burglary restoral for a zone	B R	Zone Number
Fire restoral for a zone	F R	Zone Number
Waterflow restoral for a zone	S R	Zone Number
Supervisory restoral for a zone	S J	Zone Number
Burglary trouble for a zone	B T	Zone Number
Burglary trouble restoral	B J	Zone Number
Fire trouble for a zone	F T	Zone Number
Fire trouble restoral	F J	Zone Number
Waterflow trouble for a zone	F T	Zone Number
Supervisory trouble for a zone	F T	Zone Number
Burglary Zone Bypass	B B	Zone Number
Burglary Zone Bypass restoral	B U	Zone Number
24 Hour Zone Bypass	B B	Zone Number
24 Hour Zone Bypass restoral	B U	Zone Number
Keypad Tamper	E X	None
Keypad Tamper restoral	E R	None
Tamper RF zone	T T	Zone Number
Tamper, Alarm RF zone	B A	Zone Number
Tamper restoral RF zone	B J	Zone Number
Low Battery RF zone	X T	Zone Number
Low Battery restoral RF zone	B J	Zone Number
Loss of Supervision RF	T T	Zone Number
Open report	O P	User Number
Close report	C L	User Number
Duress report	H A	000
Partial close report	C G	User Number
First open after alarm (cancel) report	O R	None
Low battery	Y T	None
Low battery restoral	Y R	None
AC failure	A T	None
AC failure restoral	A R	None
Octal relay fault report	E T	None
Octal relay restoral	E R	None
Exit error report	E E	None
Recent closing report	C R	None
System walk test start report	T S	None
System walk test end report	T E	None

Continued on next page

14.1 SIA Formats (Continued)

Reports	SIA event code		SIA data field
Fire walk test report	F	I	None
Fire walk test restoral	F	K	None
Dirty Smoke Chamber report	M	C	Zone Number
Dirty Smoke Chamber restoral	M	O	Zone Number
Mux. Smoke low temperature report	M	F	Zone Number
Mux Smoke low temperature restoral	M	R	Zone Number
Automatic system normal test report	R	P	None
Manual communicator test report	R	X	None
Remote programming successful report	R	S	None
Remote programming failure report	R	U	None
Local programming successful report	Y	G	None
Local programming failure report	Y	F	None
Communication failure report	Y	C	None
Communication restoral	Y	K	None
EEPROM checksum failure or keypad supervision failure report	E	T	None
EEPROM checksum restoral or keypad supervision restoral	E	R	None
Multiplex bus fault	E	T	None
Multiplex bus restoral	E	R	None
Radio receiver tamper	X	S	Receiver Number
Radio receiver tamper restoral	X	J	Receiver Number
Radio receiver jammed	X	Q	Receiver Number
Radio receiver jammed restoral	X	H	Receiver Number
Radio receiver trouble report	X	Q	Receiver Number
Radio receiver trouble restoral	X	H	Receiver Number
Aux. power fault report	Y	P	None
Aux. power restoral	Y	Q	None
Ground fault report	U	T	None
Ground fault restoral	U	J	None
Automatic system off normal test report	R	P	None
Phone line 1 fault report	L	T	None
Phone line 1 restoral	L	R	None
Phone line 2 fault report	L	T	None
Phone line 2 restoral	L	R	None
ARDIS fault report	Y	S	See 8.13.6 Error Displays
ARDIS fault restoral	Y	K	See 8.13.6 Error Displays
Bell fault report	E	T	None
Bell restoral	E	R	None
RAM fault report	E	T	None
RAM restoral	E	R	None
ROM fault report	E	T	None
ROM restoral	E	R	None
Serial interface fault report	V	T	None
Serial interface restoral	V	R	None
Aux. relay fault report	E	T	None
Aux. relay restoral	E	R	None

14.2 CID Formats

Reports	CID event code	CID data field	Reports	CID event code	CID data field
Burglary alarm for a zone	130	Zone Number	Fire walk test report	604	None
Fire alarm for a zone	110	Zone Number	Fire walk test restoral	604 Restoral	None
Waterflow alarm for a zone	113	Zone Number	Dirty Smoke Chamber report	385	Zone Number
Supervisory for a zone	200	Zone Number	Dirty Smoke Chamber restoral	385 Restoral	Zone Number
Keypad fire (A)	110	000	Mux. Smoke low temperature report	159	Zone Number
Keypad fire restoral (A)	110 Restoral	000	Mux Smoke low temperature restoral	159 Restoral	Zone Number
Keypad emergency (1, 3, or B)	122	None	Automatic system normal test report	602	None
Keypad panic (*, #, or C)	123	None	Manual communicator test report	601	None
Burglary restoral for a zone	130 Restoral	Zone Number	Remote programming successful report	412	None
Fire restoral for a zone	110 Restoral	Zone Number	Remote programming failure report	413	None
Waterflow restoral for a zone	113 Restoral	Zone Number	Local programming successful report	306	None
Supervisory restoral for a zone	200 Restoral	Zone Number	Local programming failure report	306 Restoral	None
Burglary trouble for a zone	370	Zone Number	Communication failure report	354	None
Burglary trouble restoral	370 Restoral	Zone Number	Communication restoral	354 Restoral	None
Fire trouble for a zone	373	Zone Number	EEPROM checksum or keypad supervision failure report	330	None
Fire trouble restoral	373 Restoral	Zone Number	EEPROM checksum or keypad supervision restoral	330 Restoral	None
Waterflow trouble for a zone	373	Zone Number	Multiplex bus fault	333	None
Supervisory trouble for a zone	373	Zone Number	Multiplex bus restoral	333 Restoral	None
Burglary Zone Bypass	573	Zone Number	Radio receiver tamper	341	Receiver Number
Burglary Zone Bypass restoral	573 Restoral	Zone Number	Radio receiver tamper restoral	341 Restoral	Receiver Number
24 Hour Zone Bypass	573	Zone Number	Radio receiver jammed	333	Receiver Number
24 Hour Zone Bypass restoral	573 Restoral	Zone Number	Radio receiver jammed restoral	333 Restoral	Receiver Number
Keypad Tamper	341	None	Radio receiver trouble report	333	Receiver Number
Keypad Tamper restoral	341 Restoral	None	Radio receiver trouble restoral	333 Restoral	Receiver Number
Tamper RF zone	383	Zone Number	Aux. power fault report	300	None
Tamper, Alarm RF zone	130	Zone Number	Aux. power restoral	300 Restoral	None
Tamper restoral RF zone	370 Restoral	Zone Number	Ground fault report	310	None
Low Battery RF zone	384	Zone Number	Ground fault restoral	310 Restoral	None
Low Battery restoral RF zone	370 Restoral	Zone Number	Automatic system off normal test report	602	None
Loss of Supervision RF	381	Zone Number	Phone line 1 fault report	351	None
Open report	401	User Number	Phone line 1 restoral	351 Restoral	None
Close report	401 Restoral	User Number	Phone line 2 fault report	352	None
Duress report	121	000	Phone line 2 restoral	352 Restoral	None
Partial close report	408 Restoral	User Number	ARDIS fault report	353	See 8.13.6 Error Displays
First open after alarm (cancel) report	406	None	ARDIS fault restoral	353 Restoral	See 8.13.6 Error Displays
Low battery	302	None	Bell fault report	321	None
Low battery restoral	302 Restoral	None	Bell restoral	321 Restoral	None
AC failure	301	None	RAM fault report	303	None
AC failure restoral	301 Restoral	None	RAM restoral	303 Restoral	None
Octal relay fault report	330	None	ROM fault report	304	None
Octal relay restoral	330 Restoral	None	ROM restoral	304 Restoral	None
Exit error report	134	None	Serial interface fault report	336	None
Recent closing report	405	None	Serial interface restoral	336 Restoral	None
System walk test start report	607	None	Aux. relay fault report	320	None
System walk test end report	607 Restoral	None	Aux. relay restoral	320 Restoral	None

15.0 Multiplex Zone Addressing Guide

- Before installing a multiplex device, its address and other information must be programmed into the control panel. (To disable or remove a multiplex point, set the program address for 00 [see Section 11.3].) Perform the following:
- Program the control panel.

- Refer to section 11.2-11.4, Zone Programming.

This section allows you to define the Multiplex Zone's address (zone number), its type (single or multiple zone input device, a DS7465, a Multiplex Smoke or a Multiplex Smoke with a Low Temperature Alarm), which zone or output function it will follow (1-15) and its partition (1-8).

For example: Program zone 9 to be a single zone input device (MX950) that follows zone function 1 and is in partition 1.

Procedure: Enter the programmer's mode.
Enter address 0026.
Enter the data digits as [0] and [1] followed by the [#] button.
Enter address 1252.
Enter the data digits as [0] and [0] followed by the [#] button.
Exit the programmer's mode.

- Program the BusLoc® feature.

At this point, you must decide whether or not to use the BusLoc® feature.

BusLoc® is a proprietary method of tying the multiplex zones to the control panel to prevent the system from being taken over. Using BusLoc® will program an invisible identification code into the multiplex zones.

NOTE If using the DS7432 8-Input Remote Module or the DS7433 8-Input Direct Module, the BusLoc® feature can not be used.

- If you choose to use the BusLoc® feature, program a 5 digit code at programming address 9999.

It is very important to save this code under lock and key. If you need to replace the control panel, you will have to program it with the same BusLoc® code as the previous panel or the multiplex devices will not match codes with the new control panel.

For example: Program the BusLoc® code to be 54321.

Procedure: Enter the programmer's mode.
Enter address 9999.
Enter the data digits as [5], [4], [3], [2], and [1] followed by the [#] button.
Exit the programmer's mode.

- Once the pre-programming is done, you are ready to program the multiplex devices. Perform the following:

- Disconnect all multiplex devices from the DS7430.

- Program the multiplex devices through the control panel. Perform the following:

- Enter the programmer's mode.
- Enter the multiplex programming mode.
Do this by entering [9] [9] [9] [5] followed by the [#] button.
- The control will then take a few seconds to check the multiplex connection to confirm nothing is connected to it. The display will show the following:

**Checking
Multiplex Bus**

- The display will then call-up the first zone you have pre-programmed to be a multiplex zone. To access a different zone, press the [Reset/*] key, then enter the three digit value of the zone you want. The display will show the following:

**Sens/Contact 009
Press # to Prog**

Before you do anything else, reconnect the multiplex device (that coincides with the displayed zone) to the multiplex bus of the DS7430.

For DS7465s and Multiple Input devices, pressing the [#] button now will program these devices to the control panel. Remember, these devices take up two addresses. When address 009 (for example) is a DS7465, pressing the [#] button now will program both addresses 009 and 010.

For Single Input devices, press the [#] button to continue programming. The display asks whether you are programming a sensor or a contact; it will show the following:

**Sensor? Press 4
Contact? Press 6**

If you are programming a sensor, press the [4] button to program these devices to the control panel. If you are programming a contact, press the [6] button to program these devices to the control panel.

- If the device is successfully programmed, the keypad will sound a single beep and increment to the next zone (if there is one) pre-programmed as a multiplex zone.



Disconnect the device you just programmed and connect the next device (that belongs to the displayed zone) to the multiplex bus of the DS7430 and press the [#] button. Continue programming.



24-hour zones will alarm when you exit the programmer's mode. Alarm reports for these zones will be sent if they have been programmed. If you do not want these reports sent, disconnect power from the system now by unplugging the transformer and removing the red battery lead. Do not reconnect power until all zones have been installed and connected to the multiplex bus.

- If no other zones have been pre-programmed, the display will show the following:

**Mux Zone
Enter Zone**

- You may now exit the Zone Programmer's mode by pressing the [*/Reset] button for 2 seconds. This brings you back to the Programmer's Mode. To exit the Programmer's Mode, press the [*/Reset] button for 2 seconds.

- If the zone is unsuccessfully programmed, the keypad will sound a three-beep error tone.

16.0 Troubleshooting Guide

16.1 Keypad Problems

Symptom	Probable Cause	Possible Solution
Entry Error: Please Re-enter will display on keypad. A three beep error tone will sound continuously.	<ul style="list-style-type: none"> a) Two or more keypads share the same address. b) The DS7430 or DS7433 is installed in the wrong pins. 	<ul style="list-style-type: none"> a) Install keypad jumper properly in back of keypads. b) Be sure the DS7430 or DS7433 is installed properly.
Keypad displays Not Programmed, See Instal Guide , sounder is on and the keypad does not operate.	<ul style="list-style-type: none"> a) The keypad not addressed properly. b) The keypad is not programmed properly. c) Keypads 11-15 are not properly configured. 	<ul style="list-style-type: none"> a) Install the keypad jumper properly in the back of the keypad. b) Check keypad programming addresses 0173-0180. c) Check keypad addresses 11-15. System will only see keypads on the options bus.
Keypad displays Ready to arm, partition 1 when using only one partition. Keypad displays System Fault , sounder is on, and the keypad does not operate.	<p>The keypad is programmed as a Master keypad.</p> <ul style="list-style-type: none"> a) Keypad wiring error. b) Keypad(s) assigned to wrong or non-existent partition. c) The microprocessor isn't running. 	<p>Master keypads can only be used on multi-partition systems. Program the keypad as a standard keypad.</p> <ul style="list-style-type: none"> a) Check wiring. b) Assign the keypad(s) to correct partition. If none of the keypads are correctly assigned, re-enable keypad 1 by shorting the program contacts in the lower right corner of the main panel board. This will force program mode and assign keypad 1 as alpha, non-master to partition 1. c) Disconnect battery and any aux. power load. If the microprocessor has shut down, aux. power will read approx. 11.5 VDC. If the EEPROM chip has been field-replaced, power down AC and battery, and check for bent or mis-inserted pins; Otherwise, replace the panel.
Keypad alpha display is locked up, but the keys still function.	The keypad is enabled, but as an LED keypad.	Enter the program mode at the keypad and input the correct sequence to re-enable it as an alpha keypad. Care must be taken, since there will be no visual feedback to verify programming until the keypad is properly enabled.
Can't read back history with # 89 input.	<ul style="list-style-type: none"> a) Entering from Master keypad. b) Not using a PIN with test authority. 	<ul style="list-style-type: none"> a) First enter Single Partition Mode. b) Use a PIN with test authority.
In history, the Read-back for the A, B, and C keys shows: A = Fire B = Emergency C = Panic But, the Central Station transmissions display B as Silent Panic and C as Audible Panic.	<p>Formats display information regarding the B and C keys differently.</p> <p>In Contact ID: A = Fire B = Silent Panic C = Audible Panic</p> <p>In SIA: A = Fire B = Emergency C = Panic</p>	Discrepancy exists in the definition of these keys in the two formats. Whatever the keys are programmed for in the panel, that is what will be sent.
Can not perform a zone test (#81).	<ul style="list-style-type: none"> a) Entering from a Master keypad. b) Not using a PIN with test authority. 	<ul style="list-style-type: none"> a) Zone test is not available from a Master keypad. b) Use a PIN with test authority.

Keypad Problems (Continued)

Symptom	Probable Cause	Possible Solution
Chime Mode (#7) does not work when a zone is faulted.	<p>a) Not activating for interior zones.</p> <p>b) The keypad is not assigned to the same partition as the zone being activated.</p>	<p>a) Chime mode only activates for perimeter zones - Chime mode must be programmed. Also, if the perimeter zone has trouble enabled (trouble on open), the chime won't work if that zone is opening.</p> <p>b) Chime mode will only activate the sounder on keypads that are assigned to the same partition as the zone.</p>
Some functions won't work on a Master keypad.	Some functions require you to enter single partition mode when using a Master keypad.	<p>The following commands require that you are in Single Partition Mode when entering from a Master keypad:</p> <ul style="list-style-type: none"> • History read-back • Chime mode • Checking zone status • Checking zone trouble status (after #87 - Master keypad will show only partition name) • Bypassing zones

16.2 Reporting Problems

Symptom	Probable Cause	Possible Solution
Won't send open or close reports.	Not programmed correctly.	Check addresses: 0320, 0321, 0323, and 0187.
Reports for partitions 2-8 are being sent with partition 1's reporting ID.	The account codes for 2-8 are not programmed or are not programmed correctly.	Check addresses: 0496-0526.
Not getting AC power fail reports.	<p>a) AC power fail messages are sent only with other reports, such as low battery.</p> <p>b) Check AC report offset (0197). If 00, AC report will work like above, if another number, AC report will be delayed.</p>	<p>a) Try forcing another report to send when AC is not present.</p> <p>b) Wait until the delay times out or set to a lower number if desired.</p>
Panel never transmits history to WDSRP.	<p>a) Not programmed to send history.</p> <p>b) Time and date not set.</p>	<p>a) Check programming.</p> <p>b) Verify that the time in the panel is set.</p>
The communicator test report is not being sent.	<p>a) Report not programmed properly.</p> <p>b) There was a control problem at the time the report should have been sent. If this is the case, the communicator test report will not be sent. Instead, the control will send the "System Off Normal" report.</p>	<p>a) Check programming addresses 1521, 1522, 1525, and 0329.</p> <p>b) Program "System Off Normal" report in address 0336.</p>

16.3 Zone Problems

Symptom	Probable Cause	Possible Solution
Fire Alarm displays on keypad but no zone numbers are displayed.	In Commercial Fire Mode, fire alarms must be silenced before the zone number will display.	Enter a valid disarm [PIN] and press [#], then enter a valid disarm [PIN] and press [#] again to display the zones.
Every other zone displays Not Ready .	Zone Programming is incorrect.	Program as a multiple zone input for DS7432 or DS7460, a single zone input for contacts and sensors, or program as a DS7465.

Zone Problems (Continued)

Symptom	Probable Cause	Possible Solution
<p>Zones 9 and above show Not Ready, Zone Trouble.</p>  <p>Never disconnect the power when in the programming mode. Always disconnect the Multiplex Bus or have the DS7430 or DS7436 in the disable programming mode when powering up or down.</p>	<p>a) The multiplex expansion module is not installed properly.</p> <p>b) Multiplex wiring is missing or is not installed properly.</p> <p>c) 8-Input remote module DIP switches are not set properly.</p> <p>d) 8-Input remote module covers are removed.</p> <p>e) The BusLoc® code is set incorrectly or has not been programmed into modules.</p> <p>f) Zone Programming is incorrect.</p> <p>g) Multiplex module not programmed.</p> <p>h) Multiplex Bus voltage is 12VDC or greater. (Normal is approximately 8 to 10VDC.)</p> <p>i) Multiplex Bus voltage is 5VDC or less. (Normal is approximately 8 to 10VDC.)</p>	<p>a) Make sure the multiplex expansion module is seated properly in the upper pins on the DS7400Xi circuit board.</p> <p>b) Check wiring and perform a system reset.</p> <p>c) Correctly set the DIP switches for the 8-Input remote modules.</p> <p>d) Replace covers or install the tamper bypass jumper.</p> <p>e) BusLoc® can not be used with 8-Input remote modules. If using 8-Input modules, remove the BusLoc® code.</p> <p style="text-align: center;">OR</p> <p>If using two-input remote modules or the DS7465, be sure to use BusLoc® when programming. If not using BusLoc®, be sure to remove the BusLoc® code from address 9999.</p> <p>f) Program as a multiple zone input for DS7432 or DS7460, a single zone input for contacts and sensors, or program as a DS7465.</p> <p>g) Program the module.</p> <p>h) Two modules are programmed with the same address. The problem will only occur when both modules are off normal. Isolate the duplicate module by disconnecting sections of the bus and performing a [PIN] + [System Reset]. Reprogram modules.</p> <p style="text-align: center;">OR</p> <p>The system is in the programming mode. Exit the programming mode.</p> <p style="text-align: center;">OR</p> <p>Zones have been added to a system protected by Busloc®. Clear Busloc®.</p> <p>i) There is a short on the multiplex bus.</p> <p style="text-align: center;">OR</p> <p>There is a bad module on the bus.</p> <p style="text-align: center;">OR</p> <p>One or more modules on the bus are connected backwards - reverse polarity.</p>
Invisible or silent zone activates alarm output.	The output is programmed as "latch on alarm" (0).	Program the output to follow zone alarms (6).
Keypad displays Fire Trouble , but does not indicate any zones.	A ground fault condition exists.	See system trouble: Ground fault.
Keypad displays Not Ready , but no zone number is displayed.	An invisible zone is not ready.	Press [PIN] + [OFF] to display the zone number of the invisible zone that is not ready.

16.4 General System Problems

Symptom	Probable Cause	Possible Solution
How to set the programming values to the factory default.	Enter a value of 01 in address 4058.	Caution: Only enter a value of 01 in address 4058 when you are sure you want to default the programming. Doing so will immediately erase all programming.

General System Problems (Continued)

Symptom	Probable Cause	Possible Solution
Power LED is flashing, keypad displays Control Trouble Press #87.	A control trouble exists.	Press #87 to determine the trouble condition.
#87 display = Oct. Relay Fault #89 display = System Fault 20	a) The octal relay module (DS7488) is defective or the wiring to the module is defective. b) There is no DS7488 or a DS7488 has been removed from the system.	a) Check the wiring to the module. b) Enter, then exit programming mode. This will re-scan the options bus and clear the problem.
#87 display = Multiplex Bus Fault	The Multiplex Bus is defective or shorted.	Check wiring for shorts.
Can't reset to factory default.	Keypad programming access is set to PARTIAL from Remote programmer.	Change setting to FULL from the Remote programmer.
#87 display = RAM Fault #89 display = System Fault 01 or #87 display = ROM Fault #89 display = System Fault 02 or #87 display = EEPROM Fault #89 display = System Fault 03		a) An EEPROM fault can be caused by disconnecting power from the control while it is in program mode. In this case, enter then exit program mode to clear. b) Try to clear the error at the keypad by entering a [PIN] then [Reset]. c) Remove AC and battery power, then re-apply. Remember that event history will be lost and time/date will have to be reset. d) If error persists, return the panel to factory default programming by setting program address 4058 to "01". If the error clears, re-program the panel. e) If error still persists, replace the panel.
#87 display = Communicator Err #89 display = Report Failure X	The control has failed to communicate.	Check history #89 to determine the source: Report Failure 1 = Phone number 1 Report Failure 2 = Phone number 2 Report Failure 3 = Phone number 3 (remote programmer) Report Failure 4 = ARDIS Network
#87 display = 2Ph/Bell Fault #89 display = System Fault 10	a) The dual phone line/bell supervision module (DS7420i) is defective or the wiring to the module is defective. b) There is no DS7420i or a DS7420i has been removed from the system.	a) Check the wiring to the module. b) Enter, then exit programming mode. This will re-scan the options bus and clear the problem.
#87 display = Line 1 Fault #89 display = System Fault 11	There is a phone line fault on line 1.	Check phone line 1 for proper operation.
#87 display = Line 2 Fault #89 display = System Fault 12	There is a phone line fault on line 2.	Check phone line 2 for proper operation. If you wish to monitor only one phone line, reprogram address 1520.
#87 display = Bell Fault #89 display = System Fault 13	The bell circuit on the DS7420i is open or shorted.	Check the bell circuit wiring. Be sure that the end-of-line resistor is in place. If you don't wish to use the bell circuit, place an end-of-line resistor across the bell terminals.
#87 display = Aux. Output Fault #89 display = System Fault 14	The auxiliary circuit on the DS7420i is open or shorted.	Check the auxiliary circuit wiring. Be sure that the end-of-line resistor is in place. If you don't wish to use the auxiliary circuit, place an end-of-line resistor across the auxiliary terminals. If you wish to use the auxiliary circuit but do not wish to supervise it, cut the auxiliary supervision jumper on the DS7420i.

General System Problems (Continued)

Symptom	Probable Cause	Possible Solution
#87 display = Aux Power Fault	The auxiliary power output has been shorted.	Remove wiring from auxiliary power and check for shorts.
#87 display = Keypad Fault	a) The keypad wiring is defective. b) A keypad is missing. c) A keypad has been programmed, but is not intended in this system.	a) Check keypad operation and wiring. b) Install a keypad. c) Remove from programming (0173-0180).
#87 display = Ground Fault #89 display = System Fault 04	There is a short to ground somewhere in the system.	Disconnect field wiring from each terminal while watching the keypad display. When the keypad power LED stops flashing, you have found the wire that is causing the ground fault. Note: The LED will not stop flashing if there is another system fault present. If there is no keypad nearby, or another control problem exists, you can use a volt-meter to find the ground fault: 1) Connect the negative lead of a volt-meter to the panel ground terminal. 2) Connect the positive terminal to the Aux Power – terminal. You should read -4.5 to -7.5 Volts DC. A reading considerably higher or lower indicates a ground fault. Disconnect field wiring from each terminal while watching the meter. When the voltage reading returns to between -4.5 and -7.5 VDC, you have found the wire that is causing the ground fault.
#87 display = AR IB Queue Full #89 display = System Fault 51	The message queue in the RF modem is full and no messages can get out to the radio network.	Check RF coverage of the unit and check for RF noisy environment.
#87 display = AR Host Down #89 display = System Fault 52	The central station receiver has ceased to be available to the network.	Contract the central station and notify of status.
#87 display = AR Unreg. Modem #89 display = System Fault 53	The modem is not registered through all parts of the network.	Contact the network administrators or technical service.
#87 display = AR Power Fail #89 display = System Fault 54	There is a possible problem with the ARDIS Module unit.	Return for service.
#87 display = AR Network Lost #89 display = System Fault 55	The ARDIS Module has lost contact with the radio network.	Check the location and coverage of the unit.
#87 display = AR Modem HW Err #89 display = System Fault 56	There is a possible problem with the radio modem.	Replace the unit.
#87 display = AR Modem SW Err #89 display = System Fault 57	The ARDIS Module is having some trouble communicating with the radio modem.	Check for noisy environment and replace the unit if the problem continues.
#87 display = AR Opt. Bus Err #89 display = System Fault 58	The panel can no longer communicate with the ARDIS Module.	Check the wiring between the DS7400Xi and the ARDIS Module.
#87 display = AR Corrupt MSG #89 display = System Fault 59	The communication between the panel and the ARDIS Module is getting corrupted.	Check for noisy environment, and check the wiring between the DS7400Xi and the ARDIS Module.
Unable to arm the system.	a) Zone(s) faulted. b) If an AC failure exists, you must force arm.	a) Determine the cause of the problem and clear the indicated zone(s). b) Enter an arming sequence, then press the Bypass key during a 5 second beep.

General System Problems (Continued)

Symptom	Probable Cause	Possible Solution
#87 display = Battery Trouble	<p>a) The battery failed a battery test.</p> <p>b) The battery is defective.</p> <p>c) The wiring to the battery is disconnected.</p>	<p>a) If there has just been a power failure, wait at least two hours for the battery to recharge then perform a System Reset to re-test the battery and clear the error.</p> <p>b) Replace the battery.</p> <p>c) Check wiring.</p>
#87 display = Zone Trouble	<p>a) A zone is not responding to the control panel.</p> <p>b) The zone is programmed for "Trouble on Open" and the loop is open.</p> <p>There is a power failure and the panel is operating on battery backup. If there is a general power failure, wait for the power to return. If there is not a general power failure in the building.</p>	<p>a) Check wiring to the zone. OR If the zone is not to be used, remove from programming.</p> <p>b) If using Normally Closed contacts, re-program zone for alarm on open. OR If using Normally Open contacts and trouble on open is desired, check for opens in the loop. Remove wiring and place an EOL resistor across the zone to eliminate a problem with the control. If the trouble goes away, the problem is in the wiring or in a contact connected to the zone.</p>
#87 display = AC Power Failure	<p>a) The transformer is unplugged.</p> <p>b) The wiring from the transformer is defective.</p> <p>c) The circuit to the transformer is off or defective.</p> <p>d) The transformer is defective.</p> <p>e) In some cases, the transformer may be connected to a circuit controlled by a switch or a circuit breaker that is periodically turned off.</p>	<p>a) Plug the transformer in.</p> <p>b) Check the wiring.</p> <p>c) Check the circuit and circuit breakers.</p> <p>d) Replace the transformer.</p> <p>e) Connect to a circuit that is not controlled this way.</p>
Fire Alarm displays "000".	The Fire Alarm was caused by the "A" key.	Use the System Reset command to clear the display.
Fire Trouble, no zone number.	When in Commercial Fire Mode, a ground fault causes this display.	See #87 Ground Fault display for solution.
Fire Trouble _____ zone number.	Fire zone wiring problems.	If you try to disable the zone by reprogramming it, you need to reset the control by either entering then exiting programmer's mode, or removing then restoring power to the control panel.
Dirty Chamber _____ zone number.	A multiplex smoke detector has failed its internal sensitivity test.	Clean or replace the dirty smoke detector or chamber. DO NOT USE WATER TO CLEAN THE CHAMBER.

17.0 Program Addresses

Address	Description	Address	Description	Address	Description
0000	General Control	0063	Zone Number 46	0126	Zone Number 109
0001	Zone Function 1	0064	Zone Number 47	0127	Zone Number 110
0002	Zone Function 2	0065	Zone Number 48	0128	Zone Number 111
0003	Zone Function 3	0066	Zone Number 49	0129	Zone Number 112
0004	Zone Function 4	0067	Zone Number 50	0130	Zone Number 113
0005	Zone Function 5	0068	Zone Number 51	0131	Zone Number 114
0006	Zone Function 6	0069	Zone Number 52	0132	Zone Number 115
0007	Zone Function 7	0070	Zone Number 53	0133	Zone Number 116
0008	Zone Function 8	0071	Zone Number 54	0134	Zone Number 117
0009	Zone Function 9	0072	Zone Number 55	0135	Zone Number 118
0010	Zone Function 10	0073	Zone Number 56	0136	Zone Number 119
0011	Zone Function 11	0074	Zone Number 57	0137	Zone Number 120
0012	Zone Function 12	0075	Zone Number 58	0138	Zone Number 121
0013	Zone Function 13	0076	Zone Number 59	0139	Zone Number 122
0014	Zone Function 14	0077	Zone Number 60	0140	Zone Number 123
0015	Zone Function 15	0078	Zone Number 61	0141	Zone Number 124
0016	Zone Bypass	0079	Zone Number 62	0142	Zone Number 125
0017	Zone Bypass	0080	Zone Number 63	0143	Zone Number 126
0018	Zone Number 1	0081	Zone Number 64	0144	Zone Number 127
0019	Zone Number 2	0082	Zone Number 65	0145	Zone Number 128
0020	Zone Number 3	0083	Zone Number 66	0146	Alarm Output
0021	Zone Number 4	0084	Zone Number 67	0147	Programmable Output 1
0022	Zone Number 5	0085	Zone Number 68	0148	Programmable Output 2
0023	Zone Number 6	0086	Zone Number 69	0149	Output Partition Assignment
0024	Zone Number 7	0087	Zone Number 70	0150	Output Partition Assignment
0025	Zone Number 8	0088	Zone Number 71	0165	Partition Control
0026	Zone Number 9	0089	Zone Number 72	0169	Quick Arm Control
0027	Zone Number 10	0090	Zone Number 73	0173	Keypad Assignment
0028	Zone Number 11	0091	Zone Number 74	0174	Keypad Assignment
0029	Zone Number 12	0092	Zone Number 75	0175	Keypad Assignment
0030	Zone Number 13	0093	Zone Number 76	0176	Keypad Assignment
0031	Zone Number 14	0094	Zone Number 77	0177	Keypad Assignment
0032	Zone Number 15	0095	Zone Number 78	0178	Keypad Assignment
0033	Zone Number 16	0096	Zone Number 79	0179	Keypad Assignment
0034	Zone Number 17	0097	Zone Number 80	0180	Keypad Assignment
0035	Zone Number 18	0098	Zone Number 81	0181	Emergency Key
0036	Zone Number 19	0099	Zone Number 82	0182	Panic Key
0037	Zone Number 20	0100	Zone Number 83	0183	Custom Arming
0038	Zone Number 21	0101	Zone Number 84	0184	Custom Arming
0039	Zone Number 22	0102	Zone Number 85	0185	Force Arming & Ground Fault
0040	Zone Number 23	0103	Zone Number 86	0186	Commercial Fire Mode
0041	Zone Number 24	0104	Zone Number 87	0187	Open/Close Report Control
0042	Zone Number 25	0105	Zone Number 88	0189	Open/Close/Zone Rprt. Cntrl.
0043	Zone Number 26	0106	Zone Number 89	0190	Report Control
0044	Zone Number 27	0107	Zone Number 90	0191	Entry Delay Time 1
0045	Zone Number 28	0108	Zone Number 91	0192	Entry Delay Time 2
0046	Zone Number 29	0109	Zone Number 92	0193	Exit Delay Time
0047	Zone Number 30	0110	Zone Number 93	0195	Fire Bell Cutoff
0048	Zone Number 31	0111	Zone Number 94	0196	Burglary Bell Cutoff
0049	Zone Number 32	0112	Zone Number 95	0197	AC Fail Report Delay
0050	Zone Number 33	0113	Zone Number 96	0198	General Code: Arm Only
0051	Zone Number 34	0114	Zone Number 97	0199	General Code: Arm Only
0052	Zone Number 35	0115	Zone Number 98	0200	General Code: Arm Only
0053	Zone Number 36	0116	Zone Number 99	0201	General Code: Arm Only
0054	Zone Number 37	0117	Zone Number 100	0202	Arming Warning
0055	Zone Number 38	0118	Zone Number 101	0203	Arming Warning
0056	Zone Number 39	0119	Zone Number 102	0204	Arming Warning
0057	Zone Number 40	0120	Zone Number 103	0205	Arming Warning
0058	Zone Number 41	0121	Zone Number 104	0206	DS7412 Interface Control
0059	Zone Number 42	0122	Zone Number 105	0207	DS7412 Interface Config.
0060	Zone Number 43	0123	Zone Number 106	0208	Keypad Partition Assign.
0061	Zone Number 44	0124	Zone Number 107	0209	Keypad Partition Assign.
0062	Zone Number 45	0125	Zone Number 108	0210	Keypad Partition Assign.

Address	Description	Address	Description	Address	Description
0211	Keypad Partition Assign.	0329	Comm. Test/SystemNormal Report	0516	Account Code #1 Partition 6
0212	Keypad Partition Assign.	0330	Remote Prog. Successful Report	0518	Account Code #2 Partition 6
0213	Keypad Partition Assign.	0331	Remote Prog. Unsuccessful Report	0520	Account Code #1 Partition 7
0214	Keypad Partition Assign.	0332	Local Prog. Successful Rprt.	0522	Account Code #2 Partition 7
0215	Keypad Partition Assign.	0333	Local Prog. Unsuccessful Report	0524	Account Code #1 Partition 8
0256	Keypad Fire Alarm Report	0334	System Trouble Report	0526	Account Code #2 Partition 8
0257	Keypad Fire Restoral Report	0335	Sys. Trouble Restoral Rprt.	0528	Phone Number Gen. Cntrl.
0258	Zone Func. 1 Alarm Report	0336	Communicator Test/System Off	0529	Phone Number 1 Format
0259	Zone Func. 2 Alarm Report		Normal Report	0530	Phone Number 2 Format
0260	Zone Func. 3 Alarm Report	0337	Exit Error Report	0531	Phone Answering
0261	Zone Func. 4 Alarm Report	0338	Recent Closing Report	0532	Programmer's Code
0262	Zone Func. 5 Alarm Report	0339	System Walk Test Report	0534	Master Code
0263	Zone Func. 6 Alarm Report	0340	System Walk Test Restoral	1248	Zone 1 & 2 Part. Assign.
0264	Zone Func. 7 Alarm Report	0341	Fire Walk Test Report	1249	Zone 3 & 4 Part. Assign.
0265	Zone Func. 8 Alarm Report	0342	Fire Walk Test Restoral	1250	Zone 5 & 6 Part. Assign.
0266	Zone Func. 9 Alarm Report	0343	Mux Low Temperature Report	1251	Zone 7 & 8 Part. Assign.
0267	Zone Func. 10 Alarm Report	0344	Mux Low Temperature Restoral	1252	Zone 9 & 10 Part. Assign.
0268	Zone Func. 11 Alarm Report	0345	Dirty Smoke Chamber Report	1253	Zone 11 & 12 Part. Assign.
0269	Zone Func. 12 Alarm Report	0346	Dirty Smoke Chamber Restoral	1254	Zone 13 & 14 Part. Assign.
0270	Zone Func. 13 Alarm Report	0347	Zone Funct. 01 Bypass	1255	Zone 15 & 16 Part. Assign.
0271	Zone Func. 14 Alarm Report	0348	Zone Funct. 02 Bypass	1256	Zone 17 & 18 Part. Assign.
0272	Zone Func. 15 Alarm Report	0349	Zone Funct. 03 Bypass	1257	Zone 19 & 20 Part. Assign.
0273	Keypad Emergency Report	0350	Zone Funct. 04 Bypass	1258	Zone 21 & 22 Part. Assign.
0274	Keypad Panic Report	0351	Zone Funct. 05 Bypass	1259	Zone 23 & 24 Part. Assign.
0275	Zone Func. 1 Restoral Rpt.	0352	Zone Funct. 06 Bypass	1260	Zone 25 & 26 Part. Assign.
0276	Zone Func. 2 Restoral Rpt.	0353	Zone Funct. 07 Bypass	1261	Zone 27 & 28 Part. Assign.
0277	Zone Func. 3 Restoral Rpt.	0354	Zone Funct. 08 Bypass	1262	Zone 29 & 30 Part. Assign.
0278	Zone Func. 4 Restoral Rpt.	0355	Zone Funct. 09 Bypass	1263	Zone 31 & 32 Part. Assign.
0279	Zone Func. 5 Restoral Rpt.	0356	Zone Funct. 10 Bypass	1264	Zone 33 & 34 Part. Assign.
0280	Zone Func. 6 Restoral Rpt.	0357	Zone Funct. 11 Bypass	1265	Zone 35 & 36 Part. Assign.
0281	Zone Func. 7 Restoral Rpt.	0358	Zone Funct. 12 Bypass	1266	Zone 37 & 38 Part. Assign.
0282	Zone Func. 8 Restoral Rpt.	0359	Zone Funct. 13 Bypass	1267	Zone 39 & 40 Part. Assign.
0283	Zone Func. 9 Restoral Rpt.	0360	Zone Funct. 14 Bypass	1268	Zone 41 & 42 Part. Assign.
0284	Zone Func. 10 Restoral Rpt.	0361	Zone Funct. 15 Bypass	1269	Zone 43 & 44 Part. Assign.
0285	Zone Func. 11 Restoral Rpt.	0362	Zone Func. 01 Bypass Restoral	1270	Zone 45 & 46 Part. Assign.
0286	Zone Func. 12 Restoral Rpt.	0363	Zone Func. 02 Bypass Restoral	1271	Zone 47 & 48 Part. Assign.
0287	Zone Func. 13 Restoral Rpt.	0364	Zone Func. 03 Bypass Restoral	1272	Zone 49 & 50 Part. Assign.
0288	Zone Func. 14 Restoral Rpt.	0365	Zone Func. 04 Bypass Restoral	1273	Zone 51 & 52 Part. Assign.
0289	Zone Func. 15 Restoral Rpt.	0366	Zone Func. 05 Bypass Restoral	1274	Zone 53 & 54 Part. Assign.
0290	Zone Func. 1 Trouble Rpt.	0367	Zone Func. 06 Bypass Restoral	1275	Zone 55 & 56 Part. Assign.
0291	Zone Func. 2 Trouble Rpt.	0368	Zone Func. 07 Bypass Restoral	1276	Zone 57 & 58 Part. Assign.
0292	Zone Func. 3 Trouble Rpt.	0369	Zone Func. 08 Bypass Restoral	1277	Zone 59 & 60 Part. Assign.
0293	Zone Func. 4 Trouble Rpt.	0370	Zone Func. 09 Bypass Restoral	1278	Zone 61 & 62 Part. Assign.
0294	Zone Func. 5 Trouble Rpt.	0371	Zone Func. 10 Bypass Restoral	1279	Zone 63 & 64 Part. Assign.
0295	Zone Func. 6 Trouble Rpt.	0372	Zone Func. 11 Bypass Restoral	1280	Zone 65 & 66 Part. Assign.
0296	Zone Func. 7 Trouble Rpt.	0373	Zone Func. 12 Bypass Restoral	1281	Zone 67 & 68 Part. Assign.
0297	Zone Func. 8 Trouble Rpt.	0374	Zone Func. 13 Bypass Restoral	1282	Zone 69 & 70 Part. Assign.
0298	Zone Func. 9 Trouble Rpt.	0375	Zone Func. 14 Bypass Restoral	1283	Zone 71 & 72 Part. Assign.
0299	Zone Func. 10 Trouble Rpt.	0376	Zone Func. 15 Bypass Restoral	1284	Zone 73 & 74 Part. Assign.
0300	Zone Func. 11 Trouble Rpt.	0377	Keypad Tamper	1285	Zone 75 & 76 Part. Assign.
0301	Zone Func. 12 Trouble Rpt.	0378	Keypad Tamper Restoral	1286	Zone 77 & 78 Part. Assign.
0302	Zone Func. 13 Trouble Rpt.	0494	Phone/ARDIS Routing Cntrl.	1287	Zone 79 & 80 Part. Assign.
0303	Zone Func. 14 Trouble Rpt.	0495	Phone/ARDIS Routing Cntrl.	1288	Zone 81 & 82 Part. Assign.
0304	Zone Func. 15 Trouble Rpt.	0496	Account Code #1 Partition 1	1289	Zone 83 & 84 Part. Assign.
0320	Open Report	0498	Account Code #2 Partition 1	1290	Zone 85 & 86 Part. Assign.
0321	Close Report	0500	Account Code #1 Partition 2	1291	Zone 87 & 88 Part. Assign.
0322	Duress Report	0502	Account Code #2 Partition 2	1292	Zone 89 & 90 Part. Assign.
0323	Partial Close Report	0504	Account Code #1 Partition 3	1293	Zone 91 & 92 Part. Assign.
0324	First Open After Alarm Rpt.	0506	Account Code #2 Partition 3	1294	Zone 93 & 94 Part. Assign.
0325	Low Battery Report	0508	Account Code #1 Partition 4	1295	Zone 95 & 96 Part. Assign.
0326	Battery Restoral Report	0510	Account Code #2 Partition 4	1296	Zone 97 & 98 Part. Assign.
0327	AC Fail Report	0512	Account Code #1 Partition 5	1297	Zone 99 & 100 Part. Assign.
0328	AC Restoral Report	0514	Account Code #2 Partition 5	1298	Zone 101 & 102 Part. Assign.

Address	Description	Address	Description	Address	Description
1299	Zone 103 & 104 Part. Assign.	1734	Alpha for Zone Number 6	2742	Alpha for Zone Number 69
1300	Zone 105 & 106 Part. Assign.	1750	Alpha for Zone Number 7	2758	Alpha for Zone Number 70
1301	Zone 107 & 108 Part. Assign.	1766	Alpha for Zone Number 8	2774	Alpha for Zone Number 71
1302	Zone 109 & 110 Part. Assign.	1782	Alpha for Zone Number 9	2790	Alpha for Zone Number 72
1303	Zone 111 & 112 Part. Assign.	1798	Alpha for Zone Number 10	2806	Alpha for Zone Number 73
1304	Zone 113 & 114 Part. Assign.	1814	Alpha for Zone Number 11	2822	Alpha for Zone Number 74
1305	Zone 115 & 116 Part. Assign.	1830	Alpha for Zone Number 12	2838	Alpha for Zone Number 75
1306	Zone 117 & 118 Part. Assign.	1846	Alpha for Zone Number 13	2854	Alpha for Zone Number 76
1307	Zone 119 & 120 Part. Assign.	1862	Alpha for Zone Number 14	2870	Alpha for Zone Number 77
1308	Zone 121 & 122 Part. Assign.	1878	Alpha for Zone Number 15	2886	Alpha for Zone Number 78
1309	Zone 123 & 124 Part. Assign.	1894	Alpha for Zone Number 16	2902	Alpha for Zone Number 79
1310	Zone 125 & 126 Part. Assign.	1910	Alpha for Zone Number 17	2918	Alpha for Zone Number 80
1311	Zone 127 & 128 Part. Assign.	1926	Alpha for Zone Number 18	2934	Alpha for Zone Number 81
1456	Octal Module #1, Relay #1	1942	Alpha for Zone Number 19	2950	Alpha for Zone Number 82
1457	Octal Module #1, Relay #2	1958	Alpha for Zone Number 20	2966	Alpha for Zone Number 83
1458	Octal Module #1, Relay #3	1974	Alpha for Zone Number 21	2982	Alpha for Zone Number 84
1459	Octal Module #1, Relay #4	1990	Alpha for Zone Number 22	2998	Alpha for Zone Number 85
1460	Octal Module #1, Relay #5	2006	Alpha for Zone Number 23	3014	Alpha for Zone Number 86
1461	Octal Module #1, Relay #6	2022	Alpha for Zone Number 24	3030	Alpha for Zone Number 87
1462	Octal Module #1, Relay #7	2038	Alpha for Zone Number 25	3046	Alpha for Zone Number 88
1463	Octal Module #1, Relay #8	2054	Alpha for Zone Number 26	3062	Alpha for Zone Number 89
1464	Octal Module #2, Relay #9	2070	Alpha for Zone Number 27	3078	Alpha for Zone Number 90
1465	Octal Module #2, Relay #10	2086	Alpha for Zone Number 28	3094	Alpha for Zone Number 91
1466	Octal Module #2, Relay #11	2102	Alpha for Zone Number 29	3110	Alpha for Zone Number 92
1467	Octal Module #2, Relay #12	2118	Alpha for Zone Number 30	3126	Alpha for Zone Number 93
1468	Octal Module #2, Relay #13	2134	Alpha for Zone Number 31	3142	Alpha for Zone Number 94
1469	Octal Module #2, Relay #14	2150	Alpha for Zone Number 32	3158	Alpha for Zone Number 95
1470	Octal Module #2, Relay #15	2166	Alpha for Zone Number 33	3174	Alpha for Zone Number 96
1471	Octal Module #2, Relay #16	2182	Alpha for Zone Number 34	3190	Alpha for Zone Number 97
1472	Output Function 1	2198	Alpha for Zone Number 35	3206	Alpha for Zone Number 98
1475	Output Function 2	2214	Alpha for Zone Number 36	3222	Alpha for Zone Number 99
1478	Output Function 3	2230	Alpha for Zone Number 37	3238	Alpha for Zone Number 100
1481	Output Function 4	2246	Alpha for Zone Number 38	3254	Alpha for Zone Number 101
1484	Output Function 5	2262	Alpha for Zone Number 39	3270	Alpha for Zone Number 102
1487	Output Function 6	2278	Alpha for Zone Number 40	3286	Alpha for Zone Number 103
1490	Output Function 7	2294	Alpha for Zone Number 41	3302	Alpha for Zone Number 104
1493	Output Function 8	2310	Alpha for Zone Number 42	3318	Alpha for Zone Number 105
1496	Output Function 9	2326	Alpha for Zone Number 43	3334	Alpha for Zone Number 106
1499	Output Function 10	2342	Alpha for Zone Number 44	3350	Alpha for Zone Number 107
1502	Output Function 11	2358	Alpha for Zone Number 45	3366	Alpha for Zone Number 108
1505	Output Function 12	2374	Alpha for Zone Number 46	3382	Alpha for Zone Number 109
1508	Output Function 13	2390	Alpha for Zone Number 47	3398	Alpha for Zone Number 110
1511	Output Function 14	2406	Alpha for Zone Number 48	3414	Alpha for Zone Number 111
1514	Output Function 15	2422	Alpha for Zone Number 49	3430	Alpha for Zone Number 112
1520	Dual Phone Line / Bell Supervision Module Output	2438	Alpha for Zone Number 50	3446	Alpha for Zone Number 113
1521	Comm. Test Report Timer	2454	Alpha for Zone Number 51	3462	Alpha for Zone Number 114
1523	Remote Programmer Timer	2470	Alpha for Zone Number 52	3478	Alpha for Zone Number 115
1525	Test Report & Remote Programmer Call-Out	2486	Alpha for Zone Number 53	3494	Alpha for Zone Number 116
1526	Alpha for Partition 1	2502	Alpha for Zone Number 54	3510	Alpha for Zone Number 117
1542	Alpha for Partition 2	2518	Alpha for Zone Number 55	3526	Alpha for Zone Number 118
1558	Alpha for Partition 3	2534	Alpha for Zone Number 56	3542	Alpha for Zone Number 119
1574	Alpha for Partition 4	2550	Alpha for Zone Number 57	3558	Alpha for Zone Number 120
1590	Alpha for Partition 5	2566	Alpha for Zone Number 58	3574	Alpha for Zone Number 121
1606	Alpha for Partition 6	2582	Alpha for Zone Number 59	3590	Alpha for Zone Number 122
1622	Alpha for Partition 7	2598	Alpha for Zone Number 60	3606	Alpha for Zone Number 123
1638	Alpha for Partition 8	2614	Alpha for Zone Number 61	3622	Alpha for Zone Number 124
1654	Alpha for Zone Number 1	2630	Alpha for Zone Number 62	3638	Alpha for Zone Number 125
1670	Alpha for Zone Number 2	2646	Alpha for Zone Number 63	3654	Alpha for Zone Number 126
1686	Alpha for Zone Number 3	2662	Alpha for Zone Number 64	3670	Alpha for Zone Number 127
1702	Alpha for Zone Number 4	2678	Alpha for Zone Number 65	3686	Alpha for Zone Number 128
1718	Alpha for Zone Number 5	2694	Alpha for Zone Number 66	3725	Octal Relay Partition Assign.
		2710	Alpha for Zone Number 67	3726	Octal Relay Partition Assign.
		2726	Alpha for Zone Number 68	3727	Octal Relay Partition Assign.

Address Description

3728 Octal Relay Partition Assign.
 3729 Octal Relay Partition Assign.
 3730 Octal Relay Partition Assign.
 3731 Octal Relay Partition Assign.
 3732 Octal Relay Partition Assign.
 3733 Output Func. Part. Assign.
 3734 Output Func. Part. Assign.
 3735 Output Func. Part. Assign.
 3736 Output Func. Part. Assign.
 3737 Output Func. Part. Assign.
 3738 Output Func. Part. Assign.
 3739 Output Func. Part. Assign.
 3740 Output Func. Part. Assign.
 4028 Phone Number 1
 4038 Phone Number 2
 4048 Phone Number 3

Index**Symbols**

24-Hour Zone 15
 4/2 Format 73

A

AC Failure Report Delay 19, 49
 AC Reports 19
 Access Output 17
 Access PIN 22
 Account Code Programming 55
 Ademco AB-12 Bell 72
 Alarm
 Fire - how to silence 1
 Invisible 15
 Low Temperature 16
 on Open 15
 on Short 15
 Silent 15
 Smoke 16
 Zone 17, 19
 Zone Function 19
 Alpha Description 63
 Answering Machine Bypass 20
 ARDIS 54
 Arm Only 15, 50
 Arm Only PIN 22
 Arming
 Automatic 1, 25
 Custom 1, 15, 18
 Delayed 1, 24
 Force 1, 18, 46
 From the Master Keypad 32
 Maximum Security 1, 15
 Normal 1, 15
 Perimeter 1, 15
 Perimeter Instant 1, 15
 Authority Level 22
 Automatic Arming 1, 25
 Automatic Battery Test 29
 Automatic Disarming 26

B

Backlight Control 33, 44
 Battery Reports 19
 Battery Test 1
 Automatic 29
 Manual 29
 Battery/Sounder Test 1, 29
 Bell Cutoff Delays 49
 BFSK Format 74
 Bypassing Allowed 15

C

California March Time 18
 Changing a PIN 22
 Changing the Date 23
 Changing the Time 24
 Chime Mode 1
 CID Formats 79
 Clear Displays 1
 Closing Ring-Back 15
 Commercial Fire Mode 18, 47
 California March Time 18
 Multiple Keypad Use 19
 Pulsing Fire Zone 18
 Single Keypad Use 18
 Temporal 18
 Water Flow Zone Delay 18
 Common Area 18
 Communicator Test 1, 19, 20, 30
 Custom Arming 1, 15, 18, 45

D

Day Monitor 16
 Default, Factory 34
 Delayed Arming 1, 24
 Dirty Chamber/Smoke 20, 27, 86
 Disarming
 Automatic 26
 From the Master Keypad 33
 Manual 1
 Under Duress 26
 DS7420i 61
 Duress 26
 Duress PIN 22

E

Emergency Key 18, 27, 45
 Emergency Procedures 26
 Enable Remote Programmer Callback 20
 Entry Pre-Alert 17
 Entry/Exit Delay 15, 49
 Error Display 1, 31
 Clear 1
 Event History Readback 1, 30
 Extend Automatic Arming 1, 25

F

Factory Default 34
 Fire Key 18
 Fire Reset 1, 27
 Fire Safety 27
 Fire Trouble 1, 27
 Alarm - how to silence 1
 Clear Display 1
 Fire Walk Test 1, 20, 29
 Fire Zone 16
 First Open After Alarm 19
 Flow Zone, Water 16
 Force Arming 1, 18, 46
 Formats
 4/2 73
 BFSK 74
 CID 79
 Pager 75
 SIA 77

G

General PIN 22
 Ground Fault Detect 18, 46
 Ground Start 17

H

HEX Values 34

I

Input Cross Matrix 17, 60
 Interior Delayed 15
 Interior Entry/Exit Follower 16
 Interior Home/Away 16
 Interior Instant 16
 Invisible Alarms 15

K

Keypad Alarms 27
 Keypad Assignment 18, 44
 Keypad Reports 19
 Keypad Sounder Output 17
 Keyswitch Input 16

L

Latch on Any Zone Alarm 17
 Load Number 21
 Low Temperature Alarm 16

M

Manual Battery Test 29
 Master Code 58
 Master Keypad
 Arming from 32
 Disarming from 33
 Programming 18
 Master PIN 22
 Maximum Security Arming 1, 15
 Multiple Keypad Use 19
 Multiple Zone Input 16
 Multiplex
 Bus Outputs 17
 Smoke 16
 Zone Addressing 80

N

Normal Arming 1, 15

O

Octal Relay Modules 17, 58
 ON Outputs 17
 Open/Close Reports 19, 20, 48
 Output
 Keypad Sounder 17
 Panic/Duress 17
 Partition Assignment 42
 Programming 41
 Output, Access 17
 Output Cross Matrix 17, 60
 Output Function 17
 Partition Assignment 61
 Programming 60

P

Pager Delay 68
 Pager Format 75
 Panic Key 18, 45
 Panic/Duress Output 17
 Partition Assignment 39
 Partition Control Programming 17, 42
 Perimeter Arming 1, 15
 Perimeter Instant 1, 15
 Phone Answering Programming 20, 57
 Phone Number
 Dial Pulse/Tone on All 20
 Programming 20, 56, 68
 PIN
 Authority Levels 22
 Changing 22
 Expiration Date, Temporary PIN 23
 Removing 22
 Program Addresses 87
 Programmer's Code 58
 Programming a Zone 37
 Pulsing Fire Zone 18

Q

Quick Arm Control 43

R

Receivers 57
 Remote Program Dial-out & Answer 1, 30
 Remote Program Reports 20
 Removing a PIN 22
 Report Programming 19, 52
 Reports
 AC 19
 Battery 19
 Communicator Test 19, 20
 Dirty Chamber 20, 27
 Duress 19
 Exit Error 20
 Keypad 19
 Local Program 20
 Mux. Smoke Low Temperature 20
 Open/Close 19, 20
 Remote Program 20
 System Trouble 20
 Walk Test 20
 Zone 19
 Zone Restoral 15
 RS232 Interface 51

S

SIA Formats 77
 Silencing Alarms 1, 26
 Silent Alarms 15
 Single Keypad Use 18
 Single Partition Mode 33
 Single Zone Input 16
 Siren on Communication Fail 15
 Smoke Alarm 16
 Solid State Output Modules 17
 Special Emergency Key 18
 Supervisory Zone 16
 Swinger Shunts 15
 System Problems 83
 System Status (ready to arm) 17
 System Walk Test 1, 20, 28

T

Temporal 18
 Temporary PIN 22
 Temporary PIN Expiration Date 23
 Test
 Battery 1, 29
 Battery/Sounder 1, 29
 Communicator 30
 Fire Walk 1
 System Walk 1
 Test Report 62
 Timer Programming 62
 Trouble
 Fire 27
 On Open 15
 On Short 15
 Zone Function 19

U

U. L. Listings 69
 Unlimited PIN 22
 User Number 22

V

Volume Control 33

W

Walk Test Reports 20
 Warnings 31
 Water Flow Zone 16
 Water Flow Zone Delay 18
 WDSRP 51

Z

Zone
 24-Hour 15
 Alarm 17
 Alarm Delayed 17
 Bypass 1, 40
 Fire 16
 Multiplex 80
 Multiplex Smoke 16
 Problems 82
 Pulsing Fire 18
 Supervisory 16
 Water Flow 16
 Zone Function 15
 Alarm 19
 Bypass 19
 Programming 15, 37
 Trouble 19
 Zone Restoral Reports 15

