

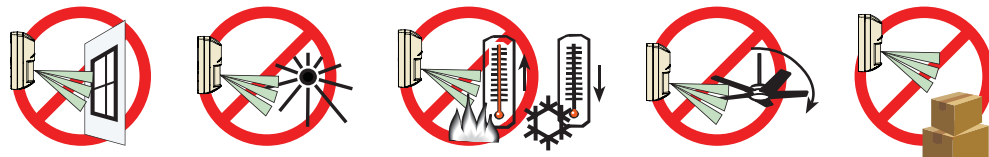

**Installation Guide**

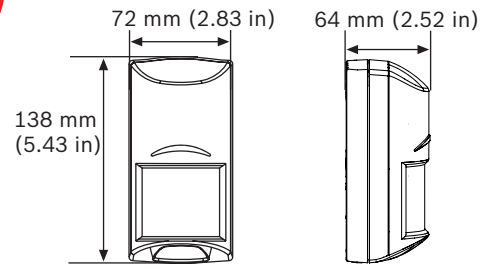

**Pet Friendly**  
1 dog ≤ 45 kg (100 lbs)  
2 dogs ≤ 27 kg (60 lbs)  
or up to 10 cats  
Not tested by UL

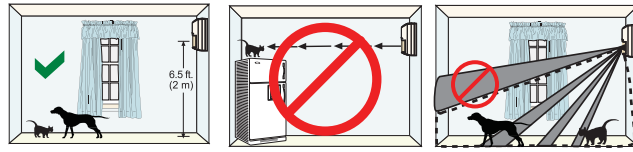

2 - 2.4 m  
(6.5 - 7.8 ft)

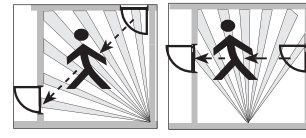

**UL - only model RFDL-11-A is evaluated by UL**

UL639: Standard for Intrusion-Detection Units  
(Pet Friendly Immunity is not a feature of UL639)

FCC, Part 15

**CE**  
**EN**  
EN 50131-2-4  
EN 50131-5-3  
Grade 2  
Environment Class II

**INCERT**  
B-509-0069  
RFDL-11 only

**VdS**  
H116003  
RFDL-11 only

Duracell MN1500 AA Alkaline 6 VDC  
Panasonic AM-3PIX AA Alkaline 6 VDC  
Duracell PC1500

433.42 MHz

0 - 93% Non-condensing humidity

P/N: F.01U.261.834 - B810  
P/N: F.01U.261.835 - RFRC-OPT

Functional range: -10°C to +49°C (+14°F to +120°F)  
UL only: 0°C to +49°C (+32°F to +120°F)  
EN 50130-5 Class II only: -10°C to +40°C (+14°F to +104°F)

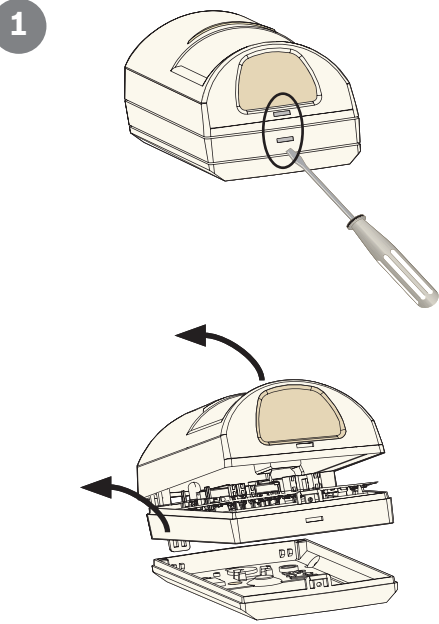

↑	←	→
	6.1 m (20 ft)	10.7 m (35 ft)
2 m (6.5 ft)	-7°	-5°
2.1 m (6.9 ft)	-9°	-6°
2.4 m (7.8 ft)	-10°	-7°

**EN** ✓

**EN** ✓

**UP** ↑↑

AA Alkaline, 1.5 VDC

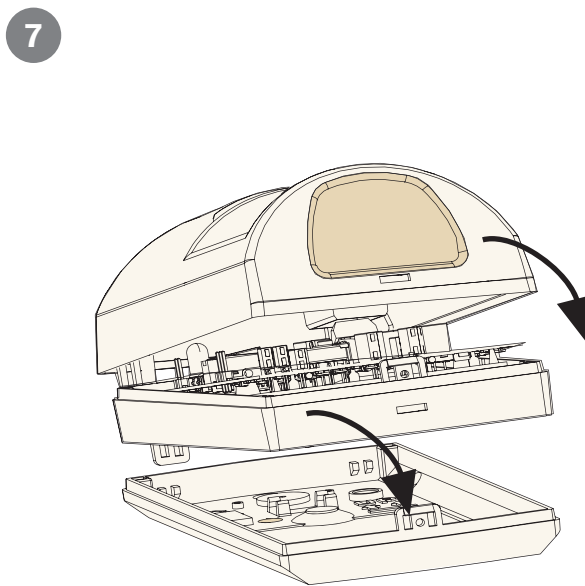

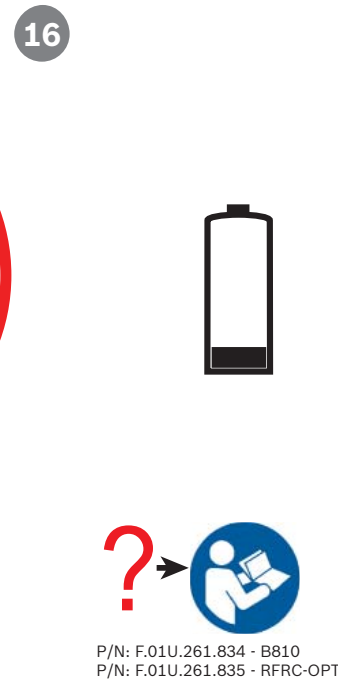
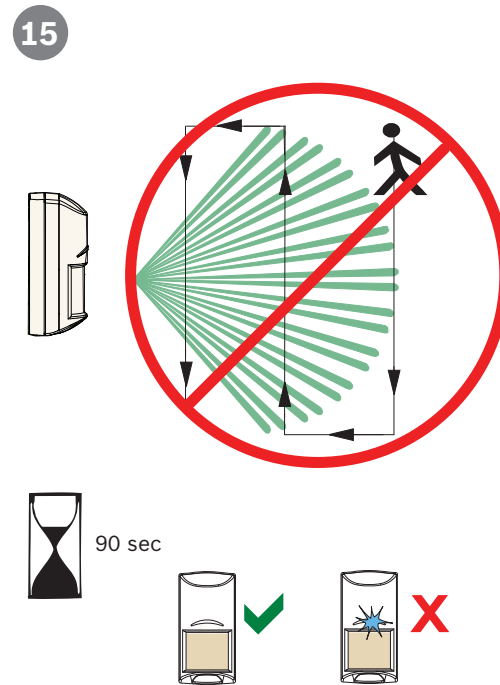
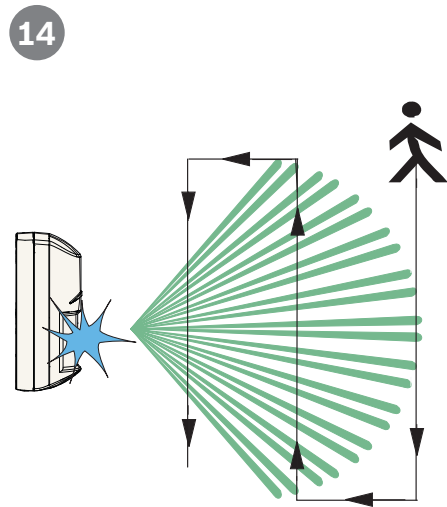
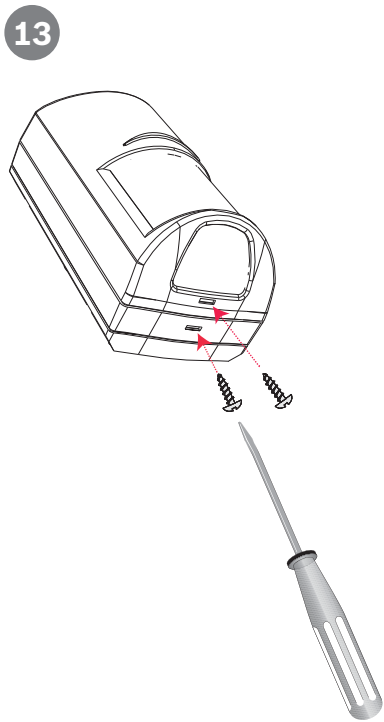
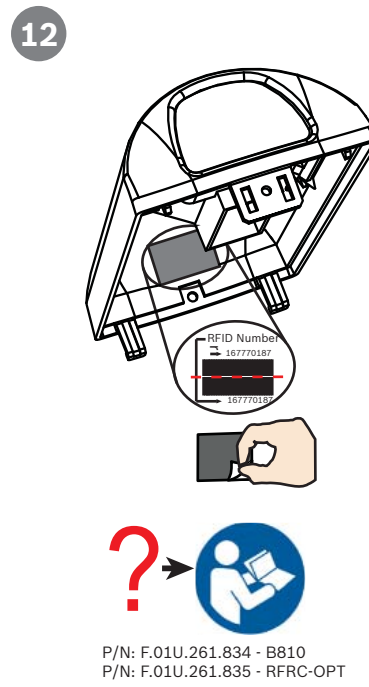
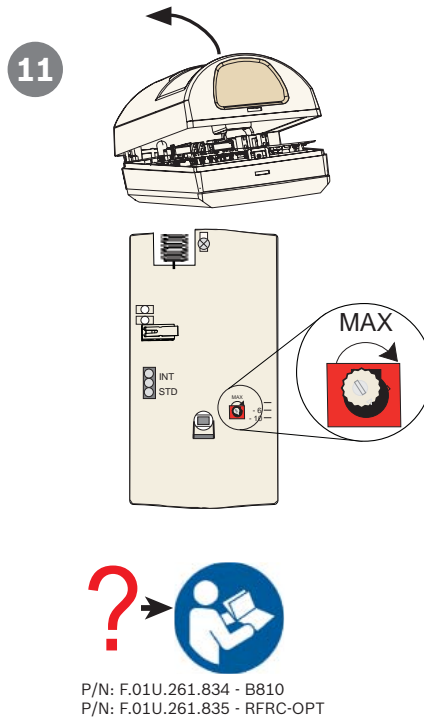
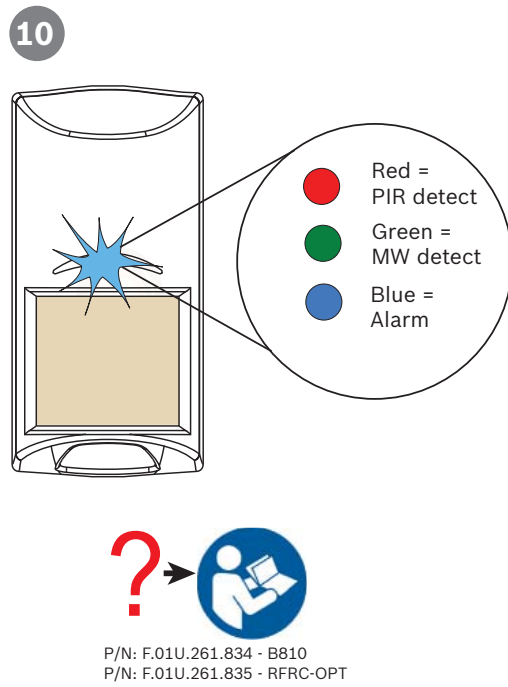
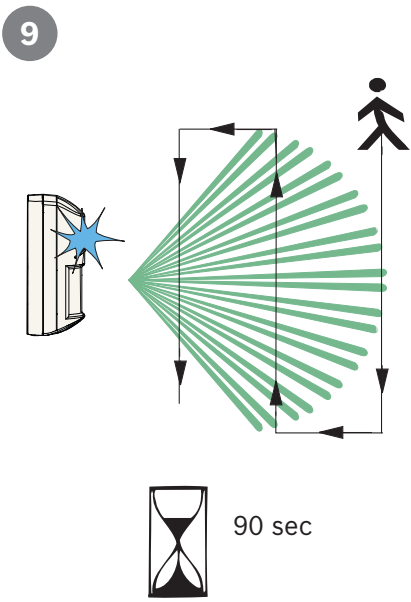

**English**

Hereby, Bosch Security Systems, declares that this intrusion detector is in compliance with the essential requirements and other relevant provisions of Directive 1999/5/EC.

**Finnish**

Bosch Security Systems vakuuttaa täten että rikosilmoitin tyyppinen laite on direktiivin 1999/5/EY oleellisten vaatimusten ja sitä koskevien direktiivin muiden ehtojen mukainen.

**Dutch**

Hierbij verklaart Bosch Security Systems dat het toestel inbraakdetector in overeenstemming is met de essentiële eisen en de andere relevante bepalingen van richtlijn 1999/5/EG. Bij deze verklaart Bosch Security Systems dat deze inbraakdetector voldoet aan de essentiële eisen en aan de overige relevante bepalingen van Richtlijn 1999/5/EC.

**French**

Par la présente Bosch Security Systems déclare que l'appareil détecteur d'intrusion est conforme aux exigences essentielles et aux autres dispositions pertinentes de la directive 1999/5/CE. Par la présente, Bosch Security Systems déclare que ce détecteur d'intrusion est conforme aux exigences essentielles et aux autres dispositions de la directive 1999/5/CE qui lui sont applicables.

**Swedish**

Härmed intygar Bosch Säkerhetssystem att denna inbrottsdetektor står i överensstämmelse med de väsentliga egenskapskrav och övriga relevanta bestämmelser som framgår av direktiv 1999/5/EG.

**Danish**

Undertegnede Bosch sikkerhedssystemer erklærer herved, at følgende udstyr Indbrudsdetektor o verholder de væsentlige krav og øvrige relevante krav i direktiv 1999/5/EF.

**German**

Hiermit erklärt Bosch Sicherheitssysteme, dass sich dieser/diese/dieses Einbruchmelder in Übereinstimmung mit den grundlegenden Anforderungen und den anderen relevanten Vorschriften der Richtlinie 1999/5/EG befindet". (BMW). Hiermit erklärt Bosch Sicherheitssysteme die Übereinstimmung des Gerätes Einbruchmelder mit den grundlegenden Anforderungen und den anderen relevanten Festlegungen der Richtlinie 1999/5/EG. (Wien).

**Greek**

ΜΕ ΤΗΝ ΠΑΡΟΥΣΑ Σύστημα ασφαλείας Bosch ΔΗΛΩΝΕΙ ΟΤΙ Ανιχνευτής εισβολής ΣΥΜΜΟΡΦΩΝΕΤΑΙ ΠΡΟΣ ΤΙΣ ΟΥΣΙΩΔΕΙΣ ΑΠΑΙΤΗΣΕΙΣ ΚΑΙ ΤΙΣ ΛΟΙΠΕΣ ΣΧΕΤΙΚΕΣ ΔΙΑΤΑΞΕΙΣ ΤΗΣ ΟΔΗΓΙΑΣ 1999/5/ΕΚ.

**Italian**

Con la presente Bosch Security Systems dichiara che questo rilevatore antintrusione è conforme ai requisiti essenziali ed alle altre disposizioni pertinenti stabilite dalla direttiva 1999/5/CE.

**Spanish**

Por medio de la presente Bosch Security Systems declara que el detector de intrusión cumple con los requisitos esenciales y cualesquiera otras disposiciones aplicables o exigibles de la Directiva 1999/5/CE.

**Portuguese**

Bosch Security Systems declara que este detector de intrusão está conforme com os requisitos essenciais e outras disposições da Directiva 1999/5/CE.

**Copyright**

This document is the intellectual property of Bosch Security Systems B.V. and is protected by copyright. All rights reserved.

**Trademarks**

All hardware and software product names used in this document are likely to be registered trademarks and must be treated accordingly.

**Bosch Security Systems B.V. product manufacturing dates**

Use the serial number located on the product label and refer to the Bosch Security Systems B.V. web site at: <http://www.boschsecurity.com/datecodes/>.

**Top View**

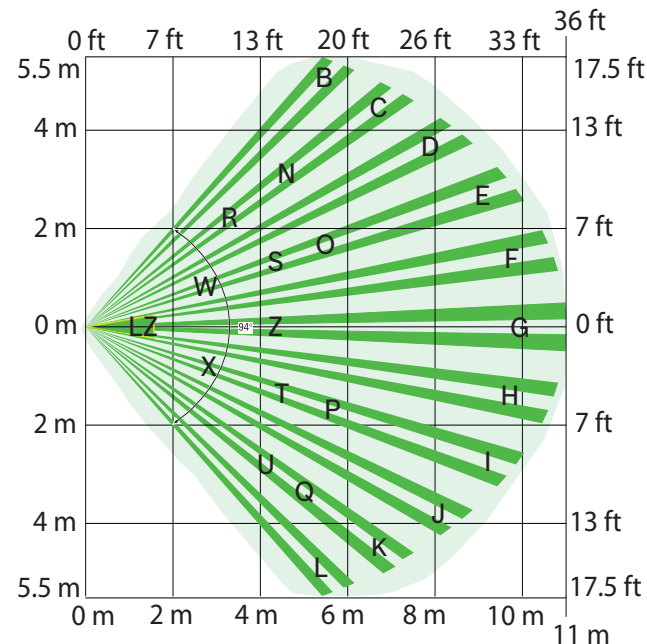

**Side View**

